



**THE DATASHEET OF  
NVATS5A302PLZT4G**



# ON Semiconductor

## Is Now

# onsemi™

To learn more about onsemi™, please visit our website at  
[www.onsemi.com](http://www.onsemi.com)

---

**onsemi** and **onsemi** and other names, marks, and brands are registered and/or common law trademarks of Semiconductor Components Industries, LLC dba "**onsemi**" or its affiliates and/or subsidiaries in the United States and/or other countries. **onsemi** owns the rights to a number of patents, trademarks, copyrights, trade secrets, and other intellectual property. A listing of **onsemi** product/patent coverage may be accessed at [www.onsemi.com/site/pdf/Patent-Marking.pdf](http://www.onsemi.com/site/pdf/Patent-Marking.pdf). **onsemi** reserves the right to make changes at any time to any products or information herein, without notice. The information herein is provided "as-is" and **onsemi** makes no warranty, representation or guarantee regarding the accuracy of the information, product features, availability, functionality, or suitability of its products for any particular purpose, nor does **onsemi** assume any liability arising out of the application or use of any product or circuit, and specifically disclaims any and all liability, including without limitation special, consequential or incidental damages. Buyer is responsible for its products and applications using **onsemi** products, including compliance with all laws, regulations and safety requirements or standards, regardless of any support or applications information provided by **onsemi**. "Typical" parameters which may be provided in **onsemi** data sheets and/or specifications can and do vary in different applications and actual performance may vary over time. All operating parameters, including "Typicals" must be validated for each customer application by customer's technical experts. **onsemi** does not convey any license under any of its intellectual property rights nor the rights of others. **onsemi** products are not designed, intended, or authorized for use as a critical component in life support systems or any FDA Class 3 medical devices or medical devices with a same or similar classification in a foreign jurisdiction or any devices intended for implantation in the human body. Should Buyer purchase or use **onsemi** products for any such unintended or unauthorized application, Buyer shall indemnify and hold **onsemi** and its officers, employees, subsidiaries, affiliates, and distributors harmless against all claims, costs, damages, and expenses, and reasonable attorney fees arising out of, directly or indirectly, any claim of personal injury or death associated with such unintended or unauthorized use, even if such claim alleges that **onsemi** was negligent regarding the design or manufacture of the part. **onsemi** is an Equal Opportunity/Affirmative Action Employer. This literature is subject to all applicable copyright laws and is not for resale in any manner. Other names and brands may be claimed as the property of others.

# NVATS5A302PLZ

## Power MOSFET

–60 V, 13 mΩ, –80 A, P-Channel



ON Semiconductor®

www.onsemi.com

Automotive Power MOSFET designed for compact and efficient designs and including high thermal performance.

AEC-Q101 qualified MOSFET and PPAP capable suitable for automotive applications.

### Features

- Low On-Resistance
- High Current Capability
- 100% Avalanche Tested
- AEC-Q101 qualified and PPAP capable
- ATPAK package is pin-compatible with DPAK (TO-252)
- Pb-Free, Halogen Free and RoHS compliance

### Typical Applications

- Reverse Battery Protection
- Load Switch
- Automotive Front Lighting
- Automotive Body Controllers

### SPECIFICATIONS

**ABSOLUTE MAXIMUM RATING** at Ta = 25°C (Note 1)

Parameter	Symbol	Value	Unit
Drain to Source Voltage	V <sub>DSS</sub>	–60	V
Gate to Source Voltage	V <sub>GSS</sub>	±20	V
Drain Current (DC)	I <sub>D</sub>	–80	A
Drain Current (Pulse) PW ≤ 10 μs, duty cycle ≤ 1%	I <sub>DP</sub>	–320	A
Power Dissipation Tc = 25°C	P <sub>D</sub>	84	W
Operating Junction and Storage Temperature	T <sub>j</sub> , T <sub>stg</sub>	–55 to +175	°C
Avalanche Energy (Single Pulse) (Note 2)	E <sub>AS</sub>	197	mJ
Avalanche Current (Note 3)	I <sub>AV</sub>	–42	A

Note 1 : Stresses exceeding those listed in the Maximum Ratings table may damage the device. If any of these limits are exceeded, device functionality should not be assumed, damage may occur and reliability may be affected.

2 : V<sub>DD</sub> = –36 V, L = 100 μH, I<sub>AV</sub> = –42 A (Fig.1)

3 : L ≤ 100 μH, Single pulse

### THERMAL RESISTANCE RATINGS

Parameter	Symbol	Value	Unit
Junction to Case Steady State (Tc = 25°C)	R <sub>θJC</sub>	1.78	°C/W
Junction to Ambient (Note 4)	R <sub>θJA</sub>	79.1	°C/W

Note 4 : Surface mounted on FR4 board using a 130 mm<sup>2</sup>, 1 oz. Cu pad.

V <sub>DSS</sub>	R <sub>DS(on)</sub> Max	I <sub>D</sub> Max
–60 V	13 mΩ @ –10 V	–80 A
	18 mΩ @ –4.5 V	

### ELECTRICAL CONNECTION P-Channel

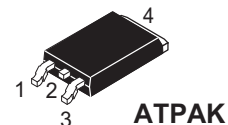
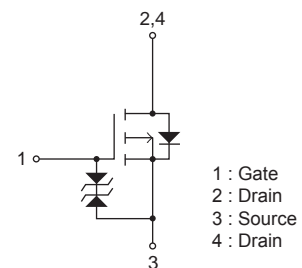

### MARKING



### ORDERING INFORMATION

See detailed ordering and shipping information on page 6 of this data sheet.

# NVATS5A302PLZ

## ELECTRICAL CHARACTERISTICS at Ta = 25°C (Note 5)

Parameter	Symbol	Conditions	Value			Unit
			min	typ	max	
Drain to Source Breakdown Voltage	V(BR)DSS	$I_D = -1 \text{ mA}, V_{GS} = 0 \text{ V}$	-60			V
Zero-Gate Voltage Drain Current	$I_{DSS}$	$V_{DS} = -60 \text{ V}, V_{GS} = 0 \text{ V}$			-10	$\mu\text{A}$
Gate to Source Leakage Current	$I_{GSS}$	$V_{GS} = \pm 16 \text{ V}, V_{DS} = 0 \text{ V}$			$\pm 10$	$\mu\text{A}$
Gate Threshold Voltage	$V_{GS(th)}$	$V_{DS} = -10 \text{ V}, I_D = -1 \text{ mA}$	-1.2		-2.6	V
Forward Transconductance	$g_{FS}$	$V_{DS} = -10 \text{ V}, I_D = -35 \text{ A}$		75		S
Static Drain to Source On-State Resistance	$R_{DS(on)1}$	$I_D = -35 \text{ A}, V_{GS} = -10 \text{ V}$		10	13	$\text{m}\Omega$
	$R_{DS(on)2}$	$I_D = -35 \text{ A}, V_{GS} = -4.5 \text{ V}$		13	18	$\text{m}\Omega$
Input Capacitance	$C_{iss}$	$V_{DS} = -20 \text{ V}, f = 1 \text{ MHz}$		5,400		pF
Output Capacitance	$C_{oss}$			500		pF
Reverse Transfer Capacitance	$C_{rss}$			370		pF
Turn-ON Delay Time	$t_{d(on)}$		See Fig.2		35	
Rise Time	$t_r$			430		ns
Turn-OFF Delay Time	$t_{d(off)}$			420		ns
Fall Time	$t_f$			500		ns
Total Gate Charge	$Q_g$	$V_{DS} = -36 \text{ V}, V_{GS} = -10 \text{ V}, I_D = -70 \text{ A}$			115	
Gate to Source Charge	$Q_{gs}$			20		nC
Gate to Drain "Miller" Charge	$Q_{gd}$			25		nC
Forward Diode Voltage	$V_{SD}$	$I_S = -70 \text{ A}, V_{GS} = 0 \text{ V}$		-1.0	-1.5	V

Note 5 : Product parametric performance is indicated in the Electrical Characteristics for the listed test conditions, unless otherwise noted. Product performance may not be indicated by the Electrical Characteristics if operated under different conditions.

**Fig.1 Unclamped Inductive Switching Test Circuit**

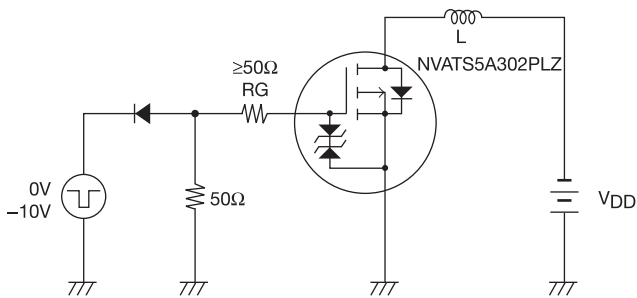

**Fig.2 Switching Time Test Circuit**

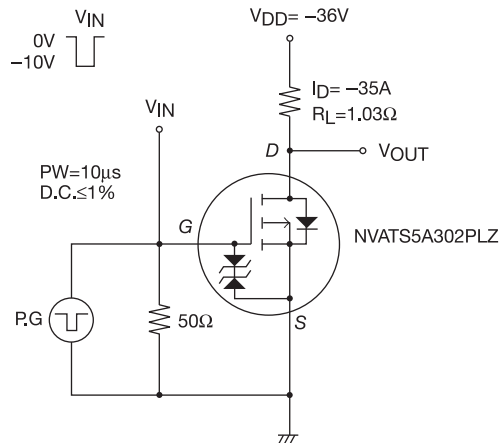

# NVATS5A302PLZ

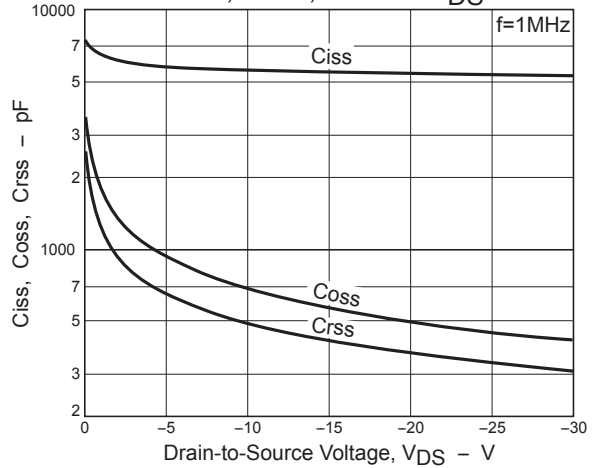
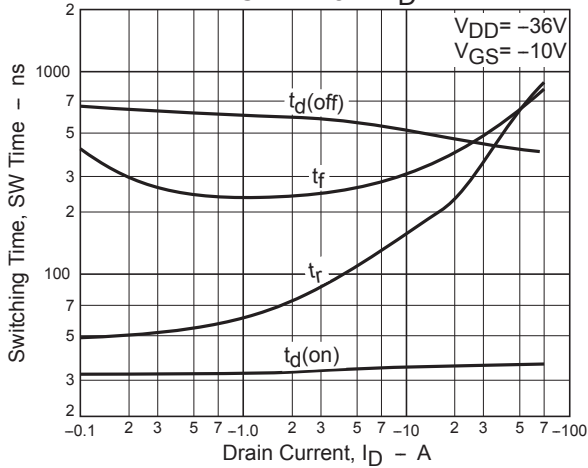
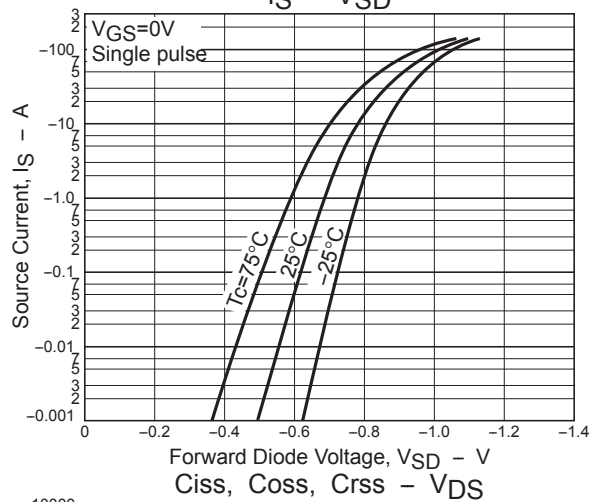
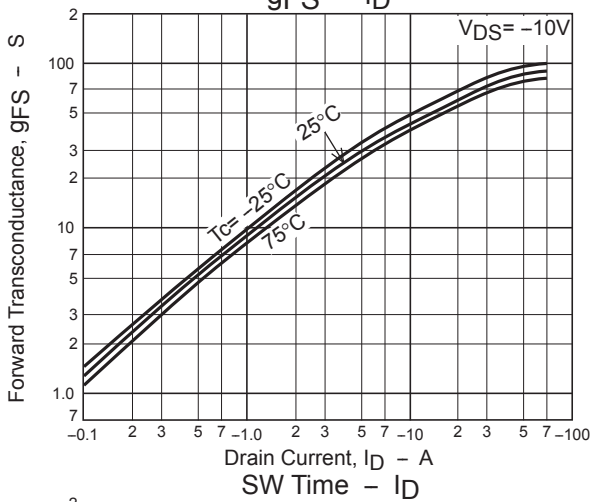
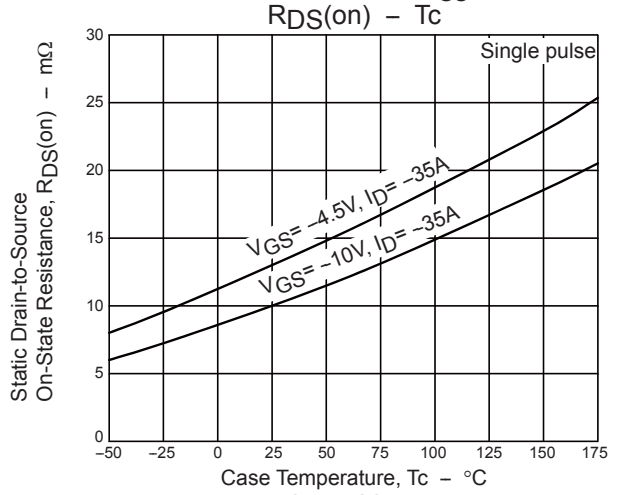
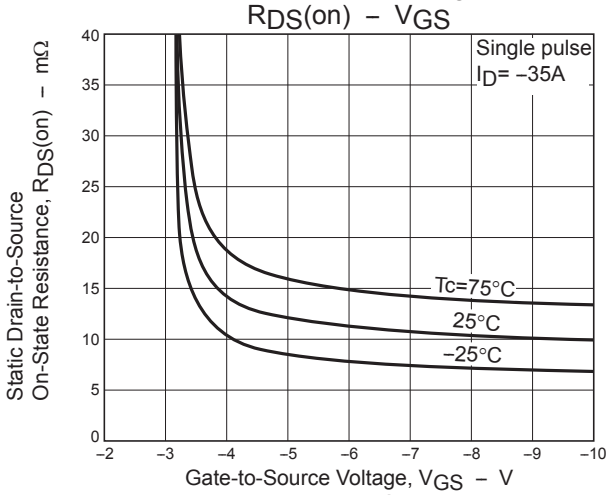
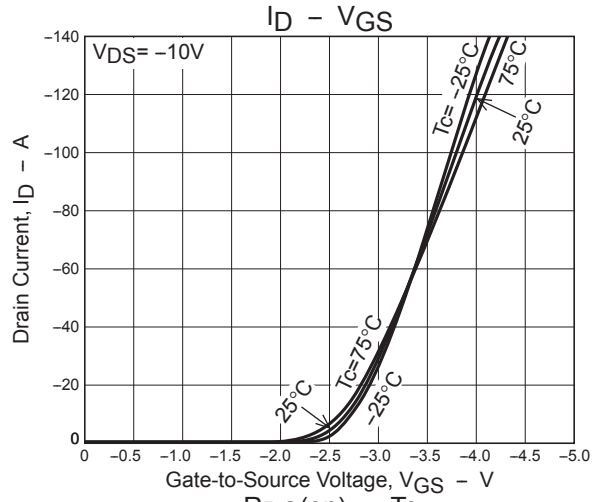
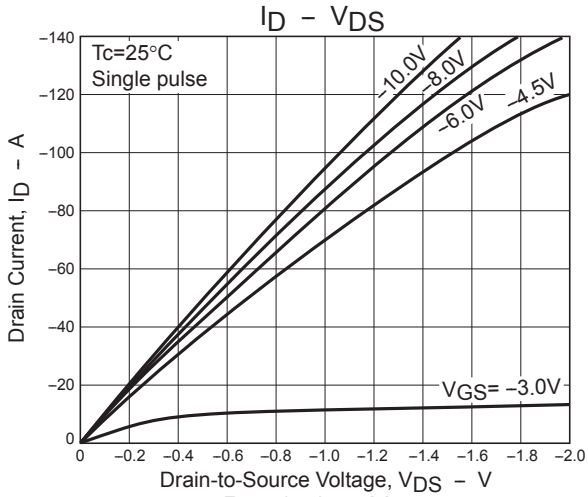

# NVATS5A302PLZ

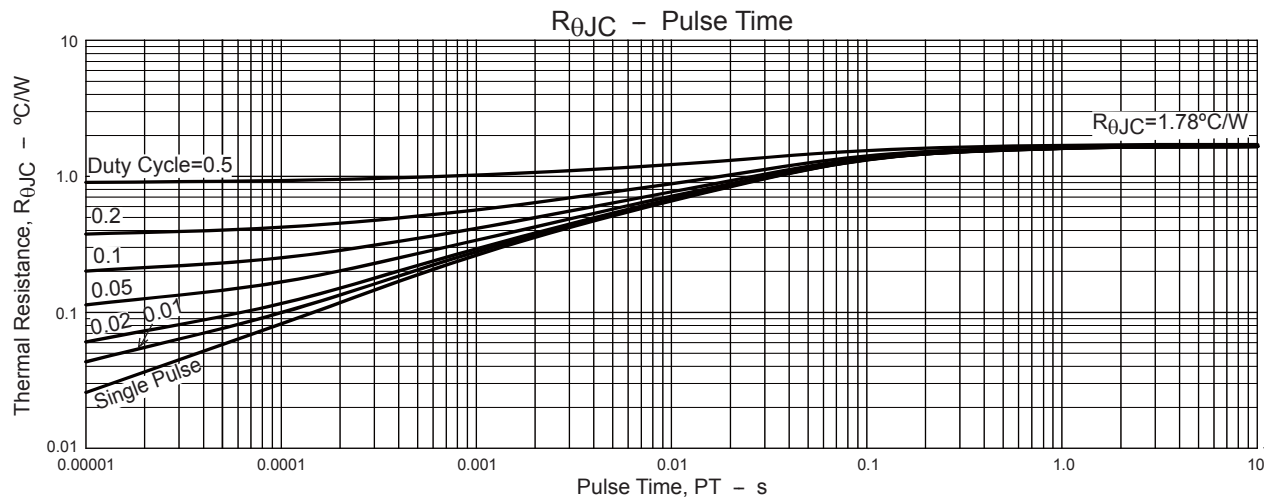
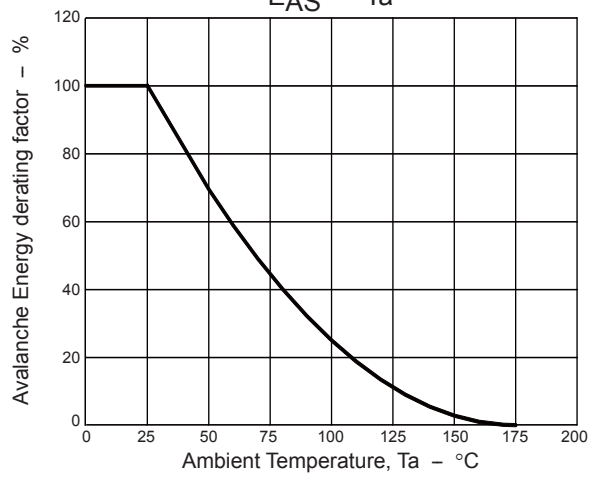
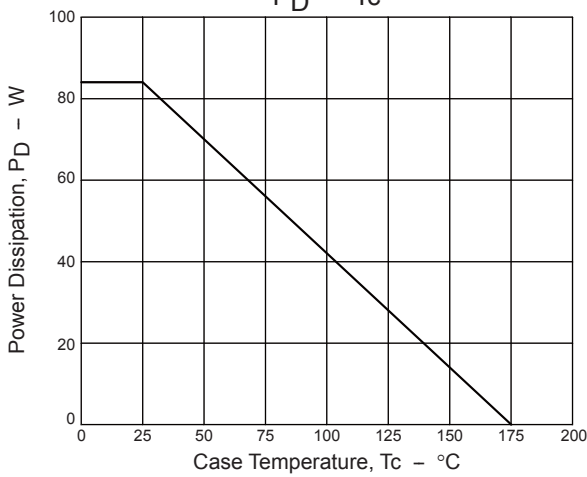
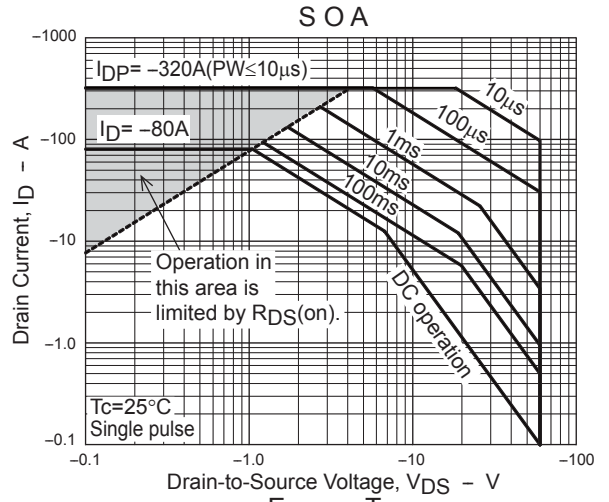
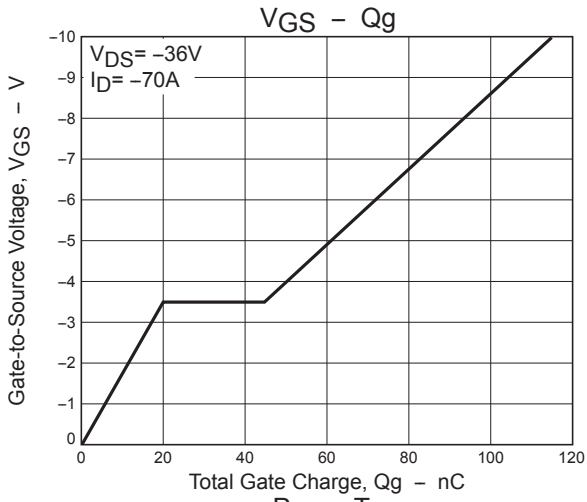

# NVATS5A302PLZ

## PACKAGE DIMENSIONS

unit : mm

### DPAK (Single Gauge) / ATPAK

CASE 369AM

ISSUE O

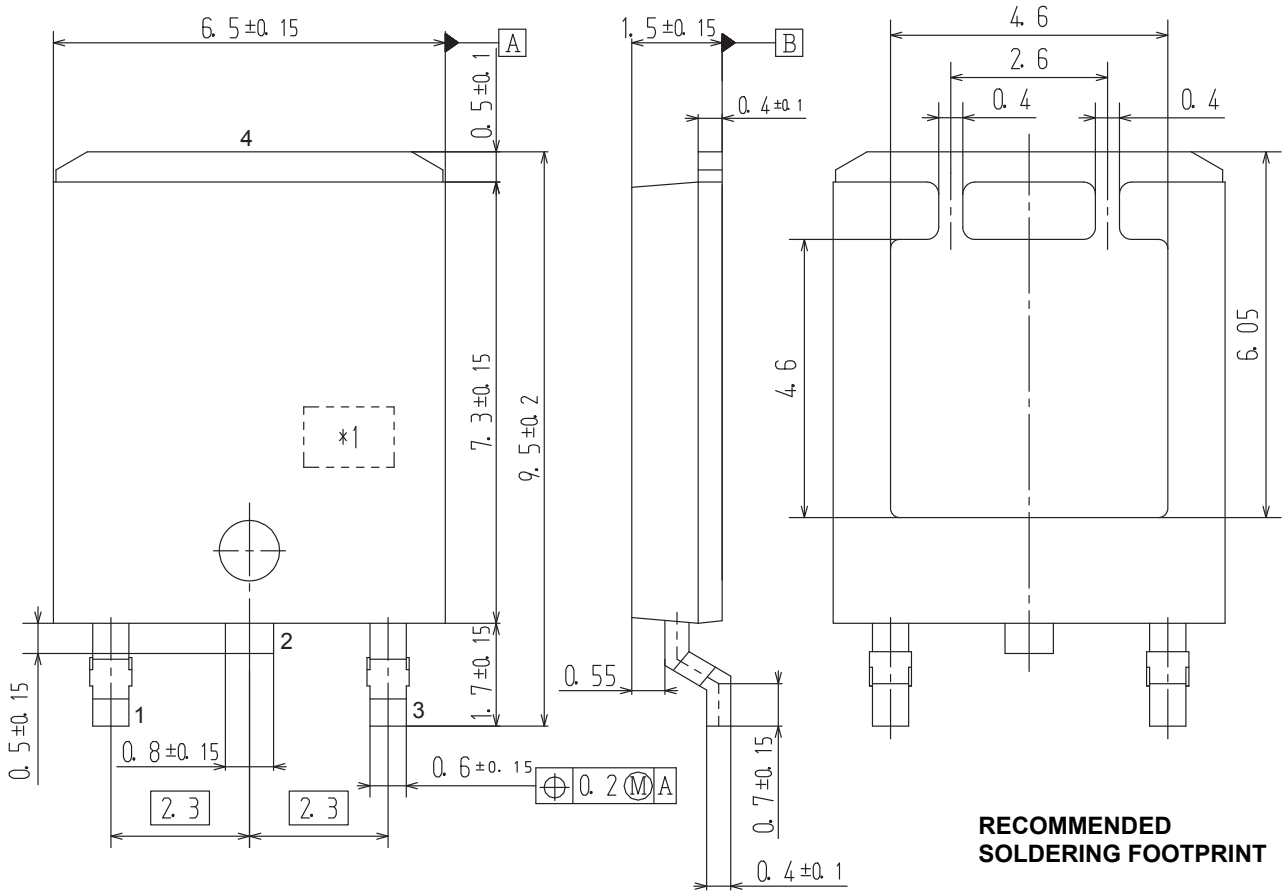

### RECOMMENDED SOLDERING FOOTPRINT

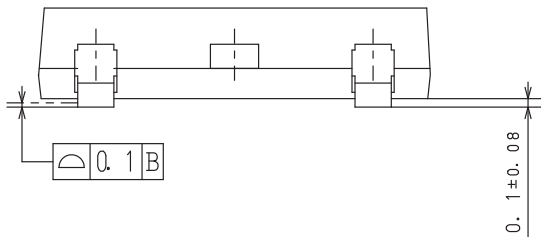

- 1 : Gate
- 2 : Drain
- 3 : Source
- 4 : Drain

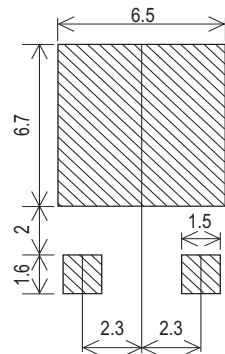

Pin2 is idle pin with electrical designation only carried

\*1: Lot indication

# NVATS5A302PLZ

## ORDERING INFORMATION

Device	Marking	Package	Shipping (Qty / Packing)
NVATS5A302PLZT4G	ATP302	DPAK(Single Gauge) / ATPAK (Pb-Free / Halogen Free)	3,000 / Tape & Reel

† For information on tape and reel specifications, including part orientation and tape sizes, please refer to our Tape and Reel Packaging Specifications Brochure, BRD8011/D. [http://www.onsemi.com/pub\\_link/Collateral/BRD8011-D.PDF](http://www.onsemi.com/pub_link/Collateral/BRD8011-D.PDF)

Note on usage : Since the NVATS5A302PLZ is a MOSFET product, please avoid using this device in the vicinity of highly charged objects.

ON Semiconductor and the ON Semiconductor logo are trademarks of Semiconductor Components Industries, LLC dba ON Semiconductor or its subsidiaries in the United States and/or other countries. ON Semiconductor owns the rights to a number of patents, trademarks, copyrights, trade secrets, and other intellectual property. A listing of ON Semiconductor's product/patent coverage may be accessed at [www.onsemi.com/site/pdf/Patent-Marking.pdf](http://www.onsemi.com/site/pdf/Patent-Marking.pdf). ON Semiconductor reserves the right to make changes without further notice to any products herein. ON Semiconductor makes no warranty, representation or guarantee regarding the suitability of its products for any particular purpose, nor does ON Semiconductor assume any liability arising out of the application or use of any product or circuit, and specifically disclaims any and all liability, including without limitation special, consequential or incidental damages. Buyer is responsible for its products and applications using ON Semiconductor products, including compliance with all laws, regulations and safety requirements or standards, regardless of any support or applications information provided by ON Semiconductor. "Typical" parameters which may be provided in ON Semiconductor data sheets and/or specifications can and do vary in different applications and actual performance may vary over time. All operating parameters, including "Typicals" must be validated for each customer application by customer's technical experts. ON Semiconductor does not convey any license under its patent rights nor the rights of others. ON Semiconductor products are not designed, intended, or authorized for use as a critical component in life support systems or any FDA Class 3 medical devices or medical devices with a same or similar classification in a foreign jurisdiction or any devices intended for implantation in the human body. Should Buyer purchase or use ON Semiconductor products for any such unintended or unauthorized application, Buyer shall indemnify and hold ON Semiconductor and its officers, employees, subsidiaries, affiliates, and distributors harmless against all claims, costs, damages, and expenses, and reasonable attorney fees arising out of, directly or indirectly, any claim of personal injury or death associated with such unintended or unauthorized use, even if such claim alleges that ON Semiconductor was negligent regarding the design or manufacture of the part. ON Semiconductor is an Equal Opportunity/Affirmative Action Employer. This literature is subject to all applicable copyright laws and is not for resale in any manner.

## Looking for pricing, stock, or lifecycle information?

Click below to explore more details on WIN SOURCE:

- ⊖ [View NVATS5A302PLZT4G on WIN SOURCE](#)
- ⊖ [ON Semiconductor Information](#)

## Optimize Your Supply Chain with WIN SOURCE Solutions

- ✓ Global Sourcing Solution
- ✓ Obsolete Management
- ✓ Cost Control Management
- ✓ Shortage Management
- ✓ Alternative Solution
- ✓ Excess Inventory Management