



**THE DATASHEET OF  
LM3490IM5X-3.3/NOPB**



# LM3490 100 mA, SOT-23, Quasi Low-Dropout Linear Voltage Regulator with Logic-Controlled ON/OFF

Check for Samples: [LM3490](#)

## FEATURES

- 3.3, 5, 12, and 15V Versions Available
- Logic-Controlled ON/OFF
- Packaged in the Tiny 5-Lead SOT-23 Package

## APPLICATIONS

- Tiny Alternative to LM78LXX Series and Similar Devices
- Tiny 5V±5% to 3.3V, 100 mA Converter
- Post Regulator for Switching DC/DC Converter
- Bias Supply for Analog Circuits

## KEY SPECIFICATIONS

- 30V Maximum Input for Operation
- 1.2V Specified Maximum Dropout over Full Load and Temperature Ranges
- 100 mA Specified Load Current
- ±5% Specified Output Voltage Tolerance over Full Load and Temperature Ranges
- -40 to +125°C Junction Temperature Range for Operation

## Typical Application Circuit

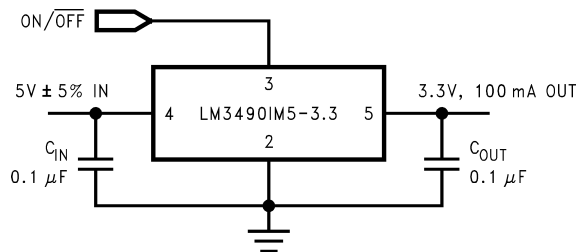

## DESCRIPTION

The LM3490 is an integrated linear voltage regulator. It features operation from an input as high as 30V and a specified maximum dropout of 1.2V at the full 100 mA load. Standard packaging for the LM3490 is the 5-lead SOT-23 package. A logic-controlled ON/OFF feature makes the LM3490 ideal for powering subsystems ON and OFF as needed.

The 5, 12, and 15V members of the LM3490 series are intended as tiny alternatives to industry standard LM78LXX series and similar devices. The 1.2V quasi low dropout of LM3490 series devices makes them a nice fit in many applications where the 2 to 2.5V dropout of LM78LXX series devices precludes their (LM78LXX series devices) use.

The LM3490 series features a 3.3V member. The SOT packaging and quasi low dropout features of the LM3490 series converge in this device to provide a very nice, very tiny 3.3V, 100 mA bias supply that regulates directly off the system 5V±5% power supply.

## Connection Diagram

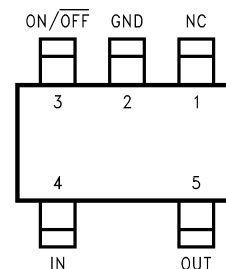

**Figure 1. Top View  
SOT-23 Package  
5-Lead, Molded-Plastic Small-Outline Transistor  
(SOT) Package  
Package Code DBV0005A**



Please be aware that an important notice concerning availability, standard warranty, and use in critical applications of Texas Instruments semiconductor products and disclaimers thereto appears at the end of this data sheet.

All trademarks are the property of their respective owners.



These devices have limited built-in ESD protection. The leads should be shorted together or the device placed in conductive foam during storage or handling to prevent electrostatic damage to the MOS gates.

## ABSOLUTE MAXIMUM RATINGS<sup>(1)(2)</sup>

Input Voltage (IN to GND)		35V
Voltage ON/OFF to GND		5.5V
Power Dissipation <sup>(3)</sup>		400 mW
Junction Temp. (T <sub>J</sub> ) <sup>(3)</sup>		+150°C
Ambient Storage Temp.		-65 to +150°C
Soldering Time, Temp. <sup>(4)</sup>	Wave	4sec., 260°C
	Infrared	10sec., 240°C
	Vapor Phase	75sec., 219°C
ESD <sup>(5)</sup>	ON/OFF	1.0kV
	All Other Pins	2.0kV

- (1) Absolute Maximum Ratings are limits beyond which damage to the device may occur. Operating Ratings are conditions under which operation of the device is specified. Operating Ratings do not imply ensured performance limits. For ensured performance limits and associated test conditions, see the Electrical Characteristics tables.
- (2) If Military/Aerospace specified devices are required, please contact the Texas Instruments Sales Office/Distributors for availability and specifications.
- (3) The Absolute Maximum power dissipation depends on the ambient temperature and can be calculated using  $P = (T_J - T_A)/\theta_{JA}$  where  $T_J$  is the junction temperature,  $T_A$  is the ambient temperature, and  $\theta_{JA}$  is the junction-to-ambient thermal resistance. The 400 mW rating results from substituting the Absolute Maximum junction temperature, 150°C, for  $T_J$ , 50°C for  $T_A$ , and 250°C/W for  $\theta_{JA}$ . More power can be safely dissipated at lower ambient temperatures. Less power can be safely dissipated at higher ambient temperatures. The Absolute Maximum power dissipation can be increased by 4 mW for each °C below 50°C ambient. It must be derated by 4 mW for each °C above 50°C ambient. A  $\theta_{JA}$  of 250°C/W represents the worst-case condition of no heat sinking of the 5-lead plastic SOT-23 package. Heat sinking enables the safe dissipation of more power. The LM3490 actively limits its junction temperature to about 150°C.
- (4) Times shown are dwell times. Temperatures shown are dwell temperatures. For detailed information on soldering plastic small-outline packages, see <http://www.ti.com>.
- (5) For testing purposes, ESD was applied using the human-body model, a 100 pF capacitor discharged through a 1.5 kΩ resistor.

## OPERATING RATINGS<sup>(1)</sup>

Maximum Input Voltage (IN to GND)		30V
Voltage ON/OFF to GND		0 to 5V
Junction Temperature (T <sub>J</sub> )		-40 to +125°C
Maximum Power Dissipation <sup>(2)</sup>		300 mW

- (1) Absolute Maximum Ratings are limits beyond which damage to the device may occur. Operating Ratings are conditions under which operation of the device is specified. Operating Ratings do not imply ensured performance limits. For ensured performance limits and associated test conditions, see the Electrical Characteristics tables.
- (2) As with the Absolute Maximum power dissipation, the maximum power dissipation for operation depends on the ambient temperature. The 300 mW rating appearing under Operating Ratings results from substituting the maximum junction temperature for operation, 125°C, for  $T_J$ , 50°C for  $T_A$ , and 250°C/W for  $\theta_{JA}$  in  $P = (T_J - T_A)/\theta_{JA}$ . More power can be dissipated at lower ambient temperatures. Less power can be dissipated at higher ambient temperatures. The maximum power dissipation for operation appearing under Operating Ratings can be increased by 4 mW for each °C below 50°C ambient. It must be derated by 4 mW for each °C above 50°C ambient. A  $\theta_{JA}$  of 250°C/W represents the worst-case condition of no heat sinking of the 5-lead plastic SOT-23 package. Heat sinking enables the dissipation of more power during operation.

**ELECTRICAL CHARACTERISTICS LM3490-3.3, LM3490-5.0**

$V_{IN} = V_{NOM} + 1.5V$  unless otherwise noted. Typical and limits appearing in normal type apply for  $T_A = T_J = 25^\circ C$ . Limits appearing in boldface type apply over the entire junction temperature range for operation,  $-40$  to  $+125^\circ C$ <sup>(1)(2)(3)</sup>

Nominal Output Voltage ( $V_{NOM}$ )			3.3V		5.0V		Units
Symbol	Parameter	Conditions	Typical	Limit	Typical	Limit	
$V_{OUT}$	Output Voltage	$1\text{ mA} \leq I_{OUT} \leq 100\text{ mA}$	3.30	3.17 <b>3.14</b> 3.43 <b>3.46</b>	5.00	4.80 <b>4.75</b> 5.20 <b>5.25</b>	V V(min) V(min) V(max) V(max)
$\Delta V_{OUT}$	Line Regulation	$V_{NOM} + 1.5V \leq V_{IN} \leq 30V$ , $I_{OUT} = 1\text{ mA}$	7	<b>25</b>	9	<b>25</b>	mV mV(max)
$\Delta V_{OUT}$	Load Regulation	$10\text{ mA} \leq I_{OUT} \leq 100\text{ mA}$	15	<b>40</b>	15	<b>40</b>	mV mV(max)
$I_{GND}$	Ground Pin Current	$V_{NOM} + 1.5V \leq V_{IN} \leq 30V$ , No Load					
		$V_{ON/OFF} = 5V$	2	<b>4</b>	2	<b>4</b>	mA mA(max)
		$V_{ON/OFF} = 0V$	0.1	<b>5</b>	0.1	<b>5</b>	$\mu A$ $\mu A$ (max)
$V_{IN} - V_{OUT}$	Dropout Voltage	$I_{OUT} = 10\text{ mA}$	0.7	0.9 <b>1.0</b>	0.7	0.9 <b>1.0</b>	V V(max) V(max)
		$I_{OUT} = 100\text{ mA}$	0.9	1.1 <b>1.2</b>	0.9	1.1 <b>1.2</b>	V V(max) V(max)
$e_n$	Output Noise Voltage	$V_{IN} = 10V$ , Bandwidth: 10 Hz to 100 kHz	100		150		$\mu V_{rms}$
$V_{IL}$	Maximum Low Level Input Voltage at ON/OFF			<b>0.2</b>		<b>0.2</b>	V(max)
$V_{IH}$	Minimum High Level Input Voltage at ON/OFF			<b>2.0</b>		<b>2.0</b>	V(min)
$I_{IL}$		$V_{ON/OFF} = 0V$		<b>-1</b>		<b>-1</b>	$\mu A$ (max)
$I_{IH}$		$V_{ON/OFF} = 5V$	1	<b>20</b>	1	<b>20</b>	$\mu A$ $\mu A$ (max)

- (1) A typical is the center of characterization data taken with  $T_A = T_J = 25^\circ C$ . Typical values are not ensured.
- (2) All limits are specified. All electrical characteristics having room-temperature limits are tested during production with  $T_A = T_J = 25^\circ C$ . All hot and cold limits are specified by correlating the electrical characteristics to process and temperature variations and applying statistical process control.
- (3) All voltages except dropout are with respect to the voltage at the GND pin.

## ELECTRICAL CHARACTERISTICS LM3490-12, LM3490-15

$V_{IN} = V_{NOM} + 1.5V$  unless otherwise noted. Typical and limits appearing in normal type apply for  $T_A = T_J = 25^\circ C$ . Limits appearing in boldface type apply over the entire junction temperature range for operation,  $-40$  to  $+125^\circ C$ <sup>(1)(2)(3)</sup>

Nominal Output Voltage ( $V_{NOM}$ )			12V		15V		Units
Symbol	Parameter	Conditions	Typical	Limit	Typical	Limit	
$V_{OUT}$	Output Voltage	$1\text{ mA} \leq I_{OUT} \leq 100\text{ mA}$	12.00	11.52 <b>11.40</b> 12.48 <b>12.60</b>	15.00	14.40 <b>14.25</b> 15.60 <b>15.75</b>	V V(min) V(min) V(max) V(max)
$\Delta V_{OUT}$	Line Regulation	$V_{NOM} + 1.5V \leq V_{IN} \leq 30V$ , $I_{OUT} = 1\text{ mA}$	14	<b>40</b>	16	<b>40</b>	mV mV(max)
$\Delta V_{OUT}$	Load Regulation	$10\text{ mA} \leq I_{OUT} \leq 100\text{ mA}$	36	<b>60</b>	45	<b>75</b>	mV mV(max)
$I_{GND}$	Ground Pin Current	$V_{NOM} + 1.5V \leq V_{IN} \leq 30V$ , No Load					
		$V_{ON/OFF} = 5V$	2	<b>4</b>	2	<b>4</b>	mA mA(max)
		$V_{ON/OFF} = 0V$	0.1	<b>5</b>	0.1	<b>5</b>	$\mu A$ $\mu A$ (max)
$V_{IN} - V_{OUT}$	Dropout Voltage	$I_{OUT} = 10\text{ mA}$	0.7	0.9 <b>1.0</b>	0.7	0.9 <b>1.0</b>	V V(max) V(max)
		$I_{OUT} = 100\text{ mA}$	0.9	1.1 <b>1.2</b>	0.9	1.1 <b>1.2</b>	V V(max) V(max)
$e_n$	Output Noise Voltage	$V_{IN} = 10V$ , Bandwidth: 10 Hz to 100 kHz	360		450		$\mu V_{rms}$
$V_{IL}$	Maximum Low Level Input Voltage at ON/OFF			<b>0.2</b>		<b>0.2</b>	V(max)
$V_{IH}$	Minimum High Level Input Voltage at ON/OFF			<b>2.0</b>		<b>2.0</b>	V(min)
$I_{IL}$		$V_{ON/OFF} = 0V$		<b>-1</b>		<b>-1</b>	$\mu A$ (max)
$I_{IH}$		$V_{ON/OFF} = 5V$	1	<b>20</b>	1	<b>20</b>	$\mu A$ $\mu A$ (max)

- (1) A typical is the center of characterization data taken with  $T_A = T_J = 25^\circ C$ . Typical values are not ensured.
- (2) All limits are specified. All electrical characteristics having room-temperature limits are tested during production with  $T_A = T_J = 25^\circ C$ . All hot and cold limits are specified by correlating the electrical characteristics to process and temperature variations and applying statistical process control.
- (3) All voltages except dropout are with respect to the voltage at the GND pin.

**TYPICAL PERFORMANCE CHARACTERISTICS**

Unless indicated otherwise,  $V_{IN} = V_{NOM} + 1.5V$ ,  $C_{IN} = 0.1 \mu F$ ,  $C_{OUT} = 0.1 \mu F$ , and  $T_A = 25^\circ C$ .

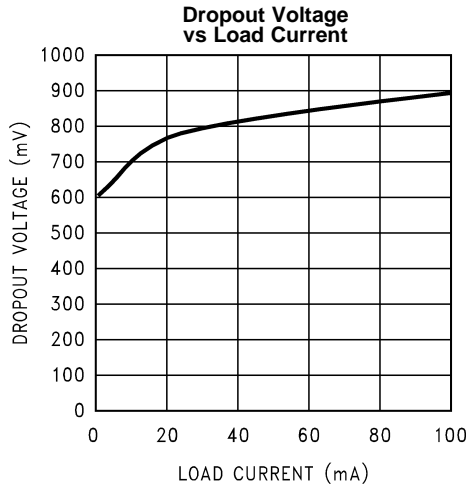

Figure 2.

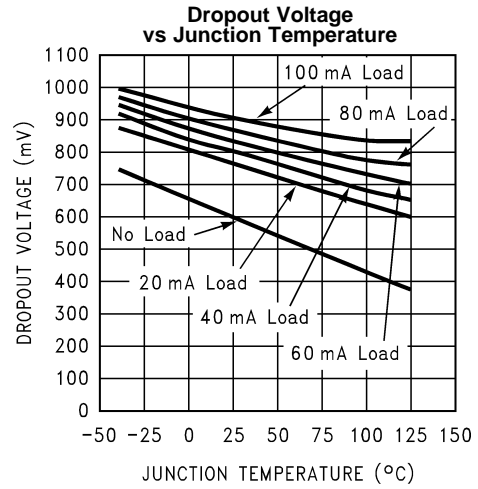

Figure 3.

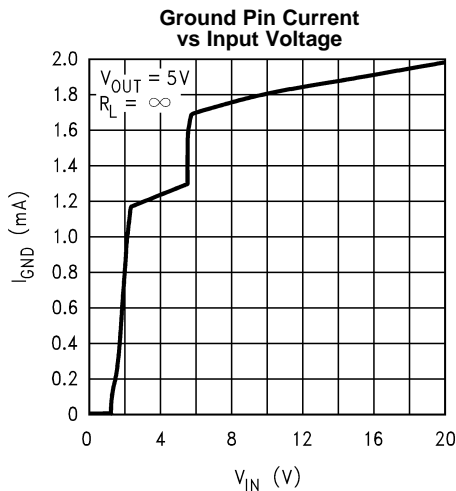

Figure 4.

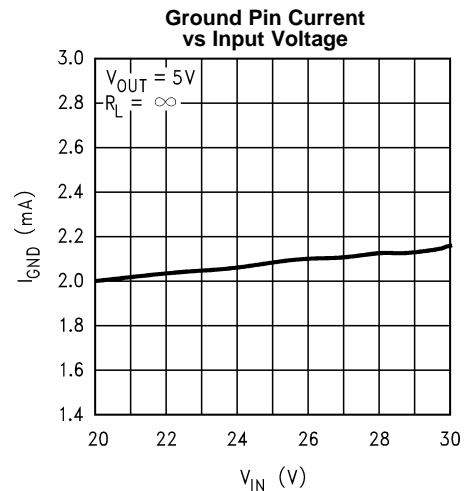

Figure 5.

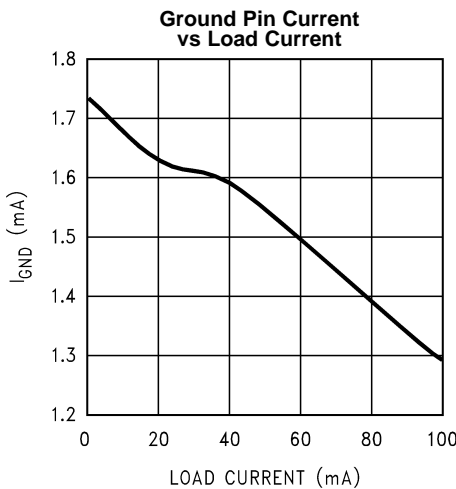

Figure 6.

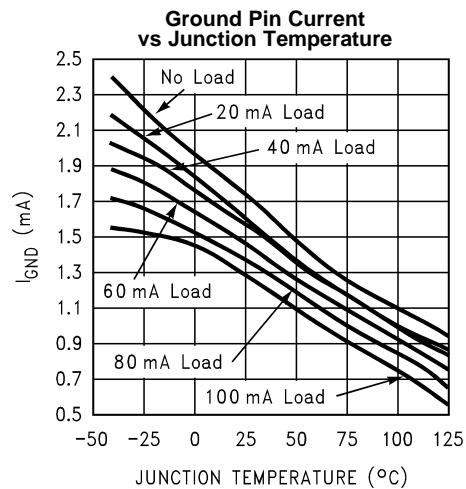

Figure 7.

**TYPICAL PERFORMANCE CHARACTERISTICS (continued)**

Unless indicated otherwise,  $V_{IN} = V_{NOM} + 1.5V$ ,  $C_{IN} = 0.1 \mu F$ ,  $C_{OUT} = 0.1 \mu F$ , and  $T_A = 25^\circ C$ .

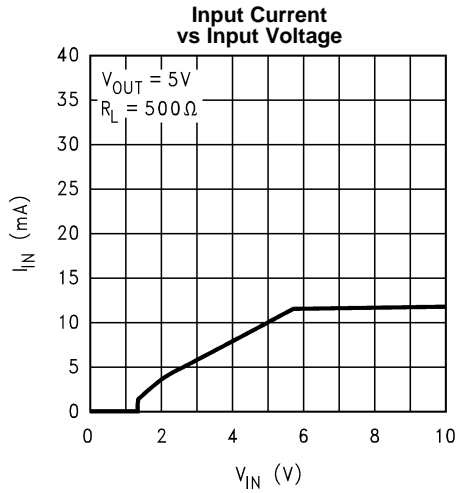

Figure 8.

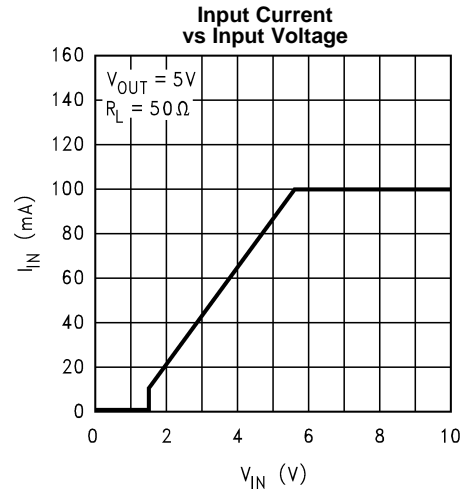
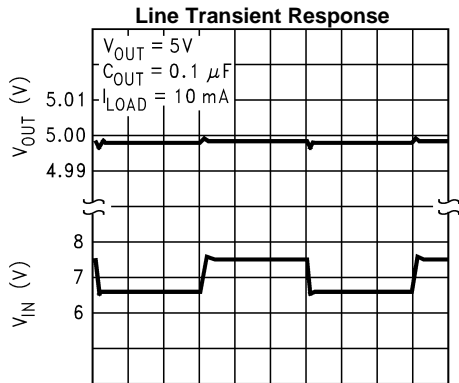
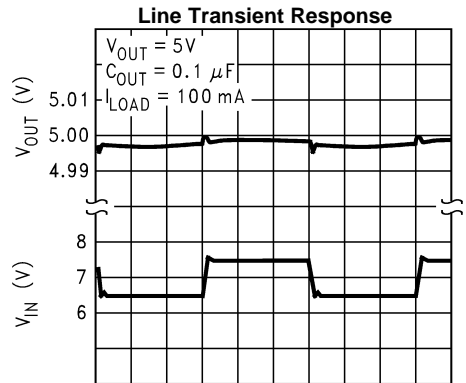

Figure 9.



200  $\mu s/Div$   
 Figure 10.



200  $\mu s/Div$   
 Figure 11.

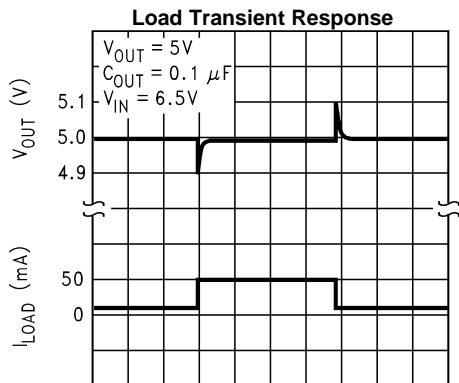

50  $\mu s/Div$   
 Figure 12.

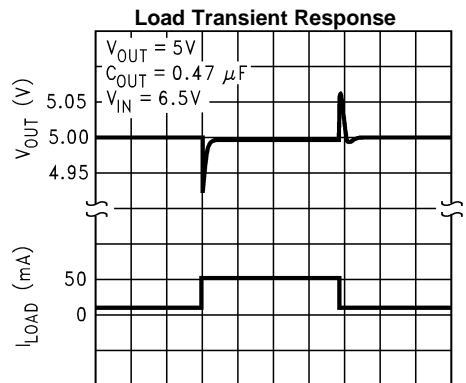

50  $\mu s/Div$   
 Figure 13.

**TYPICAL PERFORMANCE CHARACTERISTICS (continued)**

Unless indicated otherwise,  $V_{IN} = V_{NOM} + 1.5V$ ,  $C_{IN} = 0.1 \mu F$ ,  $C_{OUT} = 0.1 \mu F$ , and  $T_A = 25^\circ C$ .

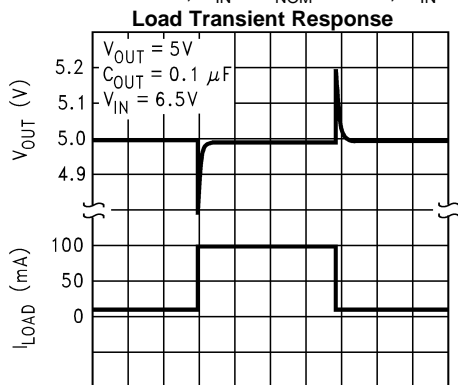

50  $\mu s$ /Div  
Figure 14.

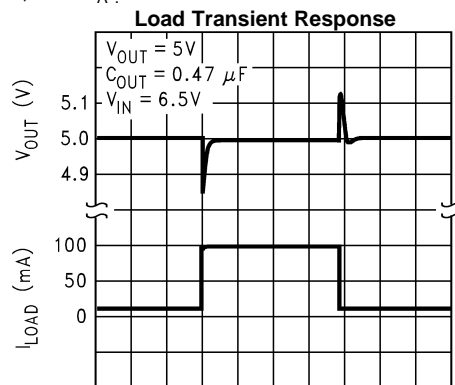

50  $\mu s$ /Div  
Figure 15.

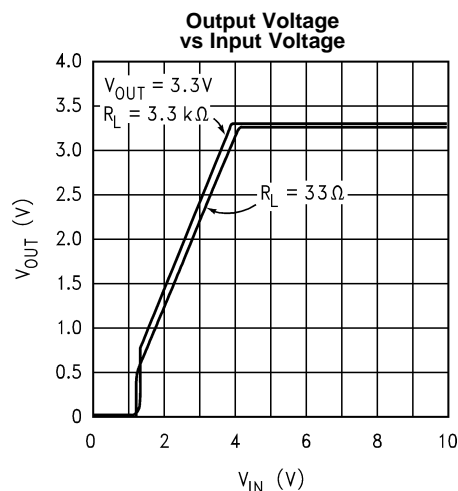

Figure 16.

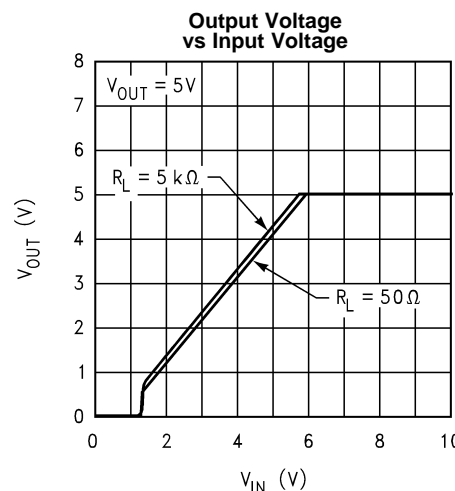

Figure 17.

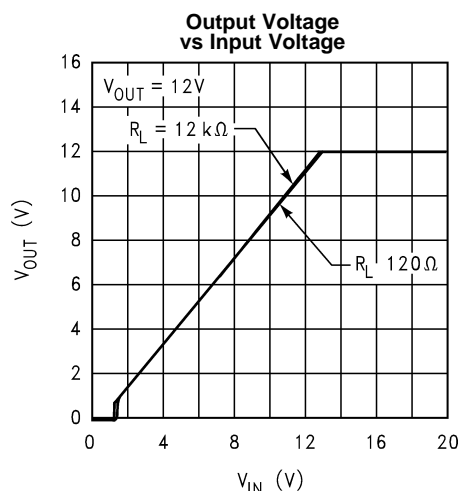

Figure 18.

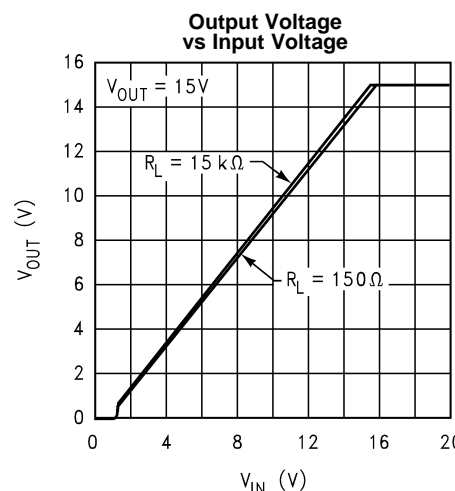

Figure 19.

**TYPICAL PERFORMANCE CHARACTERISTICS (continued)**

Unless indicated otherwise,  $V_{IN} = V_{NOM} + 1.5V$ ,  $C_{IN} = 0.1 \mu F$ ,  $C_{OUT} = 0.1 \mu F$ , and  $T_A = 25^\circ C$ .

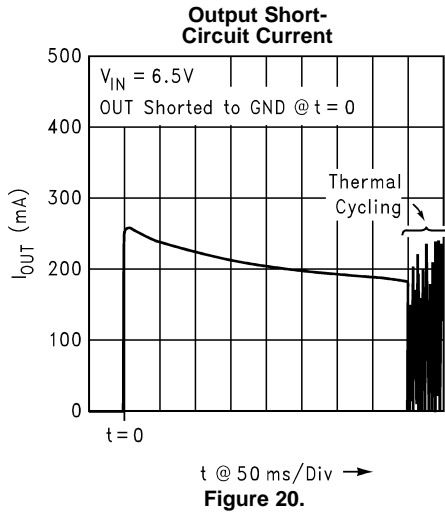

Figure 20.

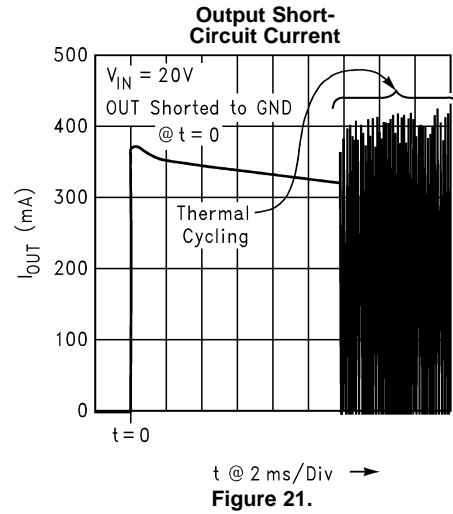

Figure 21.

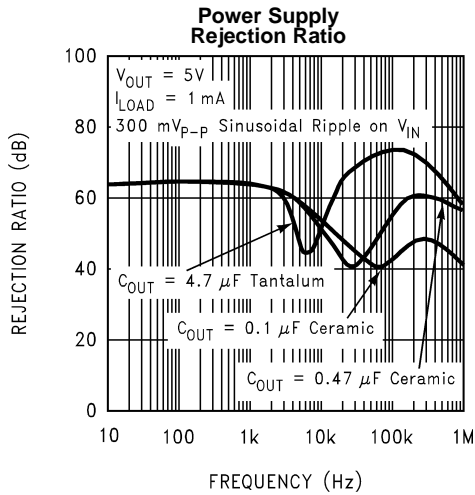

Figure 22.

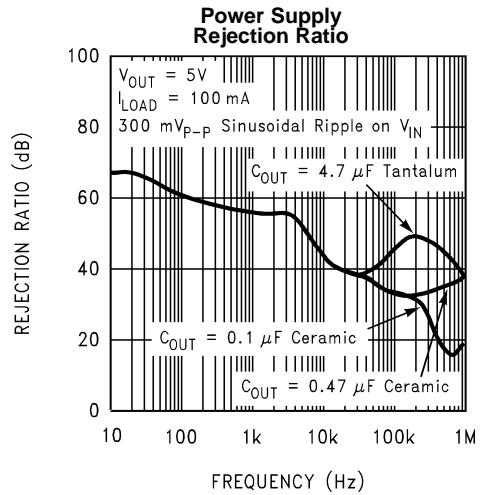

Figure 23.

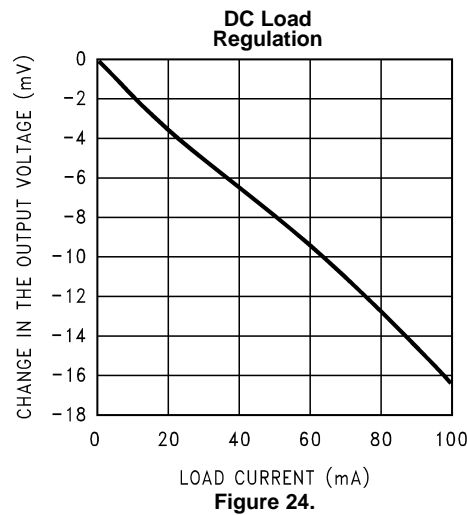

Figure 24.

## APPLICATIONS INFORMATION

### ON/OFF Pin

The LM3490 features a logic controlled ON/OFF pin that will allow the output voltage to be disabled, or enabled, as needed. The defined operating voltage range for this pin is 0.0V to 5.0V. The ON/OFF pin can not be left floating, as the output status cannot be ensured. Additionally, the ON/OFF pin should not be biased below ground potential as unpredictable device behavior may occur.

Pulling the ON/OFF pin voltage to a value between the  $V_{IH}$  threshold and 5.0V will enable the output voltage. Pulling the ON/OFF pin voltage to a value between the  $V_{IL}$  threshold and Ground potential will disable the output voltage. Although the ON/OFF threshold is typically 725mV, and has no hysteresis, the ON/OFF signal must rise and fall, cleanly and promptly, from voltage levels that are below the  $V_{IL}$  threshold and above the  $V_{IH}$  threshold.

The ON/OFF pin has no internal pull-up or pull-down to establish a default condition and, as a result, this pin must be terminated, either actively or passively, to an appropriate voltage level.

### REVISION HISTORY

Changes from Revision D (April 2013) to Revision E	Page
• Changed layout of National Data Sheet to TI format .....	<a href="#">9</a>

**PACKAGING INFORMATION**

Orderable Device	Status (1)	Package Type	Package Drawing	Pins	Package Qty	Eco Plan (2)	Lead/Ball Finish (6)	MSL Peak Temp (3)	Op Temp (°C)	Device Marking (4/5)	Samples
LM3490IM5-12	LIFEBUY	SOT-23	DBV	5	1000	TBD	Call TI	Call TI	-40 to 125	L80B	
LM3490IM5-12/NOPB	LIFEBUY	SOT-23	DBV	5	1000	Green (RoHS & no Sb/Br)	CU SN	Level-1-260C-UNLIM	-40 to 125	L80B	
LM3490IM5-3.3	LIFEBUY	SOT-23	DBV	5	1000	TBD	Call TI	Call TI	-40 to 125	L78B	
LM3490IM5-3.3/NOPB	LIFEBUY	SOT-23	DBV	5	1000	Green (RoHS & no Sb/Br)	CU SN	Level-1-260C-UNLIM	-40 to 125	L78B	
LM3490IM5-5.0/NOPB	LIFEBUY	SOT-23	DBV	5	1000	Green (RoHS & no Sb/Br)	CU SN	Level-1-260C-UNLIM	-40 to 125	L79B	
LM3490IM5X-12/NOPB	LIFEBUY	SOT-23	DBV	5	3000	Green (RoHS & no Sb/Br)	CU SN	Level-1-260C-UNLIM	-40 to 125	L80B	
LM3490IM5X-5.0/NOPB	LIFEBUY	SOT-23	DBV	5	3000	Green (RoHS & no Sb/Br)	CU SN	Level-1-260C-UNLIM	-40 to 125	L79B	

(1) The marketing status values are defined as follows:

**ACTIVE:** Product device recommended for new designs.

**LIFEBUY:** TI has announced that the device will be discontinued, and a lifetime-buy period is in effect.

**NRND:** Not recommended for new designs. Device is in production to support existing customers, but TI does not recommend using this part in a new design.

**PREVIEW:** Device has been announced but is not in production. Samples may or may not be available.

**OBSOLETE:** TI has discontinued the production of the device.

(2) Eco Plan - The planned eco-friendly classification: Pb-Free (RoHS), Pb-Free (RoHS Exempt), or Green (RoHS & no Sb/Br) - please check <http://www.ti.com/productcontent> for the latest availability information and additional product content details.

**TBD:** The Pb-Free/Green conversion plan has not been defined.

**Pb-Free (RoHS):** TI's terms "Lead-Free" or "Pb-Free" mean semiconductor products that are compatible with the current RoHS requirements for all 6 substances, including the requirement that lead not exceed 0.1% by weight in homogeneous materials. Where designed to be soldered at high temperatures, TI Pb-Free products are suitable for use in specified lead-free processes.

**Pb-Free (RoHS Exempt):** This component has a RoHS exemption for either 1) lead-based flip-chip solder bumps used between the die and package, or 2) lead-based die adhesive used between the die and leadframe. The component is otherwise considered Pb-Free (RoHS compatible) as defined above.

**Green (RoHS & no Sb/Br):** TI defines "Green" to mean Pb-Free (RoHS compatible), and free of Bromine (Br) and Antimony (Sb) based flame retardants (Br or Sb do not exceed 0.1% by weight in homogeneous material)

(3) MSL, Peak Temp. - The Moisture Sensitivity Level rating according to the JEDEC industry standard classifications, and peak solder temperature.

(4) There may be additional marking, which relates to the logo, the lot trace code information, or the environmental category on the device.

(5) Multiple Device Markings will be inside parentheses. Only one Device Marking contained in parentheses and separated by a "~" will appear on a device. If a line is indented then it is a continuation of the previous line and the two combined represent the entire Device Marking for that device.

<sup>(6)</sup> Lead/Ball Finish - Orderable Devices may have multiple material finish options. Finish options are separated by a vertical ruled line. Lead/Ball Finish values may wrap to two lines if the finish value exceeds the maximum column width.

**Important Information and Disclaimer:** The information provided on this page represents TI's knowledge and belief as of the date that it is provided. TI bases its knowledge and belief on information provided by third parties, and makes no representation or warranty as to the accuracy of such information. Efforts are underway to better integrate information from third parties. TI has taken and continues to take reasonable steps to provide representative and accurate information but may not have conducted destructive testing or chemical analysis on incoming materials and chemicals. TI and TI suppliers consider certain information to be proprietary, and thus CAS numbers and other limited information may not be available for release.

In no event shall TI's liability arising out of such information exceed the total purchase price of the TI part(s) at issue in this document sold by TI to Customer on an annual basis.

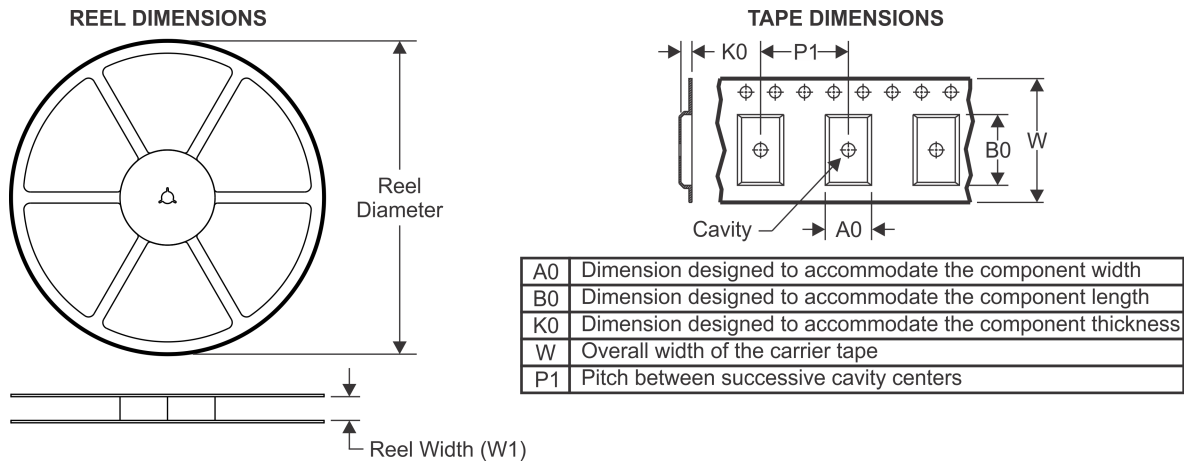
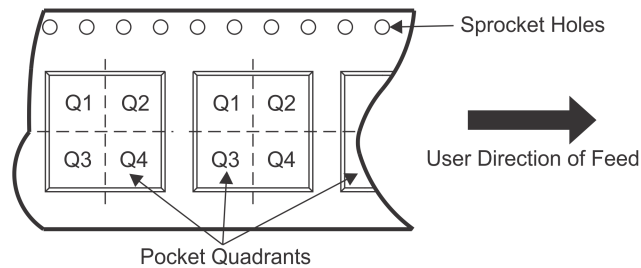
**TAPE AND REEL INFORMATION**

**QUADRANT ASSIGNMENTS FOR PIN 1 ORIENTATION IN TAPE**

\*All dimensions are nominal

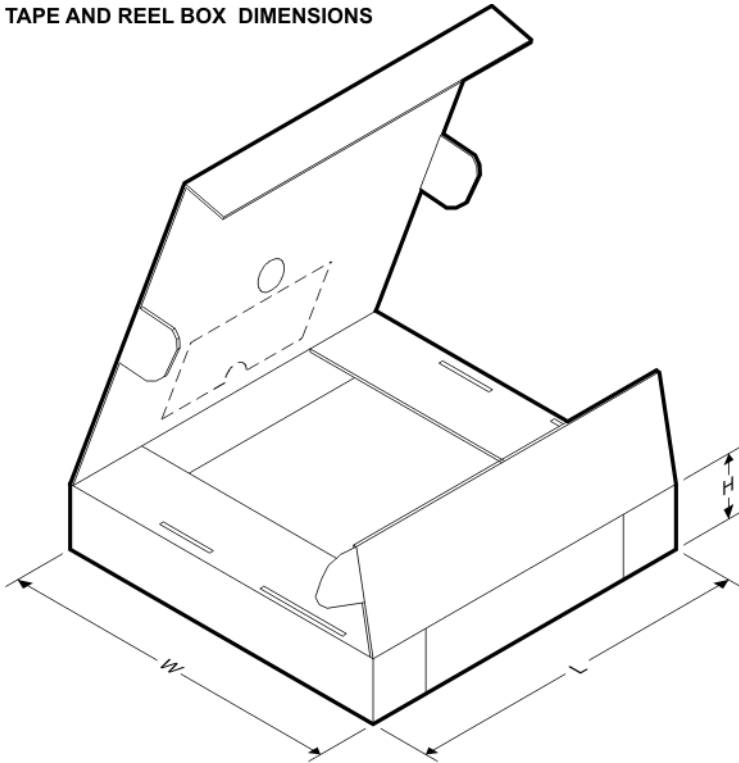
Device	Package Type	Package Drawing	Pins	SPQ	Reel Diameter (mm)	Reel Width W1 (mm)	A0 (mm)	B0 (mm)	K0 (mm)	P1 (mm)	W (mm)	Pin1 Quadrant
LM3490IM5-12	SOT-23	DBV	5	1000	178.0	8.4	3.2	3.2	1.4	4.0	8.0	Q3
LM3490IM5-12/NOPB	SOT-23	DBV	5	1000	178.0	8.4	3.2	3.2	1.4	4.0	8.0	Q3
LM3490IM5-3.3	SOT-23	DBV	5	1000	178.0	8.4	3.2	3.2	1.4	4.0	8.0	Q3
LM3490IM5-3.3/NOPB	SOT-23	DBV	5	1000	178.0	8.4	3.2	3.2	1.4	4.0	8.0	Q3
LM3490IM5-5.0/NOPB	SOT-23	DBV	5	1000	178.0	8.4	3.2	3.2	1.4	4.0	8.0	Q3
LM3490IM5X-12/NOPB	SOT-23	DBV	5	3000	178.0	8.4	3.2	3.2	1.4	4.0	8.0	Q3
LM3490IM5X-5.0/NOPB	SOT-23	DBV	5	3000	178.0	8.4	3.2	3.2	1.4	4.0	8.0	Q3

**TAPE AND REEL BOX DIMENSIONS**

\*All dimensions are nominal

Device	Package Type	Package Drawing	Pins	SPQ	Length (mm)	Width (mm)	Height (mm)
LM3490IM5-12	SOT-23	DBV	5	1000	210.0	185.0	35.0
LM3490IM5-12/NOPB	SOT-23	DBV	5	1000	210.0	185.0	35.0
LM3490IM5-3.3	SOT-23	DBV	5	1000	210.0	185.0	35.0
LM3490IM5-3.3/NOPB	SOT-23	DBV	5	1000	210.0	185.0	35.0
LM3490IM5-5.0/NOPB	SOT-23	DBV	5	1000	210.0	185.0	35.0
LM3490IM5X-12/NOPB	SOT-23	DBV	5	3000	210.0	185.0	35.0
LM3490IM5X-5.0/NOPB	SOT-23	DBV	5	3000	210.0	185.0	35.0

DBV (R-PDSO-G5)

PLASTIC SMALL-OUTLINE PACKAGE

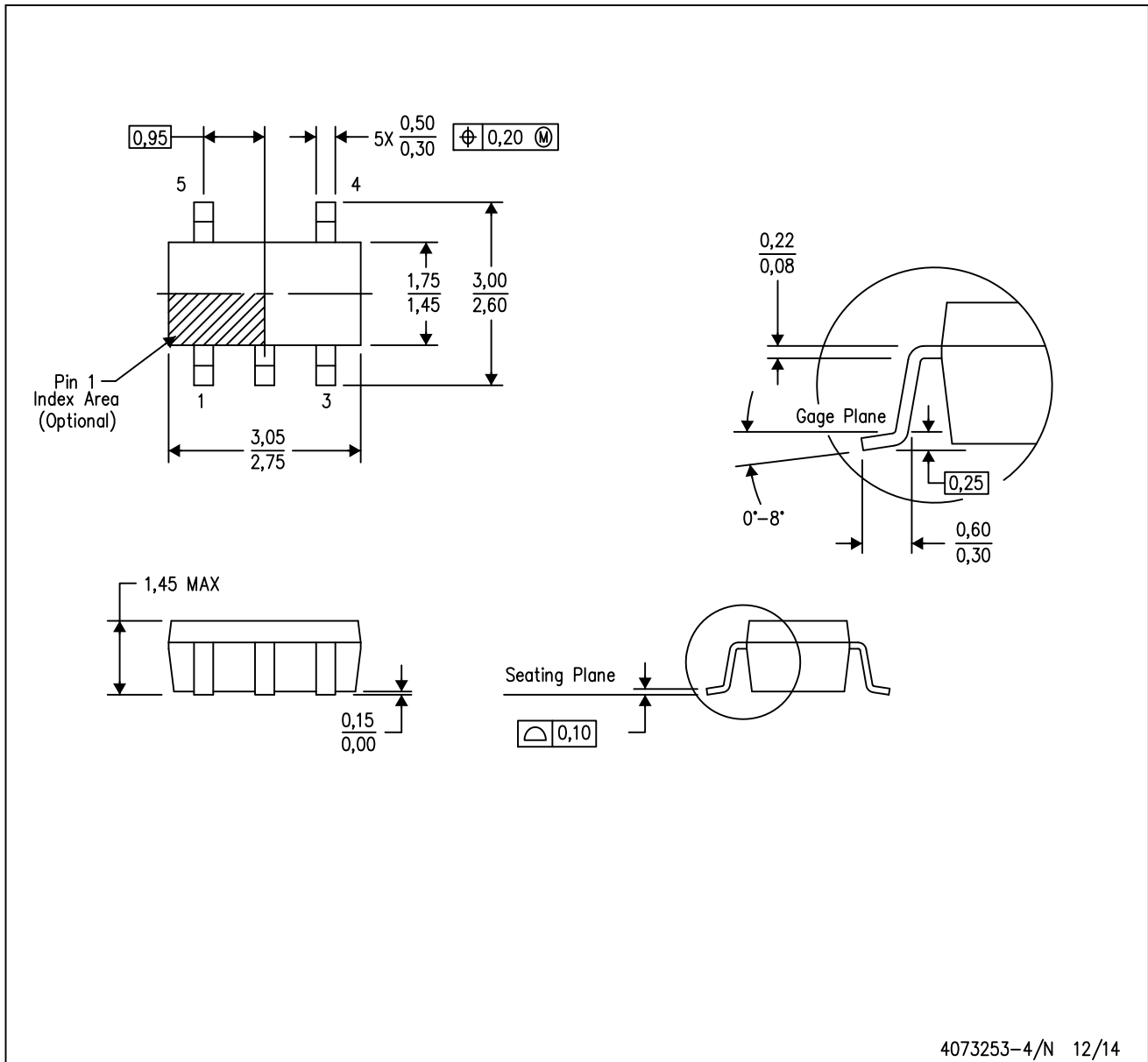

4073253-4/N 12/14

- NOTES:
- All linear dimensions are in millimeters.
  - This drawing is subject to change without notice.
  - Body dimensions do not include mold flash or protrusion. Mold flash and protrusion shall not exceed 0.15 per side.
  - Falls within JEDEC MO-178 Variation AA.

DBV (R-PDSO-G5)

PLASTIC SMALL OUTLINE

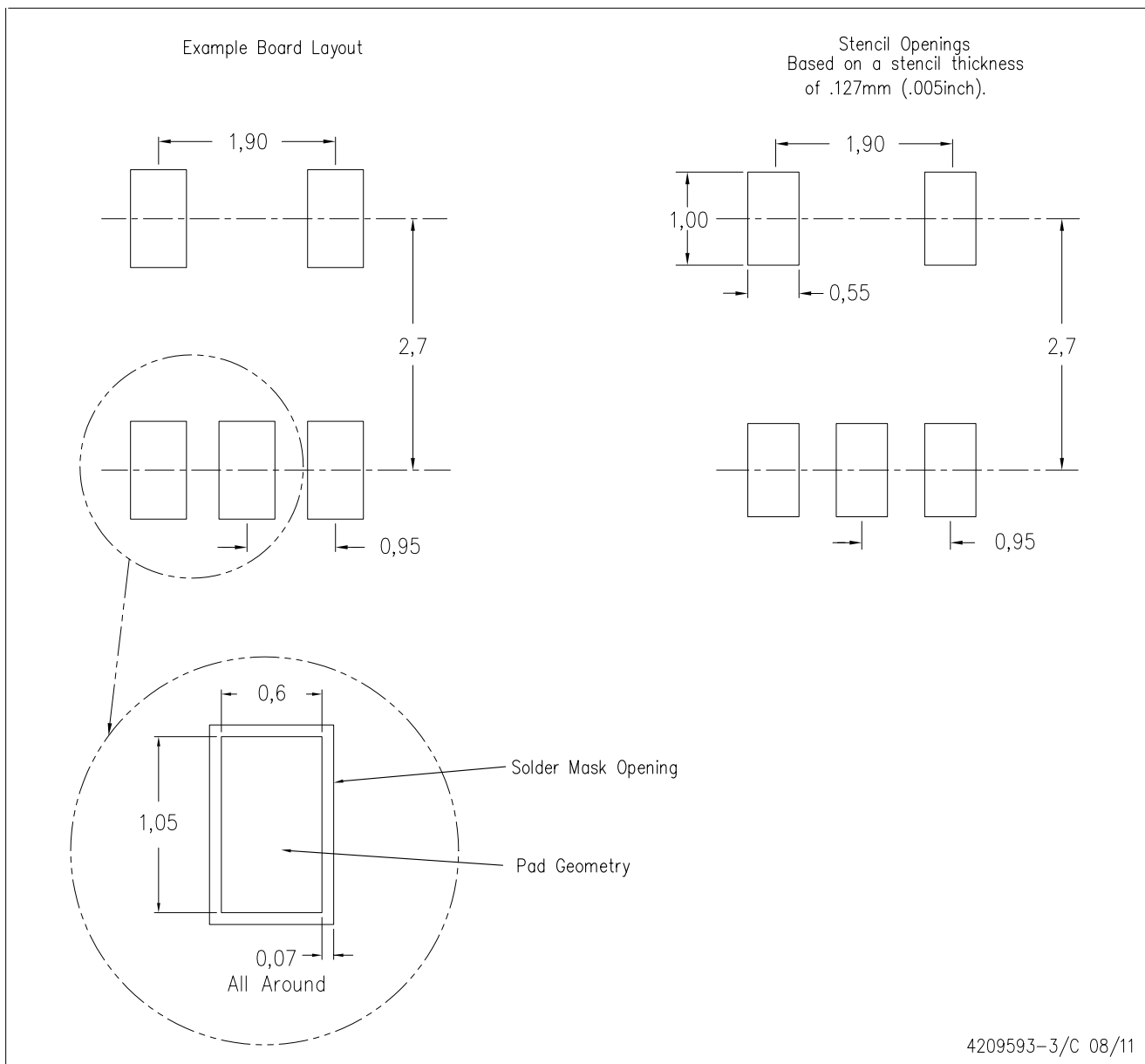

- NOTES:
- A. All linear dimensions are in millimeters.
  - B. This drawing is subject to change without notice.
  - C. Customers should place a note on the circuit board fabrication drawing not to alter the center solder mask defined pad.
  - D. Publication IPC-7351 is recommended for alternate designs.
  - E. Laser cutting apertures with trapezoidal walls and also rounding corners will offer better paste release. Customers should contact their board assembly site for stencil design recommendations. Example stencil design based on a 50% volumetric metal load solder paste. Refer to IPC-7525 for other stencil recommendations.

## IMPORTANT NOTICE

Texas Instruments Incorporated (TI) reserves the right to make corrections, enhancements, improvements and other changes to its semiconductor products and services per JESD46, latest issue, and to discontinue any product or service per JESD48, latest issue. Buyers should obtain the latest relevant information before placing orders and should verify that such information is current and complete.

TI's published terms of sale for semiconductor products (<http://www.ti.com/sc/docs/stdterms.htm>) apply to the sale of packaged integrated circuit products that TI has qualified and released to market. Additional terms may apply to the use or sale of other types of TI products and services.

Reproduction of significant portions of TI information in TI data sheets is permissible only if reproduction is without alteration and is accompanied by all associated warranties, conditions, limitations, and notices. TI is not responsible or liable for such reproduced documentation. Information of third parties may be subject to additional restrictions. Resale of TI products or services with statements different from or beyond the parameters stated by TI for that product or service voids all express and any implied warranties for the associated TI product or service and is an unfair and deceptive business practice. TI is not responsible or liable for any such statements.

Buyers and others who are developing systems that incorporate TI products (collectively, "Designers") understand and agree that Designers remain responsible for using their independent analysis, evaluation and judgment in designing their applications and that Designers have full and exclusive responsibility to assure the safety of Designers' applications and compliance of their applications (and of all TI products used in or for Designers' applications) with all applicable regulations, laws and other applicable requirements. Designer represents that, with respect to their applications, Designer has all the necessary expertise to create and implement safeguards that (1) anticipate dangerous consequences of failures, (2) monitor failures and their consequences, and (3) lessen the likelihood of failures that might cause harm and take appropriate actions. Designer agrees that prior to using or distributing any applications that include TI products, Designer will thoroughly test such applications and the functionality of such TI products as used in such applications.

TI's provision of technical, application or other design advice, quality characterization, reliability data or other services or information, including, but not limited to, reference designs and materials relating to evaluation modules, (collectively, "TI Resources") are intended to assist designers who are developing applications that incorporate TI products; by downloading, accessing or using TI Resources in any way, Designer (individually or, if Designer is acting on behalf of a company, Designer's company) agrees to use any particular TI Resource solely for this purpose and subject to the terms of this Notice.

TI's provision of TI Resources does not expand or otherwise alter TI's applicable published warranties or warranty disclaimers for TI products, and no additional obligations or liabilities arise from TI providing such TI Resources. TI reserves the right to make corrections, enhancements, improvements and other changes to its TI Resources. TI has not conducted any testing other than that specifically described in the published documentation for a particular TI Resource.

Designer is authorized to use, copy and modify any individual TI Resource only in connection with the development of applications that include the TI product(s) identified in such TI Resource. NO OTHER LICENSE, EXPRESS OR IMPLIED, BY ESTOPPEL OR OTHERWISE TO ANY OTHER TI INTELLECTUAL PROPERTY RIGHT, AND NO LICENSE TO ANY TECHNOLOGY OR INTELLECTUAL PROPERTY RIGHT OF TI OR ANY THIRD PARTY IS GRANTED HEREIN, including but not limited to any patent right, copyright, mask work right, or other intellectual property right relating to any combination, machine, or process in which TI products or services are used. Information regarding or referencing third-party products or services does not constitute a license to use such products or services, or a warranty or endorsement thereof. Use of TI Resources may require a license from a third party under the patents or other intellectual property of the third party, or a license from TI under the patents or other intellectual property of TI.

TI RESOURCES ARE PROVIDED "AS IS" AND WITH ALL FAULTS. TI DISCLAIMS ALL OTHER WARRANTIES OR REPRESENTATIONS, EXPRESS OR IMPLIED, REGARDING RESOURCES OR USE THEREOF, INCLUDING BUT NOT LIMITED TO ACCURACY OR COMPLETENESS, TITLE, ANY EPIDEMIC FAILURE WARRANTY AND ANY IMPLIED WARRANTIES OF MERCHANTABILITY, FITNESS FOR A PARTICULAR PURPOSE, AND NON-INFRINGEMENT OF ANY THIRD PARTY INTELLECTUAL PROPERTY RIGHTS. TI SHALL NOT BE LIABLE FOR AND SHALL NOT DEFEND OR INDEMNIFY DESIGNER AGAINST ANY CLAIM, INCLUDING BUT NOT LIMITED TO ANY INFRINGEMENT CLAIM THAT RELATES TO OR IS BASED ON ANY COMBINATION OF PRODUCTS EVEN IF DESCRIBED IN TI RESOURCES OR OTHERWISE. IN NO EVENT SHALL TI BE LIABLE FOR ANY ACTUAL, DIRECT, SPECIAL, COLLATERAL, INDIRECT, PUNITIVE, INCIDENTAL, CONSEQUENTIAL OR EXEMPLARY DAMAGES IN CONNECTION WITH OR ARISING OUT OF TI RESOURCES OR USE THEREOF, AND REGARDLESS OF WHETHER TI HAS BEEN ADVISED OF THE POSSIBILITY OF SUCH DAMAGES.

Unless TI has explicitly designated an individual product as meeting the requirements of a particular industry standard (e.g., ISO/TS 16949 and ISO 26262), TI is not responsible for any failure to meet such industry standard requirements.

Where TI specifically promotes products as facilitating functional safety or as compliant with industry functional safety standards, such products are intended to help enable customers to design and create their own applications that meet applicable functional safety standards and requirements. Using products in an application does not by itself establish any safety features in the application. Designers must ensure compliance with safety-related requirements and standards applicable to their applications. Designer may not use any TI products in life-critical medical equipment unless authorized officers of the parties have executed a special contract specifically governing such use. Life-critical medical equipment is medical equipment where failure of such equipment would cause serious bodily injury or death (e.g., life support, pacemakers, defibrillators, heart pumps, neurostimulators, and implantables). Such equipment includes, without limitation, all medical devices identified by the U.S. Food and Drug Administration as Class III devices and equivalent classifications outside the U.S.

TI may expressly designate certain products as completing a particular qualification (e.g., Q100, Military Grade, or Enhanced Product). Designers agree that it has the necessary expertise to select the product with the appropriate qualification designation for their applications and that proper product selection is at Designers' own risk. Designers are solely responsible for compliance with all legal and regulatory requirements in connection with such selection.

Designer will fully indemnify TI and its representatives against any damages, costs, losses, and/or liabilities arising out of Designer's non-compliance with the terms and provisions of this Notice.

## Looking for pricing, stock, or lifecycle information?

Click below to explore more details on WIN SOURCE:

 [View LM3490IM5X-3.3/NOPB on WIN SOURCE](#)

 [Texas Instruments](#) Information

## Optimize Your Supply Chain with WIN SOURCE Solutions

-  Global Sourcing Solution
-  Obsolete Management
-  Cost Control Management
-  Shortage Management
-  Alternative Solution
-  Excess Inventory Management