



THE DATASHEET OF DFE21CCN2R2MELL



CHIP COIL (CHIP INDUCTORS) for Consumer equipment & Industrial equipment DFE21CCN□□□□EL□ REFERENCE SPECIFICATION

1. Scope

This reference specification applies to DFE21CCN_EL series.

1.1 Specific applications:

- Power equipment: Products that can be used in power equipment such as renewable energy equipment, energy storage equipment and EV charging equipment and whose functions are not directly related to the protection of human life and property.
- Industrial equipment: Products that can be used in industrial equipment such as base stations, manufacturing equipment, industrial robotics equipment, and measurement equipment, and whose functions do not directly relate to the protection of human life and property.
- Medical equipment (GHTF Class C) *Except for implant/surgery/auto injector: Products that can be used for medical equipment of Class C of the international classification class GHTF and whose malfunction is considered to pose a relatively high risk to the human body.
- Medical equipment (GHTF Class A and B): Products that can be used for medical equipment regulated by Class A and Class B of the international classification class GHTF and whose functions do not directly relate to the protection of human life and property.
- Consumer equipment: Products that can be used in consumer equipment such as home appliances, audio/visual equipment, communication equipment, information equipment, office equipment, and household robotics, and whose functions are not directly related to the protection of human life and property.

1.2 Unsuitable application:

Applications listed in "Limitation of applications" in this reference specification.

2. Part Numbering

(ex)	DF	E	21	CC	N	R47	M	E	L	L
	Product ID	Type	Dimension (L×W)	Applications And Characteristics	Category	Inductance	Tolerance	Dimension (T)	Special specifications	Packaging

3. Part Number and Rating

- Operating temperature range (ambient temperature not including self-temperature rise) -40°C to +125°C
- Storage temperature range -40°C to +125°C
- Maximum voltage 20V

Customer Part Number	Murata Part Number	Inductance		DC Resistance (Ω)		*3 Rated Current(mA)			
						*1 Based on inductance change		*2 Based on Temperature rise	
		Nominal value (μH)	Tolerance (%)	Max.	Typ.	Max.	Typ.	Max.	Typ.
	DFE21CCNR24MELL	0.24	±20	0.020	0.016	6500	7900	5200	6100
	DFE21CCNR33MELL	0.33	±20	0.023	0.019	5400	6300	4600	5200
	DFE21CCNR47MELL	0.47	±20	0.029	0.025	4800	5400	4100	5000
	DFE21CCN1R0MELL	1.0	±20	0.060	0.054	3300	3700	2700	3200
	DFE21CCN2R2MELL	2.2	±20	0.138	0.120	2100	2500	1800	2100

*1 : The saturation allowable DC current value is specified when the decrease of the initial Inductance value at 30%.

*2 : The rated current (Based on the temperature rise) is the current value that reaches 40°C.

*3 : Keep the temperature (ambient temperature plus self-generation of heat) under 125°C.

The rated current is the rated current based on inductance change and the rated current based on temperature rise, whichever is smaller one.

4. Testing Conditions

< Unless otherwise specified >

Temperature : ordinary temperature (15°C to 35°C)
Humidity : ordinary humidity[25% to 85%(RH)]

< In case of doubt >

Temperature : 20°C ± 2°C
Humidity : 60% to 70%(RH)
Atmospheric pressure : 86kPa to 106kPa

5. Appearance and Dimensions

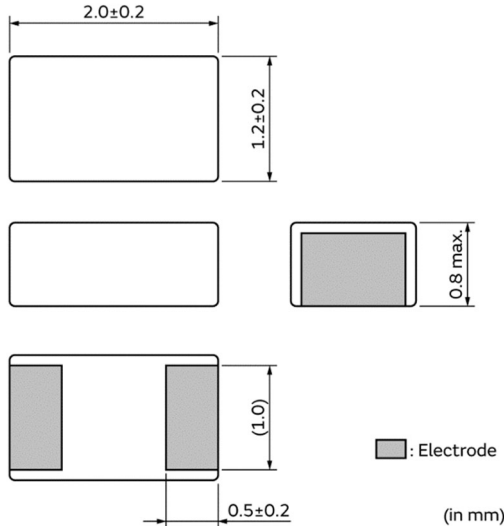

■ Unit mass (typical value): 0.013 g

6. Marking

No marking.

7. Electrical Performance

No.	Item	Specification	Test Method
7.1	Inductance	Inductance shall meet item 3.	Measuring Equipment : KEYSIGHT 4284A or equivalent Measurement signal level : 0.5V Measuring Frequency: 1MHz
7.2	DC Resistance	DC Resistance shall meet item 3.	Measuring Equipment : HIOKI 3541 or equivalent
7.3	Rated Current (Inductance change)	The saturation allowable DC current value is specified when the decrease of the initial Inductance value at 30%.	The rated current based on inductance change specified in Chapter 3 is applied.
7.4	Rated Current (temperature rise)	The temperature rise due to self-heating of the product is 40°C or less.	The rated current based on temperature rise specified in Chapter 3 is applied.
7.5	Maximum voltage	20V	The voltage is applied in the impulse test.

8. Mechanical Performance

The product is soldered on a substrate for test. (Except Resistance to soldering heat, Solderability)

It shall be soldered on the single Layer substrate (t=1.0mm). (Except Resistance to soldering heat, Solderability)

(Test shall be done using Flux, Solder and Soldering condition which are specified in chapter 12 except the case of being specified special condition.)

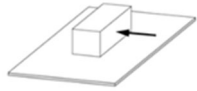
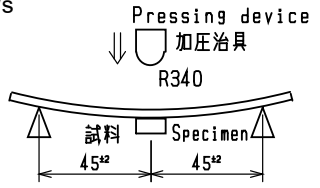
No.	Item	Specification	Test method
8.1	Shear test	No significant mechanical damage or no sign of electrode peeling off shall be observed.	Applying force:10N Holding time:5s Force application direction: 
8.2	Bending test	No significant mechanical damage or no sign of electrode peeling off shall be observed.	Test substrate: glass-epoxy substrate (100×40×1.0mm) Pressurizing speed:0.08mm/s Pressure jig:R340 Amount of bending:2mm Holding time:20s 
8.3	Vibration	No significant mechanical damage or no sign of electrode peeling off shall be observed.	Oscillation frequency:10 Hz to 55 Hz to 10 Hz/1min. Total amplitude: total amplitude of 1.5mm or acceleration amplitude of 98m/s ² whichever is smaller Test time:3 directions perpendicular to each other, 2 h for each direction (6 h in total)

No.	Item	Specification	Test method
8.4	Solderability	90% or more of the outer electrode shall be covered with new solder seamlessly.	Flux: Ethanol solution of rosin, 25(wt)% Solder : Sn-3.0Ag-0.5Cu Pre-Heating: 150±10°C / 60 to 90s Solder Temperature: 245±5°C Immersion Time: 3±0.5 s
8.5	Resistance to Soldering Heat	Appearance: No significant mechanical damage shall be observed. Inductance change rate: within ±10%	Flux: Ethanol solution of rosin, 25(wt)% Solder: Sn-3.0Ag-0.5Cu Pre-Heating: 150~180°C / 60 to 120s Solder Temperature: 230°C min / 30 to 90s Peak Temperature: 260+5/-0°C Reflow times: 2 times max Post-treatment: left for 1 to 2 hours at room temperature.

9. Environmental Performance

The product is soldered on a substrate for test.

It shall be soldered on the single Layer substrate (t=1.0mm).

(Test shall be done using Flux, Solder and Soldering condition which are specified in chapter 12 except the case of being specified special condition.)

No.	Item	Specification	Test Method
9.1	Heat resistance	Appearance: No significant mechanical damage shall be observed. Inductance change rate: ±10%	Temperature: +125±2°C Test time: 500 h (±12 h) Post-treatment: left for 1 hours over at ordinary temperature.
9.2	Cold resistance	Appearance: No significant mechanical damage shall be observed. Inductance change rate: ±10%	Temperature: -40±2°C Test time: 500 h (±12 h) Post-treatment: left for 1 hours over at ordinary temperature.
9.3	Humidity	Appearance: No significant mechanical damage shall be observed. Inductance change rate: ±10%	Temperature: +40±2°C Humidity : 90% to 95%(RH) Test time: 500 h (±12 h) Post-treatment: left for 1 hours over at ordinary temperature.
9.4	Temperature cycle	Appearance: No significant mechanical damage shall be observed. Inductance change rate: ±10%	Single cycle conditions: Step 1: -40±2°C / 30±3min Step 2: ordinary temperature, 3 min max. Step 3: +125±2°C / 30±3min Step 4: ordinary temperature, 3 min max. Number of testing: 100 cycles Post-treatment: left for 1 hours over at ordinary temperature.

10. Specification of Packaging

10.1 Appearance and dimensions of tape (8 mm width/plastic tape)

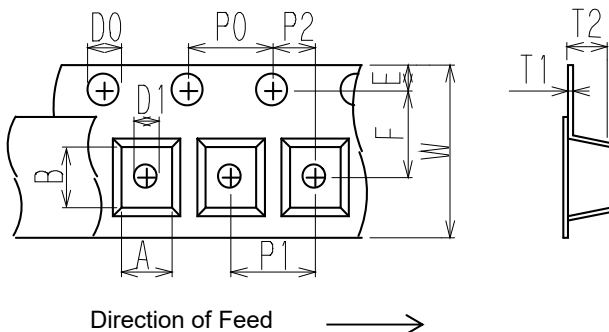

A	1.60±0.1	P0	4.0±0.1
B	2.33±0.1	P1	4.0±0.1
D0	φ1.5+0.1/-0	P2	2.0±0.05
D1	φ1.0+0.1/-0	T1	0.25±0.05
E	1.75±0.1	T2	0.9±0.1
F	3.5±0.05	W	8.0±0.2

(in mm)

10.2 Taping specifications

Packing quantity (Standard quantity)	3000pcs/reel
Packing method	The products are placed in cavities of a carrier tape and sealed by a cover tape.
Feed hole position	The feed holes on the carrier tape are on the right side when the cover tape is pulled toward the user.
Joint	The carrier tape and cover tape are seamless.
Number of missing products	Number of missing products within 0.1% of the number per reel or 1 pcs, whichever is greater, and are not continuous. The specified quantity per reel is kept.

10.3 Break down force of tape

cover tape	10 N min.
------------	-----------

10.4 Peeling off force of tape

Speed of peeling off	300mm/min
Peeling off force	0.1 to 1.0N (The lower limit is for typical value.)

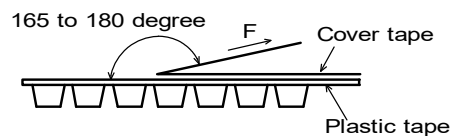

10.5 Dimensions of leader section, trailer section and reel

A vacant section is provided in the leader (start) section and trailer (end) section of the tape for the product. The leader section is further provided with an area consisting only of the cover tape. (See the diagram below.)

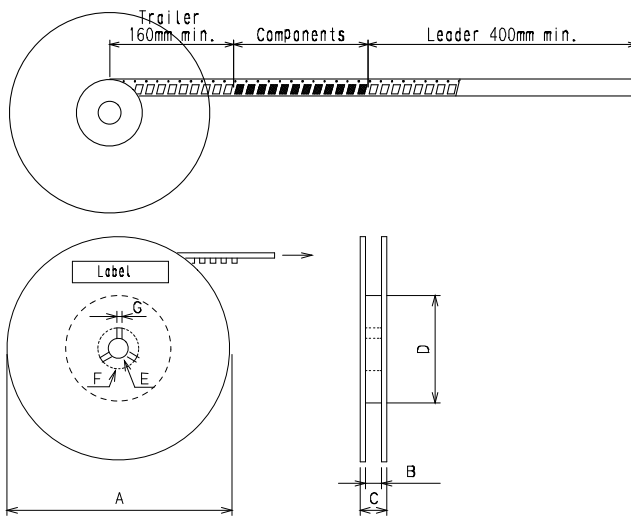

A	$\phi 180+0/-3$
B	9 ± 0.3
C	11.4 ± 1
D	$\phi 60\pm 1$
E	$\phi 13\pm 0.2$
F	$\phi 21\pm 0.8$
G	2.0 ± 0.5

(in mm)

10.6 Marking for reel

Customer part number, Murata part number, inspection number (*1), RoHS marking (*2), quantity, etc.

<p>*1 Expression of inspection No.:</p> <p style="text-align: center;"> $\square\square$ $\circ\circ\circ\circ$ $\diamond\diamond\diamond$ (1) (2) (3) </p>	<p>(1) Factory code</p> <p>(2) Date</p> <p style="padding-left: 20px;">First digit: year/last digit of year</p> <p style="padding-left: 20px;">Second digit: month/Jan. to Sep.→1 to 9, Oct. to Dec.→O, N, D</p> <p style="padding-left: 20px;">Third, Fourth digit: day</p> <p>(3) Serial No.</p>
<p>*2 Expression of RoHS marking:</p> <p style="text-align: center;"> ROHS- $\frac{Y}{(1)}$ $\frac{(\Delta)}{(2)}$ </p>	<p>(1) RoHS regulation conformity</p> <p>(2) Murata classification number</p>

10.7 Marking on outer box (corrugated box)

Customer name, purchasing order number, customer part number, Murata part number, RoHS marking (*2), quantity, etc

10.8 Specification of outer box

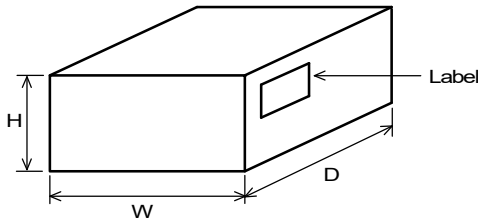

Dimensions of outer box (mm)			Standard reel quantity in outer box (reel)
W	D	H	
186	195	63	*5
*Above Outer Case size is typical. It depends on a quantity of an order.			

11. Caution

11.1 Limitation of applications

The products listed in the product specification (hereinafter the product(s) is called as the "Product(s)") are designed and manufactured for applications specified in the product specification (hereinafter called as the "Specific Application").

We shall not warrant anything in connection with the Products including fitness, performance, adequateness, safety, or quality, in the case of applications listed in from (1) to (11) written at the end of this precautions, which may generally require high performance, function, quality, management of production or safety. Therefore, the Product shall be applied in compliance with the specific application.

WE DISCLAIM ANY LOSS AND DAMAGES ARISING FROM OR IN CONNECTION WITH THE PRODUCTS INCLUDING BUT NOT LIMITED TO THE CASE SUCH LOSS AND DAMAGES CAUSED BY THE UNEXPECTED ACCIDENT, IN EVENT THAT (i) THE PRODUCT IS APPLIED FOR THE PURPOSE WHICH IS NOT SPECIFIED AS THE SPECIFIC APPLICATION FOR THE PRODUCT, AND/OR (ii) THE PRODUCT IS APPLIED FOR ANY FOLLOWING APPLICATION PURPOSES FROM (1) TO (11) (EXCEPT THAT SUCH APPLICATION PURPOSE IS UNAMBIGUOUSLY SPECIFIED AS SPECIFIC APPLICATION FOR THE PRODUCT IN OUR CATALOG SPECIFICATION FORMS, DATASHEETS, OR OTHER DOCUMENTS OFFICIALLY ISSUED BY US*).

- (1) Aircraft equipment
- (2) Aerospace equipment
- (3) Undersea equipment
- (4) Power plant control equipment
- (5) Medical equipment
- (6) Transportation equipment
- (7) Traffic control equipment
- (8) Disaster prevention/security equipment
- (9) Industrial data-processing equipment
- (10) Combustion/explosion control equipment
- (11) Equipment with complexity and/or required reliability equivalent to the applications listed in the above.

For exploring information of the Products which will be compatible with the particular purpose other than those specified in the product specification, please contact our sales offices, distribution agents, or trading companies with which you make a deal, or via our web contact form.

Contact form: <https://www.murata.com/contactform>

* We may design and manufacture particular Products for applications listed in (1) to (11). Provided that, in such case we shall unambiguously specify such Specific Application in the product specification without any exception. Therefore, any other documents and/or performances, whether exist or non-exist, shall not be deemed as the evidence to imply that we accept the applications listed in (1) to (11).

11.2 Precautions on rating

Avoid using in exceeded the rated temperature range, rated voltage, or rated current.

Usage when the ratings are exceeded could lead to wire breakage, burning, or other serious fault.

11.3 Inrush current

If an inrush current (or pulse current or rush current) that significantly exceeds the rated current is applied to the product, overheating could occur, resulting in wire breakage, burning, or other serious fault.

11.4 Corrosive gas

Please refrain from use since contact with environments with corrosive gases (sulfur gas [hydrogen sulfide, sulfur dioxide, etc.], chlorine, ammonia, etc.) or oils (cutting oil, silicone oil, etc.) that have come into contact with the previously stated corrosive gas environment will result in deterioration of product quality or an open from deterioration due to corrosion of product electrode, etc. We will not bear any responsibility for use under these environments.

12. Precautions for Use

This product is designed to be mounted by soldering. If you want to use other mounting method, for example, using a conductive adhesive, please consult us beforehand.

Also, if repeatedly subjected to temperature cycles or other thermal stress, due to the difference in the coefficient of thermal expansion with the mounting substrate, the solder (solder fillet part) in the mounting part may crack.

The occurrence of cracks due to thermal stress is affected by the size of the land where mounted, the solder volume, and the heat dissipation of the mounting substrate. Carefully design it when a large change in ambient temperature is assumed.

This product has a lower insulation resistance than conventional ferrite products, so care must be paid to its use.

- a) Do not make any through holes and copper pattern under the coil except a copper pattern to the electrode.
- b) Design/mount any components not to contact this product.

12.1 Land dimensions

The following diagram shows the recommended land dimensions for reflow soldering.

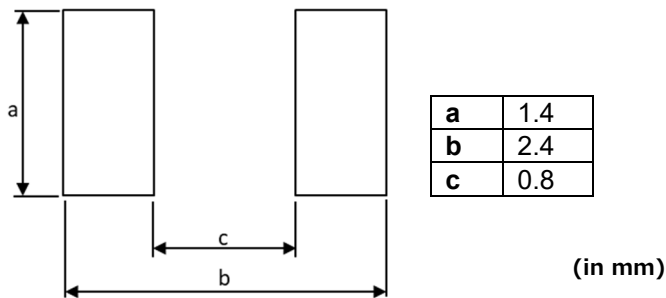

12.2 Flux and solder used

Flux	<ul style="list-style-type: none"> •Use a rosin-based flux. •Do not use a highly acidic flux with a halide content exceeding 0.2(wt)% (chlorine conversion value). •Do not use a water-soluble flux.
Solder	<ul style="list-style-type: none"> •Use Sn-3.0Ag-0.5Cu solder. •Standard thickness of solder paste: 100 μm to 150 μm

If you want to use a flux other than the above, please consult our technical department.

12.3 Soldering conditions (reflow)

- Pre-heating should be in such a way that the temperature difference between solder and product surface is limited to 100°C max.
Cooling into solvent after soldering also should be in such a way that the temperature difference is limited to 100°C max.
Insufficient pre-heating may cause cracks on the product, resulting in the deterioration of product quality.
- Standard soldering profile and the limit soldering profile is as follows.
The excessive limit soldering conditions may cause leaching of the electrode and/or resulting in the deterioration of product quality.

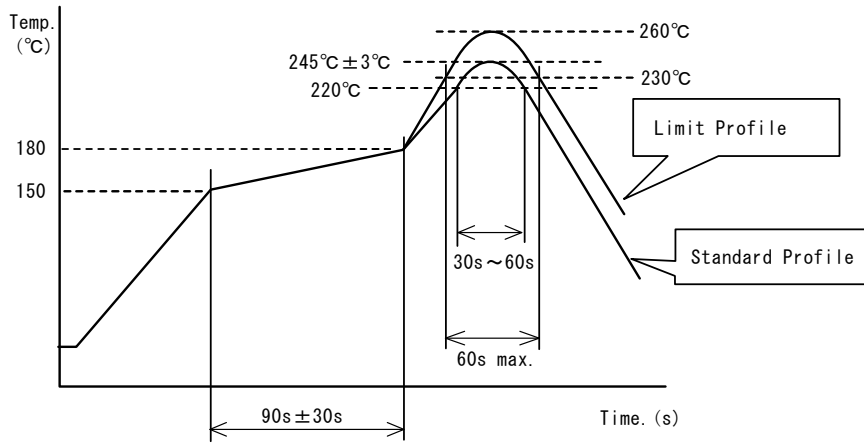

	Standard Profile	Limit Profile
Pre-heating	150°C to 180°C/90±30s	150°C to 180°C/90±30s
Heating	Above 220°C/30s to 60s	Above 230°C/60s max
Peak temperature	245°C±3°C	260°C/10s
Number of reflow cycles	2 times	2 times

12.4 Reworking with soldering iron

The following requirements must be met to rework a soldered product using a soldering iron.

Item	Requirement
Pre-heating	150°C/approx. 1 min
Tip temperature of soldering iron	350°C max.
Power consumption of soldering iron	60 W max.
Tip diameter of soldering iron	ø3 mm max.
Soldering time	3 s (+1 s, -0 s)
Number of reworking operations	1 time at each terminal
* Avoid a direct contact of the tip of the soldering iron with the product. Such a direction contact may cause cracks in the ceramic body due to thermal shock.	

12.5 Solder volume

Solder shall be used not to increase the volume too much.

An increased solder volume increases mechanical stress on the product. Exceeding solder volume may cause the failure of mechanical or electrical performance.

12.6 Product's location

The following shall be considered when designing and laying out P.C.B.'s.

- (1) P.C.B. shall be designed so that products are not subject to the mechanical stress due to warping the board.

[Products direction]

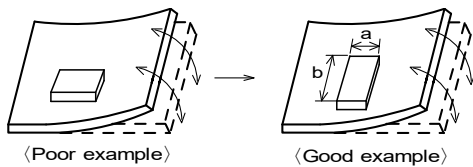

Products shall be located in the sideways direction to the mechanical stress.

(2) Components location on P.C.B. separation.

It is effective to implement the following measures, to reduce stress in separating the board.
 It is best to implement all of the following three measures; however, implement as many measures as possible to reduce stress.

Contents of Measures	Stress Level
(1) Turn the mounting direction of the component parallel to the board separation surface.	$A > D^{*1}$
(2) Add slits in the board separation part.	$A > B$
(3) Keep the mounting position of the component away from the board separation surface.	$A > C$
*1 $A > D$ is valid when stress is added vertically to the perforation as with hand separation. If a cutting disc is used, stress will be diagonal to the PCB, therefore $A > D$ is invalid.	

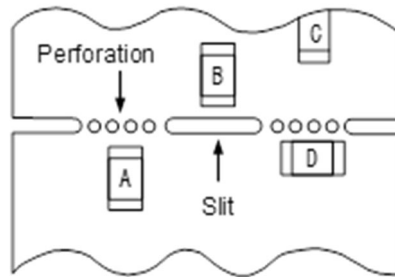

(3) Mounting components near screw holes

When a component is mounted near a screw hole, it may be affected by the board deflection that occurs during the tightening of the screw.

Mount the component in a position as far away from the screw holes as possible.

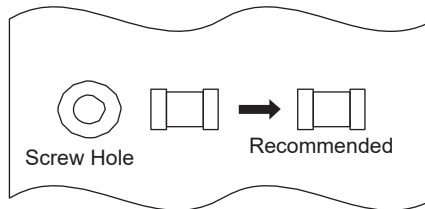

12.7 Handling of substrate

After mounting products on a substrate, do not apply any stress to the product caused by bending or twisting to the substrate when cropping the substrate, inserting and removing a connector from the substrate or tightening screw to the substrate.

Excessive mechanical stress may cause cracking in the product.

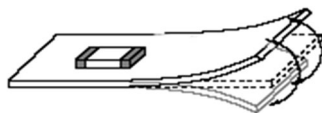

Bending

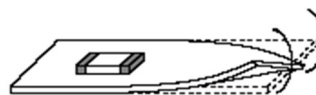

Twisting

12.8 Cleaning

During ultrasonic cleaning, depending on the cleaning conditions, the substrate may resonate and vibrate, causing chip cracks and cracked head. Be sure to check the quality of this product by cleaning with a cleaning device in advance.

12.9 Storage and transportation

Storage period	Use the product within 6 months after delivery. If you do not use the product for more than 12 months, check solderability before using it.
Storage conditions	<ul style="list-style-type: none"> • The products shall be stored in a room not subject to rapid changes in temperature and humidity. The recommended temperature range is -10°C to +40°C. The recommended relative humidity range is 15% to 85%. • Keeping the product in corrosive gases, such as sulfur, chlorine gas or acid may cause the poor solderability. • Do not place the products directly on the floor; they should be placed on a palette so that they are not affected by humidity or dust. • Avoid keeping the products in a place exposed to direct sunlight, heat or vibration. • Do not keep products in bulk packaging. Doing so may cause collision between the products or between the products and other products, resulting in chipping or wire breakage. • Avoid storing the product by itself bare (i.e. exposed directly to air).
Transportation	Excessive vibration and impact reduce the reliability of the products. Exercise caution when handling the products.

12.10 Resin coating (including moistureproof coating)

Coating/molding the product with resin may change electrical characteristics.

A wire breakage issue may occur by mechanical stress caused by the resin, amount/cured shape of resin, or operating condition etc. Some resin contains some impurities or chloride possible to generate chlorine by hydrolysis under some operating condition may cause corrosion of conductor, leading to wire breakage.

Prior to use the coating resin, please make sure no reliability issue is observed by evaluating products mounted on your board.

12.11 Mounting Conditions

- Please check the mounting condition before using.
- Using mounting conditions (nozzles, equipment conditions, etc.) that are not suitable for products may lead to pick up errors, misalignment, or damage to the product.

12.12 Operating Environment

Do not use under the following environmental conditions as it may lead to property deterioration or deterioration to open due to corrosion of product electrodes, etc.

Please note that we do not take any responsibility or liability for any damage or loss caused through in this environment.

- (1) in the corrodible atmosphere such as acidic gases, alkaline gases, chlorine, sulfur gases, organic gases and etc. (the sea breeze, Cl₂, H₂S, NH₃, SO₂, NO₂, etc)
- (2) When in contact with oil exposed under the corrosive gas environment (cutting oil, silicone oil, etc.)
- (3) in the atmosphere where liquid such as organic solvent, may splash on the products.
- (4) in the atmosphere where the temperature / humidity changes rapidly and it is easy to dew.

12.13 Implementation density

When placing this product near parts with heat generation, take sufficient heat radiation countermeasures.

If the heat received from other parts is large, the characteristics of this product may deteriorate, causing circuit operational failure or deterioration of the joints.

Be sure to use this product below the maximum rated operating temperature even when heat received from other parts is applied.

12.14 Handling of product

Inductance could change due to the effect of magnetism. Do not use magnetized tweezers, magnets, or other similar tools when handling the product (instead, use tweezers with resin or ceramic tips).

13.  Note

- (1) Please make sure that your product has been evaluated in view of your specifications with our product being mounted to your product.
 - (2) You are requested not to use our product deviating from the reference specifications.
 - (3) The contents of this reference specification are subject to change without advance notice.
- Please approve our product specifications or transact the approval sheet for product specifications before ordering.

Looking for pricing, stock, or lifecycle information?

Click below to explore more details on WIN SOURCE:

- ⊖ [View DFE21CCN2R2MELL on WIN SOURCE](#)
- ⊖ [Murata Electronics North America Information](#)

Optimize Your Supply Chain with WIN SOURCE Solutions

- ✓ Global Sourcing Solution
- ✓ Obsolete Management
- ✓ Cost Control Management
- ✓ Shortage Management
- ✓ Alternative Solution
- ✓ Excess Inventory Management