



**THE DATASHEET OF
LT3060IDC#TRPBF**



45V V_{IN} , Micropower, Low Noise, 100mA Low Dropout, Linear Regulator

FEATURES

- **Input Voltage Range: 1.6V to 45V**
- **Output Current: 100mA**
- **Quiescent Current: 40 μ A**
- **Dropout Voltage: 300mV**
- **Low Noise: 30 μ V_{RMS} (10Hz to 100kHz)**
- **Adjustable Output: $V_{REF} = 600mV$**
- Fixed Output Voltages: 1.2V, 1.5V, 1.8V, 2.5V, 3.3V, 5V, 15V
- Output Tolerance: $\pm 2\%$ Over Line, Load and Temperature
- Single Capacitor Soft-Starts Reference and Lowers Output Noise
- Shutdown Current: $< 1\mu A$
- Reverse Battery Protection
- Current Limit Foldback Protection
- Thermal Limit Protection
- 8-Lead 2mm \times 2mm \times 0.75mm DFN and 8-Lead ThinSOT™ Packages
- AEC-Q100 Qualified for Automotive Applications

APPLICATIONS

- Battery-Powered Systems
- Automotive Power Supplies
- Industrial Power Supplies
- Avionic Power Supplies
- Portable Instruments

DESCRIPTION

The **LT[®]3060** series are micropower, low dropout voltage (LDO) linear regulators that operate over a 1.6V to 45V input supply range. The devices supply 100mA of output current with a typical dropout voltage of 300mV. A single external capacitor provides programmable low noise reference performance and output soft-start functionality. The LT3060's quiescent current is merely 40 μ A and provides fast transient response with a minimum 2.2 μ F output capacitor. In shutdown, quiescent current is less than 1 μ A and the reference soft-start capacitor is reset.

The LT3060 regulators optimize stability and transient response with low ESR, ceramic output capacitors. The regulators do not require the addition of ESR as is common with other regulators.

Internal protection circuitry includes reverse-battery protection, reverse-output protection, reverse-current protection, current limit with foldback and thermal shutdown. The LT3060 series are available in fixed output voltages of 1.2V, 1.5V, 1.8V, 2.5V, 3.3V, 5V and 15V, and as an adjustable voltage regulator with an output voltage range from the 600mV reference to 44.5V. The LT3060 regulators are offered in the thermally enhanced 8-lead TSOT-23 and 8-lead (2mm \times 2mm \times 0.75mm) DFN packages.

All registered trademarks and trademarks are the property of their respective owners.

TYPICAL APPLICATION

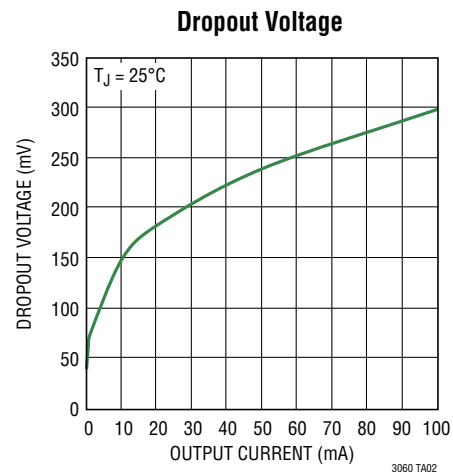
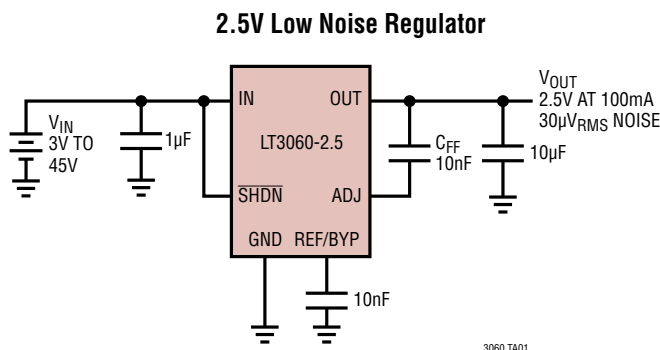

LT3060 Series

ABSOLUTE MAXIMUM RATINGS (Note 1)

IN Pin Voltage	±50V	Output Short-Circuit Duration	Indefinite
OUT Pin Voltage	±50V	Operating Junction Temperature (Notes 3, 5, 13)	
Input-to-Output Differential Voltage (Note 2)	±50V	E-, I-Grades	–40°C to 125°C
ADJ Pin Voltage	±50V	MP-Grade	–55°C to 150°C
SHDN Pin Voltage	±50V	H-Grade	–40°C to 150°C
REF/BYP Pin Voltage	–0.3V, 1V	Storage Temperature Range	–65°C to 150°C
		Lead Temperature (TS8 Soldering, 10 sec)	300°C

PIN CONFIGURATION

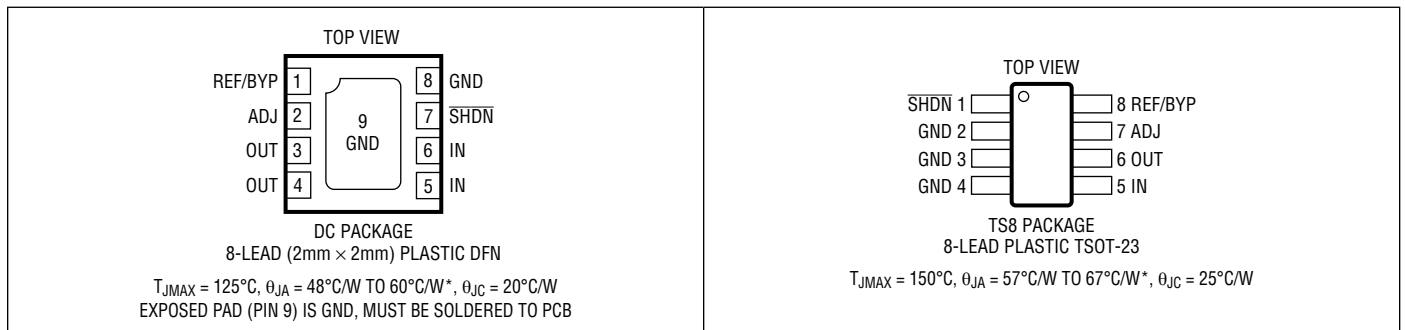

* SEE APPLICATIONS INFORMATION SECTION

ORDER INFORMATION

TAPE AND REEL (MINI)	TAPE AND REEL	PART MARKING*	PACKAGE DESCRIPTION	TEMPERATURE RANGE
LT3060EDC#TRMPBF	LT3060EDC#TRPBF	LDTD	8-Lead (2mm × 2mm) Plastic DFN	–40°C to 125°C
LT3060IDC#TRMPBF	LT3060IDC#TRPBF	LDTD	8-Lead (2mm × 2mm) Plastic DFN	–40°C to 125°C
LT3060EDC-1.2#TRMPBF	LT3060EDC-1.2#TRPBF	LFVT	8-Lead (2mm × 2mm) Plastic DFN	–40°C to 125°C
LT3060IDC-1.2#TRMPBF	LT3060IDC-1.2#TRPBF	LFVT	8-Lead (2mm × 2mm) Plastic DFN	–40°C to 125°C
LT3060EDC-1.5#TRMPBF	LT3060EDC-1.5#TRPBF	LFVV	8-Lead (2mm × 2mm) Plastic DFN	–40°C to 125°C
LT3060IDC-1.5#TRMPBF	LT3060IDC-1.5#TRPBF	LFVV	8-Lead (2mm × 2mm) Plastic DFN	–40°C to 125°C
LT3060EDC-1.8#TRMPBF	LT3060EDC-1.8#TRPBF	LFVW	8-Lead (2mm × 2mm) Plastic DFN	–40°C to 125°C
LT3060IDC-1.8#TRMPBF	LT3060IDC-1.8#TRPBF	LFVW	8-Lead (2mm × 2mm) Plastic DFN	–40°C to 125°C
LT3060EDC-2.5#TRMPBF	LT3060EDC-2.5#TRPBF	LFVX	8-Lead (2mm × 2mm) Plastic DFN	–40°C to 125°C
LT3060IDC-2.5#TRMPBF	LT3060IDC-2.5#TRPBF	LFVX	8-Lead (2mm × 2mm) Plastic DFN	–40°C to 125°C
LT3060EDC-3.3#TRMPBF	LT3060EDC-3.3#TRPBF	LFVY	8-Lead (2mm × 2mm) Plastic DFN	–40°C to 125°C
LT3060IDC-3.3#TRMPBF	LT3060IDC-3.3#TRPBF	LFVY	8-Lead (2mm × 2mm) Plastic DFN	–40°C to 125°C
LT3060EDC-5#TRMPBF	LT3060EDC-5#TRPBF	LFVZ	8-Lead (2mm × 2mm) Plastic DFN	–40°C to 125°C
LT3060IDC-5#TRMPBF	LT3060IDC-5#TRPBF	LFVZ	8-Lead (2mm × 2mm) Plastic DFN	–40°C to 125°C
LT3060EDC-15#TRMPBF	LT3060EDC-15#TRPBF	LGSK	8-Lead (2mm × 2mm) Plastic DFN	–40°C to 125°C
LT3060IDC-15#TRMPBF	LT3060IDC-15#TRPBF	LGSK	8-Lead (2mm × 2mm) Plastic DFN	–40°C to 125°C
LT3060ETS8#TRMPBF	LT3060ETS8#TRPBF	LTDTF	8-Lead Plastic ThinSOT	–40°C to 125°C
LT3060ITS8#TRMPBF	LT3060ITS8#TRPBF	LTDTF	8-Lead Plastic ThinSOT	–40°C to 125°C

Rev. D

ORDER INFORMATION

TAPE AND REEL (MINI)	TAPE AND REEL	PART MARKING*	PACKAGE DESCRIPTION	TEMPERATURE RANGE
LT3060MPTS8#TRMPBF	LT3060MPTS8#TRPBF	LTDTF	8-Lead Plastic ThinSOT	-55°C to 150°C
LT3060HTS8#TRMPBF	LT3060HTS8#TRPBF	LTDTF	8-Lead Plastic ThinSOT	-40°C to 150°C
LT3060ETS8-1.2#TRMPBF	LT3060ETS8-1.2#TRPBF	LTFWB	8-Lead Plastic ThinSOT	-40°C to 125°C
LT3060ITS8-1.2#TRMPBF	LT3060ITS8-1.2#TRPBF	LTFWB	8-Lead Plastic ThinSOT	-40°C to 125°C
LT3060MPTS8-1.2#TRMPBF	LT3060MPTS8-1.2#TRPBF	LTFWB	8-Lead Plastic ThinSOT	-55°C to 150°C
LT3060HTS8-1.2#TRMPBF	LT3060HTS8-1.2#TRPBF	LTFWB	8-Lead Plastic ThinSOT	-40°C to 150°C
LT3060ETS8-1.5#TRMPBF	LT3060ETS8-1.5#TRPBF	LTFWC	8-Lead Plastic ThinSOT	-40°C to 125°C
LT3060ITS8-1.5#TRMPBF	LT3060ITS8-1.5#TRPBF	LTFWC	8-Lead Plastic ThinSOT	-40°C to 125°C
LT3060MPTS8-1.5#TRMPBF	LT3060MPTS8-1.5#TRPBF	LTFWC	8-Lead Plastic ThinSOT	-55°C to 150°C
LT3060HTS8-1.5#TRMPBF	LT3060HTS8-1.5#TRPBF	LTFWC	8-Lead Plastic ThinSOT	-40°C to 150°C
LT3060ETS8-1.8#TRMPBF	LT3060ETS8-1.8#TRPBF	LTFWD	8-Lead Plastic ThinSOT	-40°C to 125°C
LT3060ITS8-1.8#TRMPBF	LT3060ITS8-1.8#TRPBF	LTFWD	8-Lead Plastic ThinSOT	-40°C to 125°C
LT3060MPTS8-1.8#TRMPBF	LT3060MPTS8-1.8#TRPBF	LTFWD	8-Lead Plastic ThinSOT	-55°C to 150°C
LT3060HTS8-1.8#TRMPBF	LT3060HTS8-1.8#TRPBF	LTFWD	8-Lead Plastic ThinSOT	-40°C to 150°C
LT3060ETS8-2.5#TRMPBF	LT3060ETS8-2.5#TRPBF	LTFWF	8-Lead Plastic ThinSOT	-40°C to 125°C
LT3060ITS8-2.5#TRMPBF	LT3060ITS8-2.5#TRPBF	LTFWF	8-Lead Plastic ThinSOT	-40°C to 125°C
LT3060MPTS8-2.5#TRMPBF	LT3060MPTS8-2.5#TRPBF	LTFWF	8-Lead Plastic ThinSOT	-55°C to 150°C
LT3060HTS8-2.5#TRMPBF	LT3060HTS8-2.5#TRPBF	LTFWF	8-Lead Plastic ThinSOT	-40°C to 150°C
LT3060ETS8-3.3#TRMPBF	LT3060ETS8-3.3#TRPBF	LTFWG	8-Lead Plastic ThinSOT	-40°C to 125°C
LT3060ITS8-3.3#TRMPBF	LT3060ITS8-3.3#TRPBF	LTFWG	8-Lead Plastic ThinSOT	-40°C to 125°C
LT3060MPTS8-3.3#TRMPBF	LT3060MPTS8-3.3#TRPBF	LTFWG	8-Lead Plastic ThinSOT	-55°C to 150°C
LT3060HTS8-3.3#TRMPBF	LT3060HTS8-3.3#TRPBF	LTFWG	8-Lead Plastic ThinSOT	-40°C to 150°C
LT3060ETS8-5#TRMPBF	LT3060ETS8-5#TRPBF	LTFWH	8-Lead Plastic ThinSOT	-40°C to 125°C
LT3060ITS8-5#TRMPBF	LT3060ITS8-5#TRPBF	LTFWH	8-Lead Plastic ThinSOT	-40°C to 125°C
LT3060MPTS8-5#TRMPBF	LT3060MPTS8-5#TRPBF	LTFWH	8-Lead Plastic ThinSOT	-55°C to 150°C
LT3060HTS8-5#TRMPBF	LT3060HTS8-5#TRPBF	LTFWH	8-Lead Plastic ThinSOT	-40°C to 150°C
LT3060ETS8-15#TRMPBF	LT3060ETS8-15#TRPBF	LTGSM	8-Lead Plastic ThinSOT	-40°C to 125°C
LT3060ITS8-15#TRMPBF	LT3060ITS8-15#TRPBF	LTGSM	8-Lead Plastic ThinSOT	-40°C to 125°C
LT3060MPTS8-15#TRMPBF	LT3060MPTS8-15#TRPBF	LTGSM	8-Lead Plastic ThinSOT	-55°C to 150°C
LT3060HTS8-15#TRMPBF	LT3060HTS8-15#TRPBF	LTGSM	8-Lead Plastic ThinSOT	-40°C to 150°C
AUTOMOTIVE PRODUCTS**				
LT3060EDC#WTRMPBF	LT3060EDC#WTRPBF	LDTD	8-Lead (2mm × 2mm) Plastic DFN	-40°C to 125°C
LT3060IDC#WTRMPBF	LT3060IDC#WTRPBF	LDTD	8-Lead (2mm × 2mm) Plastic DFN	-40°C to 125°C
LT3060EDC-5#WTRMPBF	LT3060EDC-5#WTRPBF	LFVZ	8-Lead (2mm × 2mm) Plastic DFN	-40°C to 125°C
LT3060IDC-5#WTRMPBF	LT3060IDC-5#WTRPBF	LFVZ	8-Lead (2mm × 2mm) Plastic DFN	-40°C to 125°C

Contact the factory for parts specified with wider operating temperature ranges. *The temperature grade is identified by a label on the shipping container.

Tape and reel specifications. Some packages are available in 500 unit reels through designated sales channels with #TRMPBF suffix.

**Versions of this part are available with controlled manufacturing to support the quality and reliability requirements of automotive applications. These models are designated with a #W suffix. Only the automotive grade products shown are available for use in automotive applications. Contact your local Analog Devices account representative for specific product ordering information and to obtain the specific Automotive Reliability reports for these models.

LT3060 Series

ELECTRICAL CHARACTERISTICS

The ● denotes the specifications which apply over the full operating temperature range, otherwise specifications are at $T_A = 25^\circ\text{C}$. (Note 3)

PARAMETER	CONDITIONS		MIN	TYP	MAX	UNITS
Minimum Input Voltage (Notes 4, 12)	$I_{LOAD} = 100\text{mA}$	●		1.6	2.1	V
Regulated Output Voltage (Note 5)	LT3060-1.2: $V_{IN} = 2.1\text{V}$, $I_{LOAD} = 1\text{mA}$		1.188	1.2	1.212	V
	$2.1\text{V} < V_{IN} < 45\text{V}$, $1\text{mA} < I_{LOAD} < 100\text{mA}$ (E-, I-Grades)	●	1.176	1.2	1.224	V
	$2.1\text{V} < V_{IN} < 45\text{V}$, $1\text{mA} < I_{LOAD} < 100\text{mA}$ (MP-, H-Grades)	●	1.170	1.2	1.224	V
	LT3060-1.5: $V_{IN} = 2.1\text{V}$, $I_{LOAD} = 1\text{mA}$		1.485	1.5	1.515	V
	$2.1\text{V} < V_{IN} < 45\text{V}$, $1\text{mA} < I_{LOAD} < 100\text{mA}$ (E-, I-Grades)	●	1.470	1.5	1.530	V
	$2.1\text{V} < V_{IN} < 45\text{V}$, $1\text{mA} < I_{LOAD} < 100\text{mA}$ (MP-, H-Grades)	●	1.463	1.5	1.530	V
	LT3060-1.8: $V_{IN} = 2.35\text{V}$, $I_{LOAD} = 1\text{mA}$		1.782	1.8	1.818	V
	$2.35\text{V} < V_{IN} < 45\text{V}$, $1\text{mA} < I_{LOAD} < 100\text{mA}$ (E-, I-Grades)	●	1.764	1.8	1.836	V
	$2.35\text{V} < V_{IN} < 45\text{V}$, $1\text{mA} < I_{LOAD} < 100\text{mA}$ (MP-, H-Grades)	●	1.755	1.8	1.836	V
	LT3060-2.5: $V_{IN} = 3.05\text{V}$, $I_{LOAD} = 1\text{mA}$		2.475	2.5	2.525	V
	$3.05\text{V} < V_{IN} < 45\text{V}$, $1\text{mA} < I_{LOAD} < 100\text{mA}$ (E-, I-Grades)	●	2.450	2.5	2.550	V
	$3.05\text{V} < V_{IN} < 45\text{V}$, $1\text{mA} < I_{LOAD} < 100\text{mA}$ (MP-, H-Grades)	●	2.438	2.5	2.550	V
LT3060-3.3: $V_{IN} = 3.85\text{V}$, $I_{LOAD} = 1\text{mA}$			3.267	3.3	3.333	V
	$3.85\text{V} < V_{IN} < 45\text{V}$, $1\text{mA} < I_{LOAD} < 100\text{mA}$ (E-, I-Grades)	●	3.234	3.3	3.366	V
	$3.85\text{V} < V_{IN} < 45\text{V}$, $1\text{mA} < I_{LOAD} < 100\text{mA}$ (MP-, H-Grades)	●	3.218	3.3	3.366	V
LT3060-5: $V_{IN} = 5.55\text{V}$, $I_{LOAD} = 1\text{mA}$			4.950	5	5.050	V
	$5.55\text{V} < V_{IN} < 45\text{V}$, $1\text{mA} < I_{LOAD} < 100\text{mA}$ (E-, I-Grades)	●	4.900	5	5.100	V
	$5.55\text{V} < V_{IN} < 45\text{V}$, $1\text{mA} < I_{LOAD} < 100\text{mA}$ (MP-, H-Grades)	●	4.875	5	5.100	V
LT3060-15: $V_{IN} = 15.55\text{V}$, $I_{LOAD} = 1\text{mA}$			14.85	15	15.15	V
	$15.55\text{V} < V_{IN} < 45\text{V}$, $1\text{mA} < I_{LOAD} < 100\text{mA}$ (E-, I-Grades)	●	14.70	15	15.30	V
	$15.55\text{V} < V_{IN} < 45\text{V}$, $1\text{mA} < I_{LOAD} < 100\text{mA}$ (MP-, H-Grades)	●	14.63	15	15.30	V
ADJ Pin Voltage (Notes 4, 5)	LT3060: $V_{IN} = 2.1\text{V}$, $I_{LOAD} = 1\text{mA}$		594	600	606	mV
	$2.1\text{V} < V_{IN} < 45\text{V}$, $1\text{mA} < I_{LOAD} < 100\text{mA}$ (E-, I-Grades)	●	588	600	612	mV
	$2.1\text{V} < V_{IN} < 45\text{V}$, $1\text{mA} < I_{LOAD} < 100\text{mA}$ (MP-, H-Grades)	●	585	600	612	mV
Line Regulation	LT3060-1.2: $\Delta V_{IN} = 2.1\text{V}$ to 45V , $I_{LOAD} = 1\text{mA}$	(E-, I-Grades)	●	0.9	3.5	mV
	$\Delta V_{IN} = 2.1\text{V}$ to 45V , $I_{LOAD} = 1\text{mA}$	(MP-, H-Grades)	●		7	
	LT3060-1.5: $\Delta V_{IN} = 2.1\text{V}$ to 45V , $I_{LOAD} = 1\text{mA}$	(E-, I-Grades)	●	1	4.2	mV
	$\Delta V_{IN} = 2.1\text{V}$ to 45V , $I_{LOAD} = 1\text{mA}$	(MP-, H-Grades)	●		8	
	LT3060-1.8: $\Delta V_{IN} = 2.35\text{V}$ to 45V , $I_{LOAD} = 1\text{mA}$	(E-, I-Grades)	●	1.1	4.5	mV
	$\Delta V_{IN} = 2.35\text{V}$ to 45V , $I_{LOAD} = 1\text{mA}$	(MP-, H-Grades)	●		12	
	LT3060-2.5: $\Delta V_{IN} = 3.05\text{V}$ to 45V , $I_{LOAD} = 1\text{mA}$	(E-, I-Grades)	●	1.2	5.4	mV
	$\Delta V_{IN} = 3.05\text{V}$ to 45V , $I_{LOAD} = 1\text{mA}$	(MP-, H-Grades)	●		15	
	LT3060-3.3: $\Delta V_{IN} = 3.85\text{V}$ to 45V , $I_{LOAD} = 1\text{mA}$	(E-, I-Grades)	●	1.3	7	mV
	$\Delta V_{IN} = 3.85\text{V}$ to 45V , $I_{LOAD} = 1\text{mA}$	(MP-, H-Grades)	●		19	
LT3060-5: $\Delta V_{IN} = 5.55\text{V}$ to 45V , $I_{LOAD} = 1\text{mA}$	(E-, I-Grades)	●	1.5	8.5	mV	
$\Delta V_{IN} = 5.55\text{V}$ to 45V , $I_{LOAD} = 1\text{mA}$	(MP-, H-Grades)	●		25		
LT3060-15: $\Delta V_{IN} = 15.55\text{V}$ to 45V , $I_{LOAD} = 1\text{mA}$	(E-, I-Grades)	●	2.2	22	mV	
$\Delta V_{IN} = 15.55\text{V}$ to 45V , $I_{LOAD} = 1\text{mA}$	(MP-, H-Grades)	●		55		
LT3060: (Note 4)	$\Delta V_{IN} = 2.1\text{V}$ to 45V , $I_{LOAD} = 1\text{mA}$	(E-, I-Grades)	●	0.6	3.5	mV
	$\Delta V_{IN} = 2.1\text{V}$ to 45V , $I_{LOAD} = 1\text{mA}$	(MP-, H-Grades)	●		4	

ELECTRICAL CHARACTERISTICS

The ● denotes the specifications which apply over the full operating temperature range, otherwise specifications are at $T_A = 25^\circ\text{C}$. (Note 3)

PARAMETER	CONDITIONS		MIN	TYP	MAX	UNITS
Load Regulation (Note 15)	LT3060-1.2: $V_{IN} = 2.1\text{V}$, $I_{LOAD} = 1\text{mA}$ to 100mA $V_{IN} = 2.1\text{V}$, $I_{LOAD} = 1\text{mA}$ to 100mA	(E-, I-Grades) (MP-, H-Grades)	● ●	2.4	10	mV 18
	LT3060-1.5: $V_{IN} = 2.1\text{V}$, $I_{LOAD} = 1\text{mA}$ to 100mA $V_{IN} = 2.1\text{V}$, $I_{LOAD} = 1\text{mA}$ to 100mA	(E-, I-Grades) (MP-, H-Grades)	● ●	2.5	12	mV 22
	LT3060-1.8: $V_{IN} = 2.35\text{V}$, $I_{LOAD} = 1\text{mA}$ to 100mA $V_{IN} = 2.35\text{V}$, $I_{LOAD} = 1\text{mA}$ to 100mA	(E-, I-Grades) (MP-, H-Grades)	● ●	2.6	14	mV 27
	LT3060-2.5: $V_{IN} = 3.05\text{V}$, $I_{LOAD} = 1\text{mA}$ to 100mA $V_{IN} = 3.05\text{V}$, $I_{LOAD} = 1\text{mA}$ to 100mA	(E-, I-Grades) (MP-, H-Grades)	● ●	2.8	19	mV 37
	LT3060-3.3: $V_{IN} = 3.85\text{V}$, $I_{LOAD} = 1\text{mA}$ to 100mA $V_{IN} = 3.85\text{V}$, $I_{LOAD} = 1\text{mA}$ to 100mA	(E-, I-Grades) (MP-, H-Grades)	● ●	3.1	24	mV 49
	LT3060-5: $V_{IN} = 5.55\text{V}$, $I_{LOAD} = 1\text{mA}$ to 100mA $V_{IN} = 5.55\text{V}$, $I_{LOAD} = 1\text{mA}$ to 100mA	(E-, I-Grades) (MP-, H-Grades)	● ●	3.7	35	mV 75
	LT3060-15: $V_{IN} = 15.55\text{V}$, $I_{LOAD} = 1\text{mA}$ to 100mA $V_{IN} = 15.55\text{V}$, $I_{LOAD} = 1\text{mA}$ to 100mA	(E-, I-Grades) (MP-, H-Grades)	● ●	7	100	mV 225
	LT3060: (Note 4)	$V_{IN} = 2.1\text{V}$, $I_{LOAD} = 1\text{mA}$ to 100mA $V_{IN} = 2.1\text{V}$, $I_{LOAD} = 1\text{mA}$ to 100mA	(E-, I-Grades) (MP-, H-Grades)	● ●	0.2	4
Dropout Voltage $V_{IN} = V_{OUT(NOMINAL)}$ (Notes 6, 7)	$I_{LOAD} = 1\text{mA}$ $I_{LOAD} = 1\text{mA}$		●	75	110	mV 180
	$I_{LOAD} = 10\text{mA}$ $I_{LOAD} = 10\text{mA}$		●	150	200	mV 300
	$I_{LOAD} = 50\text{mA}$ (Note 14) $I_{LOAD} = 50\text{mA}$ (Note 14)		●	240	280	mV 410
	$I_{LOAD} = 100\text{mA}$ (Note 14) $I_{LOAD} = 100\text{mA}$ (Note 14)		●	300	350	mV 510
GND Pin Current $V_{IN} = V_{OUT(NOMINAL)} + 0.55\text{V}$ (Notes 6, 8)	$I_{LOAD} = 0\mu\text{A}$		●	40	80	μA
	$I_{LOAD} = 1\text{mA}$		●	60	100	μA
	$I_{LOAD} = 10\text{mA}$		●	160	350	μA
	$I_{LOAD} = 50\text{mA}$		●	0.8	1.8	mA
	$I_{LOAD} = 100\text{mA}$		●	2	4	mA
Quiescent Current in Shutdown	$V_{IN} = 45\text{V}$, $V_{SHDN} = 0\text{V}$			0.3	1	μA
ADJ Pin Bias Current (Note 9)	$V_{IN} = 2.1\text{V}$		●	15	60	nA
Output Voltage Noise	$C_{OUT} = 10\mu\text{F}$, $I_{LOAD} = 100\text{mA}$, $C_{BYP} = 0.01\mu\text{F}$ $V_{OUT} = 600\text{mV}$, $\text{BW} = 10\text{Hz}$ to 100kHz			30		μV_{RMS}
Shutdown Threshold	$V_{OUT} = \text{Off to On}$ $V_{OUT} = \text{On to Off}$		● ●	0.3	0.8 1.5	V V
SHDN Pin Current (Note 10)	$V_{SHDN} = 0\text{V}$		●		1	μA
	$V_{SHDN} = 45\text{V}$		●	0.9	3	μA
Ripple Rejection $V_{\text{RIPPLE}} = 0.5\text{V}_{\text{P-P}}$, $f_{\text{RIPPLE}} = 120\text{Hz}$, $I_{LOAD} = 100\text{mA}$	LT3060-1.2: $V_{IN} = 2.7\text{V}$ (Avg)			64	79	dB
	LT3060-1.5: $V_{IN} = 3\text{V}$ (Avg)			62	77	dB
	LT3060-1.8: $V_{IN} = 3.3\text{V}$ (Avg)			60	75	dB
	LT3060-2.5: $V_{IN} = 4\text{V}$ (Avg)			58	73	dB
	LT3060-3.3: $V_{IN} = 4.8\text{V}$ (Avg)			55	70	dB
	LT3060-5: $V_{IN} = 6.5\text{V}$ (Avg)			52	67	dB
	LT3060-15: $V_{IN} = 16.5\text{V}$ (Avg)			45	60	dB
	LT3060: $V_{IN} = 2.1\text{V}$ (Avg) (Note 4)			70	85	dB
Current Limit	$V_{IN} = 7\text{V}$, $V_{OUT} = 0$				200	mA
	$V_{IN} = V_{OUT(NOMINAL)} + 1\text{V}$ (Notes 6, 12), $\Delta V_{OUT} = -5\%$		●	110		mA

LT3060 Series

ELECTRICAL CHARACTERISTICS

The ● denotes the specifications which apply over the full operating temperature range, otherwise specifications are at $T_A = 25^\circ\text{C}$. (Note 3)

PARAMETER	CONDITIONS		MIN	TYP	MAX	UNITS
Input Reverse Leakage Current	$V_{IN} = -45\text{V}, V_{OUT} = 0$	●			300	μA
Reverse Output Current (Note 11)	LT3060-1.2: $V_{OUT} = 1.2\text{V}, V_{IN} = 0\text{V}$			5	10	μA
	LT3060-1.5: $V_{OUT} = 1.5\text{V}, V_{IN} = 0\text{V}$			5	10	μA
	LT3060-1.8: $V_{OUT} = 1.8\text{V}, V_{IN} = 0\text{V}$			5	10	μA
	LT3060-2.5: $V_{OUT} = 2.5\text{V}, V_{IN} = 0\text{V}$			5	10	μA
	LT3060-3.3: $V_{OUT} = 3.3\text{V}, V_{IN} = 0\text{V}$			5	10	μA
	LT3060-5: $V_{OUT} = 5\text{V}, V_{IN} = 0\text{V}$			5	10	μA
	LT3060-15: $V_{OUT} = 15\text{V}, V_{IN} = 0\text{V}$			5	10	μA
	LT3060: $V_{OUT} = 1.2\text{V}, V_{IN} = 0\text{V}$			0.2	10	μA

Note 1: Stresses beyond those listed under Absolute Maximum Ratings may cause permanent damage to the device. Exposure to any Absolute Maximum Rating condition for extended periods may affect device reliability and lifetime.

Note 2: Absolute maximum input-to-output differential voltage is not achievable with all combinations of rated IN pin and OUT pin voltages. With the IN pin at 50V, the OUT pin may not be pulled below 0V. The total measured voltage from IN to OUT must not exceed $\pm 50\text{V}$. If OUT is above ground, do not actively pull OUT above IN by more than 40V.

Note 3: The LT3060 regulators are tested and specified under pulse load conditions such that $T_J \approx T_A$. The LT3060E regulators are 100% tested at $T_A = 25^\circ\text{C}$. Performance at -40°C to 125°C is assured by design, characterization and correlation with statistical process controls. The LT3060I regulators are guaranteed over the full -40°C to 125°C operating junction temperature range. The LT3060MP regulators are 100% tested over the -55°C to 150°C operating junction temperature range. The LT3060H regulators are 100% tested at the 150°C operating junction temperature. High junction temperatures degrade operating lifetimes. Operating lifetime is derated at junction temperatures greater than 125°C .

Note 4: The LT3060 adjustable version is tested and specified for these conditions with the ADJ connected to the OUT pin.

Note 5: Maximum junction temperature limits operating conditions. The regulated output voltage specification does not apply for all possible combinations of input voltage and output current. Limit the output current range if operating at the maximum input-to-output voltage differential. Limit the input-to-output voltage differential if operating at maximum output current. Current limit foldback will limit the maximum output current as a function of input-to-output voltage. See Current Limit vs $V_{IN} - V_{OUT}$ in the Typical Performance Characteristics section.

Note 6: To satisfy minimum input voltage requirements, the LT3060 adjustable version is tested and specified for these conditions with an external resistor divider (bottom 115k, top 365k) for an output voltage of 2.5V. The external resistor divider adds $5\mu\text{A}$ of DC load on the output. This external current is not factored into GND pin current.

Note 7: Dropout voltage is the minimum input-to-output voltage differential needed to maintain regulation at a specified output current. In dropout, the output voltage equals: $(V_{IN} - V_{DROPOUT})$. For the LT3060, LT3060-1.2, LT3060-1.5 and LT3060-1.8, dropout is limited by the minimum input specification under some output voltages and load conditions. See the Minimum Input Voltage curve in the Typical Performance Characteristics section.

Note 8: GND pin current is tested with $V_{IN} = V_{OUT(NOMINAL)} + 0.55\text{V}$ and a current source load. GND pin current will increase in dropout. See GND pin current curves in the Typical Performance Characteristics section.

Note 9: ADJ pin bias current flows out of the ADJ pin.

Note 10: $\overline{\text{SHDN}}$ pin current flows into the $\overline{\text{SHDN}}$ pin.

Note 11: Reverse output current is tested with the IN pin grounded and the OUT pin forced to the rated output voltage. This current flows into the OUT pin and out of the GND pin.

Note 12: To satisfy requirements for minimum input voltage, current limit is tested at $V_{IN} = V_{OUT(NOMINAL)} + 1\text{V}$ or $V_{IN} = 2.1\text{V}$, whichever is greater.

Note 13: This IC includes overtemperature protection that protects the device during momentary overload conditions. Junction temperature will exceed 125°C (LT3060E, LT3060I) or 150°C (LT3060MP, LT3060H) when overtemperature circuitry is active. Continuous operation above the specified maximum junction temperature may impair device reliability.

Note 14: The dropout voltage specification is guaranteed for the DFN package. The dropout voltage specification for high output currents cannot be guaranteed for the TS8 package due to production test limitations.

Note 15: The load regulation specification is guaranteed for the fixed voltage options in the DFN package. The load regulation specification cannot be guaranteed for the fixed voltage options in the TS8 package due to production test limitations. The TS8 packages are tested similarly to the LT3060 adjustable version with the ADJ connected to the OUT pin.

TYPICAL PERFORMANCE CHARACTERISTICS $T_A = 25^\circ\text{C}$, unless otherwise noted.

Typical Dropout Voltage

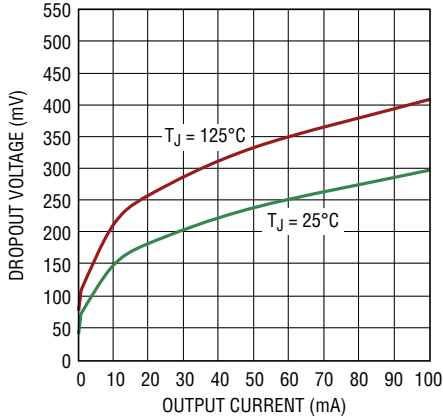

3060 G01

Guaranteed Dropout Voltage

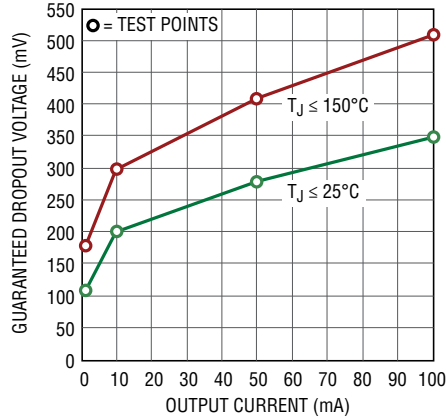

3060 G02

Dropout Voltage

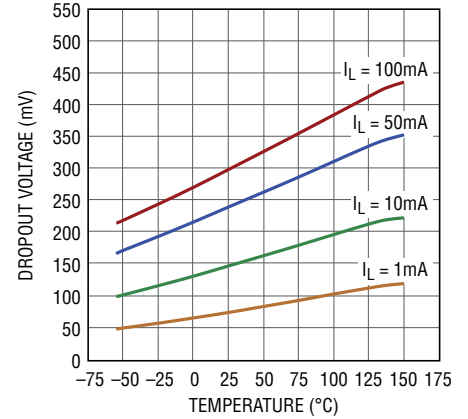

3060 G03

Quiescent Current

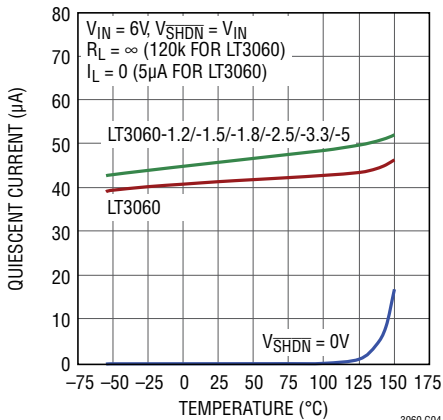

3060 G04

LT3060-1.2 Output Voltage

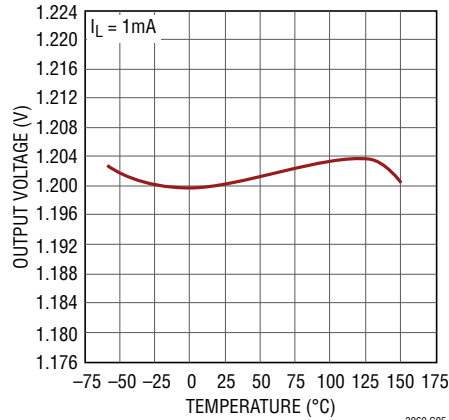

3060 G05

LT3060-1.5 Output Voltage

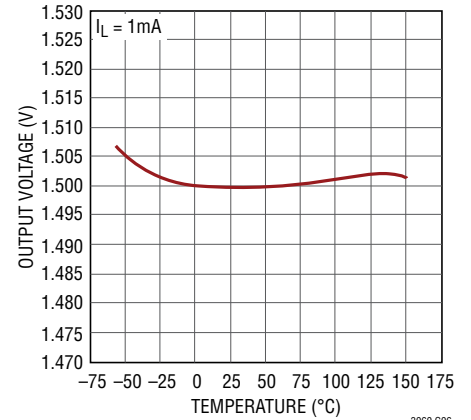

3060 G06

LT3060-1.8 Output Voltage

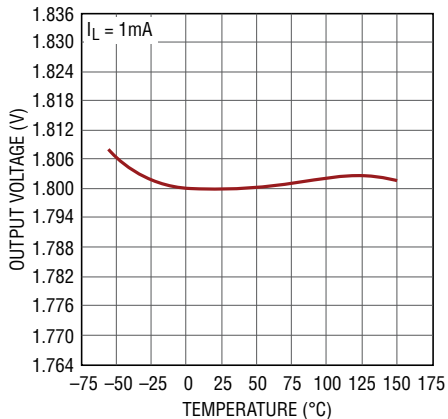

3060 G07

LT3060-2.5 Output Voltage

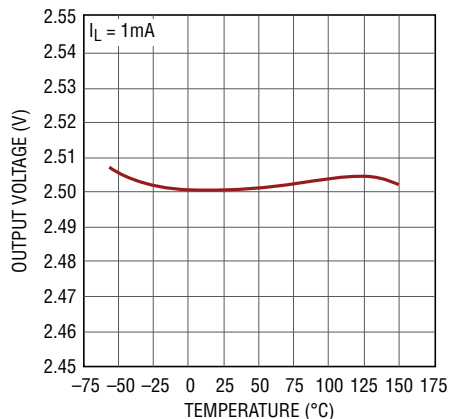

3060 G08

LT3060-3.3 Output Voltage

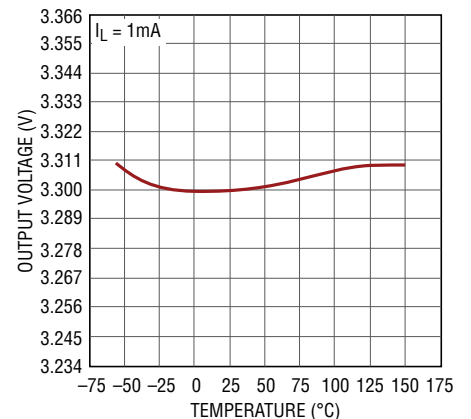

3060 G09

TYPICAL PERFORMANCE CHARACTERISTICS $T_A = 25^\circ\text{C}$, unless otherwise noted.

LT3060-5 Output Voltage



LT3060-15 Output Voltage

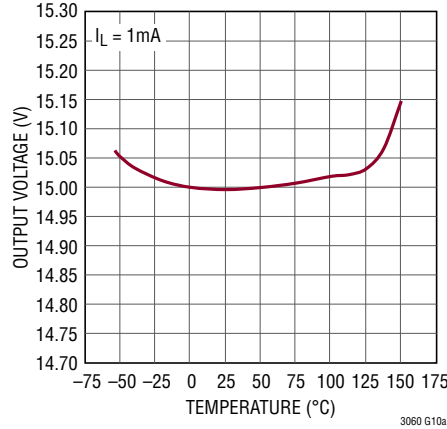

LT3060 ADJ Pin Voltage

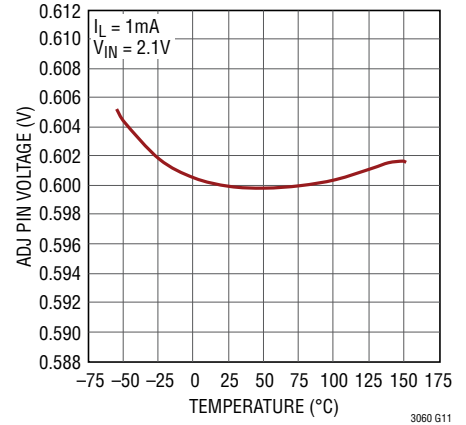

LT3060-1.2 Quiescent Current

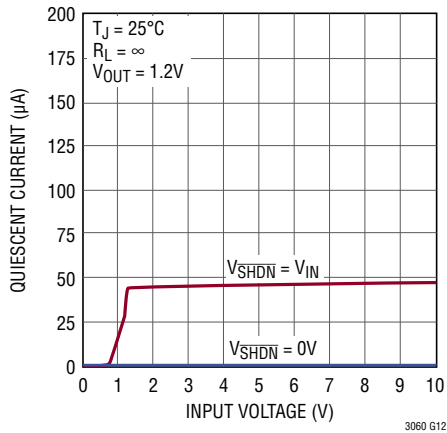

LT3060-1.5 Quiescent Current

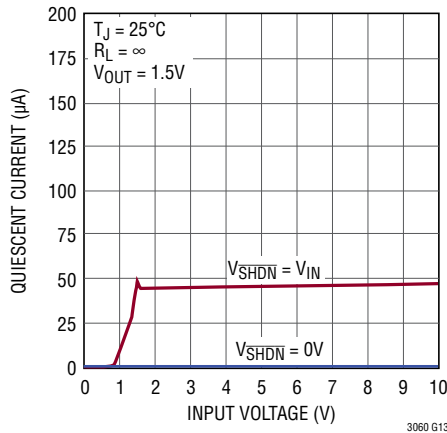

LT3060-1.8 Quiescent Current

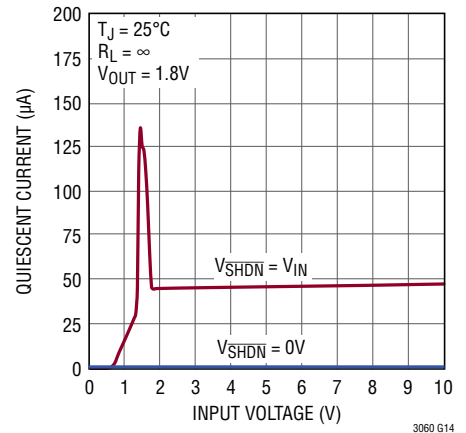

LT3060-2.5 Quiescent Current

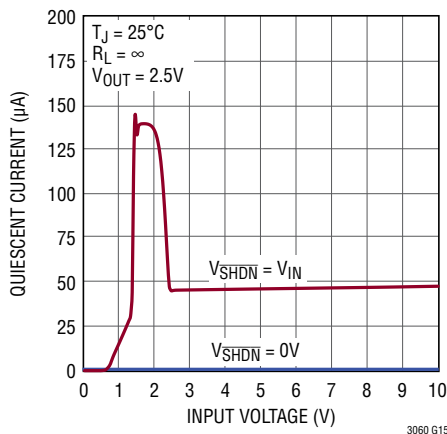

LT3060-3.3 Quiescent Current

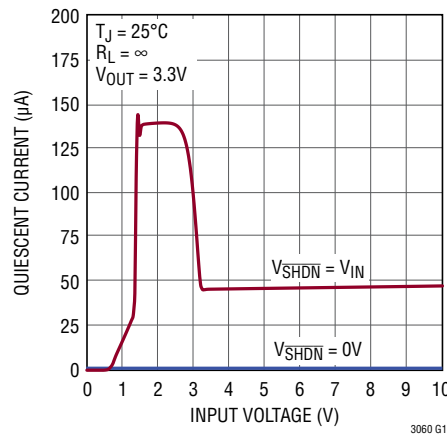

LT3060-5 Quiescent Current

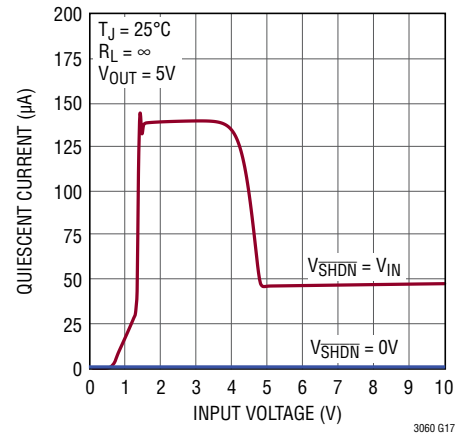

TYPICAL PERFORMANCE CHARACTERISTICS $T_A = 25^\circ\text{C}$, unless otherwise noted.

LT3060-15 Quiescent Current

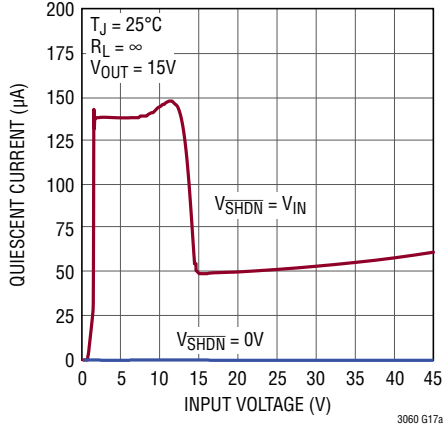

LT3060 Quiescent Current



LT3060-1.2 GND Pin Current

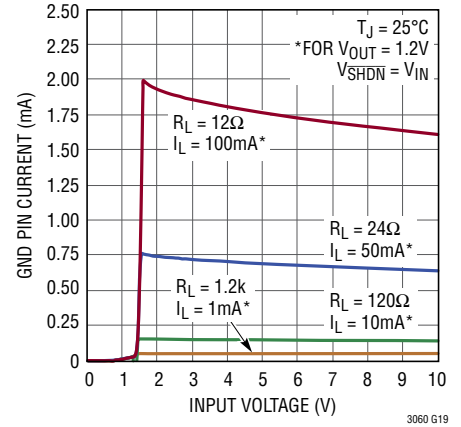

LT3060-1.5 GND Pin Current



LT3060-1.8 GND Pin Current



LT3060-2.5 GND Pin Current

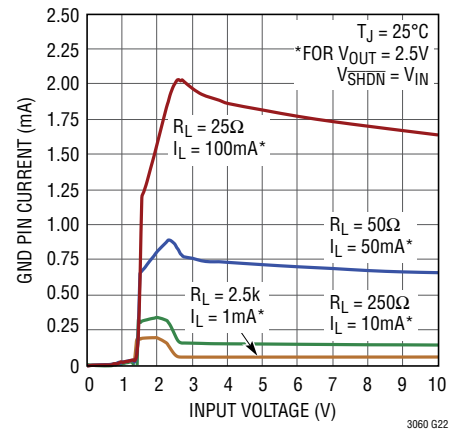

LT3060-3.3 GND Pin Current

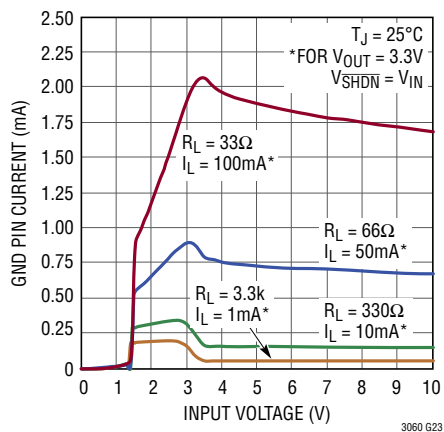

LT3060-5 GND Pin Current

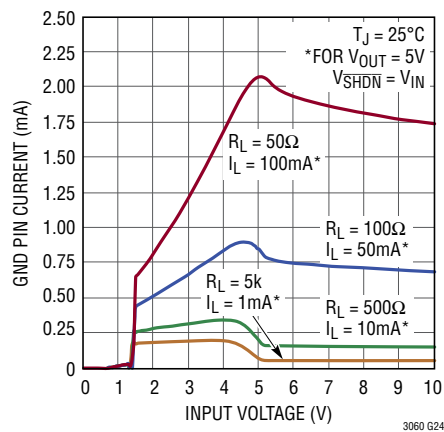

LT3060-15 GND Pin Current

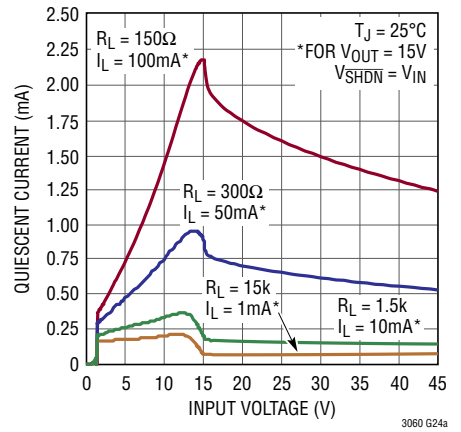

TYPICAL PERFORMANCE CHARACTERISTICS $T_A = 25^\circ\text{C}$, unless otherwise noted.

LT3060 GND Pin Current

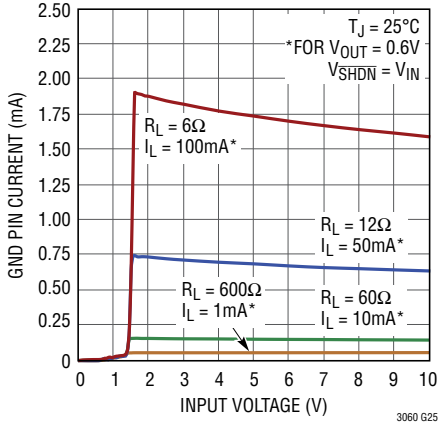

GND Pin Current vs I_{LOAD}

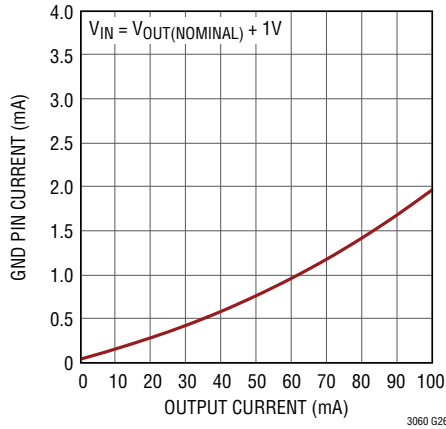

SHDN Pin Threshold

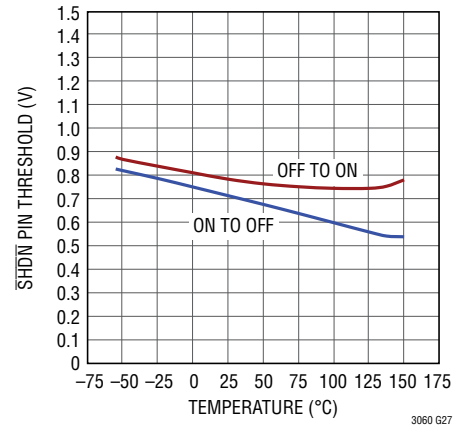

SHDN Pin Input Current

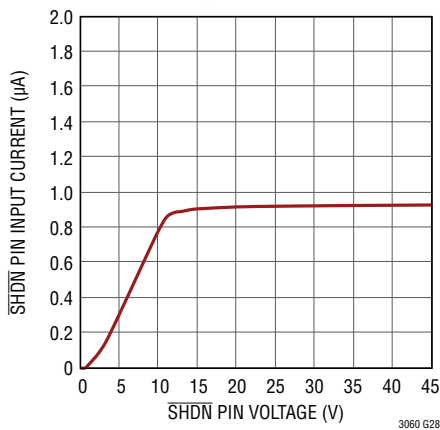

SHDN Pin Input Current

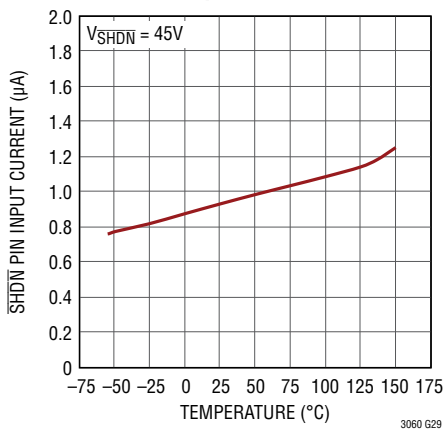

ADJ Pin Bias Current

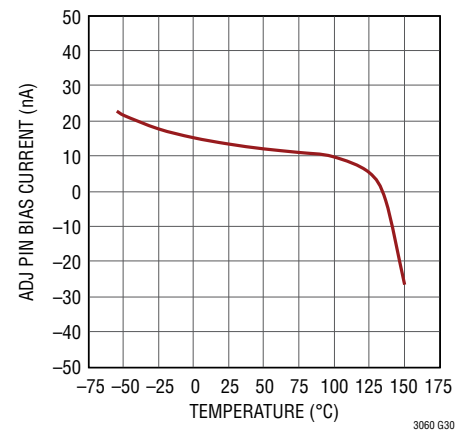

Current Limit vs $V_{IN}-V_{OUT}$

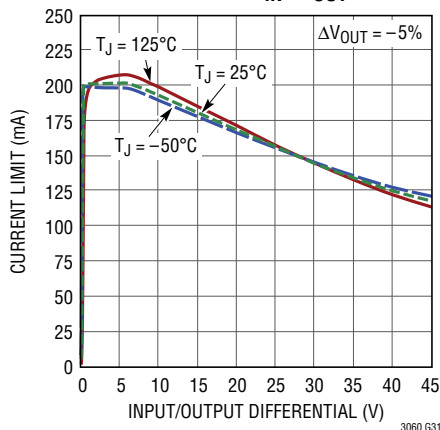

Current Limit vs Temperature

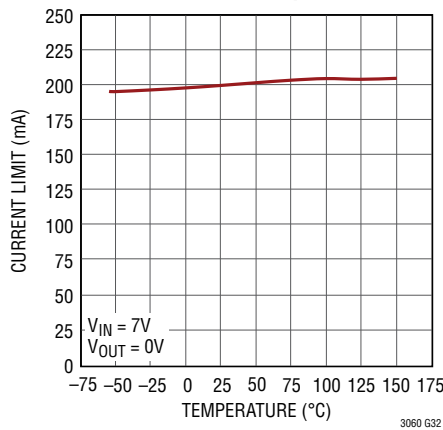

LT3060 Reverse Output Current

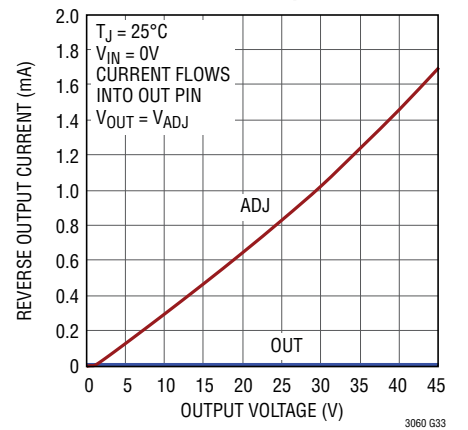

TYPICAL PERFORMANCE CHARACTERISTICS $T_A = 25^\circ\text{C}$, unless otherwise noted.

LT3060-1.2/-1.5/-1.8/-2.5/-3.3/-5/-15 Reverse Output Current

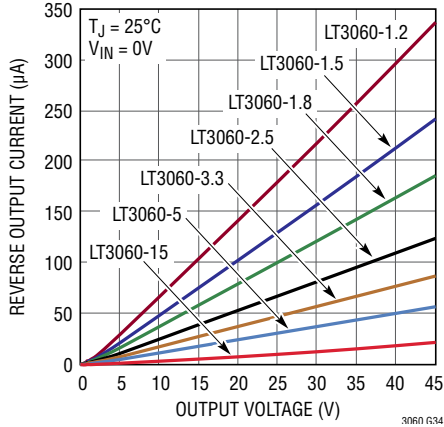

Reverse Output Current

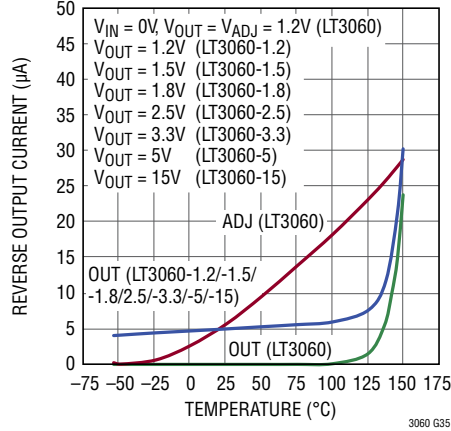

Input Ripple Rejection

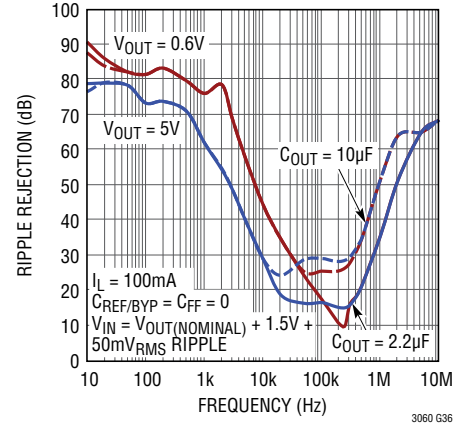

LT3060-5 Input Ripple Rejection



LT3060-15 Input Ripple Rejection

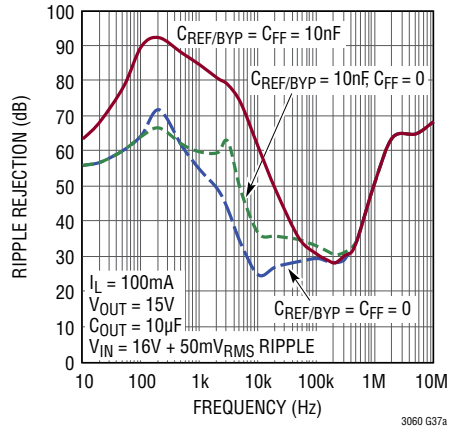

Ripple Rejection vs Temperature



Minimum Input Voltage

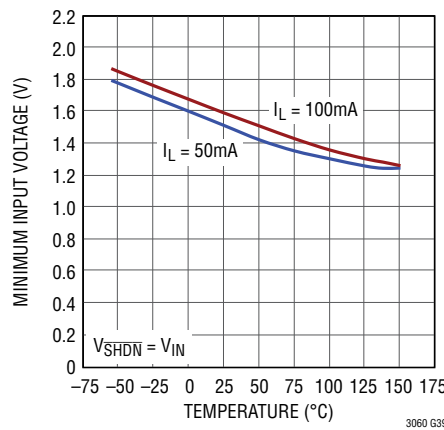

Load Regulation

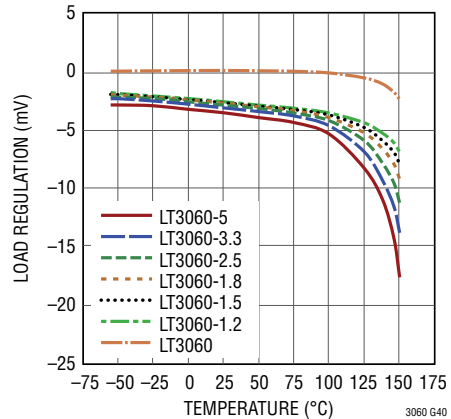

$V_{IN} = V_{OUT(NOMINAL)} + 0.55\text{V}$ (LT3060-1.8/-2.5/-3.3/-5)
 $V_{IN} = 2.1\text{V}$ (LT3060/-1.2/-1.5)
 $\Delta I_L = 1\text{mA TO } 100\text{mA}$

Load Regulation

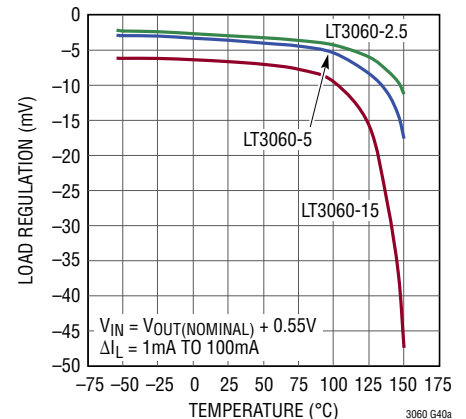

$V_{IN} = V_{OUT(NOMINAL)} + 0.55\text{V}$
 $\Delta I_L = 1\text{mA TO } 100\text{mA}$

TYPICAL PERFORMANCE CHARACTERISTICS $T_A = 25^\circ\text{C}$, unless otherwise noted.

Output Noise Spectral Density
 $C_{\text{REF/BYP}} = 0, C_{\text{FF}} = 0$



Output Noise Spectral Density vs $C_{\text{REF/BYP}}, C_{\text{FF}} = 0$



Output Noise Spectral Density vs $C_{\text{FF}}, C_{\text{REF/BYP}} = 10\text{nF}$

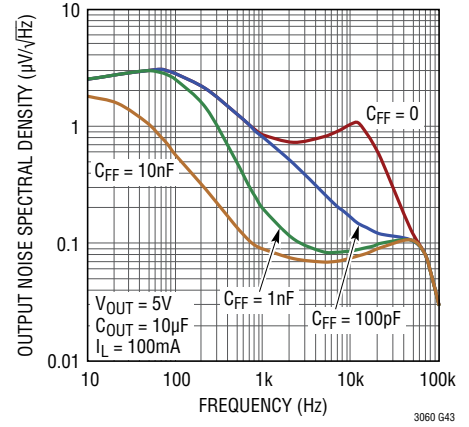

RMS Output Noise vs Load Current vs $C_{\text{REF/BYP}}, C_{\text{FF}} = 0$

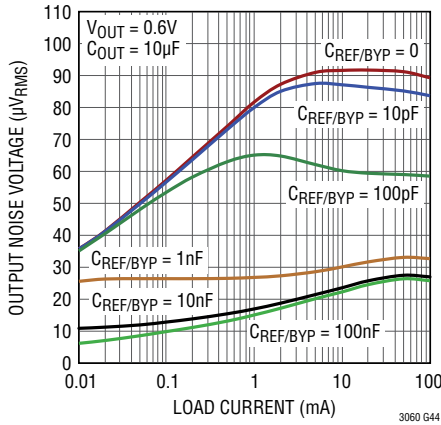

RMS Output Noise vs Load Current $C_{\text{REF/BYP}} = 10\text{nF}, C_{\text{FF}} = 0$



RMS Output Noise vs Load Current $C_{\text{REF/BYP}} = 10\text{nF}, C_{\text{FF}} = 0$

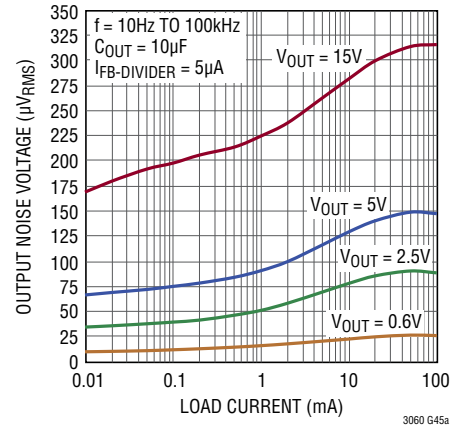

RMS Output Noise vs Feedforward Capacitor (C_{FF})



RMS Output Noise vs Feedforward Capacitor (C_{FF})

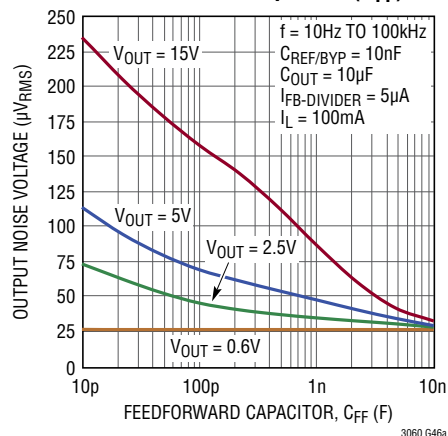

TYPICAL PERFORMANCE CHARACTERISTICS $T_A = 25^\circ\text{C}$, unless otherwise noted.

LT3060-5 10Hz to 100kHz Output Noise, $C_{\text{REF/BYP}} = 10\text{nF}$, $C_{\text{FF}} = 0$



LT3060-5 10Hz to 100kHz Output Noise, $C_{\text{REF/BYP}} = 10\text{nF}$, $C_{\text{FF}} = 10\text{nF}$



LT3060-5 Transient Response, $C_{\text{FF}} = 0$



LT3060-5 Transient Response, $C_{\text{FF}} = 10\text{nF}$



LT3060-5 Transient Response Load Dump



SHDN Transient Response $C_{\text{REF/BYP}} = 0$



SHDN Transient Response $C_{\text{REF/BYP}} = 10\text{nF}$



TYPICAL PERFORMANCE CHARACTERISTICS $T_A = 25^\circ\text{C}$, unless otherwise noted.



PIN FUNCTIONS (DC8/TS8)

REF/BYP (Pin 1/Pin 8): Reference/Bypass. Connecting a single capacitor from this pin to GND bypasses the LT3060's reference noise and soft-starts the reference. A 10nF bypass capacitor typically reduces output voltage noise to $30\mu\text{V}_{\text{RMS}}$ in a 10Hz to 100kHz bandwidth. Soft-start time is directly proportional to the REF/BYP capacitor value. If the LT3060 is placed in shutdown, REF/BYP is actively pulled low by an internal device to reset soft-start. If low noise or soft-start performance is not required, this pin must be left floating (unconnected). Do not drive this pin with any active circuitry.

ADJ (Pin 2/Pin 7): Adjust. This pin is the error amplifier's inverting terminal. It's typical bias current of 15nA flows out of the pin (see curve of ADJ Pin Bias Current vs Temperature in the Typical Performance Characteristics section). The ADJ pin voltage is 600mV referenced to GND.

Connecting a capacitor from ADJ to OUT reduces output noise and improves transient response for output voltages greater than 600mV. See the Applications Information section for calculating the value of the feedforward capacitor. For fixed voltage versions of the LT3060, if low noise and fast transient response is not required, this pin must be left floating (unconnected).

OUT (Pins 3, 4/Pin 6): Output. These pin(s) supply power to the load. Stability requirements demand a minimum 2.2 μF ceramic output capacitor to prevent oscillations. Large load transient applications require larger output capacitors to limit peak voltage transients. See the Applications Information section for details on transient response and reverse output characteristics. Permissible output voltage range is 600mV to 44.5V.

IN (Pins 5, 6/Pin 5): Input. These pin(s) supply power to the device. The LT3060 requires a local IN bypass capacitor if it is located more than six inches from the main input filter capacitor. In general, battery output impedance rises with frequency, so adding a bypass capacitor in battery-powered circuits is advisable.

An input bypass capacitor in the range of 1 μF to 10 μF suffices. The LT3060 withstands reverse voltages on the IN pin with respect to its GND and OUT pins. In a reversed input situation, such as a battery plugged in backwards, the LT3060 behaves as if a large resistor is in series with its input. Limited reverse current flows into the LT3060 and no reverse voltage appears at the load. The device protects itself and the load.

SHDN (Pin 7/Pin 1): Shutdown. Pulling the $\overline{\text{SHDN}}$ pin low puts the LT3060 into a low power state and turns the output off. Drive the $\overline{\text{SHDN}}$ pin with either logic or an open collector/drain with a pull-up resistor. The resistor supplies the pull-up current to the open collector/drain logic, normally several microamperes, and the $\overline{\text{SHDN}}$ pin current, typically less than 3 μA . If unused, connect the SHDN pin to IN. The LT3060 does not function if the $\overline{\text{SHDN}}$ pin is not connected. The $\overline{\text{SHDN}}$ pin cannot be driven below GND unless tied to the IN pin. If the $\overline{\text{SHDN}}$ pin is driven below GND while IN is powered, the output may turn on. $\overline{\text{SHDN}}$ pin logic cannot be referenced to a negative supply voltage.

GND (Pin 8, Exposed Pad Pin 9/Pins 2, 3, 4): Ground. For the adjustable LT3060, connect the bottom of the external resistor divider that sets the output voltage directly to GND for optimum regulation. For the DFN package, tie exposed pad Pin 9 directly to Pin 8 and the PCB ground. This exposed pad provides enhanced thermal performance with its connection to the PCB ground. See the Applications Information section for thermal considerations and calculating junction temperature.

APPLICATIONS INFORMATION

The LT3060 series are micropower, low noise, low dropout voltage, 100mA linear regulators with shutdown. The devices supply up to 100mA at a typical dropout voltage of 300mV and operate over a 1.6V to 45V input range.

A single external capacitor provides programmable low noise reference performance and output soft-start functionality. For example, connecting a 10nF capacitor from the REF/BYP pin to GND lowers output noise to $30\mu\text{V}_{\text{RMS}}$ over a 10Hz to 100kHz bandwidth. This capacitor also soft-starts the reference and prevents output voltage overshoot at turn-on.

The LT3060's quiescent current is merely $40\mu\text{A}$ for the adjustable version and $45\mu\text{A}$ for the fixed voltage versions, while providing fast transient response with a minimum low ESR 2.2 μF ceramic output capacitor. In shutdown, quiescent current is less than $1\mu\text{A}$ and the reference soft-start capacitor is reset.

The LT3060 regulators optimize stability and transient response with low ESR, ceramic output capacitors. The regulators do not require the addition of ESR as is common with other regulators. The LT3060 adjustable version typically provides 0.1% line regulation and 0.03% load regulation. For fixed voltage versions, load regulation is slightly increased due to $20\text{m}\Omega$ of typical resistance in series with the output. Curves of load regulation appear in the Typical Performance Characteristics section.

Internal protection circuitry includes reverse-battery protection, reverse-output protection, reverse-current protection, current limit with foldback and thermal shutdown.

This "bullet-proof" protection set makes it ideal for use in battery-powered systems. In battery backup applications where the output is held up by a backup battery and the input is pulled to ground, the LT3060 acts like it has a diode in series with its output and prevents reverse current flow. Additionally, in dual supply applications where the regulator load is returned to a negative supply, the output can be pulled below ground by as much as 45V and the device still starts normally and operates.

Adjustable Operation

The LT3060 adjustable version has an output voltage range of 0.6V to 44.5V. The output voltage is set by the ratio of two external resistors, as shown in Figure 1. The device servos the output to maintain the ADJ pin voltage at 0.6V referenced to ground. The current in R1 is then equal to $0.6\text{V}/\text{R1}$, and the current in R2 is the current in R1 minus the ADJ pin bias current. The ADJ pin bias current, 15nA at 25°C , flows from the ADJ pin through R1 to GND. Calculate the output voltage using the formula in Figure 1. The value of R1 should be no greater than 124k to provide a minimum $5\mu\text{A}$ load current so that errors in the output voltage, caused by the ADJ pin bias current, are minimized. Note that in shutdown, the output is turned off and the divider current is zero. Curves of ADJ Pin Voltage vs Temperature and ADJ Pin Bias Current vs Temperature appear in the Typical Performance Characteristics section.

The adjustable device is tested and specified with the ADJ pin tied to the OUT pin, yielding $V_{\text{OUT}} = 0.6\text{V}$. Specifications for output voltages greater than 0.6V are proportional to the ratio of the desired output voltage to 0.6V: $V_{\text{OUT}}/0.6\text{V}$. For example, load regulation for an output current change of 1mA to 100mA is 0.2mV (typical) at $V_{\text{OUT}} = 0.6\text{V}$. At $V_{\text{OUT}} = 12\text{V}$, load regulation is:

$$\frac{12\text{V}}{0.6\text{V}} \cdot (0.2\text{mV}) = 4\text{mV}$$

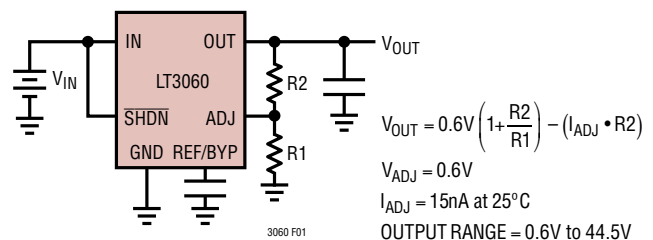

Figure 1. Adjustable Operation

APPLICATIONS INFORMATION

Table 1 shows 1% resistor divider values for some common output voltages with a resistor divider current of about 5µA.

Table 1. Output Voltage Resistor Divider Values

V _{OUT} (V)	R1 (kΩ)	R2 (kΩ)
1.2	118	118
1.5	121	182
1.8	124	249
2.5	115	365
3	124	499
3.3	124	562
5	115	845
12	124	2370
15	124	3010

Bypass Capacitance, Output Voltage Noise and Transient Response

The LT3060 regulators provide low output voltage noise over the 10Hz to 100kHz bandwidth while operating at full load with the addition of a reference bypass capacitor (C_{REF/BYP}) from the REF/BYP pin to GND. A good quality, low leakage capacitor is recommended. This capacitor bypasses the internal reference of the regulator, providing a low frequency noise pole. With the use of 10nF for C_{REF/BYP}, the output voltage noise decreases to as low as 30µV_{RMS} when the output voltage is set for 0.6V. For higher output voltages (generated by using a feedback resistor divider), the output voltage noise gains up accordingly when using C_{REF/BYP} by itself.

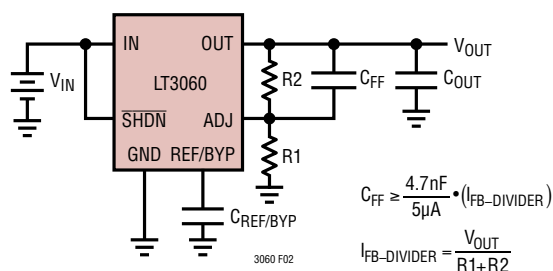

Figure 2. Feedforward Capacitor for Fast Transient Response

To lower the output voltage noise for higher output voltages, include a feedforward capacitor (C_{FF}) from V_{OUT} to the ADJ pin. A good quality, low leakage capacitor is recommended. This capacitor bypasses the error amplifier of the regulator, providing a low frequency noise pole. With the use of 10nF for both C_{FF} and C_{REF/BYP}, output voltage noise decreases to 30µV_{RMS} when the output voltage is set to 5V by a 5µA feedback resistor divider. If the current in the feedback resistor divider is doubled, C_{FF} must also be doubled to achieve equivalent noise performance.

Higher values of output voltage noise are often measured if care is not exercised with regard to circuit layout and testing. Crosstalk from nearby traces induces unwanted noise onto the LT3060's output. Power supply ripple rejection must also be considered. The LT3060 regulators do not have unlimited power supply rejection and will pass a small portion of the input noise through to the output.

Using a feedforward capacitor (C_{FF}) from V_{OUT} to the ADJ pin has the added benefit of improving transient response for output voltages greater than 0.6V. With no feedforward capacitor, the settling time will increase as the output voltage is raised above 0.6V. Use the equation in Figure 2 to determine the minimum value of C_{FF} to achieve a transient response that is similar to 0.6V output voltage performance regardless of the chosen output voltage (see Figure 3 and Transient Response in the Typical Performance Characteristics section).



Figure 3. Transient Response vs Feedforward Capacitor

APPLICATIONS INFORMATION

During start-up, the internal reference soft-starts if a reference bypass capacitor is present. Regulator start-up time is directly proportional to the size of the bypass capacitor, slowing to 6ms with a 10nF bypass capacitor (See Start-up Time vs REF/BYP Capacitor in the Typical Performance Characteristics section). The reference bypass capacitor is actively pulled low during shutdown to reset the internal reference.

Start-up time is also affected by the use of a feedforward capacitor. Start-up time is directly proportional to the size of the feedforward capacitor and output voltage, and is inversely proportional to the feedback resistor divider current, slowing to 15ms with a 4.7nF feedforward capacitor and a 10 μ F output capacitor for an output voltage set to 5V by a 5 μ A feedback resistor divider.

Output Capacitance

The LT3060 regulators are stable with a wide range of output capacitors. The ESR of the output capacitor affects stability, most notably with small capacitors. Use a minimum output capacitor of 2.2 μ F with an ESR of 3 Ω or less to prevent oscillations. If a feedforward capacitor is used with output voltages set for greater than 24V, use a minimum output capacitor of 4.7 μ F. The LT3060 is a micropower device and output load transient response is a function of output capacitance. Larger values of output capacitance decrease the peak deviations and provide improved transient response for larger load current

changes. Bypass capacitors, used to decouple individual components powered by the LT3060, increase the effective output capacitor value. For applications with large load current transients, a low ESR ceramic capacitor in parallel with a bulk tantalum capacitor often provides an optimally damped response.

Give extra consideration to the use of ceramic capacitors. Manufacturers make ceramic capacitors with a variety of dielectrics, each with different behavior across temperature and applied voltage. The most common dielectrics are specified with EIA temperature characteristic codes of Z5U, Y5V, X5R and X7R. The Z5U and Y5V dielectrics provide high C-V products in a small package at low cost, but exhibit strong voltage and temperature coefficients, as shown in Figures 4 and 5. When used with a 5V regulator, a 16V 10 μ F Y5V capacitor can exhibit an effective value as low as 1 μ F to 2 μ F for the DC bias voltage applied, and over the operating temperature range. The X5R and X7R dielectrics yield much more stable characteristics and are more suitable for use as the output capacitor.

The X7R type works over a wider temperature range and has better temperature stability, while the X5R is less expensive and is available in higher values. Care still must be exercised when using X5R and X7R capacitors; the X5R and X7R codes only specify operating temperature range and maximum capacitance change over temperature. Capacitance change due to DC bias with X5R and X7R capacitors is better than Y5V and Z5U

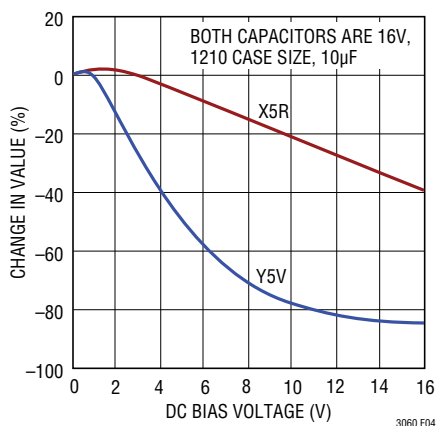

Figure 4. Ceramic Capacitor DC Bias Characteristics

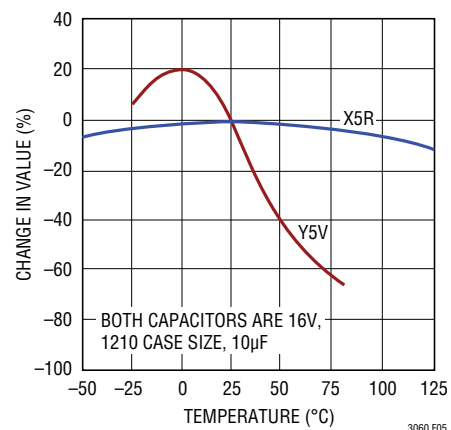

Figure 5. Ceramic Capacitor Temperature Characteristics

APPLICATIONS INFORMATION

capacitors, but can still be significant enough to drop capacitor values below appropriate levels. Capacitor DC bias characteristics tend to improve as component case size increases, but expected capacitance at operating voltage should be verified.

Voltage and temperature coefficients are not the only sources of problems. Some ceramic capacitors have a piezoelectric response. A piezoelectric device generates voltage across its terminals due to mechanical stress, similar to the way a piezoelectric accelerometer or microphone works. For a ceramic capacitor, the stress is induced by vibrations in the system or thermal transients. The resulting voltages produced cause appreciable amounts of noise. A ceramic capacitor produced the trace in Figure 6 in response to light tapping from a pencil. Similar vibration induced behavior can masquerade as increased output voltage noise.



Figure 6. Noise Resulting from Tapping on a Ceramic Capacitor

Overload Recovery

Like many IC power regulators, the LT3060 has safe operating area protection. The safe operating area protection decreases current limit as input-to-output voltage increases, and keeps the power transistor inside a safe operating region for all values of input-to-output voltage. The LT3060 provides some output current at all values of input-to-output voltage up to the specified 45V operational maximum.

When power is first applied, the input voltage rises and the output follows the input; allowing the regulator to start-up into very heavy loads. During start-up, as the input voltage is rising, the input-to-output voltage differential is small,

allowing the regulator to supply large output currents. With a high input voltage, a problem can occur wherein the removal of an output short will not allow the output to recover. Other regulators, such as the LT1083/LT1084/LT1085 family and LT1764A also exhibit this phenomenon, so it is not unique to the LT3060. The problem occurs with a heavy output load when the input voltage is high and the output voltage is low. Common situations are: (1) immediately after the removal of a short-circuit or (2) if the shutdown pin is pulled high after the input voltage is already turned on. The load line intersects the output current curve at two points creating two stable output operating points for the regulator. With this double intersection, the input power supply needs to be cycled down to zero and brought up again for the output to recover.

Thermal Considerations

The power handling capability of the device will be limited by the maximum rated junction temperature (125°C for LT3060E, LT3060I or 150°C for LT3060MP, LT3060H). Two components comprise the power dissipated by the device:

1. Output current multiplied by the input/output voltage differential: $I_{OUT} \cdot (V_{IN} - V_{OUT})$, and
2. GND pin current multiplied by the input voltage: $I_{GND} \cdot V_{IN}$

GND pin current is determined using the GND Pin Current curves in the Typical Performance Characteristics section. Power dissipation equals the sum of the two components listed above.

The LT3060 regulators have internal thermal limiting that protects the device during overload conditions. For continuous normal conditions, the maximum junction temperature of 125°C (E-grade, I-grade) or 150°C (MP-grade, H-grade) must not be exceeded. Carefully consider all sources of thermal resistance from junction-to-ambient including other heat sources mounted in proximity to the LT3060.

The underside of the LT3060 DFN package has exposed metal (1mm²) from the lead frame to the die attachment. The package allows heat to directly transfer from the die junction to the printed circuit board metal to control maximum operating junction temperature. The dual-in-line pin arrangement allows metal to extend beyond the ends of

APPLICATIONS INFORMATION

the package on the topside (component side) of a PCB. Connect this metal to GND on the PCB. The multiple IN and OUT pins of the LT3060 also assist in spreading heat to the PCB.

For surface mount devices, heat sinking is accomplished by using the heat spreading capabilities of the PC board and its copper traces. Copper board stiffeners and plated through-holes also can spread the heat generated by power devices.

Tables 2 and 3 list thermal resistance for several different board sizes and copper areas. All measurements were taken in still air on a 4 layer FR-4 board with 1oz solid internal planes and 2oz top/bottom external trace planes with a total board thickness of 1.6mm. The four layers were electrically isolated with no thermal vias present. PCB layers, copper weight, board layout and thermal vias will affect the resultant thermal resistance. For more information on thermal resistance and high thermal conductivity test boards, refer to JEDEC standard JESD51, notably JESD51-12 and JESD51-7. Achieving low thermal resistance necessitates attention to detail and careful PCB layout.

Table 2. DC Package, 8-Lead DFN

COPPER AREA		BOARD AREA (mm ²)	THERMAL RESISTANCE (JUNCTION-TO-AMBIENT)
TOPSIDE* (mm ²)	BACKSIDE (mm ²)		
2500	2500	2500	48°C/W
1000	2500	2500	49°C/W
225	2500	2500	50°C/W
100	2500	2500	54°C/W
50	2500	2500	60°C/W

*Device is mounted on topside

Table 3. TS8 Package, 8 Lead TSOT-23

COPPER AREA		BOARD AREA (mm ²)	THERMAL RESISTANCE (JUNCTION-TO-AMBIENT)
TOPSIDE* (mm ²)	BACKSIDE (mm ²)		
2500	2500	2500	57°C/W
1000	2500	2500	58°C/W
225	2500	2500	59°C/W
100	2500	2500	63°C/W
50	2500	2500	67°C/W

*Device is mounted on topside

Calculating Junction Temperature

Example: Given an output voltage of 2.5V, an input voltage range of 12V ±5%, an output current range of 0mA to 50mA and a maximum ambient temperature of 85°C, what will the maximum junction temperature be?

The power dissipated by the device equals:

$$I_{OUT(MAX)} \cdot (V_{IN(MAX)} - V_{OUT}) + I_{GND} \cdot V_{IN(MAX)}$$

where,

$$I_{OUT(MAX)} = 50\text{mA}$$

$$V_{IN(MAX)} = 12.6\text{V}$$

$$I_{GND} \text{ at } (I_{OUT} = 50\text{mA}, V_{IN} = 12.6\text{V}) = 0.6\text{mA}$$

So,

$$P = 50\text{mA} \cdot (12.6\text{V} - 2.5\text{V}) + 0.6\text{mA} \cdot 12.6\text{V} = 0.513\text{W}$$

Using a DFN package, the thermal resistance ranges from 48°C/W to 60°C/W depending on the copper area with no thermal vias. So the junction temperature rise above ambient approximately equals:

$$0.513\text{W} \cdot 54^\circ\text{C/W} = 27.8^\circ\text{C}$$

The maximum junction temperature equals the maximum ambient temperature plus the maximum junction temperature rise above ambient or:

$$T_{JMAX} = 85^\circ\text{C} + 27.8^\circ\text{C} = 112.8^\circ\text{C}$$

Protection Features

The LT3060 regulators incorporate several protection features that make it ideal for use in battery-powered circuits. In addition to the normal protection features associated with monolithic regulators, such as current limiting and thermal limiting, the device also protects against reverse-input voltages, reverse-output voltages and reverse output-to-input voltages.

Current limit protection and thermal overload protection protect the device against current overload conditions at the output of the device. The typical thermal shutdown temperature is 165°C. For normal operation, do not exceed a junction temperature of 125°C (LT3060E, LT3060I) or 150°C (LT3060MP, LT3060H).

APPLICATIONS INFORMATION

The LT3060 IN pin withstands reverse voltages up to 50V. The device limits current flow to less than 300 μ A (typically less than 50 μ A) and no negative voltage appears at OUT. The device protects both itself and the load against batteries that are plugged in backwards.

The $\overline{\text{SHDN}}$ pin cannot be driven below GND unless tied to the IN pin. If the $\overline{\text{SHDN}}$ pin is driven below GND while IN is powered, the output may turn on. $\overline{\text{SHDN}}$ pin logic cannot be referenced to a negative supply voltage.

The LT3060 incurs no damage if its output is pulled below ground. If the input is left open-circuit or grounded, the output can be pulled below ground by 50V. No current flows through the pass transistor from the output. However, current flows in (but is limited by) the resistor divider that sets the output voltage. Current flows from the bottom resistor in the divider and from the ADJ pin's internal clamp through the top resistor in the divider to the external circuitry pulling OUT below ground. If the input is powered by a voltage source, the output sources current equal to its current limit capability and the LT3060 protects itself by thermal limiting. In this case, grounding the $\overline{\text{SHDN}}$ pin turns off the device and stops the output from sourcing current.

The LT3060 incurs no damage if the ADJ pin is pulled above or below ground by less than 50V. For the adjustable version, if the input is left open-circuit or grounded, the ADJ pin performs like a large resistor (typically 30k) in series with a diode when pulled below ground, and like 30k in series with two diodes when pulled above ground.

In circuits where a backup battery is required, several different input/output conditions can occur. The output voltage may be held up while the input is either pulled to ground, pulled to some intermediate voltage or left open-circuit. Current flow back into the output follows the curve shown in Figures 7 and 8.

If the LT3060's IN pin is forced below the OUT pin or the OUT pin is pulled above the IN pin, input current typically drops to less than 1 μ A. This occurs if the LT3060 input is connected to a discharged (low voltage) battery and either a backup battery or a second regulator holds up the output. The state of the $\overline{\text{SHDN}}$ pin has no effect on the reverse current if the output is pulled above the input.

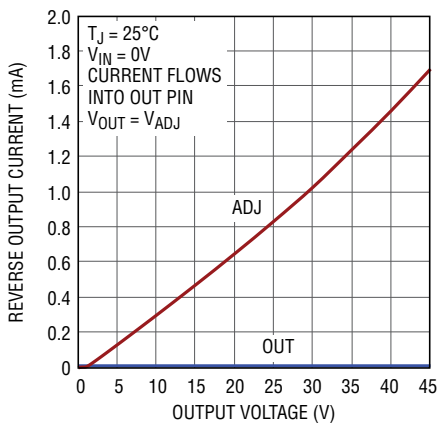

Figure 7. LT3060 Reverse Output Current

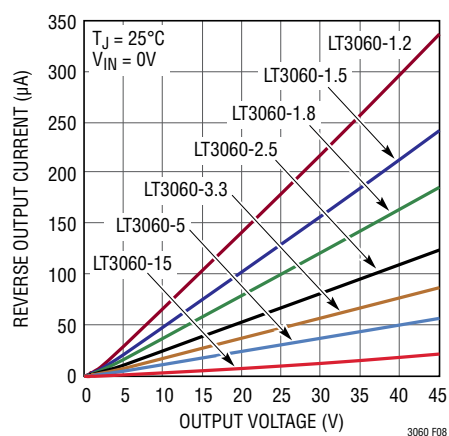
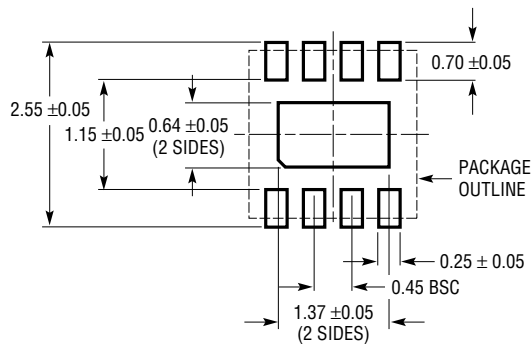

Figure 8. LT3060-1.2/-1.5/-1.8/-2.5/-3.3/-5/-15 Reverse Output Current

PACKAGE DESCRIPTION

DC Package
8-Lead Plastic DFN (2mm × 2mm)
 (Reference LTC DWG # 05-08-1719 Rev A)



RECOMMENDED SOLDER PAD PITCH AND DIMENSIONS
 APPLY SOLDER MASK TO AREAS THAT ARE NOT SOLDERED

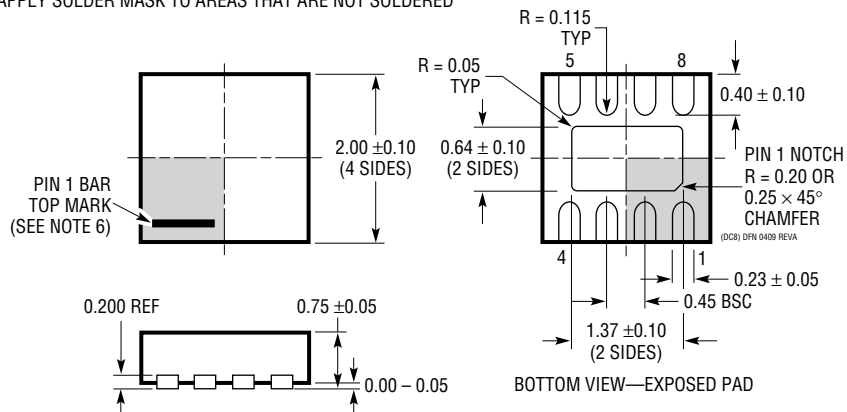

- NOTE:
1. DRAWING IS NOT A JEDEC PACKAGE OUTLINE
 2. DRAWING NOT TO SCALE
 3. ALL DIMENSIONS ARE IN MILLIMETERS
 4. DIMENSIONS OF EXPOSED PAD ON BOTTOM OF PACKAGE DO NOT INCLUDE MOLD FLASH. MOLD FLASH, IF PRESENT, SHALL NOT EXCEED 0.15mm ON ANY SIDE
 5. EXPOSED PAD SHALL BE SOLDER PLATED
 6. SHADED AREA IS ONLY A REFERENCE FOR PIN 1 LOCATION ON THE TOP AND BOTTOM OF PACKAGE

PACKAGE DESCRIPTION

TS8 Package
8-Lead Plastic TSOT-23
 (Reference LTC DWG # 05-08-1637 Rev A)

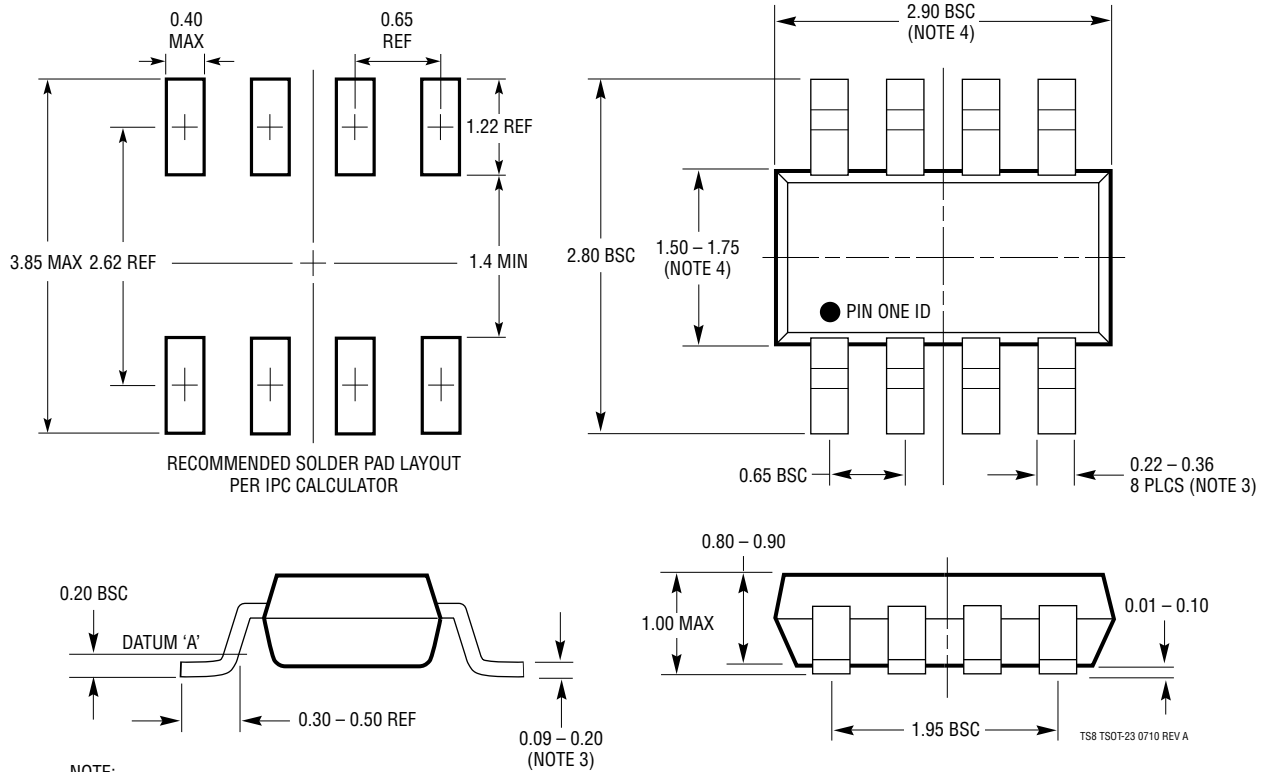

- NOTE:
1. DIMENSIONS ARE IN MILLIMETERS
 2. DRAWING NOT TO SCALE
 3. DIMENSIONS ARE INCLUSIVE OF PLATING
 4. DIMENSIONS ARE EXCLUSIVE OF MOLD FLASH AND METAL BURR
 5. MOLD FLASH SHALL NOT EXCEED 0.254mm
 6. JEDEC PACKAGE REFERENCE IS MO-193

TS8 TSOT-23 0710 REV A

REVISION HISTORY

REV	DATE	DESCRIPTION	PAGE NUMBER
A	7/10	Added fixed voltage options for 1.2V, 1.5V, 1.8V, 2.5V, 3.3V and 5V	1-26
B	5/11	Extended MP-Grade to 150°C Updated test conditions for ADJ Pin Bias Current and Reverse Output Current in Applications Information section	2-7 19-20
C	9/14	Added fixed voltage options for 15V Updated available packaging in Related Parts section	1 to 14, 17, 21 26
D	05/21	Added AEC-Q100 Qualified for Automotive Applications to Features table Replaced Lead Free Finish with Tape And Reel (Mini) Replaced suffix PBF with TRMPBF Added "AUTOMOTIVE PRODUCTS*" Table + Supplemental Text"	1 2, 3 2, 3 3

TYPICAL APPLICATION

12V Low Noise Regulator

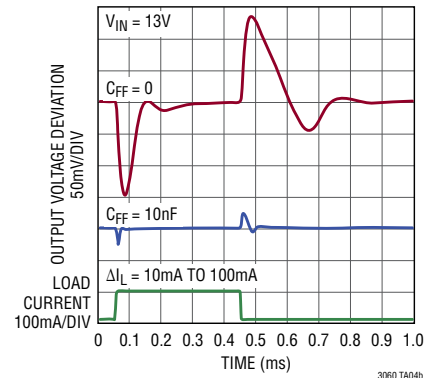
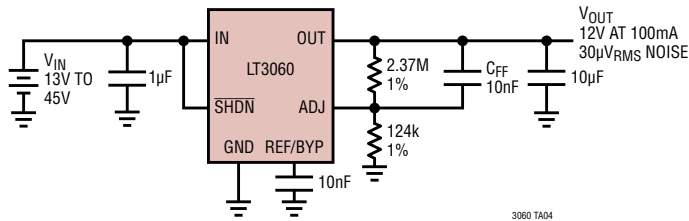

RELATED PARTS

PART NUMBER	DESCRIPTION	COMMENTS
LT1761	100mA, Low Noise LDO	300mV Dropout Voltage, Low Noise: 20µVRMS, VIN = 1.8V to 20V, ThinSOT Package
LT1762	150mA, Low Noise LDO	300mV Dropout Voltage, Low Noise: 20µVRMS, VIN = 1.8V to 20V, MS8 Package
LT1763	500mA, Low Noise LDO	300mV Dropout Voltage, Low Noise: 20µVRMS, VIN = 1.8V to 20V, SO8 and 4mm × 3mm DFN Packages
LT1764/ LT1764A	3A, Fast Transient Response, Low Noise LDO	340mV Dropout Voltage, Low Noise: 40µVRMS, VIN = 2.7V to 20V, TO-220 and DD Packages, LT1764A Version Stable Also with Ceramic Capacitors
LT1962	300mA, Low Noise LDO	270mV Dropout Voltage, Low Noise: 20µVRMS, VIN = 1.8V to 20V, MS8 Package
LT1963/ LT1963A	1.5A Low Noise, Fast Transient Response LDO	340mV Dropout Voltage, Low Noise: 40µVRMS, VIN = 2.5V to 20V, LT1963A Version Stable with Ceramic Capacitors; TO-220, DD, SOT-223 and SO8 Packages
LT1964	200mA, Low Noise, Negative LDO	340mV Dropout Voltage, Low Noise 30µVRMS, VIN = -1.8V to -20V, ThinSOT and 3mm × 3mm DFN Packages
LT1965	1.1A, Low Noise, Low Dropout Linear Regulator	290mV Dropout Voltage, Low Noise: 40µVRMS, VIN: 1.8V to 20V, VOUT: 1.2V to 19.5V, Stable with Ceramic Capacitors; TO-220, DD-Pak, MSOP and 3mm × 3mm DFN Packages
LT3008	20mA, 45V, 3µA IQ Micropower LDO	300mV Dropout Voltage, Low IQ: 3µA, VIN = 2V to 45V, VOUT = 0.6V to 39.5V; ThinSOT and 2mm × 2mm DFN-6 Packages
LT3009	20mA, 3µA IQ Micropower LDO	280mV Dropout Voltage, Low IQ: 3µA, VIN = 1.6V to 20V, 2mm × 2mm DFN and SC70 Packages
LT3050	100mA, Low Noise Linear Regulator with Precision Current Limit and Diagnostic Functions.	340mV Dropout Voltage, Low Noise: 30µVRMS, VIN: 1.6V to 45V, VOUT: 0.6V to 44.5V, Programmable Precision Current Limit: ±5%, Programmable Minimum IOUT Monitor, Output Current Monitor, Fault Indicator, Reverse Protection; 12-Lead 2mm × 3mm DFN and MSOP Packages.
LT3080/ LT3080-1	1.1A, Parallelable, Low Noise, Low Dropout Linear Regulator	300mV Dropout Voltage (2-Supply Operation), Low Noise: 40µVRMS, VIN: 1.2V to 36V, VOUT: 0V to 35.7V, Current-Based Reference with 1-Resistor VOUT Set; Directly Parallelable (No Op Amp Required), Stable with Ceramic Capacitors; TO-220, SOT-223, MSOP and 3mm × 3mm DFN Packages; LT3080-1 Version Has Integrated Internal Ballast Resistor
LT3082	200mA, Parallelable, Single Resistor, Low Dropout Linear Regulator	Outputs May Be Paralleled for Higher Output, Current or Heat Spreading, Wide Input Voltage Range: 1.2V to 40V Low Value Input/Output Capacitors Required: 0.22µF, Single Resistor Sets Output Voltage, Initial Set Pin Current Accuracy: 1%, Low Output Noise: 40µVRMS (10Hz to 100kHz) Reverse-Battery Protection, Reverse-Current Protection; 8-Lead SOT-23, 3-Lead SOT-223 and 8-Lead 3mm × 3mm DFN Packages
LT3085	500mA, Parallelable, Low Noise, Low Dropout Linear Regulator	275mV Dropout Voltage (2-Supply Operation), Low Noise: 40µVRMS, VIN: 1.2V to 36V, VOUT: 0V to 35.7V, Current-Based Reference with 1-Resistor VOUT Set, Directly Parallelable (No Op Amp Required), Stable with Ceramic Capacitors; MS8E and 2mm × 3mm DFN-6 Packages
LT3092	200mA 2-Terminal Programmable Current Source	Programmable 2-Terminal Current Source, Maximum Output Current: 200mA, Wide Input Voltage Range: 1.2V to 40V, Resistor Ratio Sets Output Current, Initial Set Pin Current Accuracy: 1%, Current Limit and Thermal Shutdown Protection, Reverse-Voltage Protection, Reverse-Current Protection; 8-Lead SOT-23, 3-Lead SOT-223 and 8-Lead 3mm × 3mm DFN Packages

Rev. D

Looking for pricing, stock, or lifecycle information?

Click below to explore more details on WIN SOURCE:

 [View LT3060IDC#TRPBF on WIN SOURCE](#)

 [Analog Devices Inc. Information](#)

Optimize Your Supply Chain with WIN SOURCE Solutions

-  Global Sourcing Solution
-  Obsolete Management
-  Cost Control Management
-  Shortage Management
-  Alternative Solution
-  Excess Inventory Management