



**THE DATASHEET OF
MAXM38643AEMB+**



Click [here](#) to ask an associate for production status of specific part numbers.

Tiny, 1.8V to 5.5V Input, 330nA I_Q, 600mA nanoPower Buck Module

MAXM38643

Product Highlights

- Extends Battery Life
 - 330nA Ultra-Low Quiescent Supply Current
 - 1nA Shutdown Current
 - 96% Peak Efficiency and over 88% at 10 μ A
- Easy to Use – Addresses Popular Operations
 - 1.8V to 5.5V Input Range
 - Single Resistor-Adjustable V_{OUT} from 0.7V to 3.3V
 - Factory-Preprogrammed V_{OUT} from 0.5V to 5V
 - \pm 1.75% Output Voltage Accuracy
 - Up to 600mA Load Current Capability
- Protects System in Multiple Use Cases
 - Reverse-Current Blocking in Shutdown
 - Active Discharge Feature
- Reduces Size and Increases Reliability
 - -40°C to +85°C Temperature Range
 - 2.1mm x 2.6mm, 10-Lead eMGA Package

Key Applications

- Portable Space-Constrained Products
- Wearables
- Hearables
- Ultra-Low-Power IoT, NB IoT
- Bluetooth® LE Devices
- Single Li+ and Coin Cell Battery Products
- Wired, Wireless Products

Bluetooth is a registered trademark of Bluetooth SIG, Inc.

Simplified Application Diagram

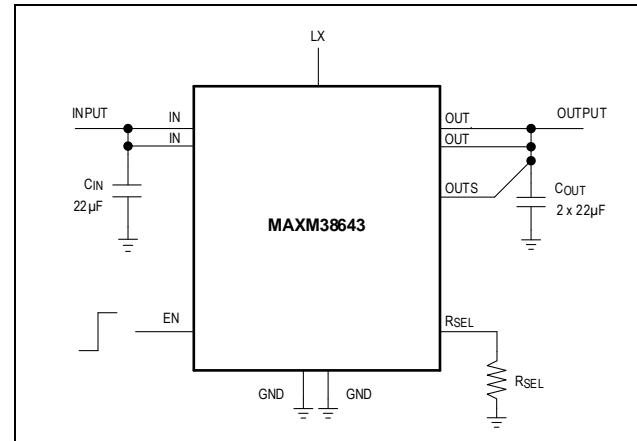

Pin Description

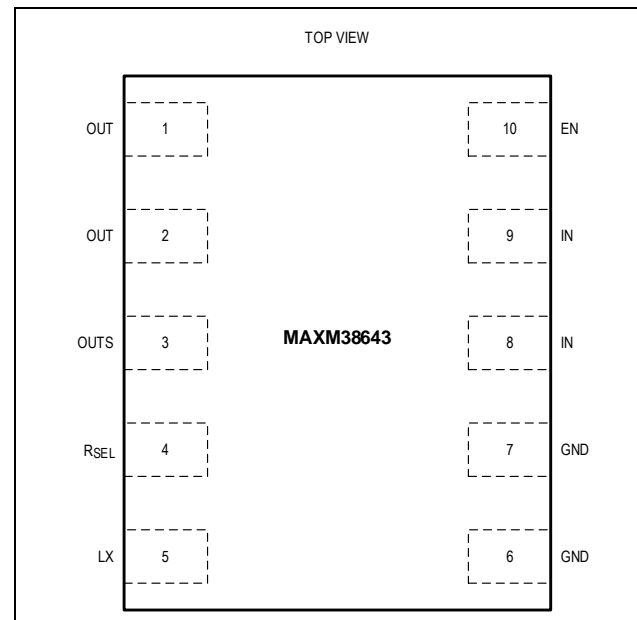

[Ordering Information](#) appears at end of data sheet.

Absolute Maximum Ratings

IN, EN, R _{SEL} , OUT, OUTS to GND	-0.3V to +6V	Operating Temperature Range.....	-40°C to +85°C
LX to GND	-0.3V to V _{IN} + 0.3V	Maximum Junction Temperature	+150°C
Continuous Power Dissipation (T _A = +70°C).....		Storage Temperature Range.....	-65°C to +150°C
eMGA Package (derate 9.72 mW/°C above 70°C)..	777.91mW	Lead Temperature (soldering, 10 seconds)	+300°C
		Soldering Temperature (reflow).....	+260°C

Note 1: LX pin has internal clamps to GND and IN. These diodes may be forward biased during switching transitions.

Stresses beyond those listed under "Absolute Maximum Ratings" may cause permanent damage to the device. These are stress ratings only, and functional operation of the device at these or any other conditions beyond those indicated in the operational sections of the specifications is not implied. Exposure to absolute maximum rating conditions for extended periods may affect device reliability.

Package Information

10 eMGA

Package Code	M102A2+2
Outline Number	21-100245*
Land Pattern Number	90-100084*
Thermal Resistance, Four-Layer Board:	
Junction to Ambient (θ _{JA})	102.84°C/W
Junction to Case (θ _{JC})	15.04°C/W

*For the latest package outline information and land patterns (footprints), go to www.maximintegrated.com/packages. Note that a "+", "#", or "-" in the package code indicates RoHS status only. Package drawings may show a different suffix character, but the drawing pertains to the package regardless of RoHS status.

Package thermal resistances were obtained using the method described in JEDEC specification JESD51-7, using a four-layer board. For detailed information on package thermal considerations, refer to www.maximintegrated.com/thermal-tutorial.

Electrical Characteristics

(V_{IN} = 3.3V, V_{OUT} = V_{OUTS} = 1.8V, T_A = -40°C to +85°C, C_{IN} = 1 x 22µF, C_{OUT} = 2 x 22µF, unless otherwise specified. See [Note 2](#).)

PARAMETER	SYMBOL	CONDITIONS	MIN	TYP	MAX	UNITS
Input Voltage Range	V _{IN}	Guaranteed by input undervoltage lockout and output accuracy	1.8		5.5	V
Input Undervoltage Lockout	V _{UVLO}	R _{SEL} > 60kΩ	V _{IN} rising	1.759	1.8	V
			V _{IN} falling	1.713		
			Hysteresis	50		mV
		R _{SEL} < 60kΩ	V _{IN} rising	2.624	2.7	V
			V _{IN} falling	2.499		
Hysteresis	125		mV			
Output Voltage Range	V _{OUT}	Guaranteed by output accuracy (Table 1)	0.7		3.3	V
Maximum Output Current	I _{OUT}	V _{IN} = 3.6V		600		mA
Output Accuracy	V _{OUT_ACC}	V _{OUTS} falling, when LX begins switching above 500kHz, V _{OUT} = V _{OUTS} = 0.7V to 3.3V, V _{IN} = 1.8V to 5.5V, V _{IN} > V _{OUTS} + 0.3V (Note 3)	-1.75		+1.75	%
DC Line Regulation	V _{OUT_LREG}	V _{OUT} = 1.8V, V _{IN} = 2.0V to 5.5V, I _{OUT} from 10mA to 500mA		±1.5		%
Efficiency	η	V _{IN} = 3.6V, V _{OUT} = 1.8V, I _{OUT} = 100µA		92		%
		V _{IN} = 3.6V, V _{OUT} = 1.8V, I _{OUT} = 100mA		94		
		V _{IN} = 5.0V, V _{OUT} = 1.8V, I _{OUT} = 100µA		90		

Tiny, 1.8V to 5.5V Input, 330nA I_Q, 600mA nanoPower Buck Module

[MAXM38643](#)

(V_{IN} = 3.3V, V_{OUT} = V_{OUTS} = 1.8V, T_A = -40°C to +85°C, C_{IN} = 1 x 22μF, C_{OUT} = 2 x 22μF, unless otherwise specified. See [Note 2](#).)

PARAMETER	SYMBOL	CONDITIONS	MIN	TYP	MAX	UNITS
		V _{IN} = 5.0V, V _{OUT} = 1.8V, I _{OUT} = 100mA		92		
		V _{IN} = 4.2V, V _{OUT} = 3.3V, I _{OUT} = 100μA		94		
		V _{IN} = 4.2V, V _{OUT} = 3.3V, I _{OUT} = 200mA		96		
Quiescent Supply Current into IN	I _{Q_IN}	V _{EN} = V _{IN} , not switching V _{OUTS} = 104% of target voltage, V _{OUTS_TARGET} = 2.5V, T _A = +25°C		330	660	nA
Quiescent Supply current into OUT	I _{Q_OUT}	V _{EN} = V _{IN} , not switching V _{OUTS} = 104% of target voltage, T _A = +25°C		5		nA
Shutdown Current into IN	I _{IN_SD}	V _{EN} = 0V, V _{OUT} = V _{OUTS} = V _{LX} = 0V, T _A = +25°C		0.001	0.1	μA
Soft-Start Time	t _{SS}	No load		250		μs
Inductor Peak Current Limit	I _{PEAK_LX}	V _{IN} from 2.0V to 5.5V	800	1000	1200	mA
Inductor Current Zero Crossing Threshold	I _{ZX_LX}	V _{OUT} = V _{OUTS} = 1.2V, percent of I _{PEAK_LX}		5		%
High-Side R _{DS(on)}	HS_ R _{DS(on)}	V _{IN} = 3.3V		95	150	mΩ
Low-Side R _{DS(on)}	LS_ R _{DS(on)}	V _{IN} = 3.3V		50	90	mΩ
Enable Voltage Threshold	V _{IH}	V _{EN} rising		0.841	1.2	V
	V _{IL}	V _{EN} falling	0.4	0.701		
Enable Input Leakage Current	I _{LK_EN}	V _{EN} = 5.5V, T _A = +25°C		0.004	1	μA
Active Discharge Resistance	R _{OUT_DIS}	V _{EN} = 0V	50	85.4	200	Ω
Required Select Resistor Accuracy	R _{SEL}	Use the nearest ±1% resistor from Table 1	-1		+1	%
Select Resistor Detection Time	t _{RSEL}	C _{RSEL} < 2pF	360	600	1200	μs
Thermal Shutdown Threshold	T _{SD}	T _A rising when output turns OFF		165		°C
		T _A falling when output turns ON		150		

Note 2: Limits over the specified operating temperature and supply voltage range are guaranteed by design and characterization, and production tested at room temperature only.

Note 3: Output accuracy in low-power mode (LPM) and does not include load, line, or ripple.

Typical Application Circuit

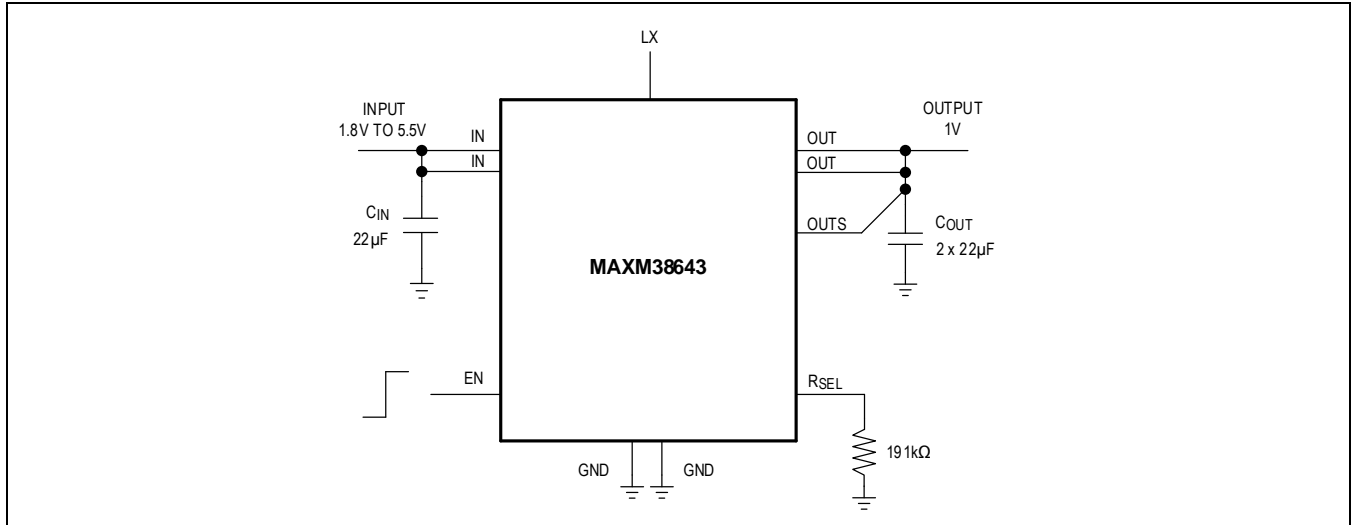

Typical Operating Characteristics

(MAXM38643AEMB+T, $V_{IN} = 3.6V$, $V_{OUT} = 1.8V$, $L = 1.5\mu H$ (integrated), $C_{IN} = 1 \times 22\mu F$, $C_{OUT} = 2 \times 22\mu F$, $T_A = +25^\circ C$ unless otherwise specified.)

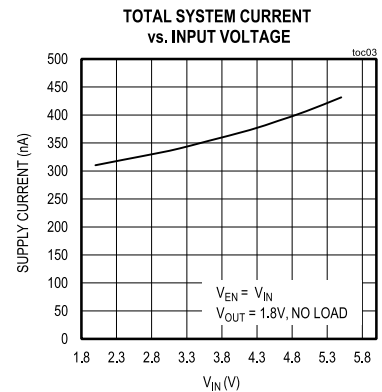
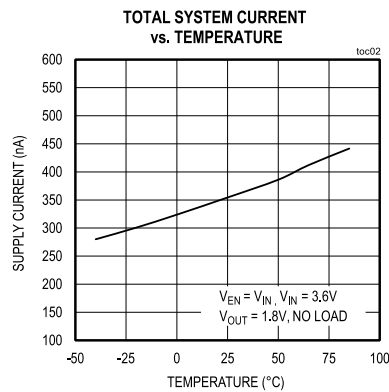
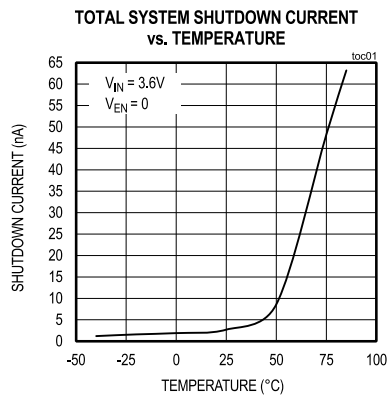

Tiny, 1.8V to 5.5V Input, 330nA I_Q, 600mA nanoPower Buck Module

MAXM38643

(MAXM38643AEMB+T, V_{IN} = 3.6V, V_{OUT} = 1.8V, L = 1.5μH (integrated), C_{IN} = 1 x 22μF, C_{OUT} = 2 x 22μF, T_A = +25°C unless otherwise specified.)

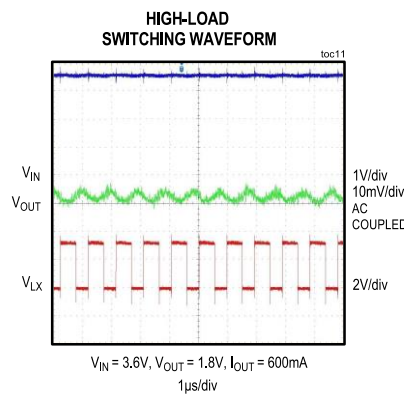
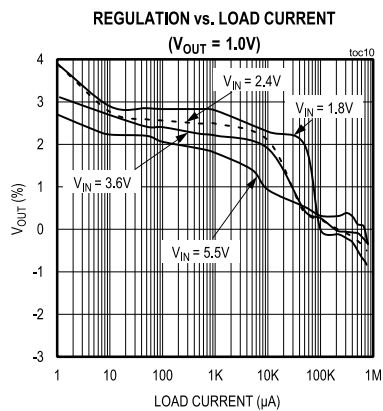
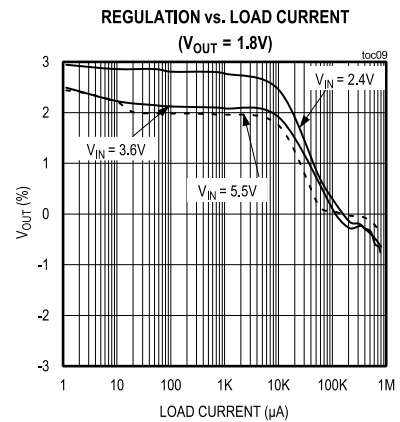
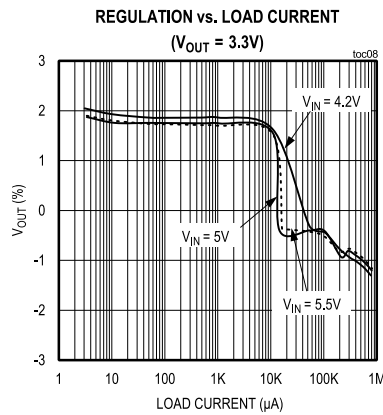
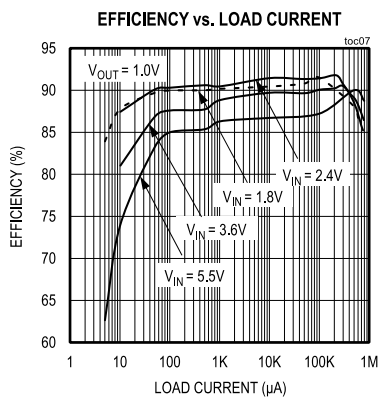
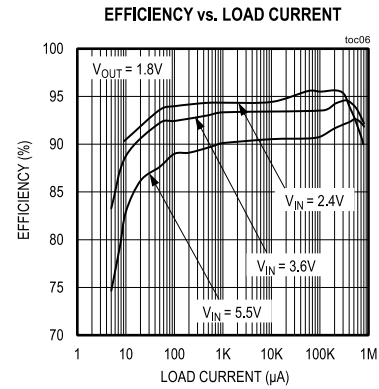
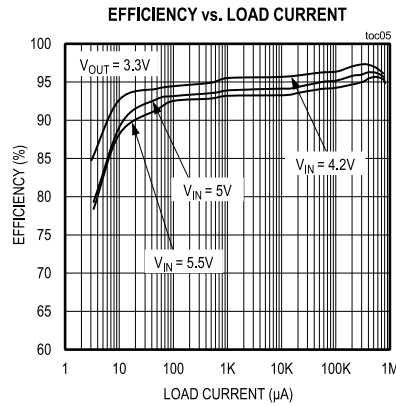
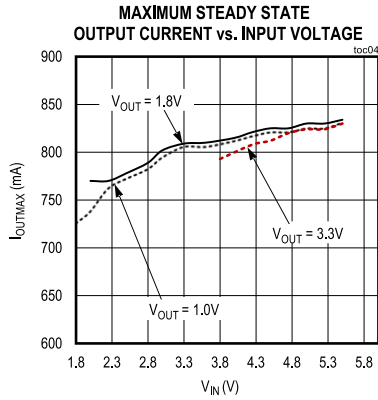

Tiny, 1.8V to 5.5V Input, 330nA I_Q, 600mA nanoPower Buck Module

[MAXM38643](#)

(MAXM38643AEMB+T, V_{IN} = 3.6V, V_{OUT} = 1.8V, L = 1.5μH (integrated), C_{IN} = 1 x 22μF, C_{OUT} = 2 x 22μF, T_A = +25°C unless otherwise specified.)

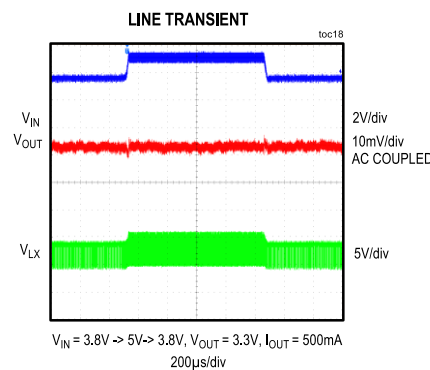
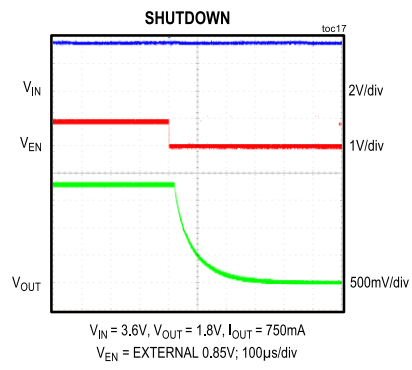
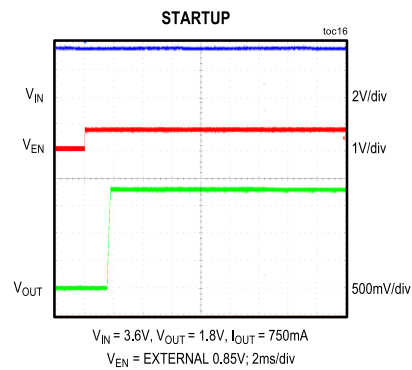
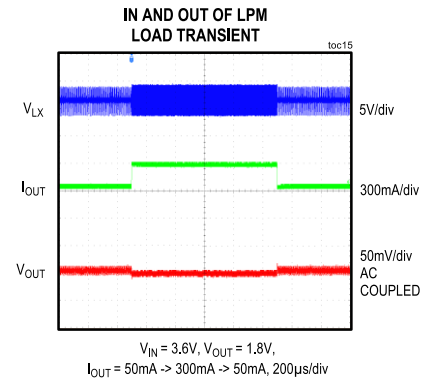
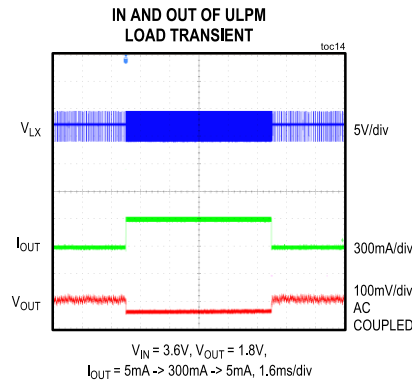
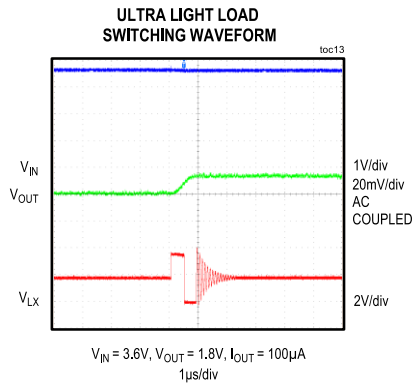

Pin Configuration

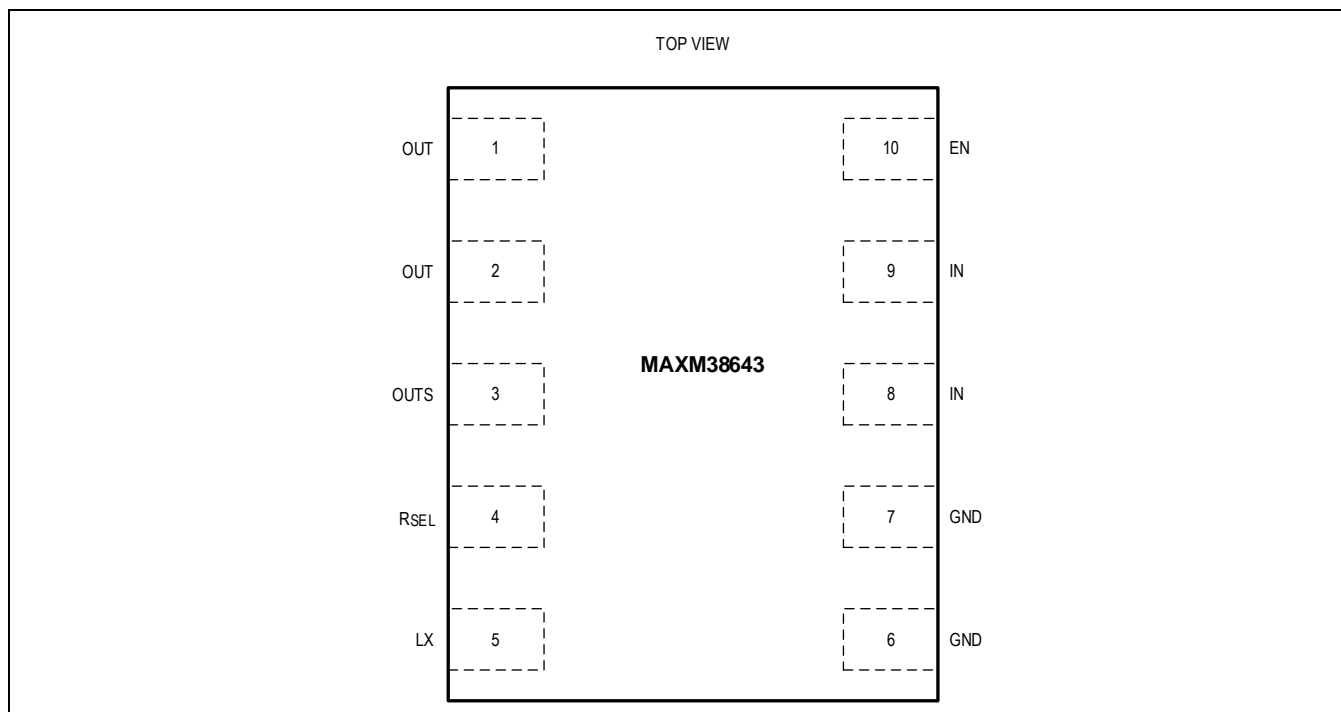

Pin Descriptions

PIN	NAME	FUNCTION
1, 2	OUT	Output Voltage Power Pins. Connect 2 x 22 μ F (2 in parallel, 22 μ F each) ceramic capacitors from OUT to GND.
3	OUTS	Output Voltage Sense Pin. Connect to the point where accurate regulation (output capacitor) is required.
4	R _{SEL}	Output Voltage Select Input. Connect a resistor from R _{SEL} to GND to program the output voltage and IN undervoltage lockout threshold based on the values in Table 1 .
5	LX	Switching Node Pin. Must be left floating; used by factory for testing only.
6, 7	GND	Ground Pins. Connect to the system ground.
8, 9	IN	Module Supply Input Pins. Connect a 22 μ F ceramic capacitor from IN to GND.
10	EN	Enable Input. Force this pin high to enable the buck module. Force this pin low to disable the part and enter shutdown.

Simplified Block Diagram

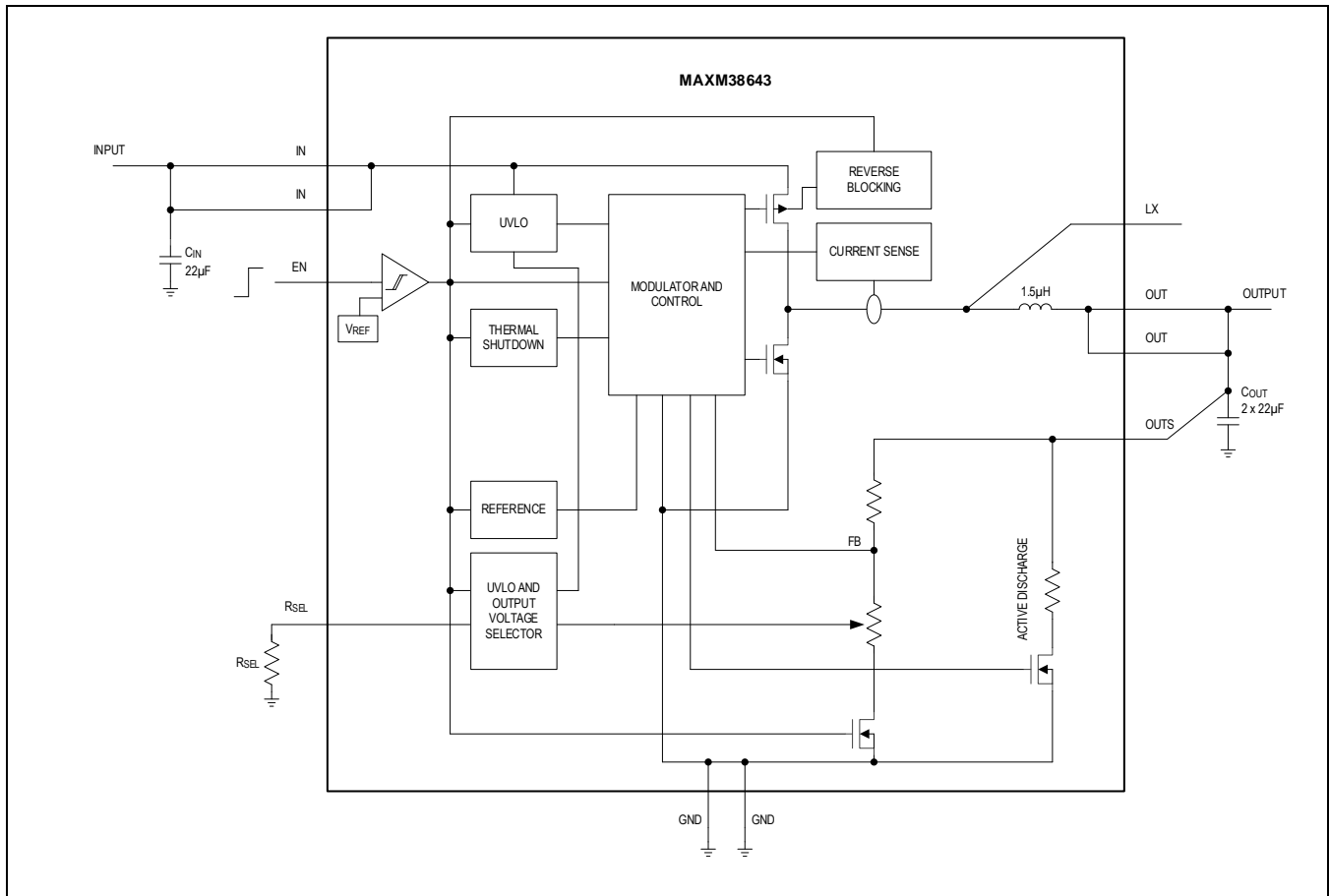

Detailed Description

The MAXM38643 is an ultra-low-I_Q (330nA) buck module that steps down input voltages in the range of 1.8V to 5.5V to a wide range of output voltages between 0.7V to 3.3V (using a single resistor at the R_{SEL} pin). The output voltage is programmable upon startup using a single external resistor from the R_{SEL} pin to GND. Factory-preprogrammed fixed output voltage versions from 0.5V to 5V are also available that do not use the R_{SEL} pin to set the output voltage. In this case, the R_{SEL} pin in the module is left floating.

The module offers robust performance features. To optimize efficiency and transient response across the load operation range, the module automatically switches between ultra-low-power mode (ULPM), low-power mode (LPM), and high-power mode (HPM) to better service the load, depending on the load current. The device overregulates in ULPM to improve efficiency and allow the output capacitor to handle the transient load currents. The device has 90% duty cycle limitation. An active discharge resistor pulls OUT to ground when the part is in shutdown.

Control Scheme

The output voltage is regulated higher while in ULPM. This reduces switching frequency, thus significantly improving system efficiency. In addition, operating marginally above the regulation threshold, the device has an excellent transient response when a large load transient event occurs.

Each switching cycle begins by turning the high-side power FET on. The inductor current ramps up to the inductor peak current-limit level at which point the on-time is terminated. Subsequently, the synchronous power FET turns on, and the inductor current ramps down until it reaches zero, at which point the switching ceases. During this single switching cycle,

a fixed amount of charge gets transferred to the output capacitor, thus increasing the output voltage. If the output voltage reaches the ULPM upper regulation threshold, the device will go into sleep mode to preserve energy. However, if one cycle is not enough for the output voltage to reach the upper threshold, as it may be the case at higher load levels, the device will burst switching pulses together every 10μs until the threshold is reached. The upper regulation threshold in ULPM is 2.7% (nominal) above the regulation target in LPM.

Once the output voltage exceeds the upper ULPM regulation level, the device will go into a sleep mode, consuming very low quiescent current. The load current slowly discharges the output capacitor, causing the output voltage to ramp down. The MAXM38643 wakes up to resume switching only when the output voltage falls below the upper regulation threshold. In ULPM, the device regulates output voltage while consuming only 330nA of quiescent current.

The MAXM38643 transitions to LPM once the load current is high enough that it forces the device to switch faster than every 10μs to maintain regulation.

Once in the LPM, the device regulates the output voltage to the lower regulation, which is the output voltage target level in LPM. Again, each switching cycle begins by turning the high-side power FET on. The inductor current ramps up to the inductor peak current limit level, at which point the on-time is terminated. Subsequently, the synchronous power FET turns on and the inductor current ramps down until the inductor current reaches zero. During this switching cycle, a quantity of charge gets transferred to the output capacitor, thus increasing the output voltage. The load current discharges the output capacitor to the lower regulation threshold, at which point a new switching cycle is initiated and the process repeats.

When the output current level rises to the levels where the inductor current ripple does not reach the zero-ampere level, the module transitions to high-power mode (HPM) or continuous-conduction mode (CCM). In this mode, the inductor current ripple is smaller than in ULPM and LPM to support higher load levels. This also assures a smooth transition between the modes.

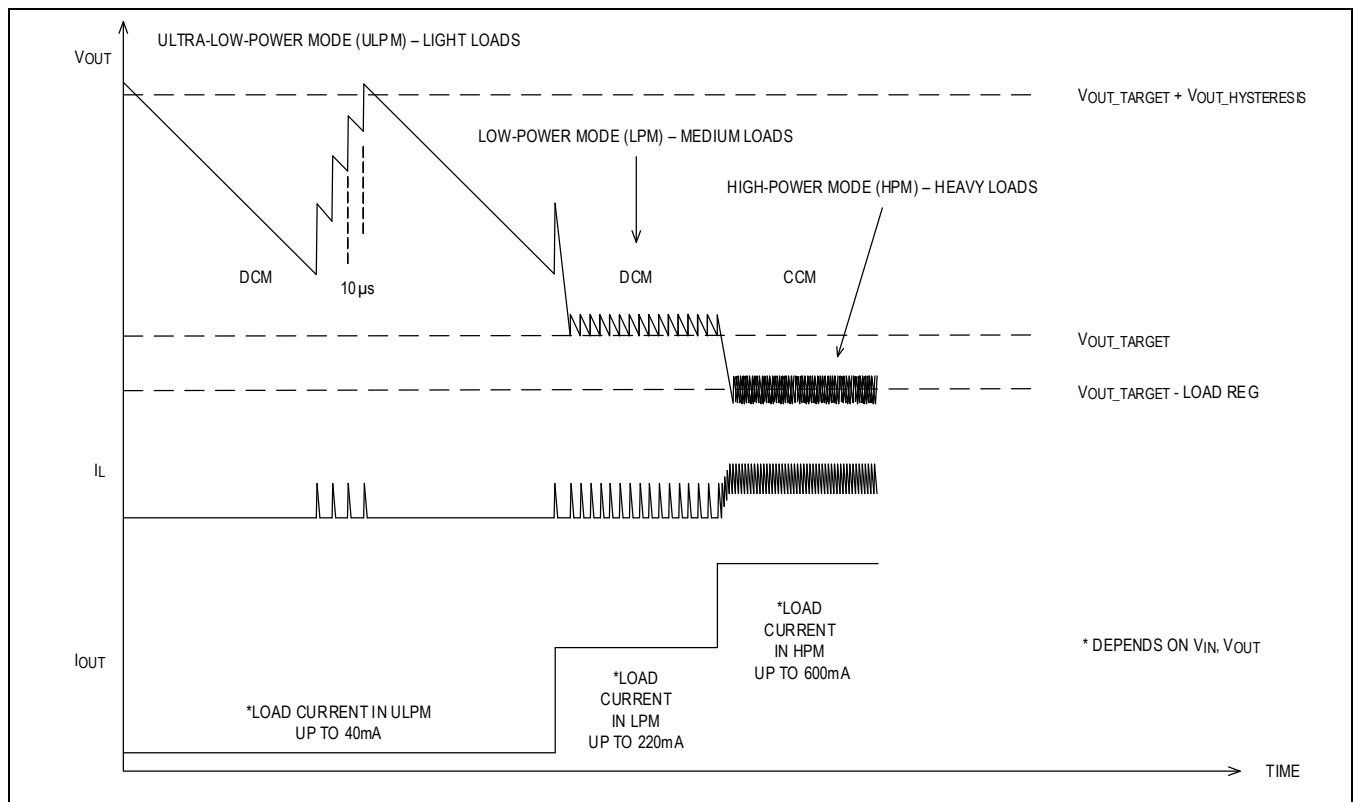

Figure 1. Mode Transitions

Integrated Inductor

A 1.5µH integrated inductor is used in the MAXM38643 buck module. The chosen inductor (Murata part# DFE201610E-1R5M=P2), offers optimized stability across the device operation range.

Voltage Configuration

The MAXM38643 includes an R_{SEL} pin to configure the output voltage and input UVLO threshold on startup. Resistors with a tolerance of 1% (or better) should be chosen with the nominal values specified in [Table 1](#).

Table 1. MAXM38643A R_{SEL} Selection Table

TARGET OUTPUT VOLTAGE (V)	R _{SEL} (kΩ)	INPUT UVLO THRESHOLD, RISING (V)
2.5	OPEN	1.75
2.0	909	1.75
1.8	768	1.75
1.5	634	1.75
1.3	536	1.75
1.25	453	1.75
1.2	383	1.75
1.15	324	1.75
1.1	267	1.75
1.05	226	1.75
1.0	191	1.75
0.95	162	1.75
0.9	133	1.75
0.85	113	1.75
0.8	95.3	1.75
0.75	80.6	1.75
0.7	66.5	1.75
3.3	56.2	2.6
3.0	47.5	2.6
2.8	40.2	2.6
2.75	34	2.6
2.5	28	2.6
2.0	23.7	2.6
1.8	20	2.6
1.5	16.9	2.6
1.25	14	2.6
1.2	11.8	2.6
1.15	10	2.6
1.1	8.45	2.6
1.0	7.15	2.6
0.95	5.9	2.6
0.9	4.99	2.6
0.8	SHORT TO GND	2.6

Fixed Output Voltage Versions – Factory Preprogrammed

Note that MAXM38643 can also be ordered with a factory-preprogrammed fixed output voltage (no R_{SEL} programming). In this configuration, the R_{SEL} resistor is not required, and the R_{SEL} pin shall be left floating. Contact a Maxim Integrated Representative for more information and availability for select preprogrammed V_{OUT}.

Applications Information

Input Capacitor

The input capacitor (C_{IN}) reduces the peak current drawn from battery or input power source and reduces the switching noise in the module. The impedance of C_{IN} at the switching frequency should be very low. Ceramic capacitors are

recommended for their small size and low ESR. For most applications, use a 22 μ F ceramic capacitor with X5R or X7R temperature characteristics. When operating at a V_{IN} close to the UVLO, more input capacitance may be required to keep the input voltage ripple from tripping the UVLO protection.

Output Capacitor

The output capacitor (C_{OUT}) is required to keep the output voltage ripple small and to ensure loop stability. C_{OUT} must have low impedance at the switching frequency. Ceramic capacitors are recommended due to their small size and low ESR. Make sure the capacitor does not degrade its capacitance significantly over temperature and DC bias. Capacitors with X5R or X7R temperature characteristics typically perform well. It is recommended to have 30 μ F of effective capacitance at C_{OUT}.

Enabling Device

The device has a dedicated EN pin. This pin can be driven by a digital signal. It is recommended that the digital signal enables the device after V_{IN} crosses the UVLO threshold. If the enable feature is unused, short the EN pin to IN. Connect the EN pin to the IN pin or drive it to more than 0.85V nominal (V_{IH}) for normal operation. When the EN pin goes below 0.7V nominal (V_{IL}), the MAXM38643 enters shutdown mode where the output gets pulled to ground through an 85 Ω active discharge circuit. In addition, the body diode of the high-side FET is biased so that it prohibits any reverse-current flow back to the input. The device consumes 1nA (I_{IN_SD}) of current from IN while in shutdown mode.

The device is designed to be powered by fast V_{IN} slew rates. In applications where EN is tied to IN and where V_{IN} slew rates are slower than 5V/ms, users must delay enabling the device after V_{IN} crosses the UVLO threshold. This can be done using a simple RC circuit, as shown in [Figure 2](#).

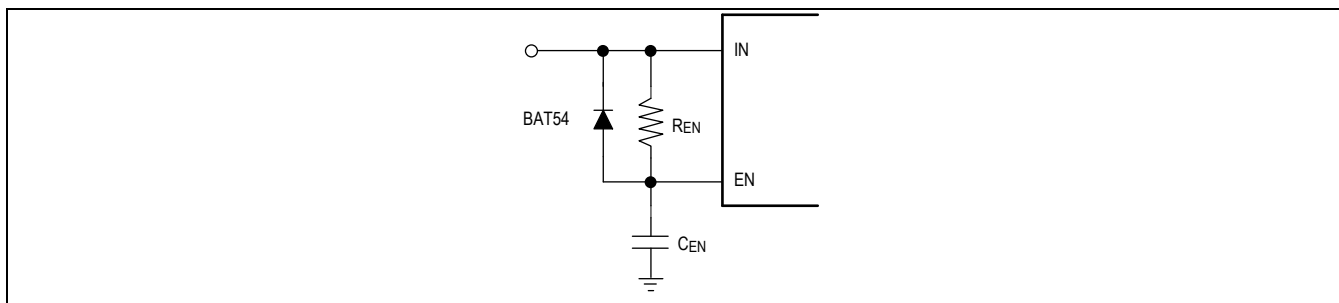

Figure 2. Simple RC Circuit

PCB Layout and Routing

High switching frequencies and large peak currents make PCB layout a very important part of the buck converter design. Good design minimizes excessive electromagnetic interference (EMI) in the feedback path and voltage gradients in the ground plane to avoid instability and regulation errors. The input capacitor (C_{IN}) should be placed as close as possible to the module IN and GND pins. Connect the input capacitor (C_{IN}) and output capacitor (C_{OUT}) grounds together through a short, wide connection. Connect the module GND pins directly to the ground of C_{IN}. The OUTS pin should be connected to the output capacitor, and this trace should be routed away from the main power path between C_{IN} and C_{OUT}. Refer to the MAXM38643 evaluation kit for an example of a PCB layout and routing scheme.

Ordering Information

PART NUMBER	TEMPERATURE RANGE	PIN PACKAGE	FEATURES
MAXM38643AEMB+T	-40°C to +85°C	10-lead eMGA package (2.1mm x 2.6mm, 0.5mm pitch)	0.7V to 3.3V resistor-selectable output voltage using R _{SEL} pin
MAXM38643BEMB+T*	-40°C to +85°C	10-lead eMGA package (2.1mm x 2.6mm, 0.5mm pitch)	0.5V to 5V preprogrammed output voltage

+ Denotes a lead (Pb)-free/RoHS-compliant package.

T = tape-and-reel

*Contact factory/Maxim Sales Representative for availability.

Revision History

REVISION NUMBER	REVISION DATE	DESCRIPTION	PAGES CHANGED
0	7/21	Initial release	—

For pricing, delivery, and ordering information, please visit Maxim Integrated's online storefront at <https://www.maximintegrated.com/en/storefront/storefront.html>.

Maxim Integrated cannot assume responsibility for use of any circuitry other than circuitry entirely embodied in a Maxim Integrated product. No circuit patent licenses are implied. Maxim Integrated reserves the right to change the circuitry and specifications without notice at any time. The parametric values (min and max limits) shown in the Electrical Characteristics table are guaranteed. Other parametric values quoted in this data sheet are provided for guidance.

Looking for pricing, stock, or lifecycle information?

Click below to explore more details on WIN SOURCE:

 View [MAXM38643AEMB+](#) on WIN SOURCE

 [Maxim Integrated](#) Information

Optimize Your Supply Chain with WIN SOURCE Solutions

-  Global Sourcing Solution
-  Obsolete Management
-  Cost Control Management
-  Shortage Management
-  Alternative Solution
-  Excess Inventory Management