



THE DATASHEET OF E35SE24006PDPG



FEATURES

Electrical

- Efficiency up to 92.2%
- Fully protected: Input UVLO, Output OVP, OCP and OTP
- Multiple packaging (Open Frame, With Baseplate, With Baseplate and Potting)
- Wide output voltage trim range
- Monotonic and pre-biased startup
- No minimum load required
- Operating Baseplate Temperature: -40°C ~ +105°C
- Up to 3000Vdc isolation
- Working altitude up to 5500 m

Safety & Certificate

- IEC/EN/UL/CSA 60950-1, 62368-1
- Compliance to EN50155
- Compliance to EN45545-2
- ISO 9001, TL 9000, ISO 14001, QS 9000, OHSAS18001 certified manufacturing facility

Soldering Method

- Wave soldering
- Hand soldering



Input voltage: 9~60Vdc
 Single output: 5V, 12V, 24V, 48V
 Output power: 150W @24Vin, 48Vin
 120W @12Vin

Recommended Part Number

Model Name	Input	Output		Eff. @ 100% Load	Others
E35SE05030PDPG	9V~60V	5V	30A/24A	92.2% @ 24Vin	Positive on/off With Baseplate and Potting
E35SE12013PDPG		12V	13A/10A	91.0% @ 24Vin	
E35SE24006PDPG		24V	6A/5A	92.2% @ 24Vin	
E35SE48003PDPG		48V	3A/2.5A	91.2% @ 24Vin	

Part Numbering System

E	35	S	E	xxxxx	P	D	P	G
Form Factor	Input Voltage	Number Of Outputs	Product Series	Output Voltage & Current	ON/OFF Logic	Pin Length	Operating Ambient Temperature	Option Code
E - 1/8 Brick	35 - 9~60V	S - Single	E - Series Number	05030 - 5V & 30A 12013 - 12V & 13A 24006 - 24V & 6A 48003 - 48V & 3A	P - Positive N - Negative	D - 0.24" T - 0.22" R - 0.17"	P - -40~85°C	A - Open Frame H - With Baseplate G - With Baseplate and Potting

All of the modules are intended for wave soldering assembly onto system boards; please do not subject the modules through reflow temperature profile.

Attribute		Model	E35SE05030	E35SE12013	E35SE24006	E35SE48003
INPUT	Voltage	continuous	9~60Vdc			
		transient	80V/100ms			
	Current	@9Vin, full load, max.	17.5A	17.5A	17.5A	17.5A
		@24Vin, no load, typ.	190mA	300mA	160mA	220mA
		@Enable off, typ.	3 mA			
		Inrush(I ² t), typ.	1 A ² S			
	Efficiency	Reflected-ripple, typ.	52mA	40mA	72mA	110mA
24Vin, 100% load, typ.		92.2%	91.0%	92.2%	91.2%	
24Vin, 60% load, typ.		92.3%	90.4%	92.9%	92.2%	
48Vin, 100% load, typ.		91.3%	90.1%	91.1%	91.2%	
	48Vin, 60% load, typ.	91.7%	88.2%	91.6%	90.2%	
OUTPUT	Voltage Setting		5V±1%	12V±1%	24V±1%	48V±1%
	Current Rating	24~60Vin	0~30A	0~13A	0~6A	0~3A
		9~24Vin	0~24A	0~10A	0~5A	0~2.5A
		18~24Vin ^{*Note 2, max.}	30A	13A	6A	3A
	Voltage adjustment range ^{*Note 3}		-20%~+20%			
	Ripple & Noise(Peak-Peak) @10%~30% load ^{*Note 4, max.}		200mV	500mV	500mV	500mV
	Ripple & Noise(Peak-Peak) @ full load ^{*Note 4, typ.}		20mV	85mV	230mV	200mV
	Output Regulation	Line	0.2% max			
		Load	0.2% max			
		Temperature	1% max			
	Start-up Time ^{*Note 5}	Delay from input, typ.	250ms	250ms	250ms	250ms
		Delay from on/off, typ.	250ms	250ms	250ms	250ms
		Rise time, typ.	6ms	35ms	35ms	25ms
	Transient response ^{*Note 6}	Voltage deviation	3% Vo,nom			
Response time, typ.		200uS				
Output capacitance		0~10000uF	0~5200uF	0~2400uF	0~1200uF	
PROTECTION	Output Over Current (hiccup)		110%~180% Io,max			
	Output Over Voltage (hiccup)		120%~150% Vo,nom			
	Input UVLO	On threshold	8.5V (8~9V)			
		Off threshold	7.5V (7~8V)			
		Hysteresis, typ.	1V			
OTP shutdown	NTC resistor ^{*Note 7}	128°C				
ISOLATION	Voltage, Input to Output		3000Vdc max			
	Resistance (at 500Vdc)		10 MΩ min			
	Capacitance		500pF			
ENVIRONMENT	Operating ambient temperature		-40~85°C with de-rating			
	Operating baseplate temperature		-40~105°C with de-rating			
	Storage temperature		-55~125°C			
	Operating Humidity		Max 95%			
Enable control	Logic low		-0.7~0.8V			
	Logic high		2.4~5.0V			
	Current (Von/off=0V), max.		1.5mA max			
Others	Fixed Switching Frequency		380 kHz	380 kHz	330kHz	290 kHz
	MTBF (80% load,300LFM,25°C)		≥1.4 Mhours			
	Weight	Open Frame	27.9g			
		With Baseplate	33.5g			
With Baseplate and Potting		50.5g				

Notes

All specifications valid at 24Vin,100% Rated load and 25°C ambient, unless otherwise indicated.

*2. Maximum output power is 150W at 18~24Vin which is guaranteed by design.

*3. Maximum output power & current of the module should not over rated power & current.

*4. Ripple & Noise measurement bandwidth is 0-20MHz, Vin=24V, Cout=Refer ripple waveform for detailed value information.

*5. "Delay from input": from Vin reaching turn-on threshold to 10% Vout (pre-applied enable); "Delay from on/off": From enable to 10% Vout (pre-applied Vin); "Rise time" From 10% to 90% Vout.

*6. Load transient test condition: 24Vin, 10uF Low ESR Polymer & 1uF ceramic load cap & electrolytic capacitor, 50%~75% Load step, 0.1A/us.

*7. Thermal test condition: 24Vin, 80% load, 200LFM, Airflow from Vin+ to Vin-.

Mechanical Drawing

Open Frame

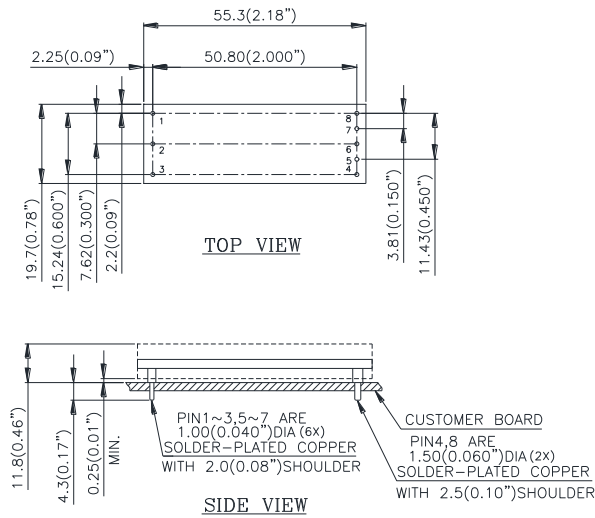

NOTES:
 DIMENSIONS ARE IN MILLIMETERS AND (INCHES)
 TOLERANCES: X.Xmm±0.5mm(X.XX in.±0.02 in.)
 X.XXmm±0.25mm(X.XXX in.±0.010 in.)

With Baseplate

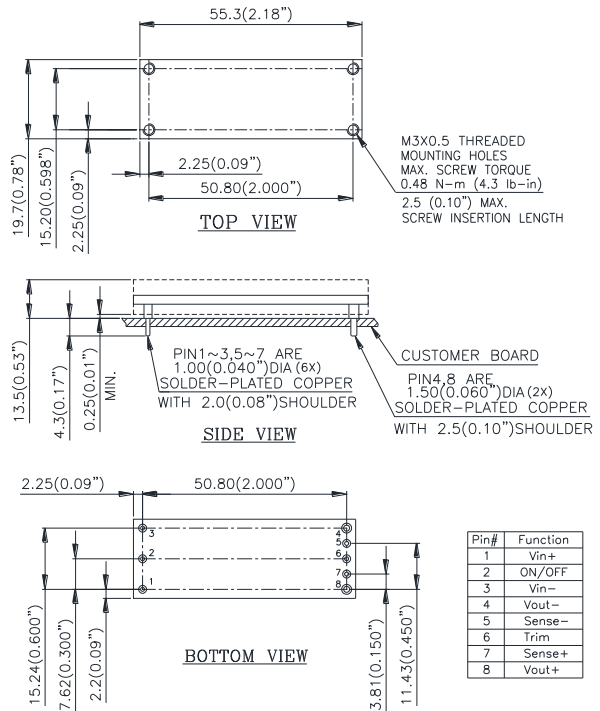

With Baseplate and Potting

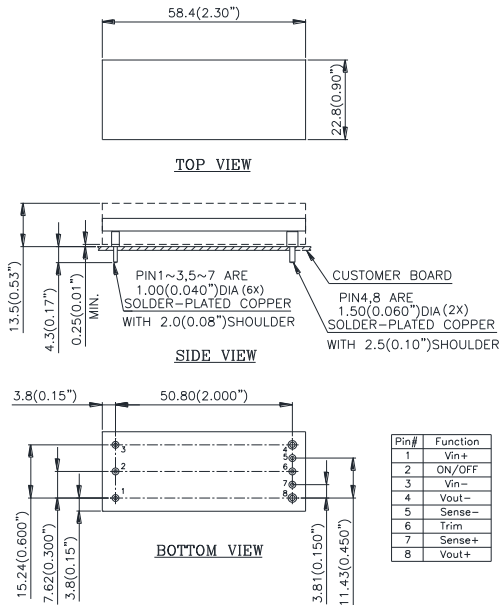

NOTES:
 DIMENSIONS ARE IN MILLIMETERS AND (INCHES)
 TOLERANCES: X.Xmm±0.5mm(X.XX in.±0.02 in.)
 X.XXmm±0.25mm(X.XXX in.±0.010 in.)

Note: All pins are copper alloy with matte Tin (Pb free) plated over Nickel under plating.

Recommended Pad Layout

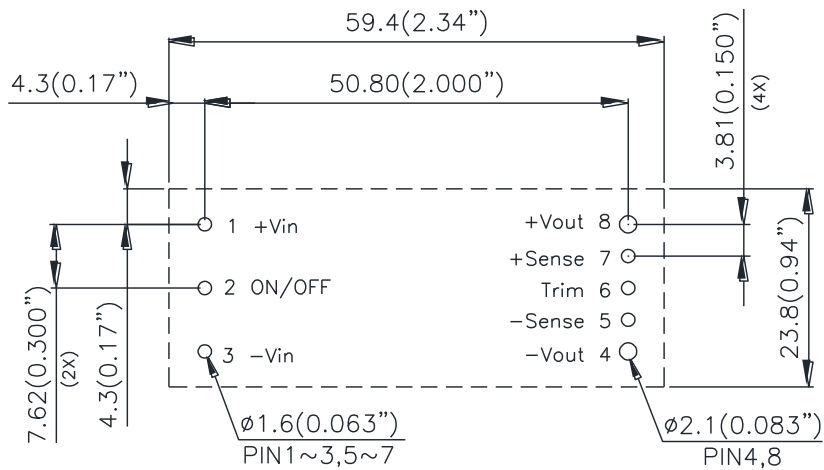

NOTES:
 DIMENSIONS ARE IN MILLIMETERS AND (INCHES)
 TOLERANCES: X.Xmm±0.5mm(X.XX in.±0.02 in.)
 X.XXmm±0.25mm(X.XXX in.±0.010 in.)

Typical EMI Filter Circuit for EN55032 Class A Conducted Emission

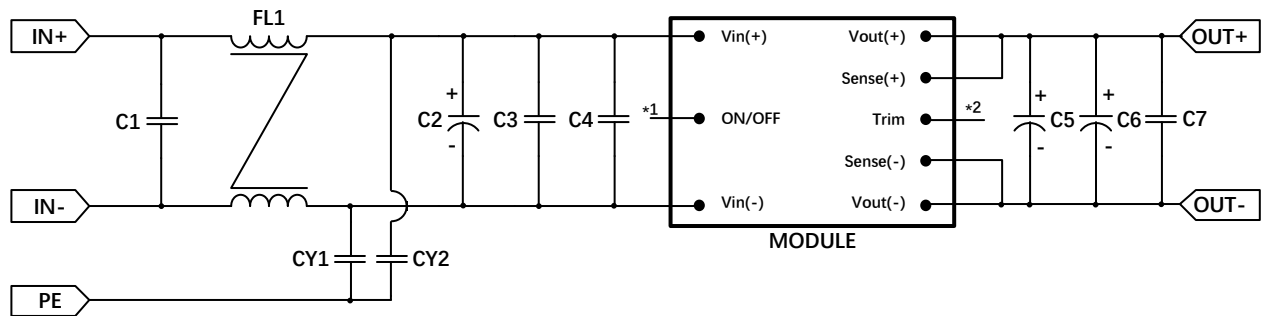

* Compliance to EN50155

*1,*2: Please refer to page12 for the On/Off (pin2) and Trim (pin6) implementation.

Location	Vendor P/N	Description	Qty	Vendor	Purpose
C1	D3D2H505KB00352	500V 5uF K S27.5 32*11*20	2	FARATRONIC	EMC
FL1	PH9455.155NL	19A 1.62mH NPB SRF 10MHz	1	Pulse	EMC
CY1	CS12-F2GA472MYNSAC	250VAC 4700pF M F VI7.5	5	TDK	EMC
CY2	CS12-F2GA472MYNSAC	250VAC 4700pF M F VI7.5	5	TDK	EMC
C2	100PX220MGA12.5X20	100V 220uF M 12.5*20	1	RUBYCON	EMC
C3	C1210X475K101TX	100V 4.7uF K X7R 1210	2	HOLY STONE	EMC
C4	GRM32NR72A104KA01L	100V 0.1uF K X7R 1210	2	MURATA	EMC
C5	100ZLH33MEFCTA8X11.5	100V 33uF M 8*11.5	1	RUBYCON	EMC
C6	ZGD2AM100E11A	100V 10uF M 6.3*11	1	LUMINOUS	EMC
C7	GRM31CR72A105KA01L	100V 1uF K X7R 1206	1	MURATA	EMC

*The components for EMC purpose can be deleted if no EMC requirement.

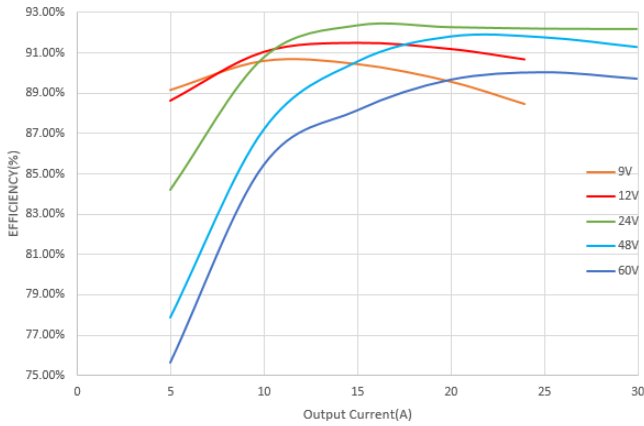

Efficiency vs. load current for various input voltage at 25°C.

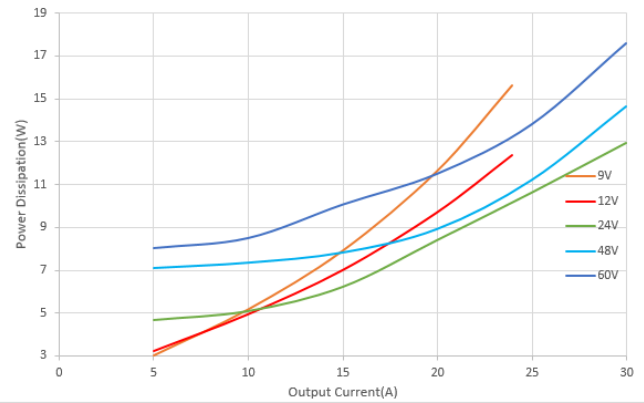

Power dissipation vs. load current at 25°C.

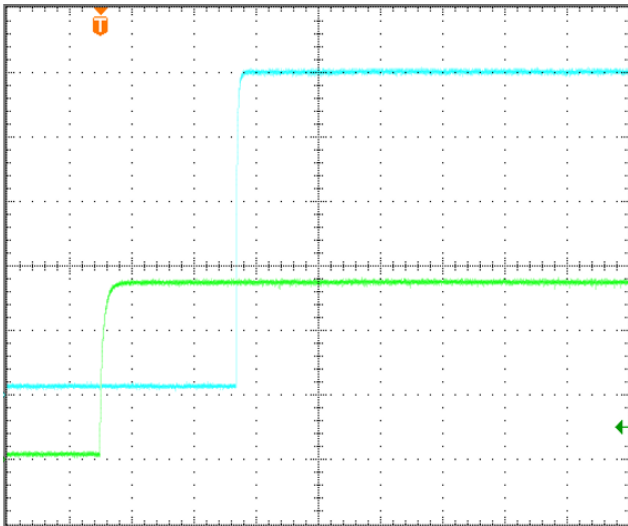

Turn-on transient at full load current (100ms/div).
Top Trace: Vout, 1V/div; Bottom Trace: ON/OFF input, 2V/div.

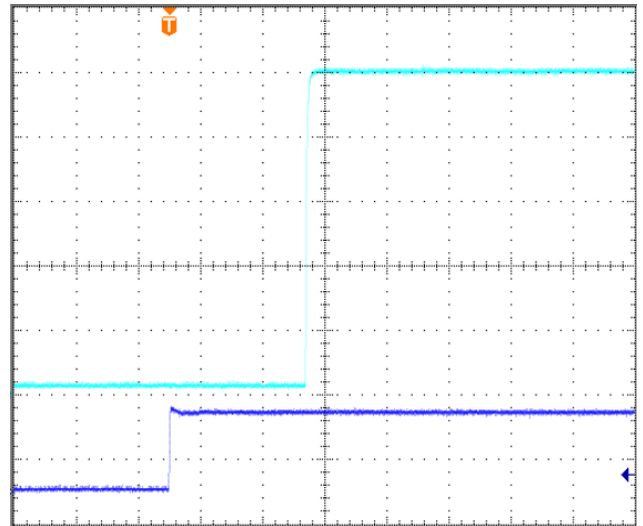

Turn-on transient at full load current (100ms/div).
Top Trace: Vout, 1V/div; Bottom Trace: input voltage, 10V/div.

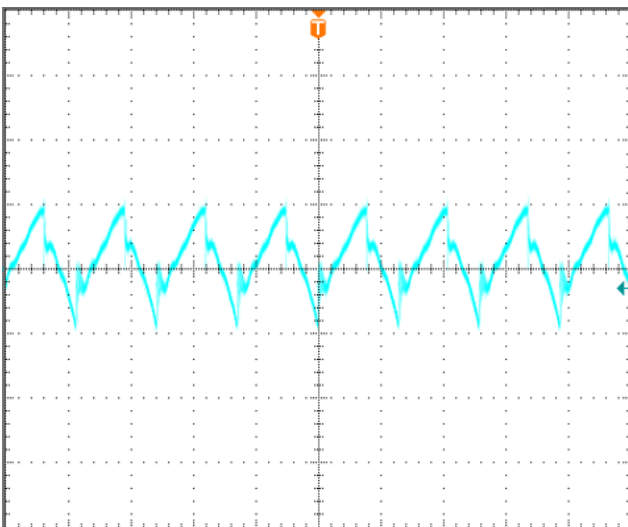

Output voltage ripple at nominal input voltage and max load current (10mV/div, 2us/div)
Load cap: 10μF Low ESR Polymer; 1μF ceramic capacitor
270μF*2 Low ESR Polymer;
Bandwidth: 20MHz

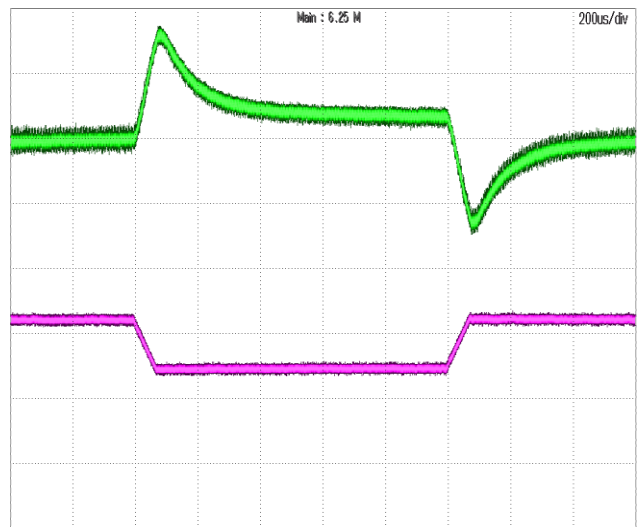

Top trace Vout dynamic AC Value, 200mV/div, 200us/div
Load cap: 10μF Low ESR Polymer; 1μF ceramic capacitor
270μF*2 Low ESR Polymer;
Bottom Trace :load 50% to 75% of rated Iout 10A/div,
Bandwidth: 20MHz

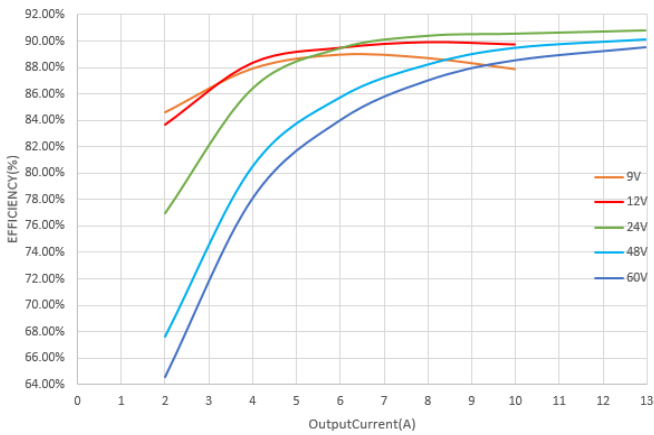

Efficiency vs. load current for various input voltage at 25°C.

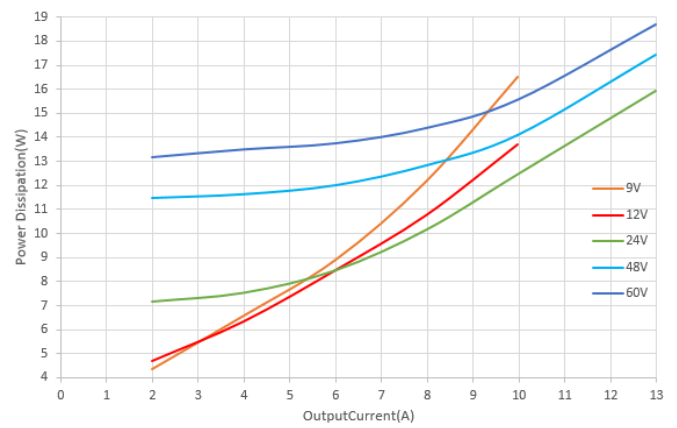

Power dissipation vs. load current at 25°C.

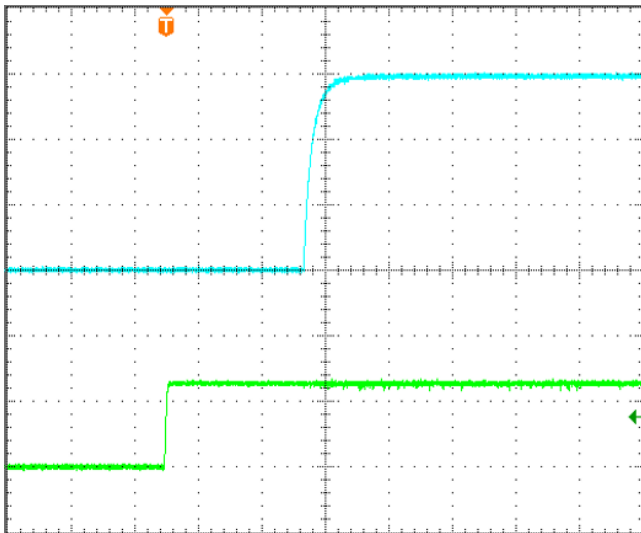

Turn-on transient at full load current (100ms/div).
Top Trace: Vout, 4V/div; Bottom Trace: ON/OFF input, 2V/div.

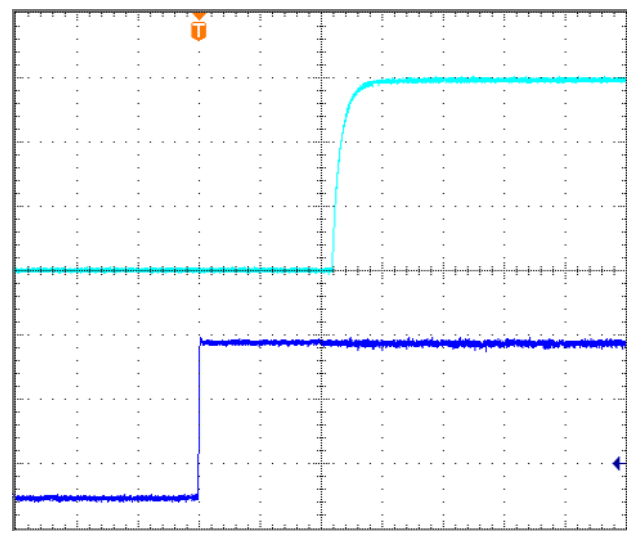

Turn-on transient at full load current (100ms/div).
Top Trace: Vout, 4V/div; Bottom Trace: input voltage, 10V/div.

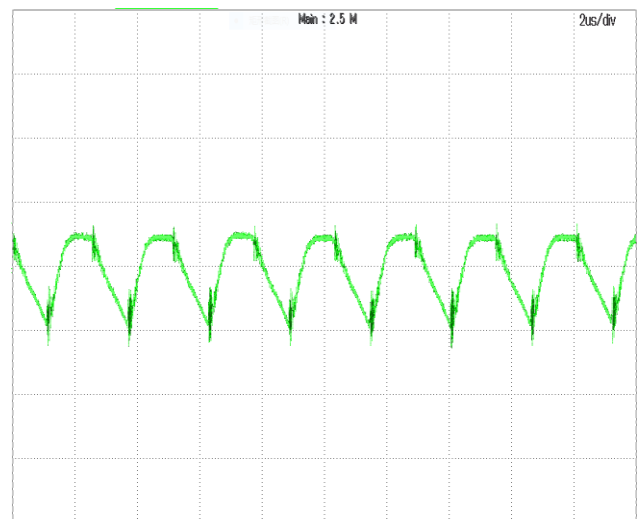

Output voltage ripple at nominal input voltage and max load current (50mV/div, 2us/div)
Load cap: 33 μ F*5, Low ESR Polymer; 10 μ F, Low ESR Polymer;
1 μ F ceramic capacitor
Bandwidth: 20MHz

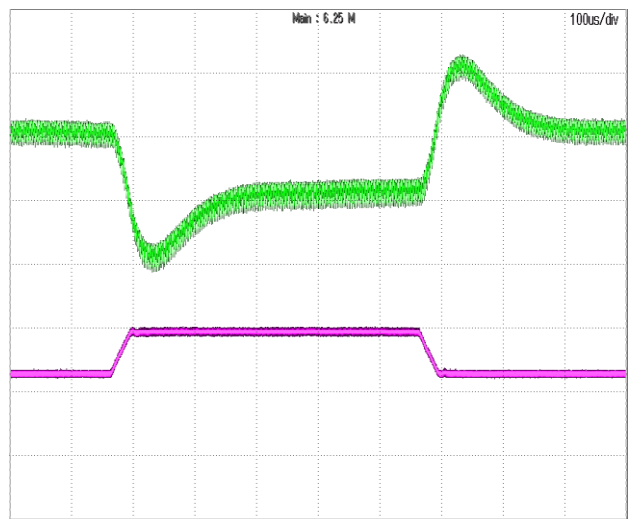

Top trace Vout dynamic AC value, 200mV/div, 100us/div
Load cap: 33 μ F*5, Low ESR Polymer; 10 μ F Low ESR Polymer,
1 μ F ceramic capacitor
Bandwidth: 20MHz

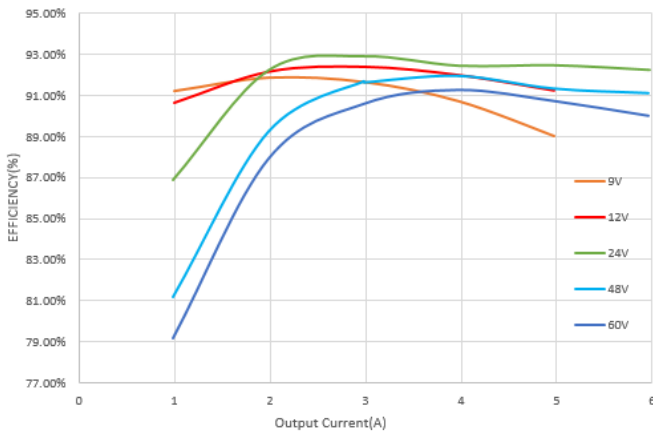

Efficiency vs. load current for various input voltage at 25°C.

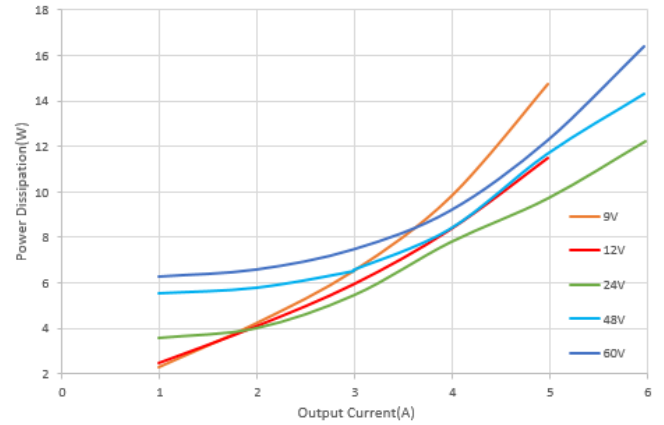

Power dissipation vs. load current at 25°C.

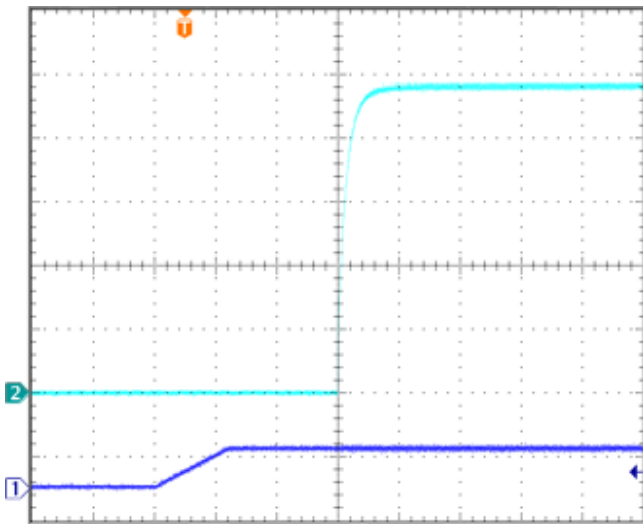

Turn-on transient at full load current (50ms/div).
Top Trace: Vout, 10V/div; Bottom Trace: ON/OFF input, 2V/div.

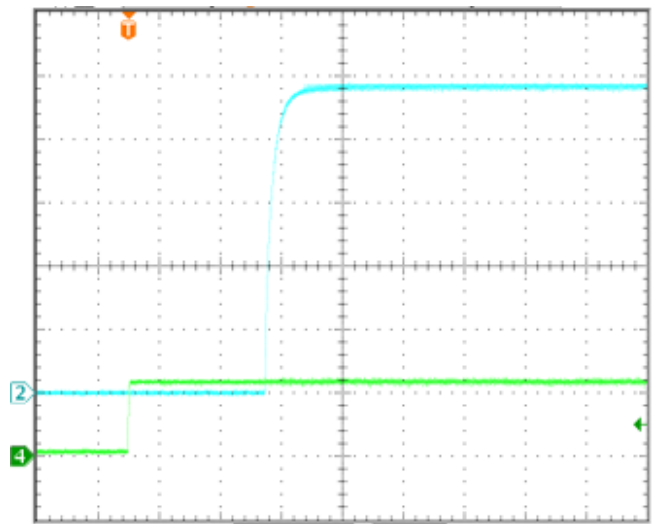

Turn-on transient at full load current (50ms/div).
Top Trace: Vout, 10V/div; Bottom Trace: input voltage, 10V/div.

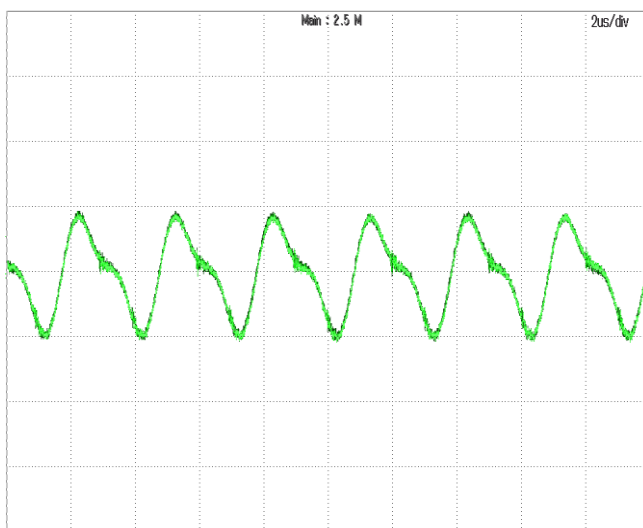

Output voltage ripple at nominal input voltage and max load current (100mV/div, 2us/div)
Load Cap: 33μF Low ESR Polymer; 10μF Low ESR Polymer; 1μF Ceramic capacitor
Bandwidth: 20MHz

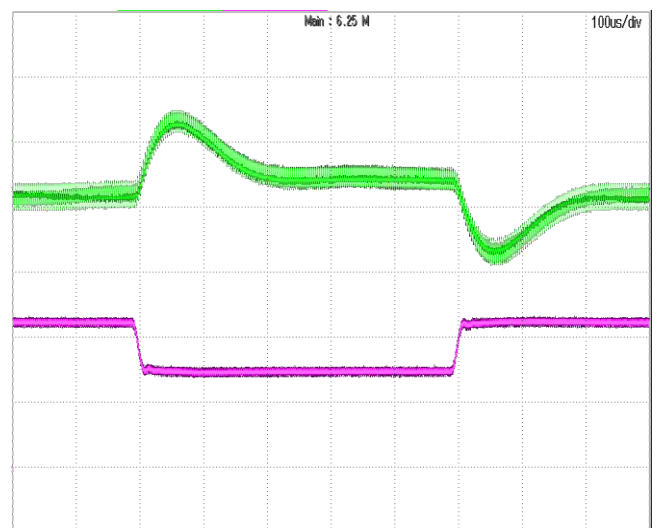

Top trace Vout dynamic AC value, 500mV/div, 200us/div
Load Cap: 33μF Low ESR Polymer; 10μF Low ESR Polymer; 1μF Ceramic capacitor
Bottom Trace, load 50% to 70% of rated Io, 2A/div, ,
Bandwidth: 20MHz

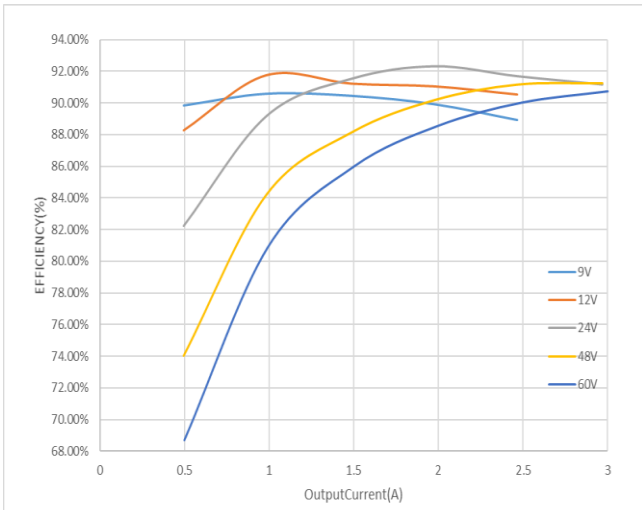

Efficiency vs. load current for various input voltage at 25°C.

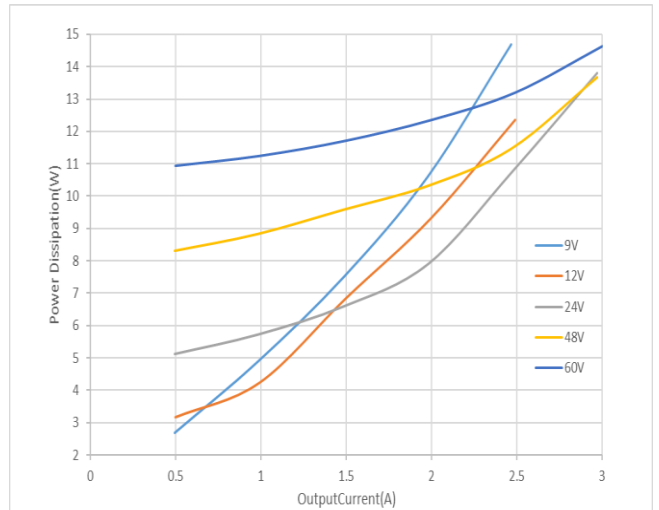

Power dissipation vs. load current at 25°C.

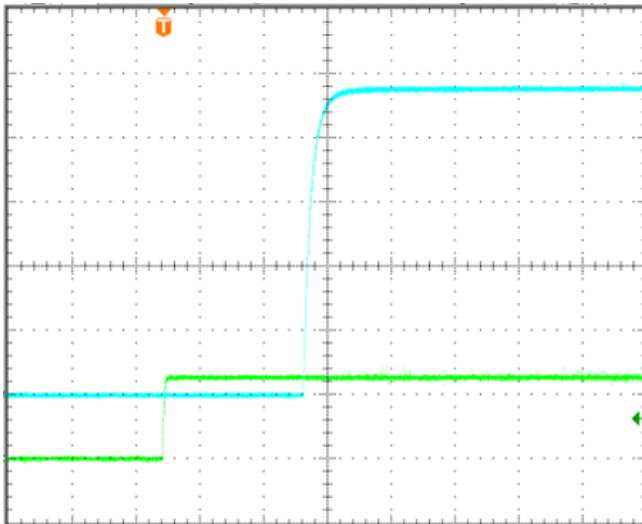

Turn-on transient at full load current (100ms/div).
Top Trace: Vout, 10V/div; Bottom Trace: ON/OFF input, 2V/div.

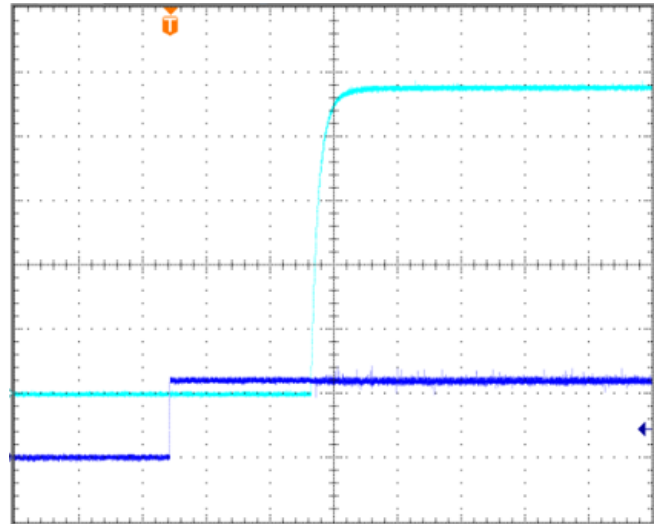

Turn-on transient at full load current (100ms/div).
Top Trace: Vout, 10V/div; Bottom Trace: input voltage, 20V/div.

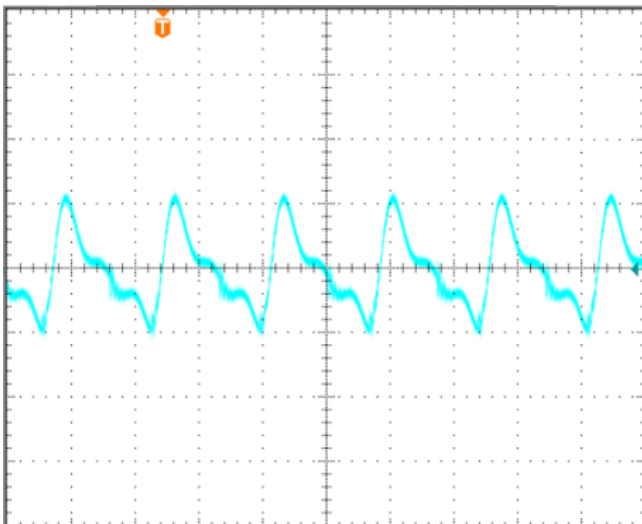

Output voltage ripple at nominal input voltage and max load current (100mV/div, 2us/div)
Load cap: 33uF Low ESR Polymer; 10uF Low ESR Polymer; 1uF ceramic capacitor
Bandwidth: 20MHz

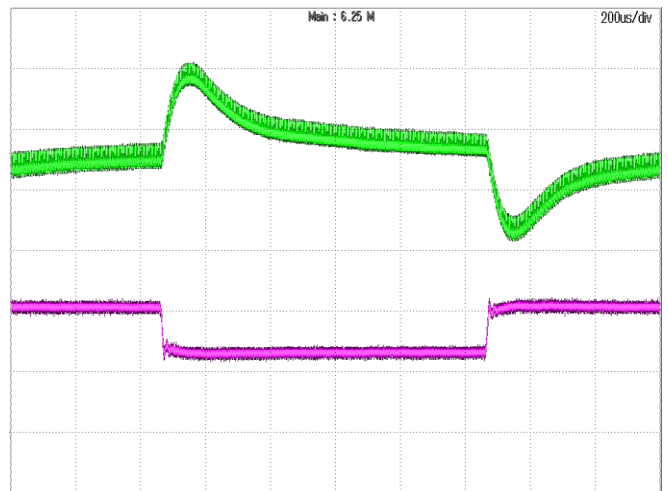

Top trace Vout dynamic AC value, 500mV/div, 200us/div,
Load Cap: 33uF Low ESR Polymer; 10uF Low ESR Polymer; 1uF ceramic capacitor
Bottom Trace, load 50% to 70% of rated Io, 1A/div,
Bandwidth: 20MHz

Input Source Impedance

The impedance of the input source connecting to the DC/DC power modules will interact with the modules and affect the stability. A low ac-impedance input source is recommended. If the source inductance is more than a few μH , we advise a $100\mu\text{F}$ electrolytic capacitor mounted close to the input of the module to improve the stability.

Input Reflected Ripple Current

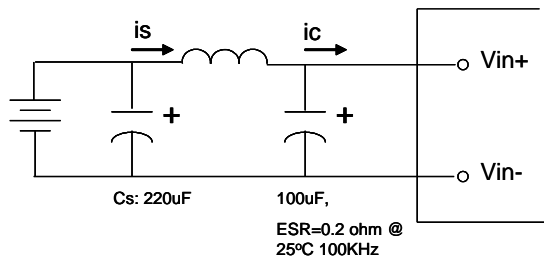

Test set-up diagram showing measurement points for Input Terminal Ripple Current and Input Reflected Ripple Current. Measured input reflected-ripple current with a simulated source Inductance (LTEST) of $12\mu\text{H}$. Capacitor Cs offset possible battery impedance.

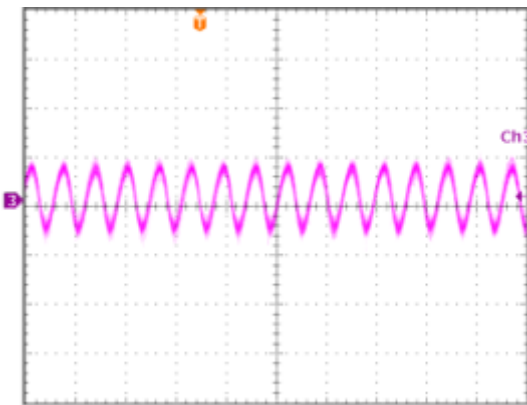

Input Terminal Ripple Current, i_c , at full rated output current and nominal input voltage with $12\mu\text{H}$ source impedance and $100\mu\text{F}$ electrolytic capacitor (500 mA/div, 5us/div).

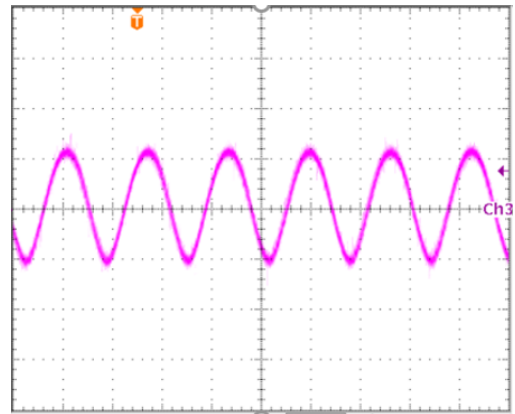

Input reflected ripple current, i_s , through a $12\mu\text{H}$ source inductor at nominal input voltage and rated load current (50 mA/div, 5us/div)

Output Ripple Noise

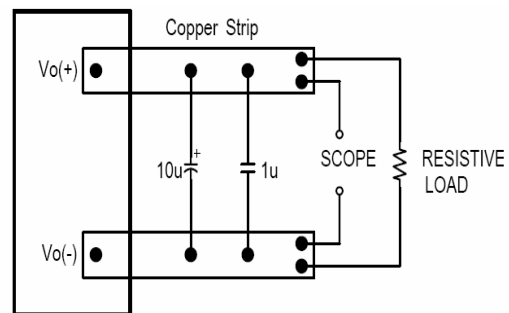

Output voltage ripple test setup. Load capacitance: $1\mu\text{F}$ ceramic capacitor and some extra Polymer capacitor may be needed. Bandwidth: 20 MHz. Scope measurements should be made using a BNC cable (length shorter than 20 inches). Position the load between 51 mm to 76 mm (2 inches to 3 inches) from the module.

Layout and EMI Considerations

Delta's DC/DC power modules are designed to operate in a wide variety of systems and applications. For design assistance with EMC compliance and related PWB layout issues, please contact Delta's technical support team.

Below is the EN55032 Class A Conducted Emission test result using typical EMI filter circuit.
At T = +25°C, Typical input voltage and full load.

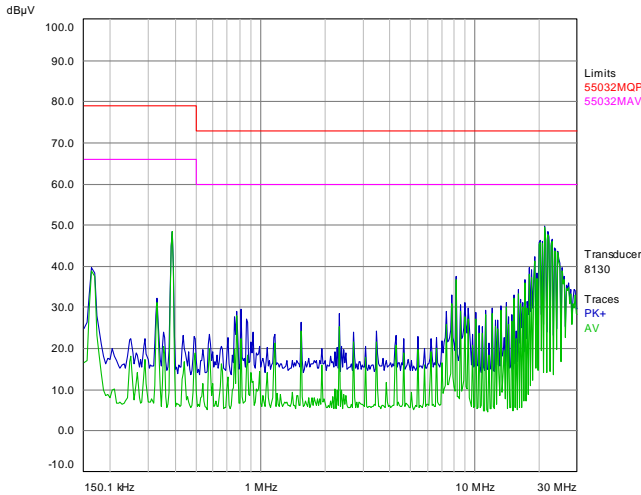

E35SE05030
EN55032 Class A Conducted Emission Test Result

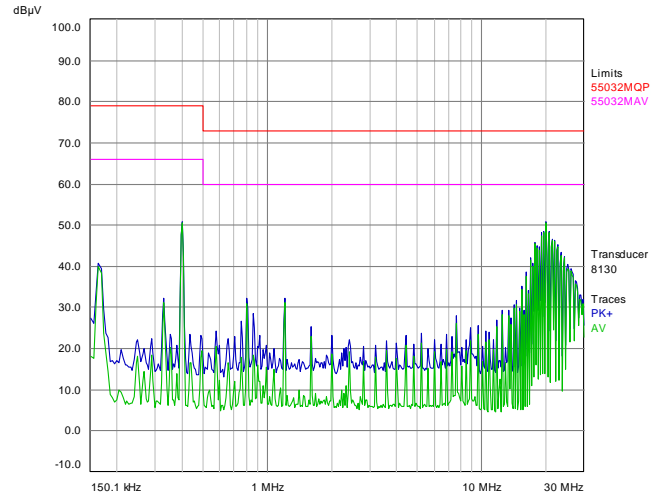

E35SE12013
EN55032 Class A Conducted Emission Test Result

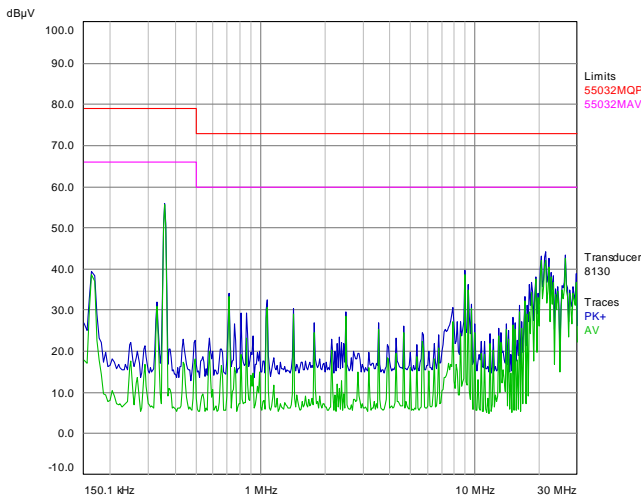

E35SE24006
EN55032 Class A Conducted Emission Test Result

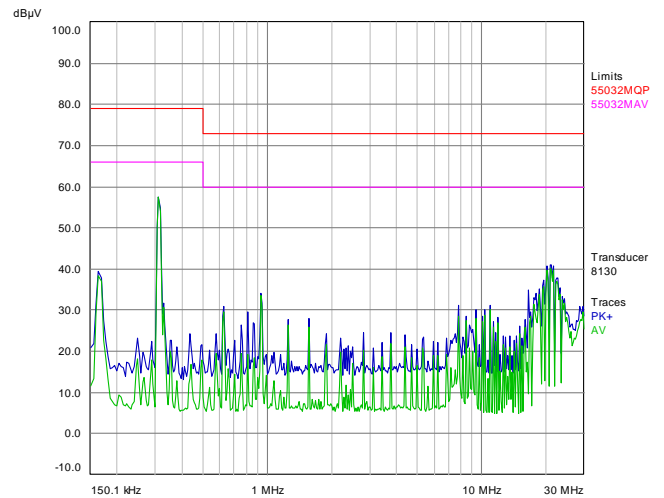

E35SE48003
EN55032 Class A Conducted Emission Test Result

Recommended PCB Layout

It is suggested to use multiple layers PCB and large size copper on system board which connects to pins of module, that can achieve better thermal performance.

Features Descriptions

Over-Current Protection

The modules include an internal output over-current protection circuit, which will endure current limiting for an unlimited duration during output overload. If the output current exceeds the OCP set point, the modules will shut down (hiccup mode).

The modules will try to restart after shutdown. If the overload condition still exists, the module will shut down again. This restart trial will continue until the overload condition is corrected.

Over-Voltage Protection

The modules include an internal output over-voltage protection circuit, which monitors the voltage on the output terminals. If this voltage exceeds the over-voltage set point, the modules will shut down, and then restart after a hiccup-time (hiccup mode).

Over-Temperature Protection

The over-temperature protection consists of circuitry that provides protection from thermal damage. If the over-temperature is detected the module will shut down, and restart after the temperature is within specification.

Remote On/Off

The remote on/off feature on the module can be either negative or positive logic depend on the part number options on the last page.

- ❖ For Negative logic version, turns the module on during an external logic low and off during a logic high. If the remote on/off feature is not used, please short the on/off pin to Vi (-).
- ❖ For Positive logic version, turns the modules on during an external logic high and off during a logic low. If the remote on/off feature is not used, please leave the on/off pin to floating.

Remote on/off can be controlled by an external switch between the on/off terminal and the Vi (-) terminal. The switch can be an open collector or open drain.

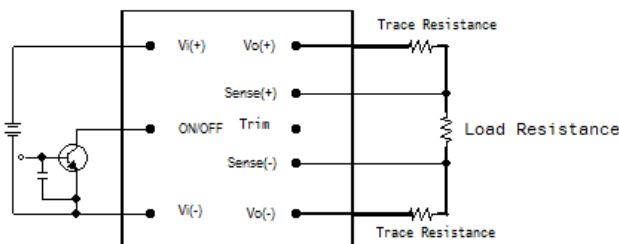

Remote on/off implementation

Output Voltage Adjustment (TRIM)

To increase the output voltage set point, connect an external resistor between the TRIM pin and the Sense(+).

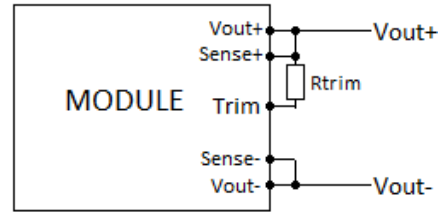

Circuit for trim-up (increase output voltage)

To decrease the output voltage set point, connect an external resistor between the TRIM pin and the Sense(-).

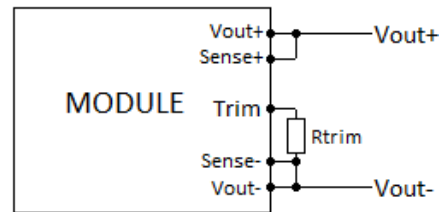

Circuit for trim-down (decrease output voltage)

The maximum adjust range is $\pm 20\%$, the TRIM pin should be left open if this feature is not used.

Take E35SE12013 as example, for trim down, the external resistor value required to obtain a percentage of output voltage change Δ is defined as:

$$R_{trim-down} = \left[\frac{5.11}{\Delta} - 10.22 \right] (K\Omega)$$

Ex. When Trim-down -10% ($12V \times 0.9 = 10.8V$)

$$R_{trim-down} = \left[\frac{5.11}{10\%} - 10.22 \right] (K\Omega) = 40.88 (K\Omega)$$

For trim up, the external resistor value required to obtain a percentage output voltage change Δ is defined as:

$$R_{trim-up} = \left[\frac{45}{\Delta} + 40 \right] K\Omega$$

Ex. When Trim-up +10% ($12V \times 110\% = 13.2V$)

$$R_{trim-up} = \left[\frac{45}{10\%} + 40 \right] = 490 (K\Omega)$$

Models	Rtrim-up /kohm	Rtrim-down/kohm
E35SE05030	$15.8/\Delta + 10.6$	$5.11/\Delta - 10.22$
E35SE12013	$45/\Delta + 40$	$5.11/\Delta - 10.22$
E35SE24006	$95/\Delta + 90$	$5.11/\Delta - 10.22$
E35SE48003	$195/\Delta + 190$	$5.11/\Delta - 10.22$

Where

$\Delta = |V_{nom} - V_{adj}| / V_{nom}$

V_{nom} = Typical Output Voltage

V_{adj} = Disired Output Voltage

Safety Considerations

The power module must be installed in compliance with the spacing and separation requirements of the end-user's safety agency standard, i.e., EN 60950-1: 2006 + A11: 2009 + A1: 2010 + A12: 2011 + A2: 2013, IEC 60950-1: 2005, 2nd Edition + A1: 2009 + A2: 2013, CSA C22.2 No. 60950-1-07, 2nd Edition, 2014-10 and UL 60950-1, 2nd Edition, 2014-10-14, EN 62368-1: 2014, IEC 62368-1: 2014, CSA C22.2 No. 62368-1-14, 2nd Edition and UL 62368-1, 2nd Edition, if the system in which the power module is to be used must meet safety agency requirements.

This power module is not internally fused. To achieve optimum safety and system protection, an input line fuse is highly recommended. The safety agencies require a fast-blow fuse with 30A maximum rating to be installed in the ungrounded lead. A lower rated fuse can be used based on the maximum inrush transient energy and maximum input current.

Soldering and Cleaning Considerations

Post solder cleaning is usually the final board assembly process before the board or system undergoes electrical testing. Inadequate cleaning and/or drying may lower the reliability of a power module and severely affect the finished circuit board assembly test. Adequate cleaning and/or drying is especially important for un-encapsulated and/or open frame type power modules. For assistance on appropriate soldering and cleaning procedures, please contact Delta's technical support team

Thermal Testing Setup (Airflow Cooling)

Thermal management is an important part of the system design. To ensure proper, reliable operation, sufficient cooling of the power module is needed over the entire temperature range of the module. Convection cooling is usually the dominant mode of heat transfer.

Hence, the choice of equipment to characterize the thermal performance of the power module is a wind tunnel.

Delta's DC/DC power modules are characterized in heated vertical wind tunnels that simulate the thermal environments encountered in most electronics equipment. This type of equipment commonly uses vertically mounted circuit cards in cabinet racks in which the power modules are mounted.

The following figure shows the wind tunnel characterization setup. The power module is mounted on a 185mmX185mm, 105µm (3Oz), 6 layers' thermal test PWB and is vertically positioned within the wind tunnel. The space between the neighboring PWB and the top of the power module is constantly kept at 6.35mm (0.25").

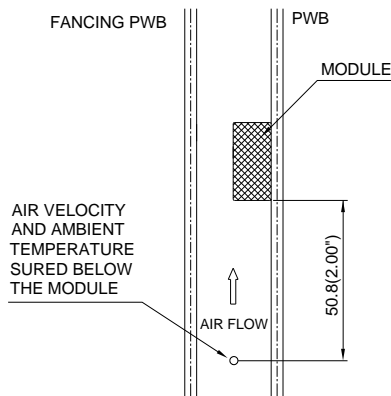

Note: Wind Tunnel Test Setup Figure Dimensions are in millimeters and (Inches)

Figure 1: Wind Tunnel Test Setup

Thermal Derating

Heat can be removed by increasing airflow over the module. To enhance system reliability, the power module should always be operated below the maximum operating temperature. If the temperature exceeds the maximum module temperature, reliability of the unit may be affected.

Thermal Curves (Open Frame)

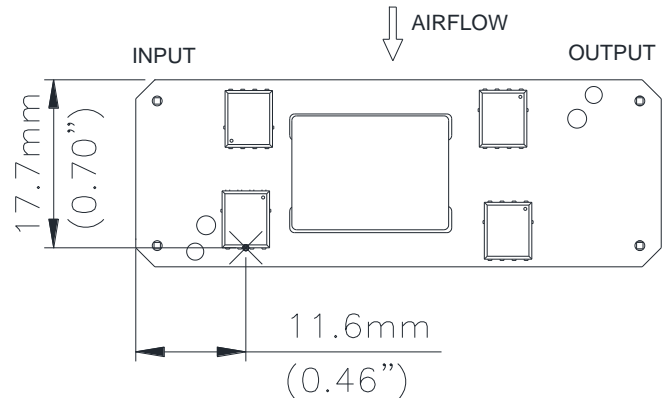

Figure 2: * Hot spot1 temperature measured point. The allowed maximum hotspot1 temperature is defined at 120°C.

Thermal Curves (E35SE05030, Open Frame)

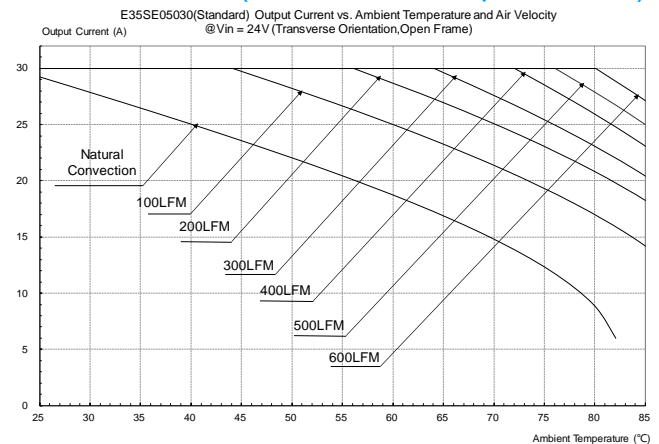

Figure 3: E35SE05030 Output current vs. ambient temperature and air velocity @ $V_{in}=24V$ (Transverse Orientation, Airflow from Vin+ to Vin-, Open Frame)

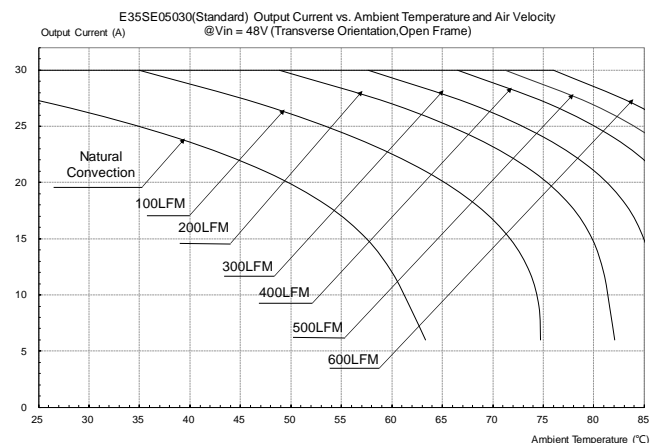

Figure 4: E35SE05030 Output current vs. ambient temperature and air velocity @ $V_{in}=48V$ (Transverse Orientation, Airflow from Vin+ to Vin-, Open Frame)

Thermal Curves (E35SE12013, Open Frame)

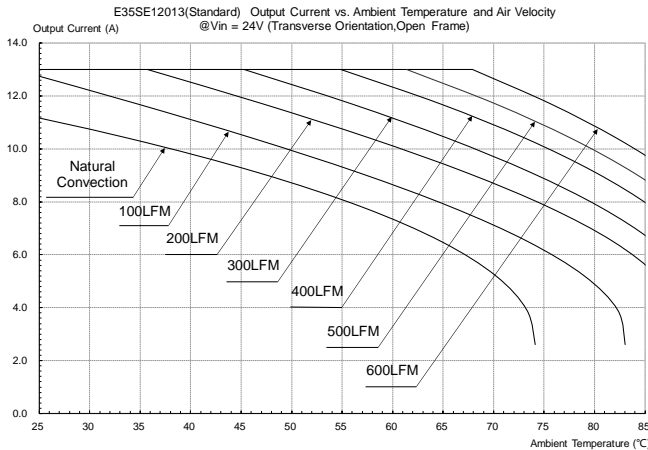

Figure 5: E35SE12013 Output current vs. ambient temperature and air velocity @ $V_{in}=24V$ (Transverse Orientation, Airflow from V_{in+} to V_{in-} , Open Frame)

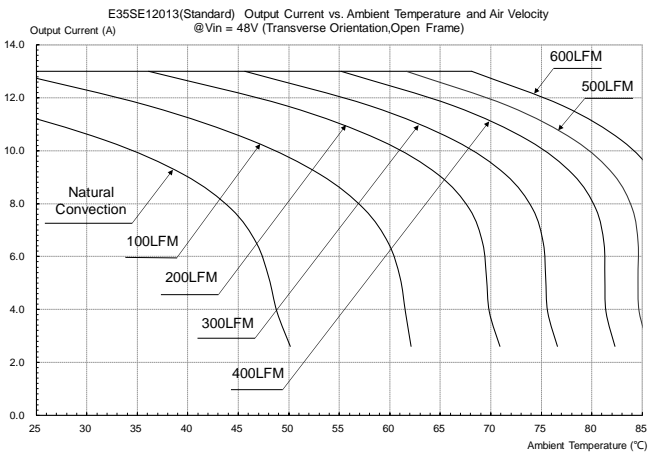

Figure 6: E35SE12013 Output current vs. ambient temperature and air velocity @ $V_{in}=48V$ (Transverse Orientation, Airflow from V_{in+} to V_{in-} , Open Frame)

Thermal Curves (E35SE24006, Open Frame)

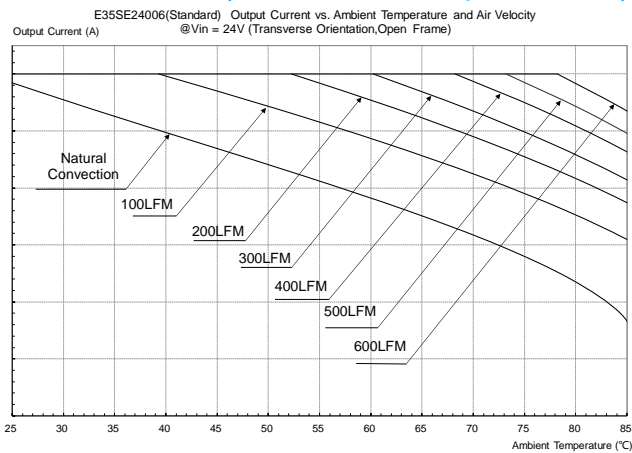

Figure 7: E35SE24006 Output current vs. ambient temperature and air velocity @ $V_{in}=24V$ (Transverse Orientation, Airflow from V_{in+} to V_{in-} , Open Frame)

Thermal Curves (E35SE24006, Open Frame)

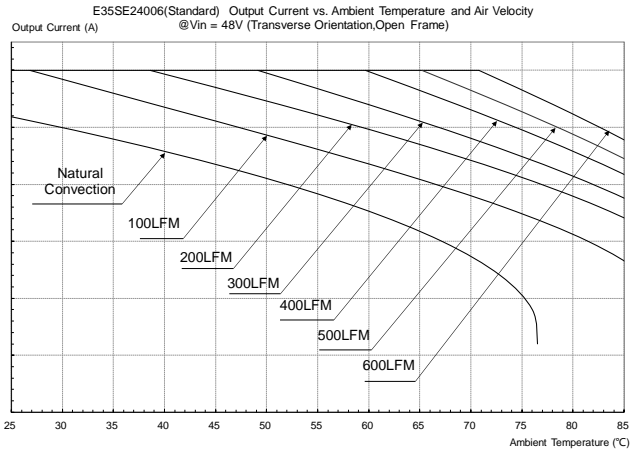

Figure 8: E35SE24006 Output current vs. ambient temperature and air velocity @ $V_{in}=48V$ (Transverse Orientation, Airflow from V_{in+} to V_{in-} , Open Frame)

Thermal Curves (E35SE48003, Open Frame)

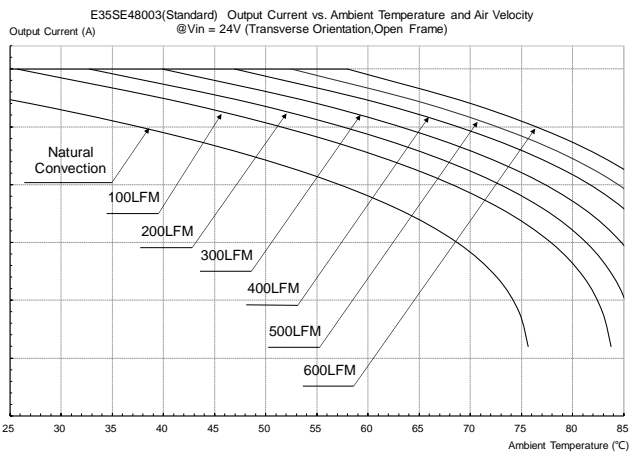

Figure 9: E35SE48003 Output current vs. ambient temperature and air velocity @ $V_{in}=24V$ (Transverse Orientation, Airflow from V_{in+} to V_{in-} , Open Frame)

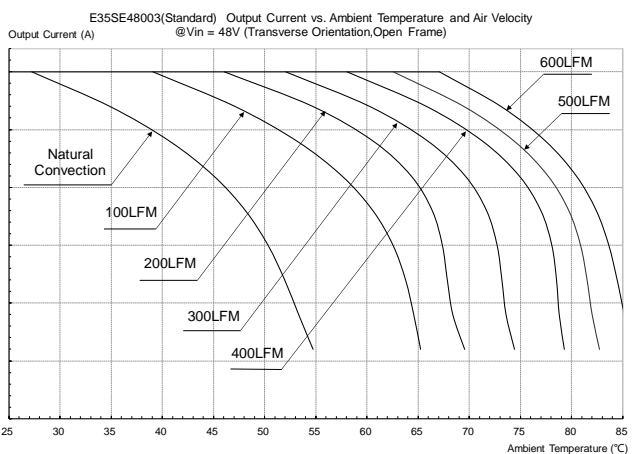

Figure 10: E35SE48003 Output current vs. ambient temperature and air velocity @ $V_{in}=48V$ (Transverse Orientation, Airflow from V_{in+} to V_{in-} , Open Frame)

Thermal Curves (With Baseplate)

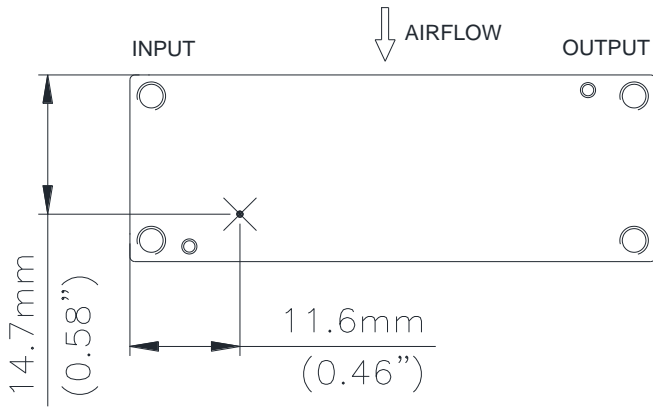

Figure 11: * Hot spot2 temperature measured point. The allowed maximum hotspot2 temperature is defined at 110°C.

Thermal Curves(E35SE12013,With Baseplate)

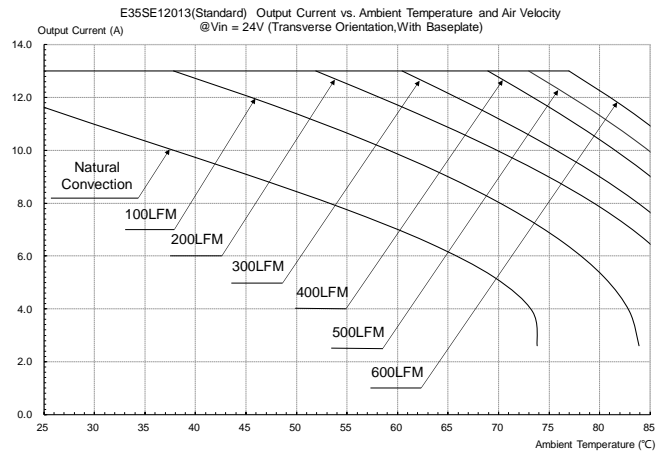

Figure 14:E35SE12013 Output current vs. ambient temperature and air velocity @ $V_{in}=24V$ (Transverse Orientation, Airflow from V_{in+} to V_{in-} , With Baseplate)

Thermal Curves (E35SE05030, With Baseplate)

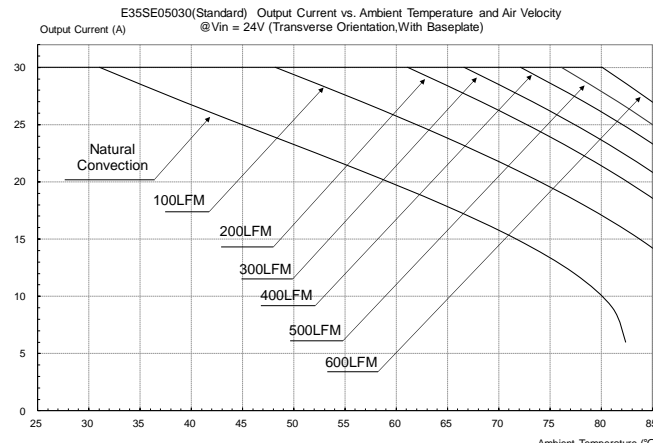

Figure 12:E35SE05030 Output current vs. ambient temperature and air velocity @ $V_{in}=24V$ (Transverse Orientation, Airflow from V_{in+} to V_{in-} , With Baseplate)

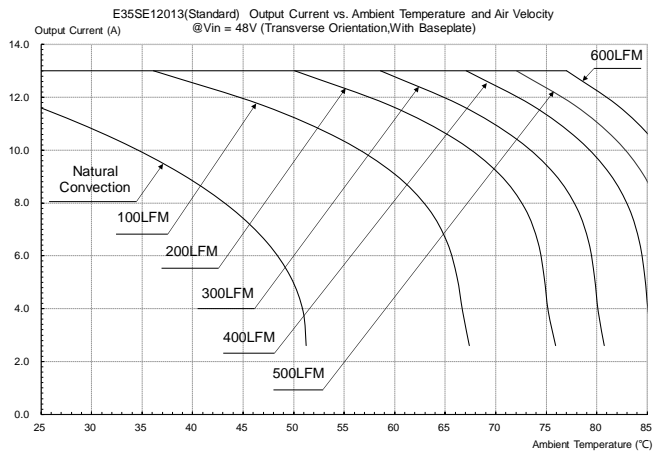

Figure 15:E35SE12013 Output current vs. ambient temperature and air velocity @ $V_{in}=48V$ (Transverse Orientation, Airflow from V_{in+} to V_{in-} , With Baseplate)

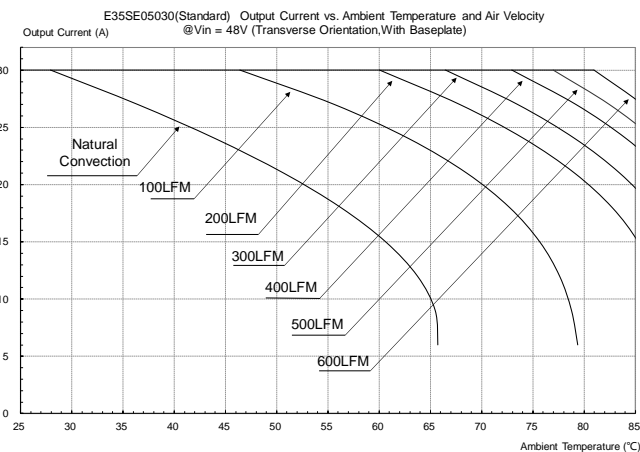

Figure 13: E35SE05030 Output current vs. ambient temperature and air velocity @ $V_{in}=48V$ (Transverse Orientation, Airflow from V_{in+} to V_{in-} , With Baseplate)

Thermal Curves(E35SE24006,With Baseplate)

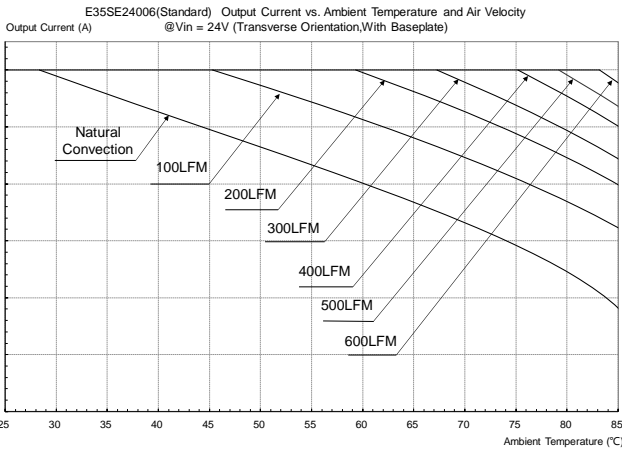

Figure 16: E35SE24006 Output current vs. ambient temperature and air velocity @ $V_{in}=24V$ (Transverse Orientation, Airflow from V_{in+} to V_{in-} , With Baseplate)

Thermal Curves(E35SE48003,With Baseplate)

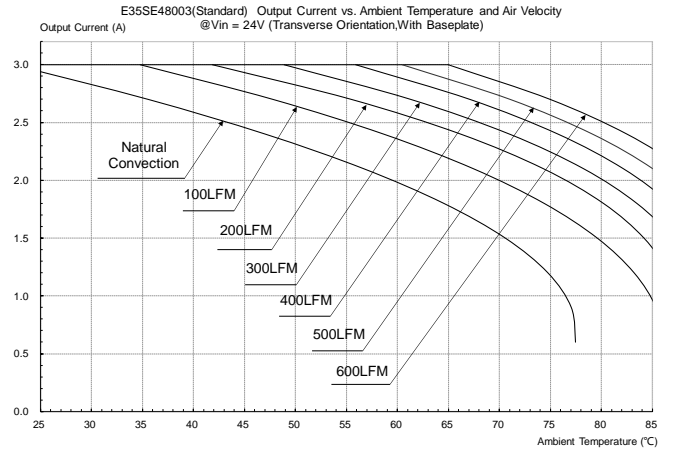

Figure 18: E35SE48003 Output current vs. ambient temperature and air velocity @ $V_{in}=24V$ (Transverse Orientation, Airflow from V_{in+} to V_{in-} , With Baseplate)

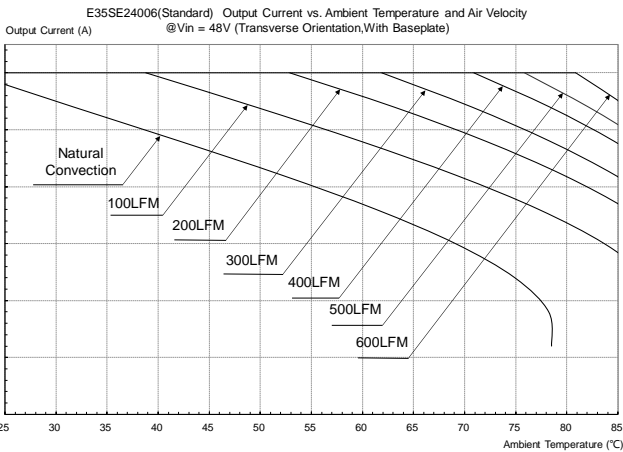

Figure 17: E35SE24006 Output current vs. ambient temperature and air velocity @ $V_{in}=48V$ (Transverse Orientation, Airflow from V_{in+} to V_{in-} , With Baseplate)

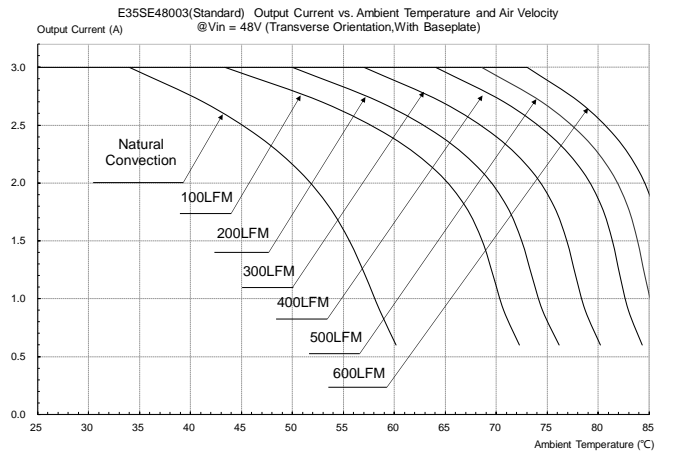

Figure 19: E35SE48003 Output current vs. ambient temperature and air velocity @ $V_{in}=48V$ (Transverse Orientation, Airflow from V_{in+} to V_{in-} , With Baseplate)

Thermal Curves (With Baseplate and Potting)

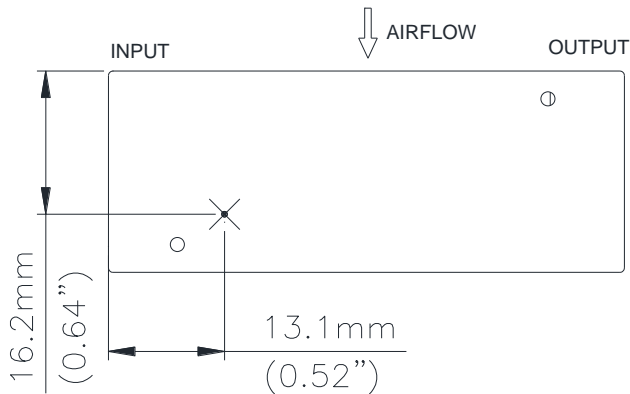

Figure 20: * Hot spot3 temperature measured point.
The allowed maximum hotspot3 temperature is defined at 106°C.

Thermal Curves (E35SE05030,With Baseplate and Potting)

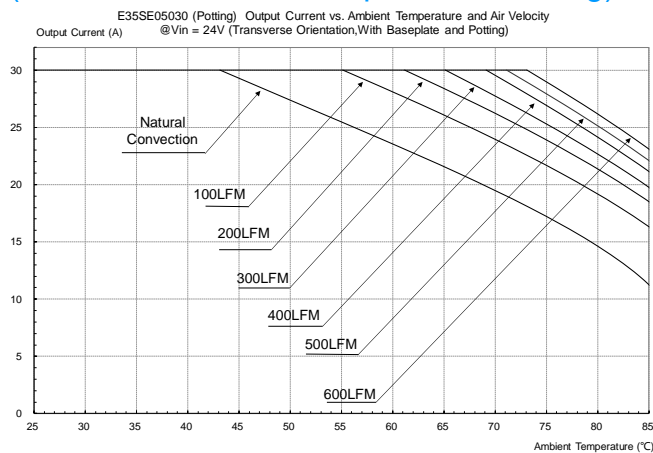

Figure 21: E35SE05030 Output current vs. ambient temperature and air velocity @ $V_{in}=24V$ (Transverse Orientation, Airflow from V_{in+} to V_{in-} , With Baseplate and Potting)

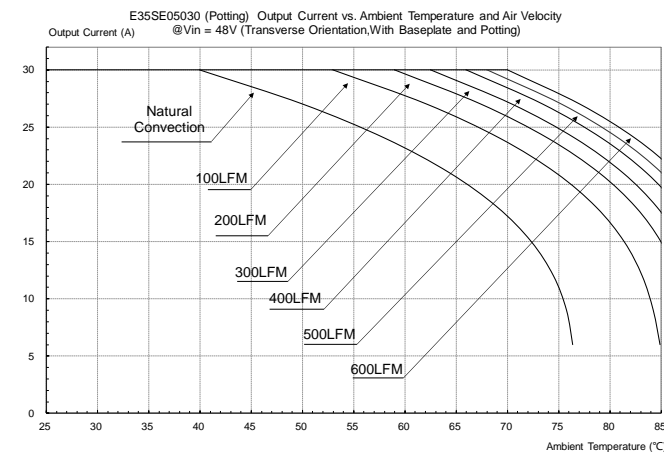

Figure 22: E35SE05030 Output current vs. ambient temperature and air velocity @ $V_{in}=48V$ (Transverse Orientation, Airflow from V_{in+} to V_{in-} , With Baseplate and Potting)

Thermal Curves (E35SE12013,With Baseplate and Potting)

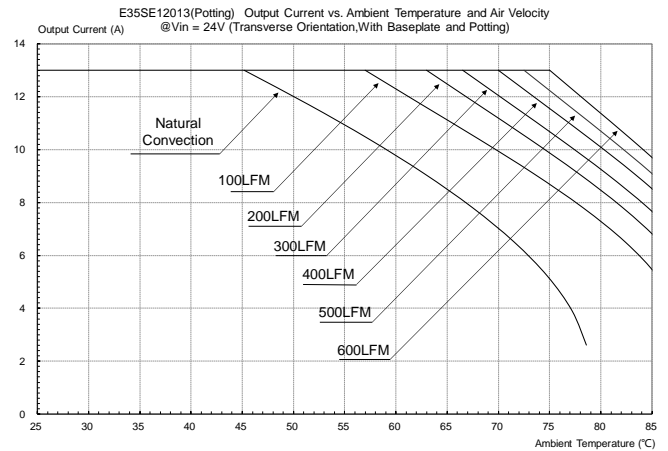

Figure 23: E35SE12013 Output current vs. ambient temperature and air velocity @ $V_{in}=24V$ (Transverse Orientation, Airflow from V_{in+} to V_{in-} , With Baseplate and Potting)

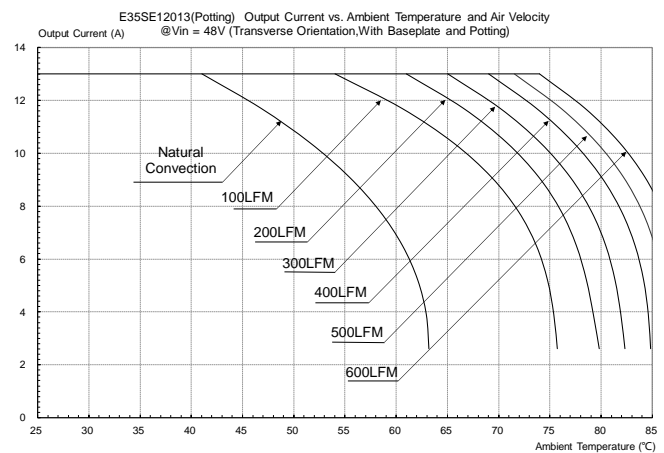

Figure 24: E35SE12013 Output current vs. ambient temperature and air velocity @ $V_{in}=48V$ (Transverse Orientation, Airflow from V_{in+} to V_{in-} , With Baseplate and Potting)

Thermal Curves (E35SE24006,With Baseplate and Potting)

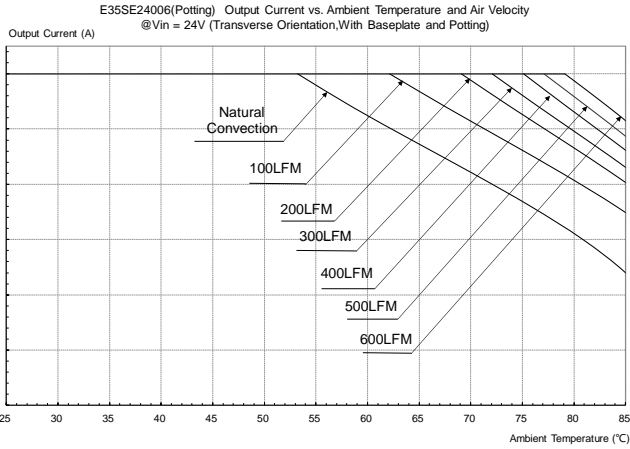

Figure 25:E35SE24006 Output current vs. ambient temperature and air velocity @ $V_{in}=24V$ (Transverse Orientation, Airflow from V_{in+} to V_{in-} , With Baseplate and Potting)

Thermal Curves (E35SE48003,With Baseplate and Potting)

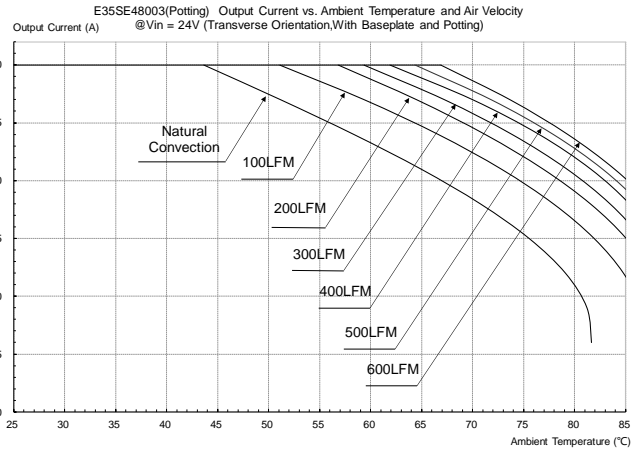

Figure 27:E35SE48003 Output current vs. ambient temperature and air velocity @ $V_{in}=24V$ (Transverse Orientation, Airflow from V_{in+} to V_{in-} , With Baseplate and Potting)

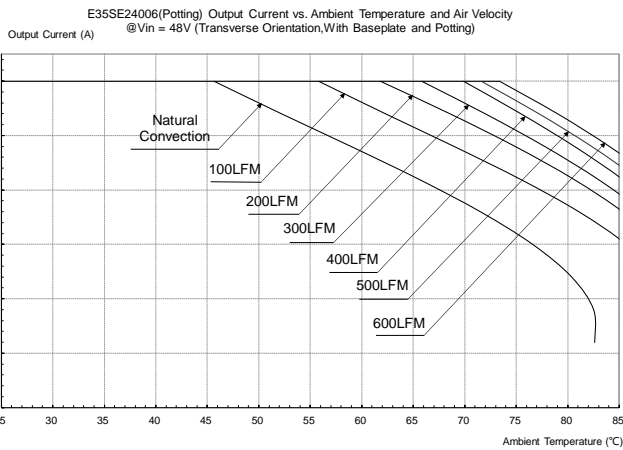

Figure 26:E35SE24006 Output current vs. ambient temperature and air velocity @ $V_{in}=48V$ (Transverse Orientation, Airflow from V_{in+} to V_{in-} , With Baseplate and Potting)

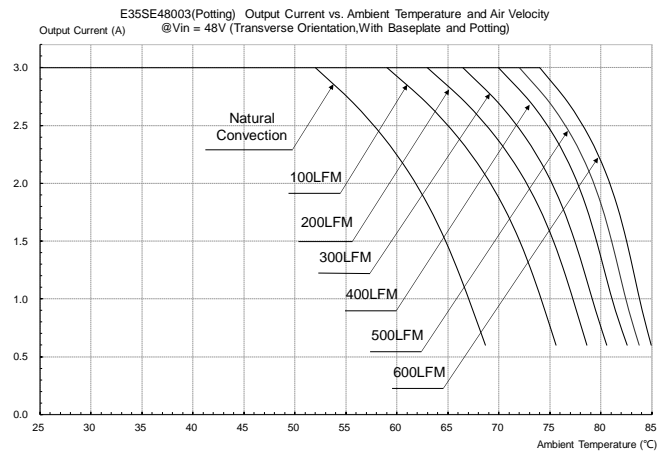

Figure 28:E35SE48003 Output current vs. ambient temperature and air velocity @ $V_{in}=48V$ (Transverse Orientation, Airflow from V_{in+} to V_{in-} , With Baseplate and Potting)

Thermal Testing Setup (Cold Plate Cooling)

The following figure shows cold plate cooling test setup. The power module is mounted on a 185mmX185mm,105µm (3Oz),6 layers' test PWB and attach to a cold plate with thermal interface material (TIM).

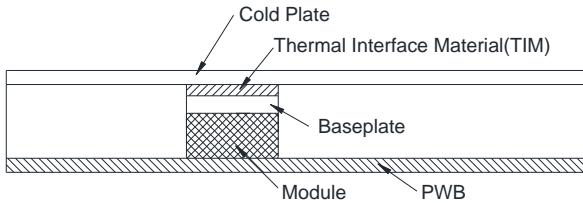

Figure 29: Cold Plate Cooling Test Setup

Thermal Curves (With Baseplate and Potting, Attach to Cold Plate)

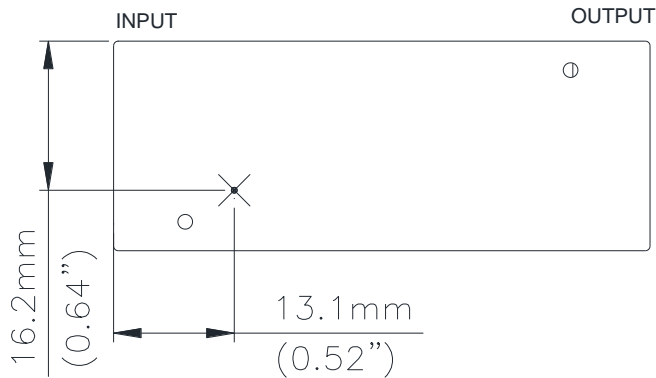

Figure 30: * Hot spot4 temperature measured point. The allowed maximum hotspot4 temperature is defined at 103°C .

Thermal Curves (E35SE05030, With Baseplate and Potting, Attach to Cold Plate)

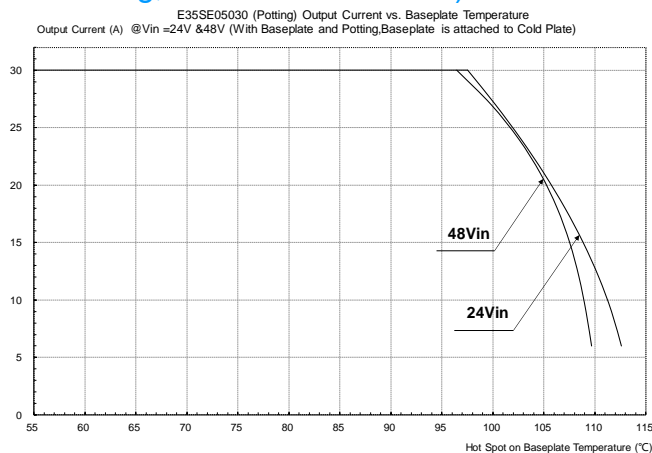

Figure 31:E35SE05030 Output Current vs. Hot Spot on Baseplate Temperature @ $V_{in}=24V\&48V$ (With Baseplate and Potting, Attach to Cold Plate)

Thermal Curves (E35SE12013, With Baseplate and Potting, Attach to Cold Plate)

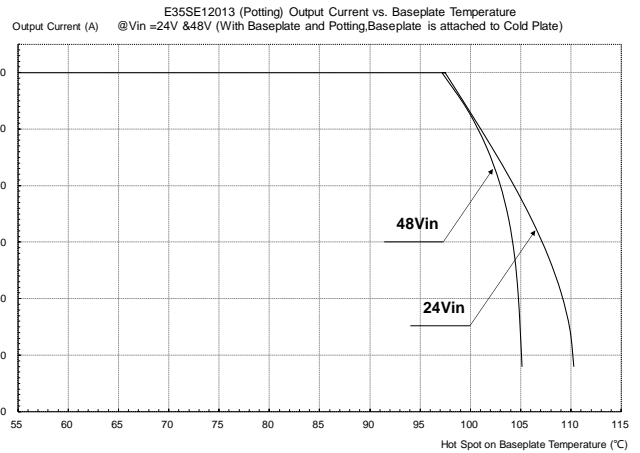

Figure 32:E35SE12013 Output Current vs. Hot Spot on Baseplate Temperature @ $V_{in}=24V\&48V$ (With Baseplate and Potting, Attach to Cold Plate)

Thermal Curves (E35SE24006, With Baseplate and Potting, Attach to Cold Plate)

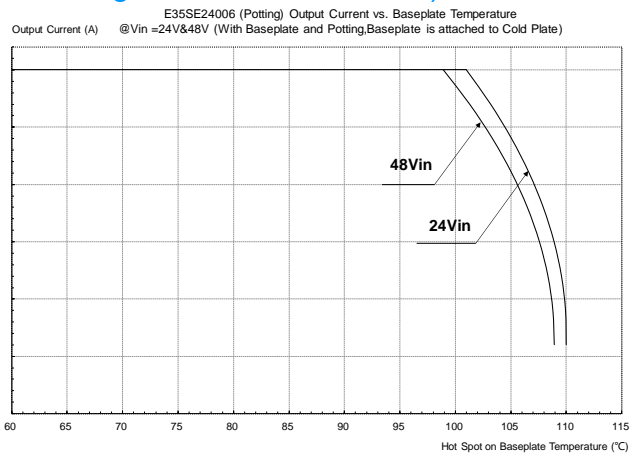

Figure 33:E35SE24006 Output Current vs. Hot Spot on Baseplate Temperature @ $V_{in}=24V\&48V$ (With Baseplate and Potting, Attach to Cold Plate)

Thermal Curves (E35SE48003, With Baseplate and Potting, Attach to Cold Plate)

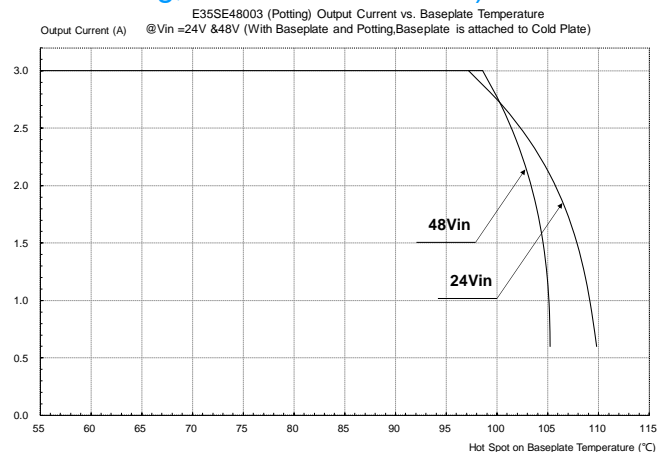

Figure 34:E35SE48003 Output Current vs. Hot Spot on Baseplate Temperature @ $V_{in}=24V\&48V$ (With Baseplate and Potting, Attach to Cold Plate)

Generally, as the most common mass soldering method for the solder attachment, wave soldering is used for through-hole power modules and reflow soldering is used for surface-mount ones. Delta recommended soldering methods and process parameters are provided in this document for solder attachment of power modules onto system board. SAC305 is the suggested lead-free solder alloy for all soldering methods.

Reflow soldering is not a suggested method for through-hole power modules due to many process and reliability concerns. If you have this kind of application requirement, please contact Delta sales or FAE for further confirmation.

Wave Soldering (Lead-free)

Delta's power modules are designed to be compatible with single-wave or dual wave soldering. The suggested soldering process must keep the power module's internal temperature below the critical temperature of 217°C continuously. The recommended wave-soldering profile is shown in following figure.

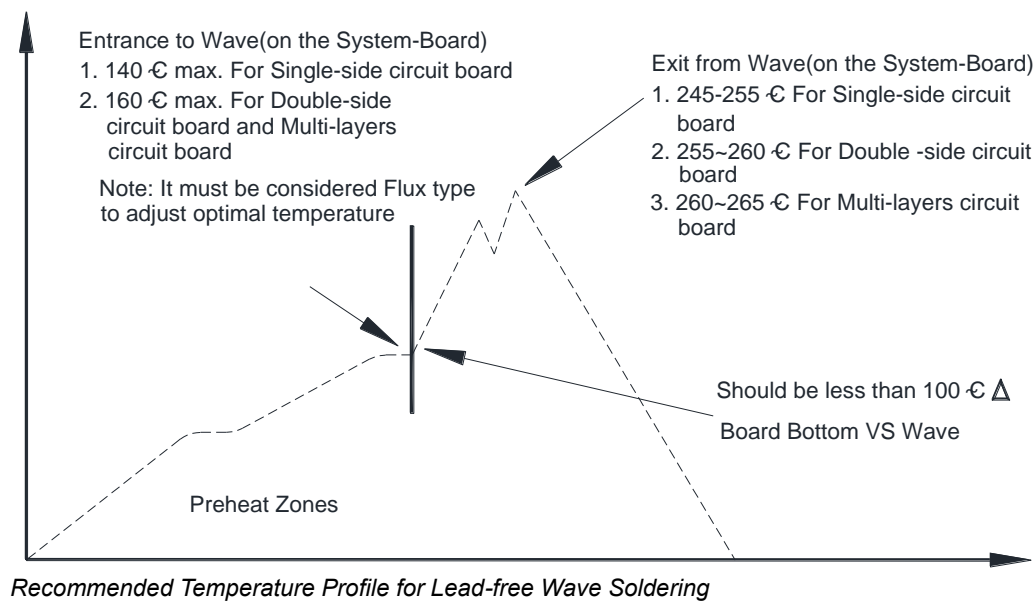

The typical recommended (for double-side circuit board) preheat temperature is 115+/-10°C on the top side (component side) of the circuit board. The circuit-board bottom-side preheat temperature is typically recommended to be greater than 135°C and preferably within 100 °C of the solder-wave temperature. A maximum recommended preheat up rate is 3°C /s. A maximum recommended solder pot temperature is 255+/-5°C with solder-wave dwell time of 3~6 seconds. The cooling down rate is typically recommended to be 6°C/s maximum.

Hand Soldering (Lead Free)

Hand soldering is the least preferred method because the amount of solder applied, the time the soldering iron is held on the joint, the temperature of the iron, and the temperature of the solder joint are variable. The recommended hand soldering guideline is listed in Table below. The suggested soldering process must keep the power module's internal temperature below the critical temperature of 217°C continuously.

Table Hand-Soldering Guideline

Parameter	Single-side Circuit Board	Double-side Circuit Board	Multi-layers Circuit Board
Soldering Iron Wattage	90	90	90
Tip Temperature	385+/-10°C	420+/-10°C	420+/-10°C
Soldering Time	2 ~ 6 seconds	4 ~ 10 seconds	4 ~ 10 seconds

CONTACT US:

Website: www.deltaww.com/dcdc

Email: dcdc@deltaww.com

USA:

Telephone:
East Coast: 978-656-3993
West Coast: 510-668-5100
Fax: 510-668-0680

Europe:

Telephone: +31-20-800-3900
Fax: +31-20-800-3999

Asia & the rest of world:

Telephone: +886-3-452-6107
Ext. 6221~6226
Fax: +886-3-433-1810



WARRANTY

Delta offers a two (2) years limited warranty. Complete warranty information is listed on our web site or is available upon request from Delta.





Information furnished by Delta is believed to be accurate and reliable. However, no responsibility is assumed by Delta for its use, nor for any infringements of patents or other rights of third parties, which may result from its use. No license is granted by implication or otherwise under any patent or patent rights of Delta. Delta reserves the right to revise these specifications at any time, without notice.

Looking for pricing, stock, or lifecycle information?

Click below to explore more details on WIN SOURCE:

-  [View E35SE24006PDPG on WIN SOURCE](#)
-  [Delta Electronics Information](#)

Optimize Your Supply Chain with WIN SOURCE Solutions

-  Global Sourcing Solution
-  Obsolete Management
-  Cost Control Management
-  Shortage Management
-  Alternative Solution
-  Excess Inventory Management