



**THE DATASHEET OF
IAUA250N04S6N007EAUMA1**



Automotive MOSFET

OptiMOS™ 6 Power-Transistor



Features

- OptiMOS™ power MOSFET for automotive applications
- N-channel – Enhancement mode – Normal Level
- Extended qualification beyond AEC-Q101
- Enhanced electrical testing
- Robust design
- MSL3 up to 260°C peak reflow
- 175°C operating temperature
- Green product (RoHS compliant)
- 100% Avalanche tested

Potential applications

General automotive applications.

Product validation

Qualified for automotive applications. Product validation according to AEC-Q101.

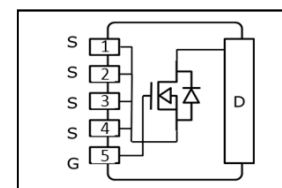

Product Summary

V_{DS}	40	V
$R_{DS(on),max}$	0.7	mΩ
I_D (chip limited)	380	A

Type	Package	Marking
IAUA250N04S6N007E	PG-HSOF-5-1	6N04R7E



Table of Contents

Description	1
Maximum ratings	3
Thermal characteristics	4
Electrical characteristics	4
Electrical characteristics diagrams	6
Package outline & footprint	10
Disclaimer	11
Revision history	12

Maximum ratings

at $T_j=25\text{ °C}$, unless otherwise specified

Parameter	Symbol	Conditions	Value	Unit
Continuous drain current	I_D	$V_{GS} = 10\text{ V}$, Chip limitation ^{1,2)}	380	A
		$V_{GS} = 10\text{ V}$, DC current ³⁾	250	
		$T_a = 85\text{ °C}$, $V_{GS} = 10\text{ V}$, R_{thJA} on 2s2p ^{2,4)}	55	
Pulsed drain current ²⁾	$I_{D,pulse}$	$T_C = 25\text{ °C}$, $t_p = 100\text{ }\mu\text{s}$	1300	
Avalanche energy, single pulse ²⁾	E_{AS}	$I_D = 55\text{ A}$, $R_{G,min} = 25\text{ }\Omega$	560	mJ
Avalanche current, single pulse	I_{AS}	$R_{G,min} = 25\text{ }\Omega$	110	A
Gate source voltage	V_{GS}	–	± 20	V
Power dissipation	P_{tot}	$T_C = 25\text{ °C}$	192	W
Operating and storage temperature	T_j, T_{stg}	–	-55 ... +175	°C

Thermal characteristics²⁾

Parameter	Symbol	Conditions	Values			Unit
			min.	typ.	max.	
Thermal resistance, junction - case	R_{thJC}	–	–	–	0.78	K/W
Thermal resistance, junction - ambient ⁴⁾	R_{thJA}	–	–	22.9	–	

Electrical characteristics

 at $T_j=25\text{ °C}$, unless otherwise specified

Parameter	Symbol	Conditions	Values			Unit
			min.	typ.	max.	

Static characteristics

Drain-source breakdown voltage	$V_{(BR)DSS}$	$V_{GS} = 0\text{ V}$, $I_D = 1\text{ mA}$	40	–	–	V
Gate threshold voltage	$V_{GS(th)}$	$V_{DS} = V_{GS}$, $I_D = 110\text{ }\mu\text{A}$	2.2	2.6	3.0	
Zero gate voltage drain current	I_{DSS}	$V_{DS} = 40\text{ V}$, $V_{GS} = 0\text{ V}$, $T_j = 25\text{ °C}$	–	–	1	μA
		$V_{DS} = 40\text{ V}$, $V_{GS} = 0\text{ V}$, $T_j = 125\text{ °C}^{2)}$	–	–	31	
Gate-source leakage current	I_{GSS}	$V_{GS} = 20\text{ V}$, $V_{DS} = 0\text{ V}$	–	–	100	nA
Drain-source on-state resistance	$R_{DS(on)}$	$V_{GS} = 7\text{ V}$, $I_D = 100\text{ A}$	–	0.65	0.83	m Ω
		$V_{GS} = 10\text{ V}$, $I_D = 100\text{ A}$	–	0.55	0.70	
Gate resistance ²⁾	R_G	–	–	1	–	Ω

Parameter	Symbol	Conditions	Values			Unit
			min.	typ.	max.	

Dynamic characteristics²⁾

Input capacitance	C_{iss}	$V_{GS} = 0\text{ V}, V_{DS} = 25\text{ V},$ $f = 1\text{ MHz}$	-	6444	8377	pF
Output capacitance	C_{oss}		-	1944	2528	
Reverse transfer capacitance	C_{rss}		-	94	124	
Turn-on delay time	$t_{d(on)}$	$V_{DD} = 32\text{ V}, V_{GS} = 10\text{ V},$ $I_D = 250\text{ A}, R_G = 3.5\ \Omega$	-	13	-	ns
Rise time	t_r		-	14	-	
Turn-off delay time	$t_{d(off)}$		-	27	-	
Fall time	t_f		-	19	-	

Gate Charge Characteristics²⁾

Gate to source charge	Q_{gs}	$V_{DD} = 32\text{ V}, I_D = 250\text{ A},$ $V_{GS} = 0\text{ to }10\text{ V}$	-	28	36	nC
Gate to drain charge	Q_{gd}		-	19	29	
Gate charge total	Q_g		-	94	128	
Gate plateau voltage	$V_{plateau}$		-	4.2	-	V

Reverse Diode

Diode continuous forward current ²⁾	I_S	$T_C = 25\text{ °C}$	-	-	250	A
Diode pulse current ²⁾	$I_{S,pulse}$	$T_C = 25\text{ °C}, t_p = 100\ \mu\text{s}$	-	-	1300	
Diode forward voltage	V_{SD}	$V_{GS} = 0\text{ V}, I_F = 125\text{ A},$ $T_j = 25\text{ °C}$	-	0.8	1.1	V
Reverse recovery time ²⁾	t_{rr}	$V_R = 20\text{ V}, I_F = 50\text{ A},$ $di_F/dt = 100\text{ A}/\mu\text{s}$	-	60	-	ns
Reverse recovery charge ²⁾	Q_{rr}		-	73	-	nC

¹⁾ Current is limited by the overall system design and the customer-specific PCB.

²⁾ The parameter is not subject to production testing – specified by design.

³⁾ Current is limited by the package.

⁴⁾ Device on 2s2p FR4 PCB defined in accordance with JEDEC standards (JESD51-5, -7). PCB is vertical in still air.

Electrical characteristics diagrams

1 Power dissipation

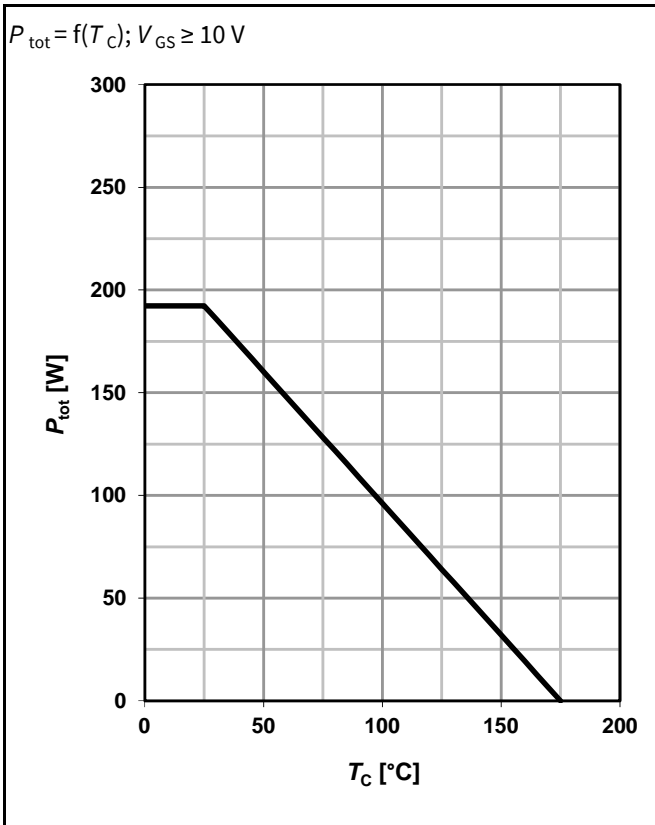

2 Drain current

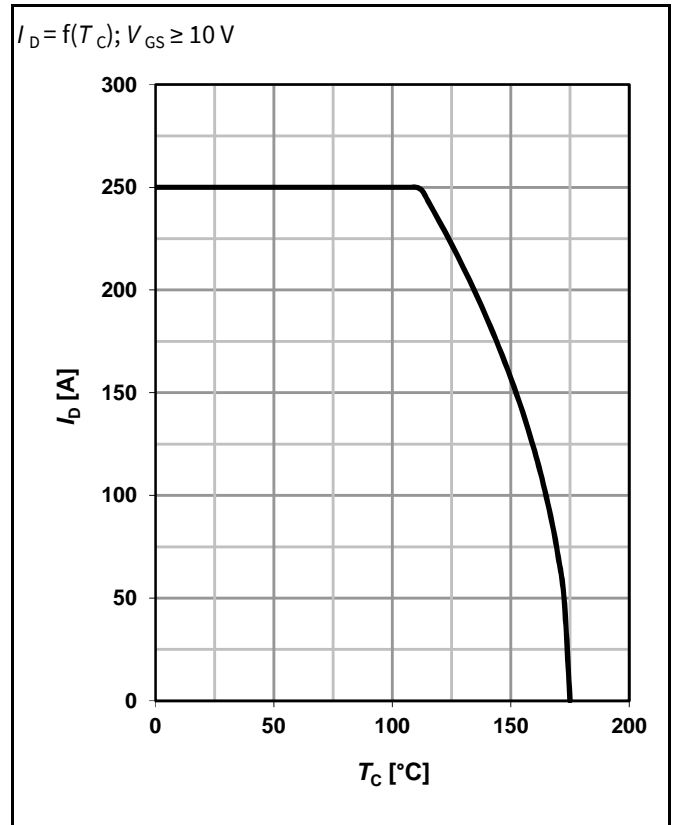

3 Safe operating area

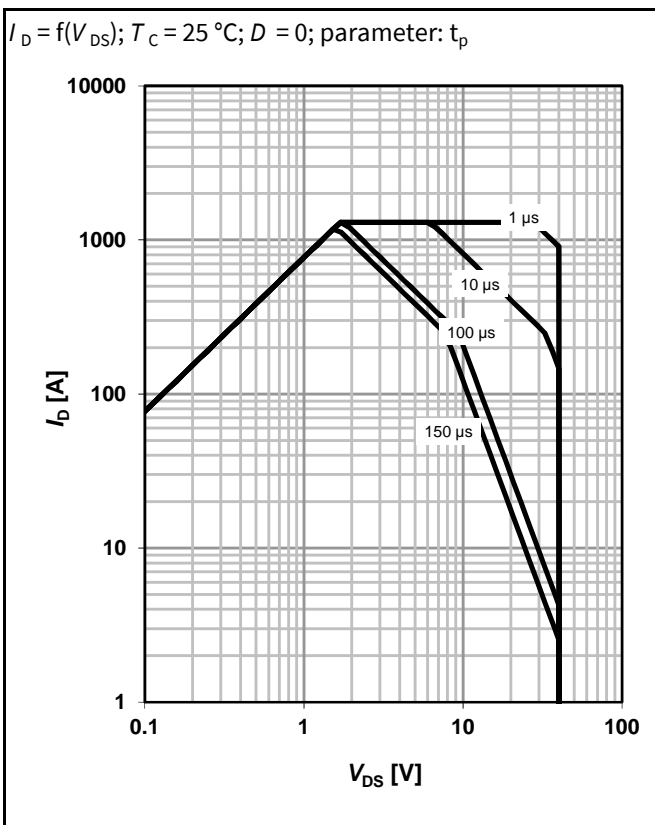

4 Max. transient thermal impedance

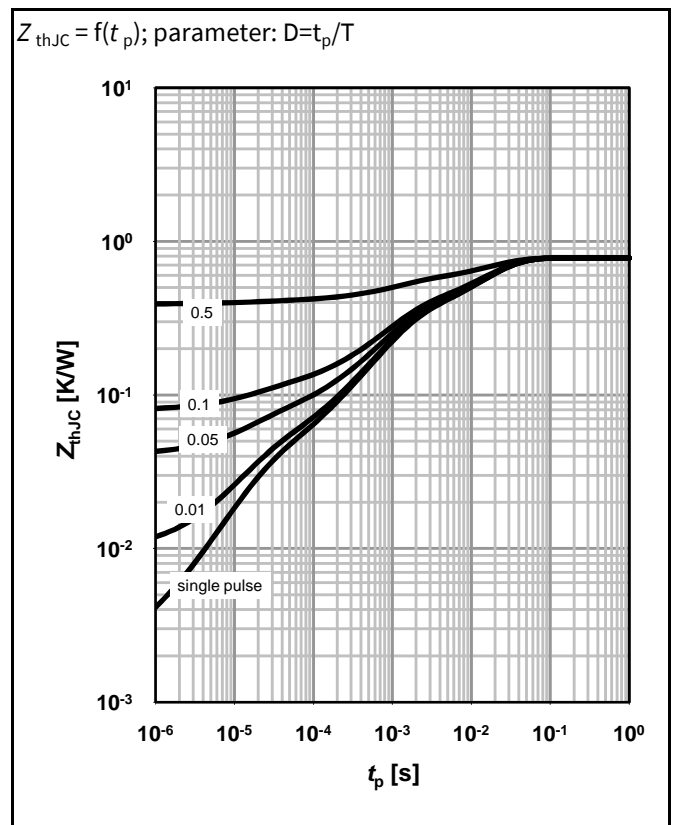

5 Typ. output characteristics

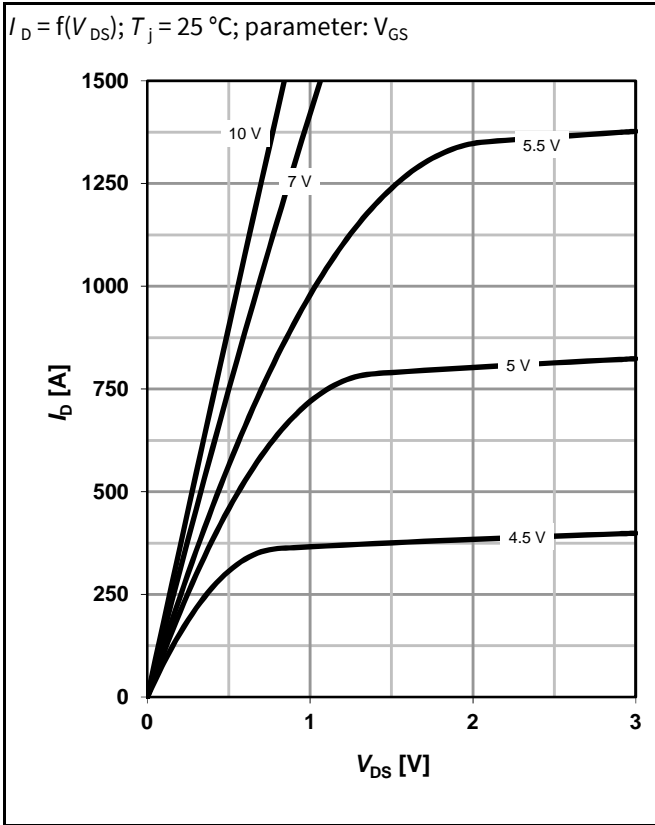

6 Typ. drain-source on-state resistance

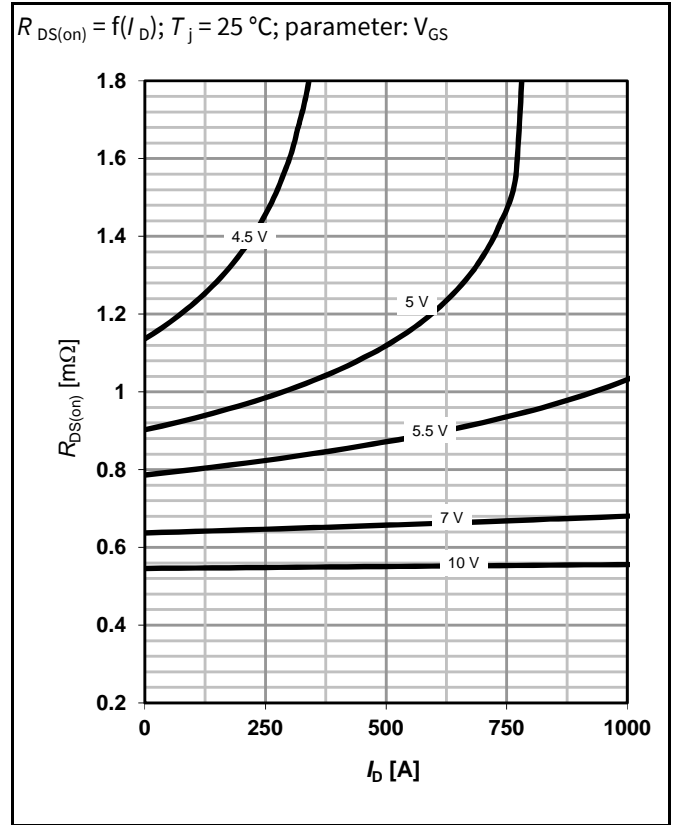

7 Typ. transfer characteristics

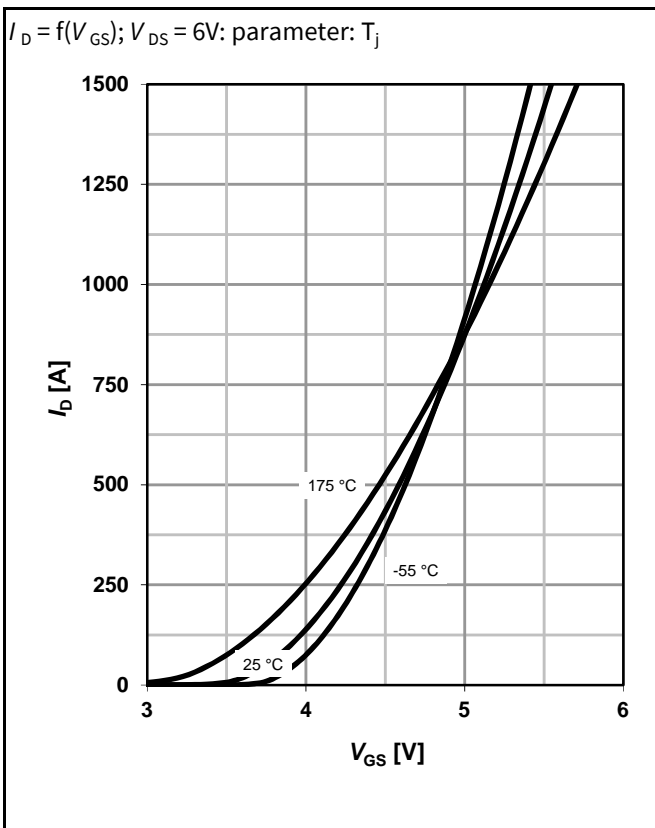

8 Typ. drain-source on-state resistance

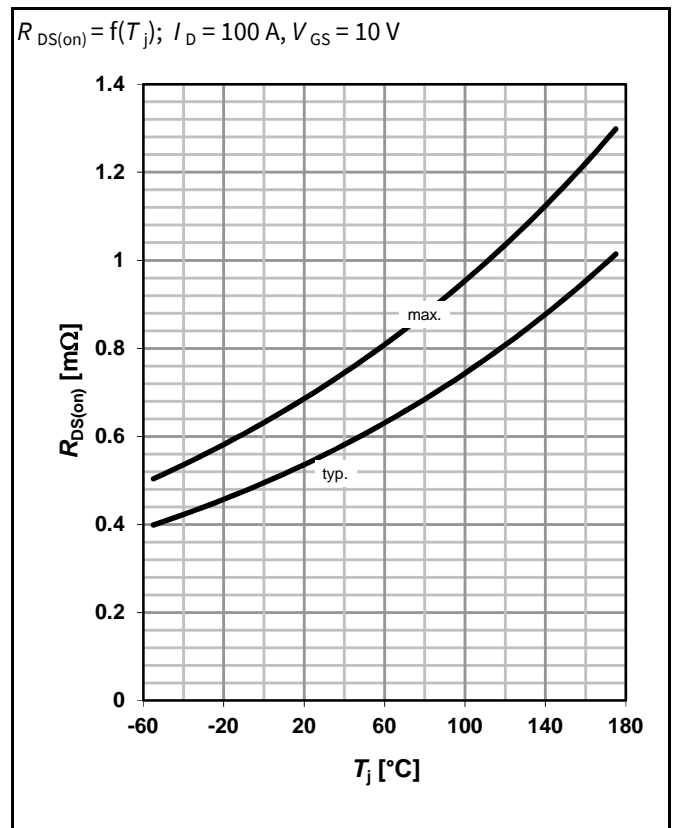

9 Typ. gate threshold voltage

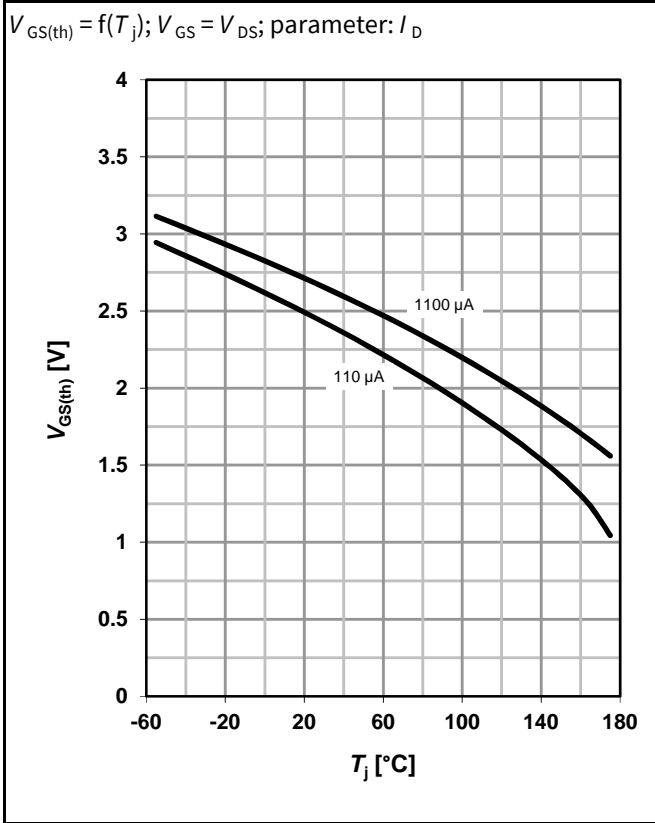

10 Typ. capacitances

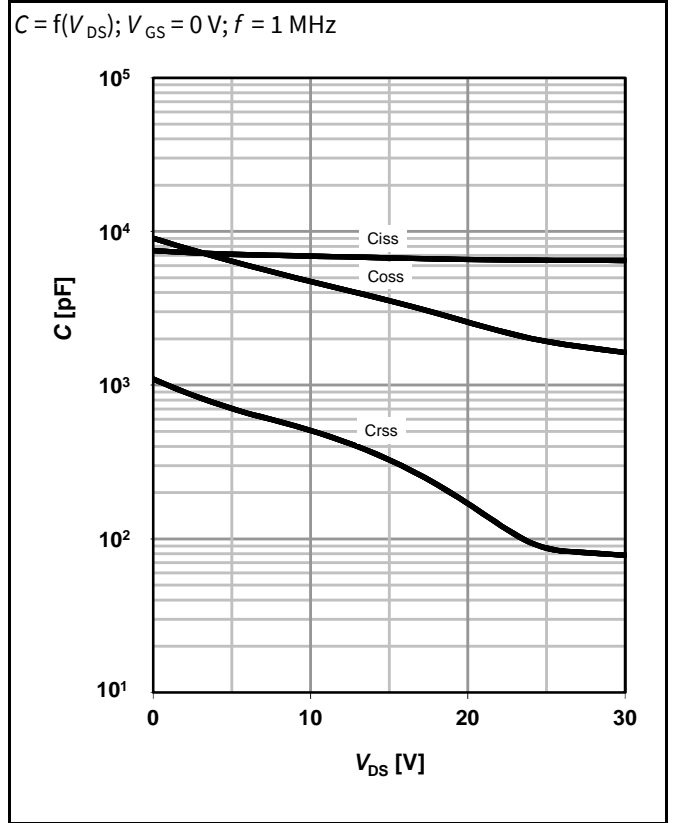

11 Typical forward diode characteristics

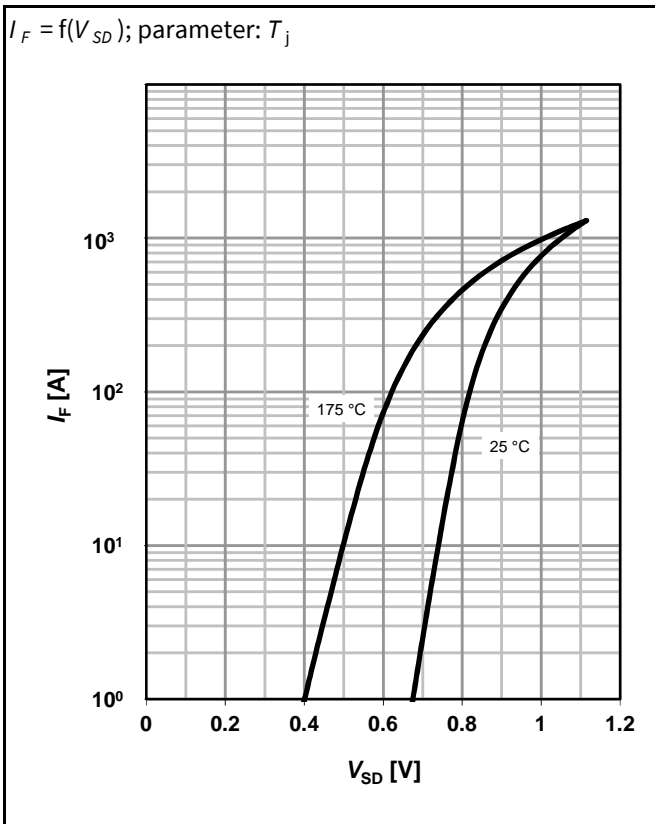

12 Typ. avalanche characteristics

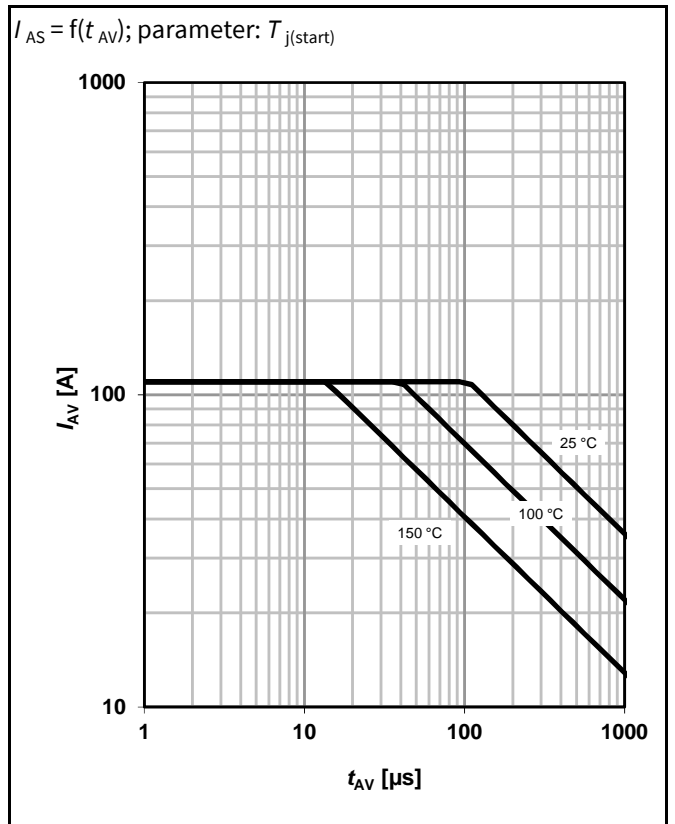

13 Typical avalanche energy

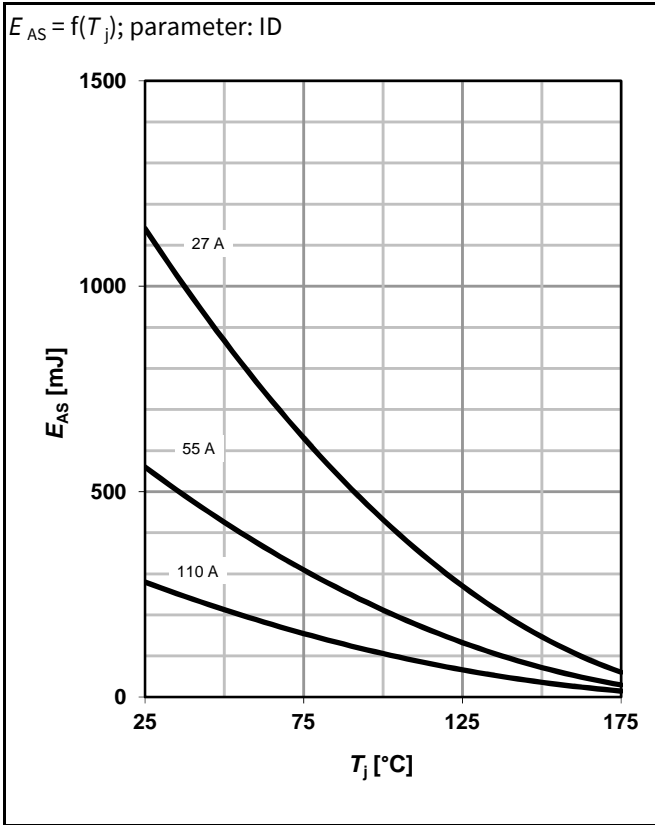

14 Drain-source breakdown voltage

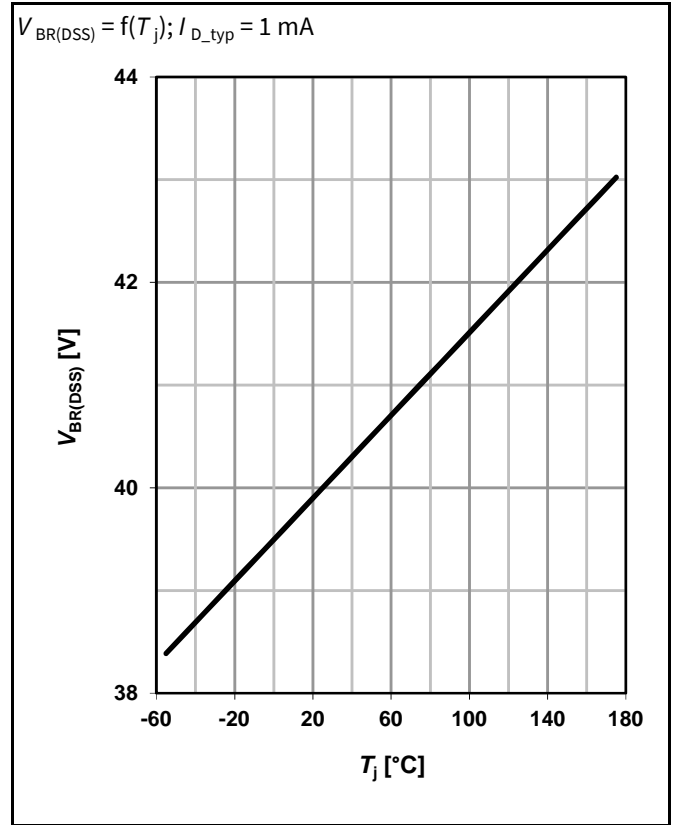

15 Typ. gate charge

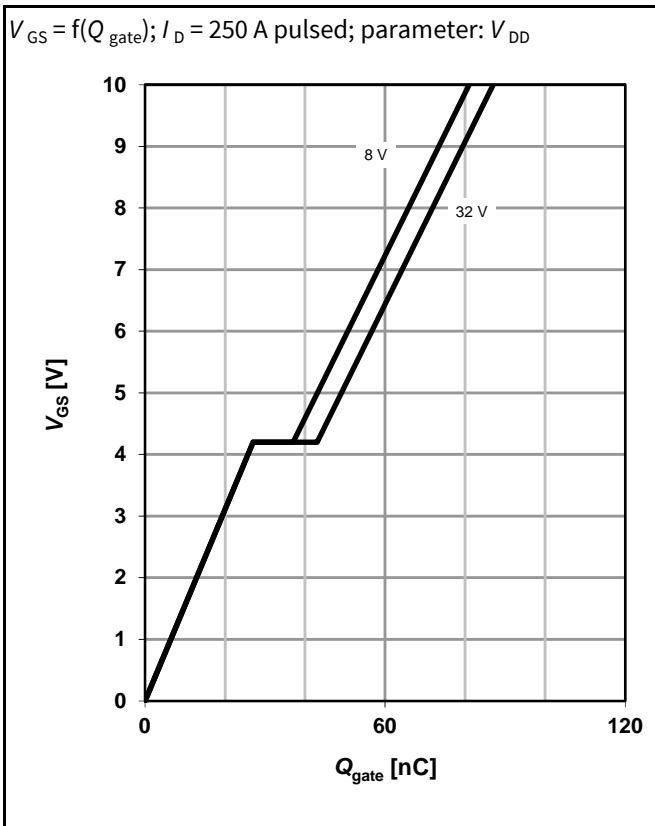

16 Gate charge waveforms

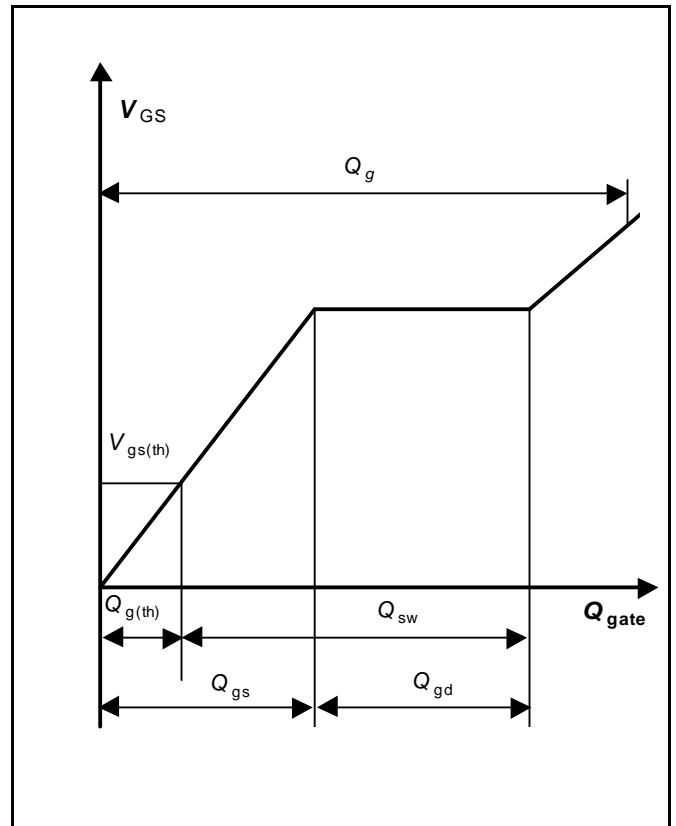

Package Outline

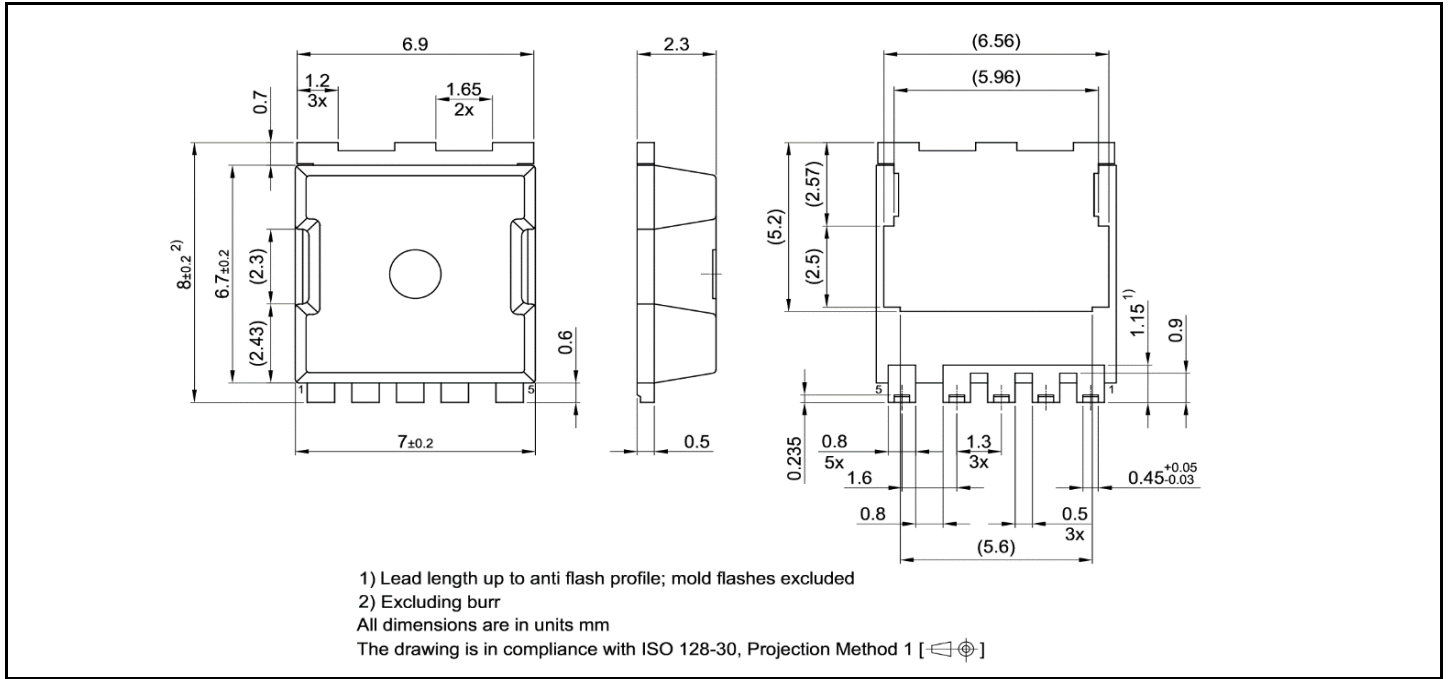

Footprint

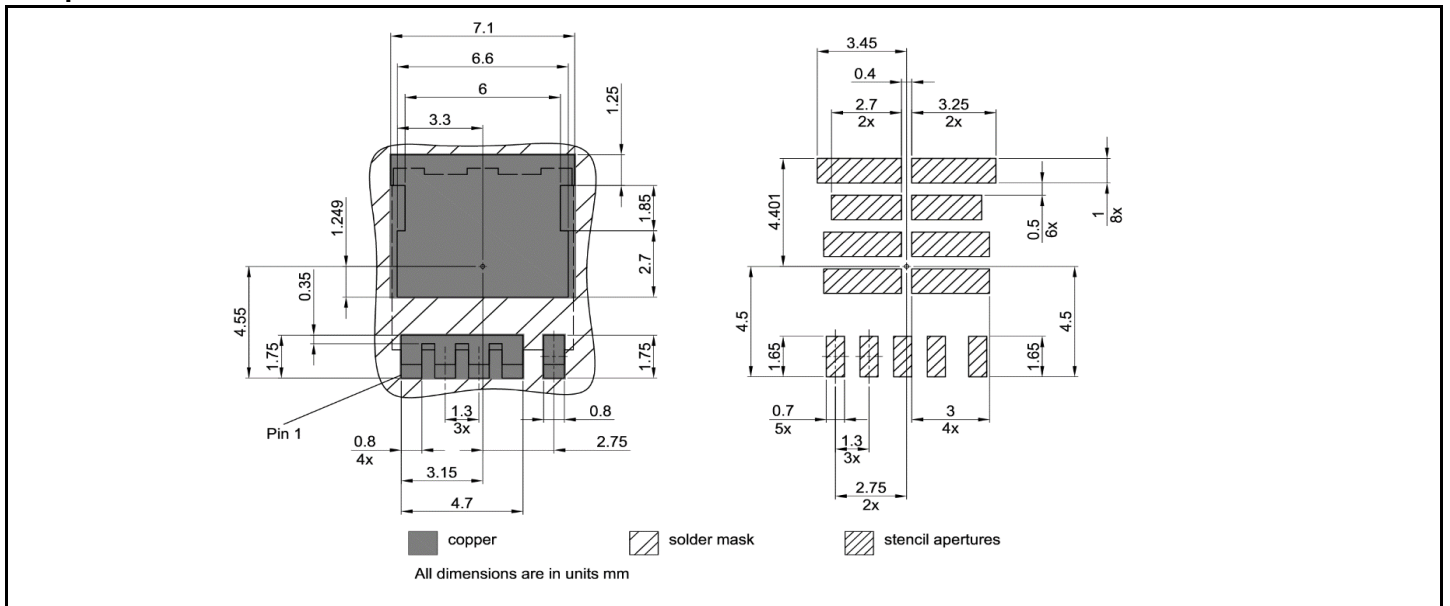

Packaging

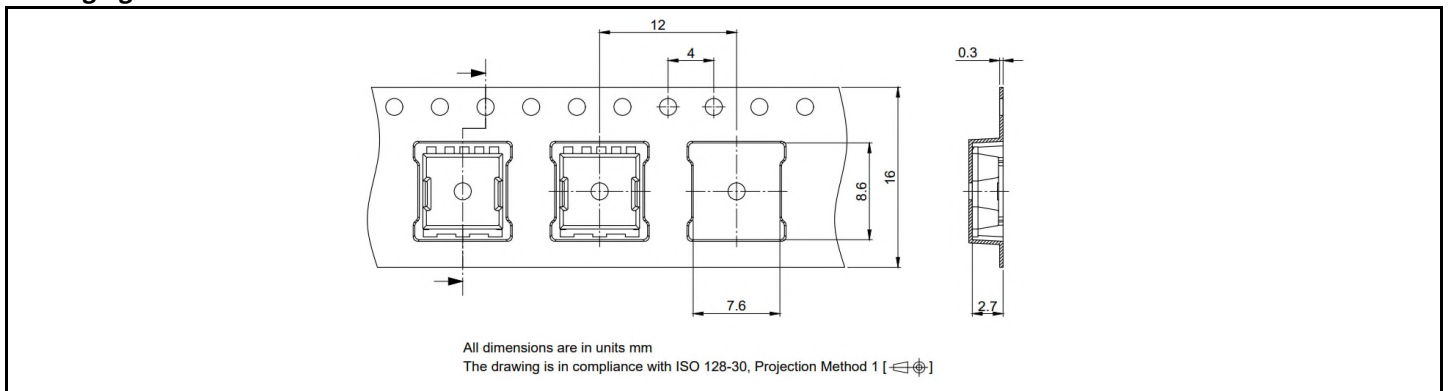



Revision History

Revision	Date	Changes
Revision 1.0	24.01.2022	Final Data Sheet

Trademarks

All referenced product or service names and trademarks are the property of their respective owners.

Edition 2022-01-24

Published by

Infineon Technologies AG

81726 Munich, Germany

© 2022 Infineon Technologies AG

All Rights Reserved.

Do you have any questions about any aspect of this document?

Email: erratum@infineon.com

IMPORTANT NOTICE

The information given in this document shall in no event be regarded as a guarantee of conditions or characteristics ("Beschaffenheitsgarantie").

With respect to any examples, hints or any typical values stated herein and/or any information regarding the application of the product, Infineon Technologies hereby disclaims any and all warranties and liabilities of any kind, including without limitation warranties of non-infringement of intellectual property rights of any third party.

In addition, any information given in this document is subject to customer's compliance with its obligations stated in this document and any applicable legal requirements, norms and standards concerning customer's products and any use of the product of Infineon Technologies in customer's applications. The data contained in this document is exclusively intended for technically trained staff. It is the responsibility of customer's technical departments to evaluate the suitability of the product for the intended application and the completeness of the product information given in this document with respect to such application.

For further information on technology, delivery terms and conditions and prices, please contact the nearest Infineon Technologies Office (www.infineon.com).



WARNINGS

Due to technical requirements products may contain dangerous substances. For information on the types in question please contact the nearest Infineon Technologies Office.

Except as otherwise explicitly approved by Infineon Technologies in a written document signed by authorized representatives of Infineon Technologies, Infineon Technologies' products may not be used in any applications where a failure of the product or any consequences of the use thereof can reasonably be expected to result in personal injury.

Looking for pricing, stock, or lifecycle information?

Click below to explore more details on WIN SOURCE:

-  [View IAUA250N04S6N007EAUMA1](#) on WIN SOURCE
-  [Infineon Technologies](#) Information

Optimize Your Supply Chain with WIN SOURCE Solutions

-  Global Sourcing Solution
-  Obsolete Management
-  Cost Control Management
-  Shortage Management
-  Alternative Solution
-  Excess Inventory Management