



**THE DATASHEET OF
REM10-0512S/A**



Features

Regulated Converter

- Reinforced insulation for 250VAC working voltage
- Clearance and creepage distance: 8mm
- 5kVAC I/P to O/P 2MOPP isolation
- 2µA patient leakage current
- Industry standard pinout
- 2:1 and 4:1 wide input range



REM10

10 Watt
2:1 & 4:1



DIP24
Single and Dual Output



IEC/EN60601-1 certified
CSA/CAN C22.2 60601-01 certified
ANSI/AAMI ES60601-1 certified
EN55011 certified

Description

The REM10 series of medical grade regulated DC/DC converters features reinforced 5kVAC/1 minute isolation with low 2µA leakage and are 60601-1 3rd Ed. certified for 250VAC continuous working. The compact DIP24 package offers tightly regulated single and dual outputs, even under no-load conditions. The outputs are short circuit and overload protected. The converters are available in two different pinning options and optionally with an external control pin for standby consumption as low as 12.5mW. The converters are fully certified to CB, IEC/EN and ANSI/AAMI standards and carry UL mark.

Selection Guide

Part Number	Input Voltage Range [VDC]	Output Voltage [VDC]	Output Current [mA]	Efficiency typ. [%]	Max. Capacitive Load [µF]
REM10-xx3.3S/ (3,4)	5 / 12 / 24 / 48	3.3	2500	80 / 83 / 83 / 82.5	3000
REM10-xx05S/ (3,4)	5 / 12 / 24 / 48	5	2000	84 / 85.5 / 86.5 / 86.5	2500
REM10-xx12S/ (3,4)	5 / 12 / 24 / 48	12	830	86.5 / 88 / 89 / 89	430
REM10-xx15S/ (3,4)	5 / 12 / 24 / 48	15	670	87 / 89 / 89 / 89	350
REM10-xx24S/ (3,4)	5 / 12 / 24 / 48	24	416	85.5 / 89 / 89 / 88.	125
REM10-xx05D/ (3,4)	5 / 12 / 24 / 48	±5	±1000	83 / 84 / 85 / 85	±1440
REM10-xx12D/ (3,4)	5 / 12 / 24 / 48	±12	±416	85.5 / 89 / 89 / 88	±250
REM10-xx15D/ (3,4)	5 / 12 / 24 / 48	±15	±333	86.5 / 88 / 89 / 88	±180
REM10-xx3.3SW/ (3,4)	24 / 48	3.3	2500	83 / 82.5	3000
REM10-xx05SW/ (3,4)	24 / 48	5	2000	86.5 / 86.5	2500
REM10-xx12SW/ (3,4)	24 / 48	12	830	89 / 89	430
REM10-xx15SW/ (3,4)	24 / 48	15	670	89 / 89	350
REM10-xx24SW/ (3,4)	24 / 48	24	416	89 / 88.5	125
REM10-xx05DW/ (3,4)	24 / 48	±5	±1000	85 / 85	±1440
REM10-xx12DW/ (3,4)	24 / 48	±12	±416	89 / 88	±250
REM10-xx15DW/ (3,4)	24 / 48	±15	±333	88 / 88	±180

Model Numbering

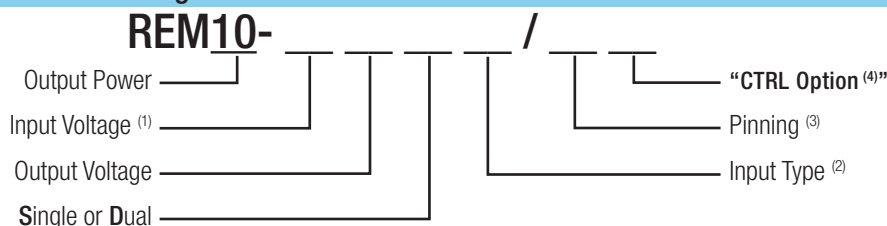

Notes:

Note1: for 4:1 Input Voltage Type add "W", see Note 2.

2:1	nom. Vin	4:1 "W"	nom. Vin
xx= 4.5-9Vin	= "05"	xx= 9-36Vin	= "24"
xx= 9-18Vin	= "12"	xx= 18-75Vin	= "48"
xx= 18-36Vin	= "24"		
xx= 36-75Vin	= "48"		

Note2: Blank for Standard 2:1 Input Voltage Range; „W" suffix for 4:1 Input Voltage Range

Note3: „A" suffix for A pinning; „C" suffix for C pinning, for more details refer to Package Style and Pinning

Note4: „CTRL" suffix for control pin option, for A pinning only, for C pinning not available

Examples:

REM10-0512D/A	=	2:1 Input, 4.5-9Vin, ±12Vout, pinout „A", without control pin
REM10-1215S/C	=	2:1 Input, 9-18Vin, 15Vout, pinout „C", without control pin
REM10-4815SW/A/CTRL	=	4:1 Input, 36-75Vin, 15Vout, pinout „A" with control pin
REM10-243.3SW/C	=	4:1 Input, 9-36Vin, 3.3Vout, pinout „C", without control pin

Specifications (measured @ Ta= 25°C, nominal input voltage, full load and after warm-up)

BASIC CHARACTERISTICS					
Parameter	Condition		Min.	Typ.	Max.
Absolute Maximum Input Voltage (3sec max.)	2:1 input	5Vin nom. 12Vin nom. 24Vin nom. 48Vin nom.			16VDC 25VDC 50VDC 100VDC
	4:1 input	24Vin nom. 48Vin nom.			50VDC 100VDC
Under Voltage Lockout	2:1 input	5Vin nom. 12Vin nom. 24Vin nom. 48Vin nom.	4VDC 8VDC 16VDC 33VDC		4.5VDC 9VDC 18VDC 36VDC
	4:1 input	24Vin nom. 48Vin nom.	8VDC 16VDC		9VDC 18VDC
Start-up Time	constant resistive load, Power up or Remote ON/OFF			30ms	
Remote ON/OFF (referenced to -Vin Pin)	DC-DC ON DC-DC OFF				Open or 0-1.2VDC 2.2-12VDC
Current of CTRL Pin			-0.5mA		1mA
Remote OFF Input Current				2.5mA	
Internal Operating Frequency			270kHz	300kHz	330kHz
Output Ripple and Noise (20MHz BW limited)	10µF/25V X7R MLCC for 3.3, 5Vout 10µF/25V X7R MLCC for 12, 15Vout 4.7µF/50V X7R MLCC for 24Vout			30mVp-p 40mVp-p 50mVp-p	

Efficiency vs. Load

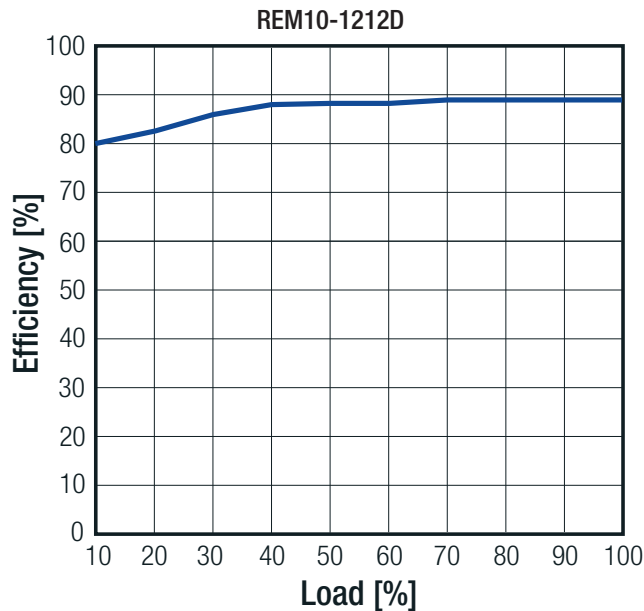

REGULATIONS

Parameter	Condition	Type	Value
Output Accuracy			±1.0%
Line Regulation	low line to high line	Single	±0.2%
		Dual	±0.5%
Load Regulation	no load to full load	Single	0.2%
		Dual	1.0%
Cross Regulation	asymmetrical load 25% / Full Load	only Dual Output	±5.0%
Transient Response	25% load step change		250µs

Specifications (measured @ Ta= 25°C, nominal input voltage, full load and after warm-up)

PROTECTIONS				
Parameter	Condition	Type	Value	
Short Circuit Protection (SCP)			continuous, auto-recovery	
Over Load Protection (OLP)	% of Iout rated		Hiccup mode, 150% typ.	
Output Over Voltage Protection (OVP)		Single	3.3Vout	3.7VDC min. / 5VDC max.
			5Vout	5.6VDC min. / 7VDC max.
			12Vout	13.5VDC min. / 16VDC max.
			15Vout	18.3VDC min. / 22VDC max.
		24Vout	29.1VDC min. / 34.5VDC max.	
		Dual	5Vout	5.6VDC min. / 7VDC max.
12Vout	13.5VDC min. / 18.2VDC max.			
15Vout	17VDC min. / 22VDC max.			
Isolation Voltage	I/P to O/P working voltage		5kVAC / 1 minute 250VAC / continuous	
Isolation Capacitance			12pF typ. / 17pF max.	
Leakage Current	240VAC, 60Hz		2µA	
Insulation Grade			reinforced	
Means of Protection			2MOPP	
Medical Device Classification			built-in power supply	
Internal Clearance and Creepage	I/P to O/P		≥8mm	
External Clearance and Creepage	I/P to O/P	"C" Pinning	>19.72mm	
		"A" Pinning	>14.64mm	

Notes:

Note5: This Power module is not internally fused. A input line fuse must be always used

Recommended Fuse:

2:1 Input Voltage	Fuse (slow blow)	4:1 Input Voltage	Fuse (slow blow)
5V	T5A	24V	T2A
12V	T2A	48V	T1A
24V	T1A		
48V	T0.5A		

ENVIRONMENTAL			
Parameter	Condition		Value
Maximum Case Temperature Range			-40°C to +105°C
Maximum Ambient Temperature Range			see "Thermal Calculation" below
Temperature Coefficient			0.02%/K typ.
Thermal Impedance	natural convection 0.1m/s		18K/W
Operating Altitude			5000m
Operating Humidity	non-condensing		5% - 95% RH max.
Pollution Degree			PD2
MTBF	according to MIL-HDBK-217F, G.B.	+25°C	3849 x 10 ³ hours
Thermal Shock			according to MIL-STD-810F standard
Vibration			according to MIL-STD-810F standard

continued on next page

Specifications (measured @ Ta= 25°C, nominal input voltage, full load and after warm-up)

Thermal Calculation

$$\eta_{set} = \eta_{full\ load} \times f_{\eta}$$

$$P_{diss} = \left[\frac{P_{out\ set}}{\eta_{set}} \right] - P_{out\ set}$$

$$T_{over} = R_{th} \times P_{diss}$$

$$T_{amb} = T_{case} - T_{over}$$

T_{case}	= baseplate temperature	[°C]
T_{over}	= temperature losses	[°C]
T_{amb}	= ambient temperature	[°C]
$P_{out\ nom.}$	= nom. output power	[W]
$P_{out\ set}$	= output power set	[W]
P_{diss}	= internal losses	[W]
R_{th}	= thermal impedance	[K/W]
η_{set}	= efficiency set	[%]
$\eta_{full\ load}$	= efficiency @ full load	[%]
f_{η}	= efficiency factor	[]

Efficiency Crosstable (%) @ full Load

		Input Voltage					
		5	12	24	48	24W	48W
Output Voltage	3.3S	80	83	83	82.5	83	82.5
	05S	84	85.5	86.5	86.5	86.5	86.5
	12S	86.5	88	89	89	89	89
	15S	87	89	89	89	89	89
	24S	85.5	89	89	88.5	89	88.5
	05D	83	84	85	85	85	85
	12D	85.5	89	89	88	89	88
	15D	86.5	88	88	88	88	88

Efficiency Factor vs. Load

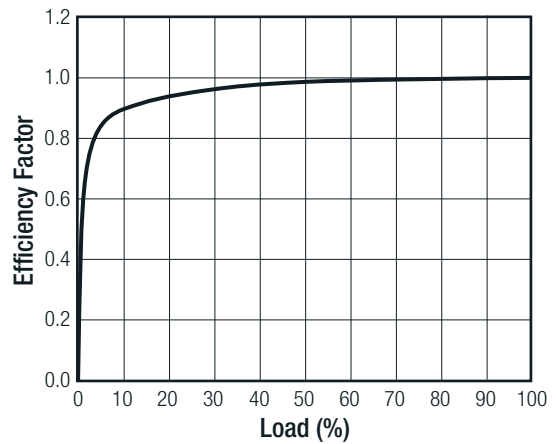

Practical Example:

Take the **REM10-1212D** with 12V Input Voltage, 50% load.
What is the maximum ambient operating temperature?

T_{case}	= 105°C
$P_{out\ nom.}$	= 10W
$P_{out\ set}$	= 10 x 0.5 = 5W
R_{th}	= 18K/W
$\eta_{full\ load}$	= 89% (Crosstable)
f_{η}	= 0.991 (Graph)

η_{set}	= 89 x 0.991 = 88.19%
P_{diss}	= $\left[\frac{5}{0.882} \right] - 5 =$ 0.67W
T_{over}	= 18 x 0.67 = +12.1°C
T_{amb}	= 105 - 12.1 = +92.9°C

SAFETY AND CERTIFICATIONS

Certificate Type (Safety)	Report / File Number	Standard
Medical Electric Equipment, General Requirements for Safety and Essential Performance	E314885-A6-CB-1	CAN/CSA-C22.2 No. 60601-1:08 ANSI/AAMI ES60601-1:2005
Medical Electric Equipment, General Requirements for Safety and Essential Performance (CB Scheme)	E314885-A6-CB-1	IEC60601-1:2005 + C2:2007 3rd Edition EN60601-1:2006
EAC	RU-AT.49.09571	TP TC 004/2011 TP TC 004/2011
RoHS2		RoHS-2011/65/EU + AM-2015/863

continued on next page

Specifications (measured @ Ta= 25°C, nominal input voltage, full load and after warm-up)

Certificate Type (Others)	Conditions	Standard / Criterion
Medical electrical equipment - Part 1-2: General requirements for basic safety and essential performance - Collateral standard: Electromagnetic compatibility - Requirements and tests		EN60601-1-2:2015
Industrial, scientific and medical equipment - Radio frequency disturbance characteristics - Limits and methods of measurement ⁽⁷⁾		EN55011:2009 + A1:2010 Class A & B
ESD Electrostatic discharge immunity test	Air ±15kV; Contact ±8kV	EN61000-4-2:2008
Radiated, radio-frequency, electromagnetic field immunity test	10V/m (80-2500MHz) 27V/m (385MHz) 28V/m (450MHz)	EN61000-4-3:2006 + A2:2010
Fast Transient and Burst Immunity ⁽⁶⁾	DC Port: ±2kV	EN61000-4-4:2012
Surge Immunity ⁽⁶⁾	DC Port: ±2kV	EN61000-4-5:2005
Immunity to conducted disturbances, induced by radio-frequency fields	6Vr.m.s	EN61000-4-6:2013
Power Frequency Magnetic Field	30A/m	EN61000-4-8:2009

Notes:

Note6: An external input filter capacitor is required if the model has to meet EN61000-4-4 or/and EN61000-4-5

Recommended components: 5Vin aluminum capacitor (Nippon Chemi-Con KY series, 1000µF/25V) and a reverse diode (Vishay V10P45) to connect in parallel
12Vin, 24Vin aluminum capacitor (Nippon Chemi-Con KY series, 470µF/50V)
48Vin aluminum capacitor (Nippon Chemi-Con KY series, 330µF/100V)

Note7: The whole REM10 series can meet EMI Class A with no external filter. And Class B only with external components

EMC Filter Suggestion for Class B ⁽⁸⁾

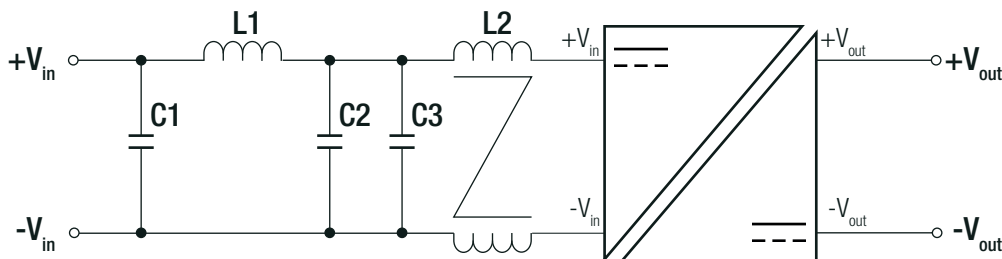

MODEL	C1 ⁽⁸⁾	C2 ⁽⁸⁾	C3 ⁽⁸⁾	L1 ⁽⁸⁾	L2 ⁽⁸⁾
REM10-05xxS_D	N/A	22µF/16V MLCC	22µF/16V MLCC	3.3µH; 3.3A SMD Inductor	52µH CMC
REM10-12xxS_D REM10-24xxS_D(W)	4.7µF/50V MLCC	4.7µF/50V MLCC	N/A	10µH; 2.3A SMD Inductor	175µH CMC
REM10-48xxS_D(W)	1µF/100V MLCC	4.7µF/100V MLCC	N/A	10µH; 2.3A SMD Inductor	419µH CMC

Notes:

Note8: The component values can be adapted according to customer's application

DIMENSION and PHYSICAL CHARACTERISTICS

Parameter	Type	Value
Material	case	non-conductive black plastic (UL94-V2)
	PCB	FR4 (UL94-V1)
	potting	silicone (UL94-V0)
Dimension (LxWxH)		31.80 x 20.30 x 10.40mm
Weight		14g

continued on next page

Specifications (measured @ Ta= 25°C, nominal input voltage, full load and after warm-up)

Dimension Drawing (mm)

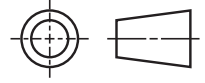

“A” Pinning (Standard)

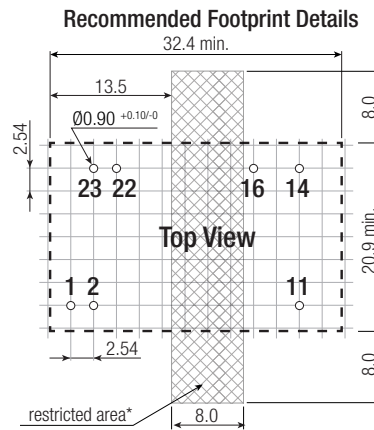
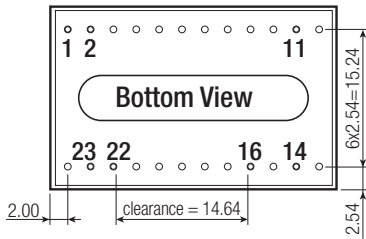
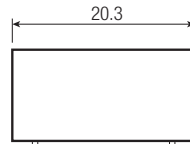
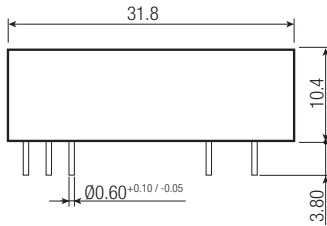
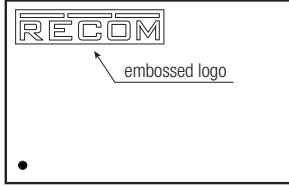

Pin Connections

Pin #	Single	Dual
1	CTRL*	CTRL*
2	-Vin	-Vin
11	NC	-Vout
14	+Vout	+Vout
16	-Vout	Com
22	+Vin	+Vin
23	+Vin	+Vin

* If the CTRL option is not chosen, Pin 1 will be absent

NC= not connected
Tolerance: xx.x= ±0.5mm
xx.xx=±0.25mm

*A minimum of 8mm clearance and creepage is required between primary and secondary circuit to meet 2MOPP under IEC60601-1. No copper traces and/or components are allowed in this area if 2MOPP is required.

“C” Pinning

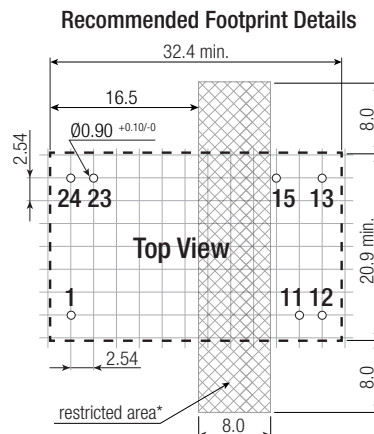
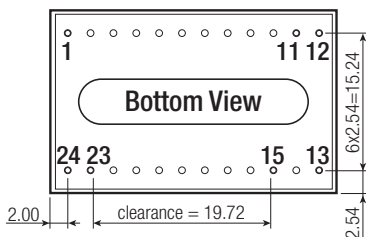
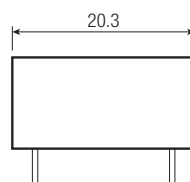
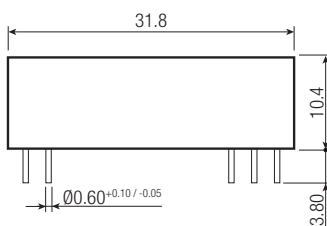
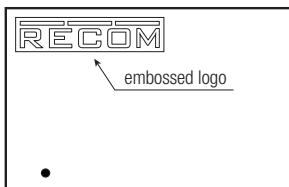

Pin Connections

Pin #	Single	Dual
1	+Vin	+Vin
11	No Pin	Com
12	-Vout	No Pin
13	+Vout	-Vout
15	No Pin	+Vout
23	-Vin	-Vin
24	-Vin	-Vin

Tolerance: xx.x= ±0.5mm
xx.xx= ±0.25mm

*A minimum of 8mm clearance and creepage is required between primary and secondary circuit to meet 2MOPP under IEC60601-1. No copper traces and/or components are allowed in this area if 2MOPP is required.

Specifications (measured @ Ta= 25°C, nominal input voltage, full load and after warm-up)

PACKAGING INFORMATION

Parameter	Type	Value
Packaging Dimension (LxWxH)	tube	255 x 21.8 x 16.5mm
Packaging Quantity		7pcs
Storage Temperature Range		-55°C to +125°C
Storage Humidity	non-condensing	5% to 95% RH max.

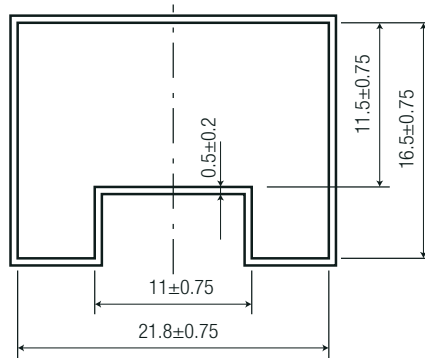

Tube Dimension Drawing (mm)



The product information and specifications may be subject to changes even without prior written notice. The product has been designed for various applications; its suitability lies in the responsibility of each customer. The products are not authorized for use in safety-critical applications without RECOM's explicit written consent. A safety-critical application is an application where a failure may reasonably be expected to endanger or cause loss of life, inflict bodily harm or damage property. The applicant shall indemnify and hold harmless RECOM, its affiliated companies and its representatives against any damage claims in connection with the unauthorized use of RECOM products in such safety-critical applications.

Looking for pricing, stock, or lifecycle information?

Click below to explore more details on WIN SOURCE:

-  [View REM10-0512S/A on WIN SOURCE](#)
-  [Recom Power Information](#)

Optimize Your Supply Chain with WIN SOURCE Solutions

-  Global Sourcing Solution
-  Obsolete Management
-  Cost Control Management
-  Shortage Management
-  Alternative Solution
-  Excess Inventory Management