



**THE DATASHEET OF
TYETBCSANF-50.000000**



TY Type

2.5 x 2.0 mm SMD Voltage Controlled Temperature Compensated Crystal Oscillator

FEATURE

- Conforms to AEC-Q200
- Typical 2.5 x 2.0 x 0.7 mm ceramic SMD package.
- For automatic assembly.
- Compactness and lightweight.
- VCTCXO available.
- Low thickness

TYPICAL APPLICATION

- GPS
- WiMAX, WLAN
- Mobile Phone

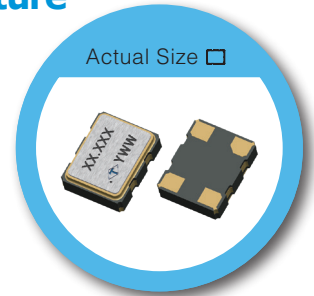

RoHS Compliant

DIMENSION (mm)

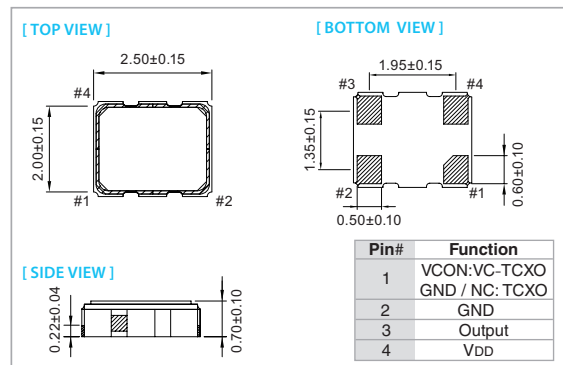

SOLDER PAD LAYOUT (mm)

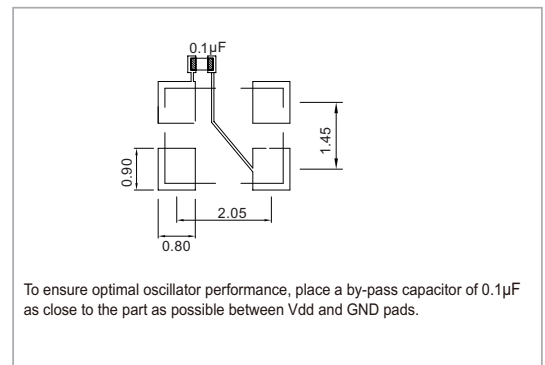

ELECTRICAL SPECIFICATION

Parameter	3.3 / 3.0 / 2.8 V		2.5 V		1.8 V		Unit
	Min.	Max.	Min.	Max.	Min.	Max.	
Supply Voltage Variation (VDD)	2.66	3.465	2.375	2.625	1.71	1.89	V
Frequency Range	10	52	10	52	10	52	MHz
Standard Frequency	16.369, 19.2, 26.0, 38.4						
Frequency Tolerance*	-	±2.0	-	±2.0	-	±2.0	ppm
Frequency stability							ppm
Vs Supply Voltage (±5%) change	-	±0.2	-	±0.2	-	±0.2	
Vs Load (±10%) change	-	±0.2	-	±0.2	-	±0.2	
Vs Aging (@ 1st year)	-	±1.0	-	±1.0	-	±1.0	ppm
Supply Current	10 MHz ≤ Fo ≤ 26 MHz		26 MHz < Fo ≤ 52 MHz				mA
	-	1.5	-	1.5	-	1.5	
	-	2.0	-	2.0	-	2.0	
Output Level (Clipped sine wave)	0.8	-	0.8	-	0.8	-	Vp-p
Load	10 KΩ // 10pF		10 KΩ // 10pF		10 KΩ // 10pF		
Control Voltage Range (VCTCXO)	0.5	2.5	0.4	2.4	0.3	1.5	V
Pulling Range (VCTCXO)	±5.0	-	±5.0	-	±5.0	-	ppm
Vc Input Impedance (VCTCXO)	500	-	500	-	500	-	kΩ
Phase Noise @ 19.2 MHz	100 Hz		1 kHz		10 kHz		dBc/Hz
	-115		-115		-115		
	-135		-135		-135		
	-148		-148		-148		
Start time	-	2	-	2	-	2	mSec
Storage Temp. Range	-55	125	-55	125	-55	125	°C

Standard frequencies are frequencies which the crystal has been designed and does not imply a stock position.

* Frequency at 25°C, 1 hour after reflow.

FREQ. STABILITY vs. TEMP. RANGE

Temp. (°C)	ppm				
	±0.5	±1.0	±1.5	±2.0	±2.5
-20 ~ +70	○	○	○	○	○
-30 ~ +85	○	○	○	○	○
-40 ~ +85	○	○	○	○	○

* ○: Available △: Conditional X: Not available

Note: not all combination of options are available. Other specifications may be available upon request.







Looking for pricing, stock, or lifecycle information?

Click below to explore more details on WIN SOURCE:

 [View TYETBCSANF-50.000000 on WIN SOURCE](#)

 [Taitien](#) Information

Optimize Your Supply Chain with WIN SOURCE Solutions

-  Global Sourcing Solution
-  Obsolete Management
-  Cost Control Management
-  Shortage Management
-  Alternative Solution
-  Excess Inventory Management