



**THE DATASHEET OF  
VS-FC270SA20**



## SOT-227 Power Module Single Switch - Power MOSFET, 270 A



SOT-227

**FEATURES**

- $I_D = 287\text{ A}$ ,  $T_C = 25\text{ °C}$
- ThunderFET power MOSFET
- Reduced switching and conduction losses
- Maximum  $175\text{ °C}$  junction temperature
- UL approved file E78996 
- Material categorization: for definitions of compliance please see [www.vishay.com/doc?99912](http://www.vishay.com/doc?99912)

**RoHS  
COMPLIANT**
**PRIMARY CHARACTERISTICS**

$V_{DSS}$	200 V
$R_{DS(on)}$	3.3 m $\Omega$
$I_D$	219 A at 90 °C
Type	Modules - MOSFET
Package	SOT-227

**APPLICATIONS**

- DC/DC conversions
- Motor drives switch
- DC/AC inverter
- Power supplies
  - Uninterruptible power supplies
  - AC/DC switchmode power supplies
  - Solar micro inverter

**ABSOLUTE MAXIMUM RATINGS**

PARAMETER	SYMBOL	TEST CONDITIONS	MAX.	UNITS
<b>MOSFET</b>				
Drain to source voltage	$V_{DSS}$		200	V
Continuous drain current, $V_{GS}$ at 10 V	$I_D$	$T_C = 25\text{ °C}$	287	A
		$T_C = 90\text{ °C}$	219	
Pulsed drain current	$I_{DM}^{(1)}$		680	
Power dissipation	$P_D$	$T_C = 25\text{ °C}$	937	W
Gate to source voltage	$V_{GS}$		$\pm 20$	V
Single pulse avalanche energy <sup>(2)</sup>	$E_{AS}$	$T_C = 25\text{ °C}$ , $L = 0.1\text{ mH}$ , $V_{GS} = 10\text{ V}$	650	mJ
Avalanche current	$I_{AS}$		180	A
<b>MODULE</b>				
Operating junction temperature range	$T_J$		-55 to +175	°C
Operating storage temperature range	$T_{Stg}$		-40 to +150	
Insulation voltage (RMS)	$V_{ISOL}$	Any terminal to case, $t = 1\text{ min}$	2500	V

**Notes**
<sup>(1)</sup> Limited at max. junction temperature

<sup>(2)</sup> Duty cycle  $\leq 1\%$



THERMAL - MECHANICAL SPECIFICATIONS						
PARAMETER	SYMBOL	TEST CONDITIONS	MIN.	TYP.	MAX.	UNITS
Operating junction temperature range	$T_J$		-55	-	175	°C
Operating storage temperature range	$T_{Stg}$		-40	-	150	
Junction to case	MOSFET	$R_{thJC}$	-	-	0.16	°C/W
Case to heatsink	Module	$R_{thCS}$	Flat, greased surface	0.1	-	
Weight			-	30	-	g
Mounting torque		Torque to terminal	-	-	1.1 (9.7)	Nm (lbf. in)
		Torque to heatsink	-	-	1.8 (15.9)	Nm (lbf. in)
Case style			SOT-227			

ELECTRICAL CHARACTERISTICS ( $T_J = 25\text{ }^\circ\text{C}$ unless otherwise specified)						
PARAMETER	SYMBOL	TEST CONDITIONS	MIN.	TYP.	MAX.	UNITS
Drain to source breakdown voltage	$V_{(BR)DSS}$	$V_{GS} = 0\text{ V}, I_D = 1.0\text{ mA}$	200	-	-	V
Breakdown voltage temperature coefficient	$\Delta V_{(BR)DSS}/\Delta T_J$	Reference to $25\text{ }^\circ\text{C}, I_D = 1.0\text{ mA}$	-	0.16	-	V/°C
Static drain to source on-resistance	$R_{DS(on)}$	$V_{GS} = 10\text{ V}, I_D = 200\text{ A}$	-	3.3	4.7	mΩ
Gate threshold voltage	$V_{GS(th)}$	$V_{DS} = V_{GS}, I_D = 1.0\text{ mA}$	1.8	3.16	4.3	V
Forward transconductance	$g_{fs}$	$V_{DS} = 15\text{ V}, I_D = 100\text{ A}, V_{GS} = 10\text{ V}$	-	270	-	S
Drain to source leakage current	$I_{DSS}$	$V_{DS} = 200\text{ V}, V_{GS} = 0\text{ V}$	-	0.5	10	μA
		$V_{DS} = 200\text{ V}, V_{GS} = 0\text{ V}, T_J = 150\text{ }^\circ\text{C}$	-	160	-	
Gate to source leakage	$I_{GSS}$	$V_{GS} = \pm 20\text{ V}$	-	-	± 200	nA
Total gate charge	$Q_g$	$I_D = 120\text{ A}$ $V_{DS} = 100\text{ V}$ $V_{GS} = 10\text{ V}$	-	250	-	nC
Gate to source charge	$Q_{gs}$		-	68	-	
Gate to drain ("Miller") charge	$Q_{gd}$		-	70	-	
Turn-on delay time	$t_{d(on)}$	$V_{DD} = 100\text{ V}$ $I_D = 100\text{ A}$ $R_g = 1\text{ }^\Omega$ $V_{GS} = 10\text{ V}$	-	76	-	ns
Rise time	$t_r$		-	212	-	
Turn-off delay time	$t_{d(off)}$		-	134	-	
Fall time	$t_f$		-	118	-	
Input capacitance	$C_{iss}$	$V_{GS} = 0\text{ V}$ $V_{DS} = 100\text{ V}$ $f = 1\text{ MHz}$	-	16.5	-	nF
Output capacitance	$C_{oss}$		-	1.0	-	
Reverse transfer capacitance	$C_{rss}$		-	0.8	-	
Temperature coefficient of threshold voltage	$\Delta V_{GE(th)}/\Delta T_J$	$V_{DS} = V_{GS}, I_D = 1.0\text{ mA}$ ( $25\text{ }^\circ\text{C}$ to $125\text{ }^\circ\text{C}$ )	-	9.2	-	mV/°

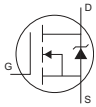
SOURCE-DRAIN RATINGS AND CHARACTERISTICS ( $T_J = 25\text{ }^\circ\text{C}$ unless otherwise specified)						
PARAMETER	SYMBOL	TEST CONDITIONS	MIN.	TYP.	MAX.	UNITS
Continuous source current (body diode)	$I_S$		-	-	287	A
Pulsed source current (body diode)	$I_{SM}$	MOSFET symbol showing the integral reverse p-n junction diode 	-	-	680	
Diode forward voltage	$V_{SD}$	$I_S = 200\text{ A}, V_{GS} = 0\text{ V}$	-	0.93	1.23	V
Reverse recovery time	$t_{rr}$	$T_J = 25\text{ }^\circ\text{C}, I_F = I_S = 50\text{ A},$ $di/dt = 100\text{ A}/\mu\text{s}, V_R = 100\text{ V}$	-	210	-	ns
Reverse recovery charge	$Q_{rr}$		-	1646	-	nC
Reverse recovery current	$I_{RM}$		-	15.7	-	A

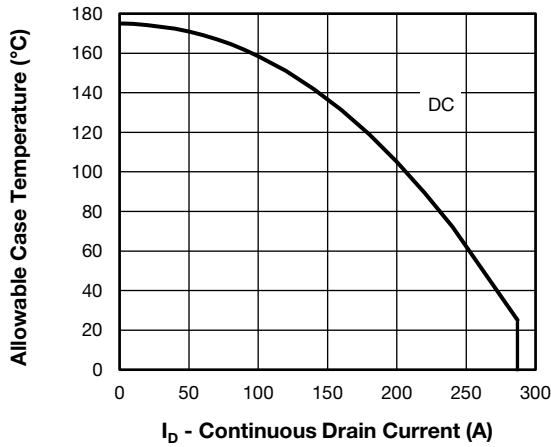

Fig. 1 - Maximum Continuous Drain Current vs. Case Temperature

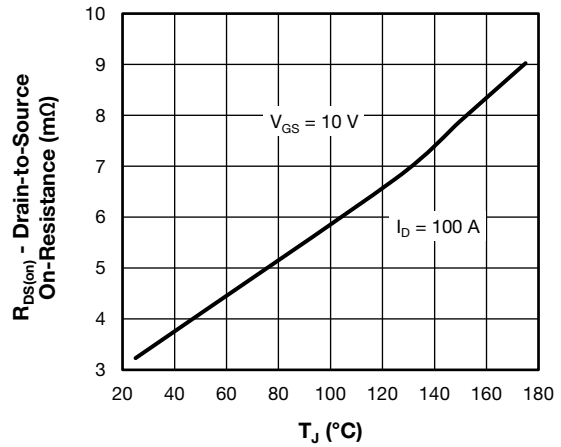

Fig. 4 - Typical Drain-to-Source On-Resistance vs. Temperature

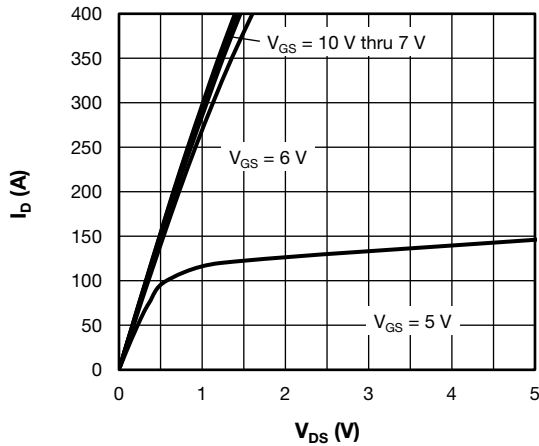

Fig. 2 - Typical Drain to Source Current Output Characteristics at  $T_J = 125^\circ\text{C}$

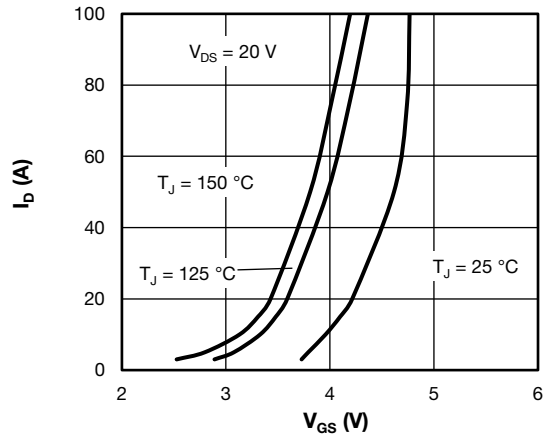

Fig. 5 - Typical Transfer Characteristics

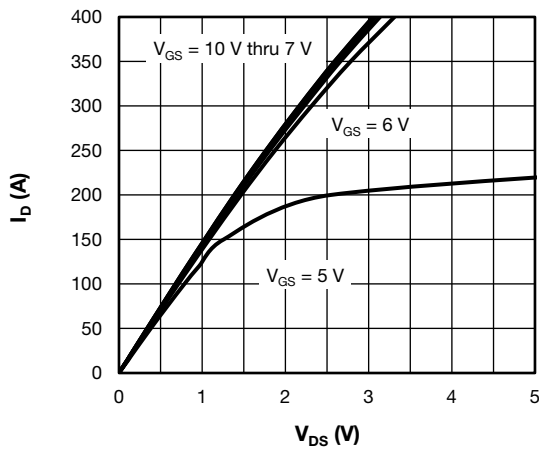

Fig. 3 - Typical Drain to Source Current Output Characteristics at  $T_J = 125^\circ\text{C}$

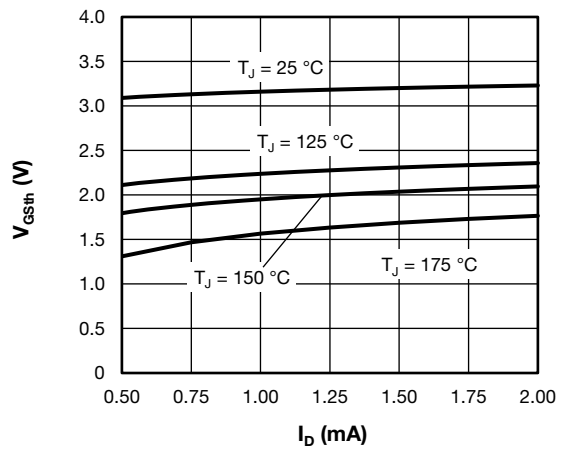

Fig. 6 - Typical Gate Threshold Voltage Characteristics

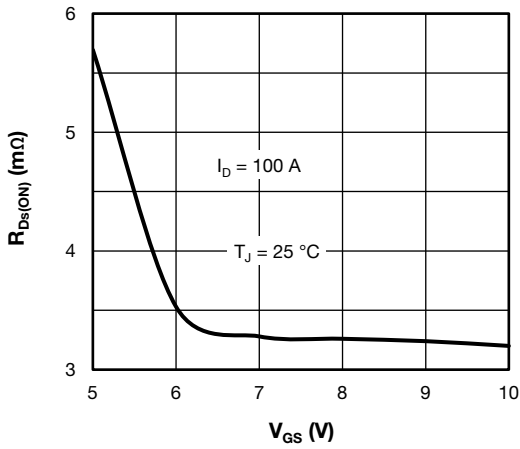

Fig. 7 - Typical Drain - State Resistance vs. Gate to Source Voltage

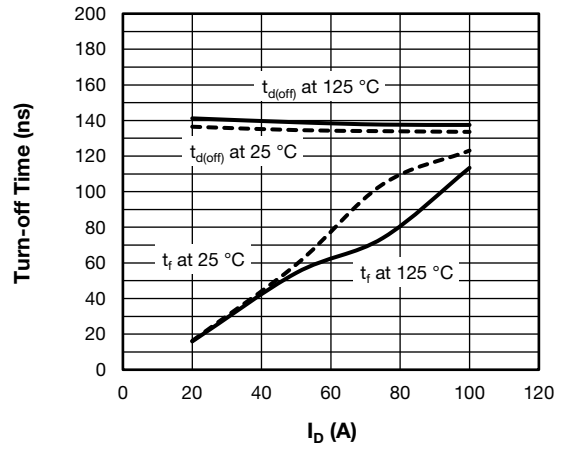

Fig. 10 - Typical Turn-Off Switching Time vs.  $I_D$ ,  $V_{DD} = 100\text{ V}$ ,  $R_g = 1.0\ \Omega$ ,  $V_{GS} = \pm 10\text{ V}$ ,  $L = 500\ \mu\text{H}$

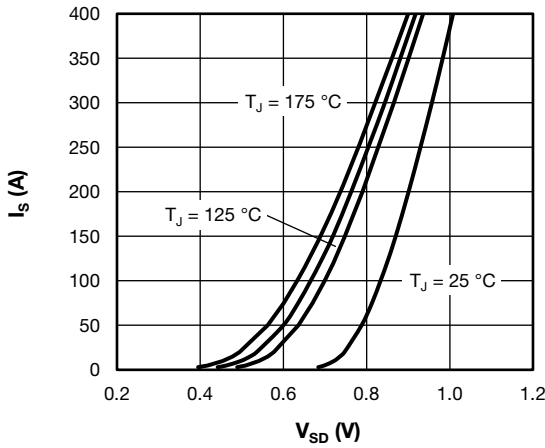

Fig. 8 - Typical Body Diode Source-to-Drain Current Characteristics

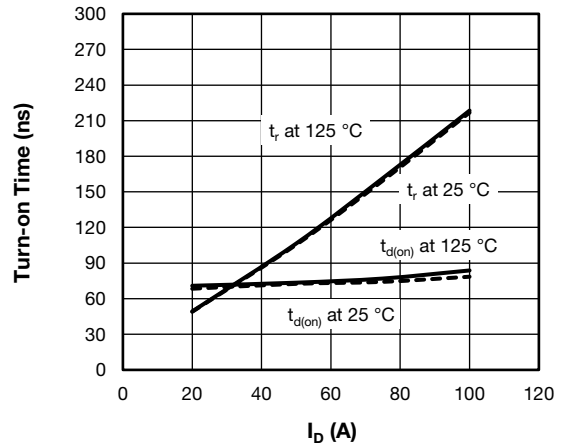

Fig. 11 - Typical Turn-On Switching Time vs.  $I_D$ ,  $V_{DD} = 100\text{ V}$ ,  $R_g = 1.0\ \Omega$ ,  $V_{GS} = \pm 10\text{ V}$ ,  $L = 500\ \mu\text{H}$

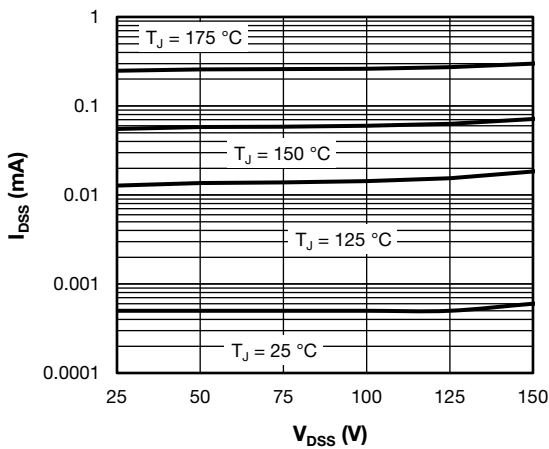

Fig. 9 - Typical Zero Gate Voltage Drain Current

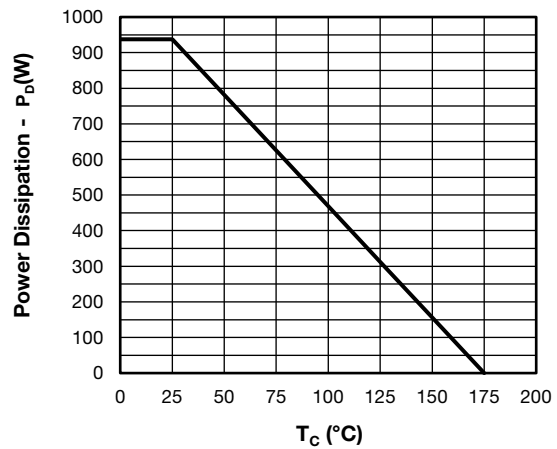

Fig. 12 - Power Dissipation Curve

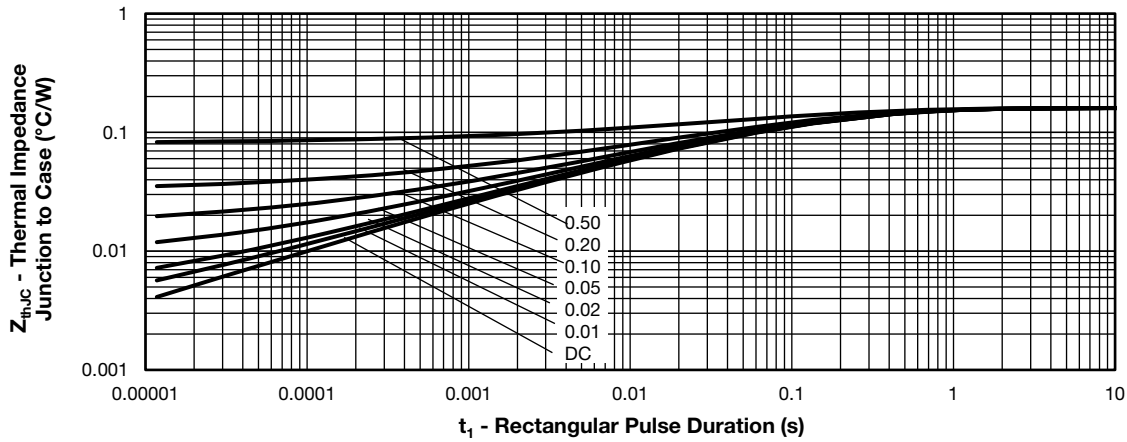

Fig. 13 - Maximum Thermal Impedance Junction-to-Case Characteristics

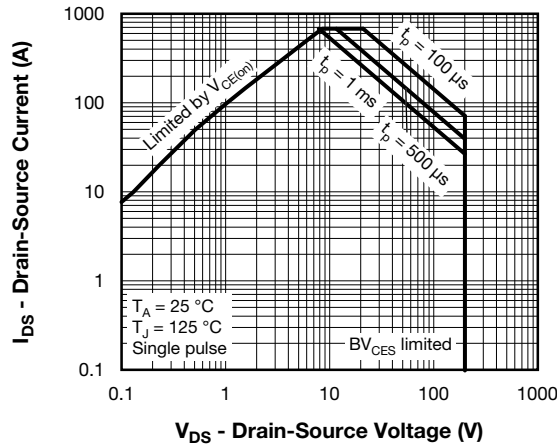

Fig. 14 - Safe Operating Area

**ORDERING INFORMATION TABLE**

Device code	<b>VS-</b>	<b>F</b>	<b>C</b>	<b>270</b>	<b>S</b>	<b>A</b>	<b>20</b>
	①	②	③	④	⑤	⑥	⑦

- 1** - Vishay Semiconductors product
- 2** - MOSFET module
- 3** - MOSFET die generation
- 4** - Current rating (270 = 270 A)
- 5** - Circuit configuration (S = single switch)
- 6** - Package indicator (SOT-227)
- 7** - Voltage rating (20 = 200 V)

CIRCUIT CONFIGURATION		
CIRCUIT	CIRCUIT CONFIGURATION CODE	CIRCUIT DRAWING
Single switch	S	

**DIMENSIONS** in millimeters

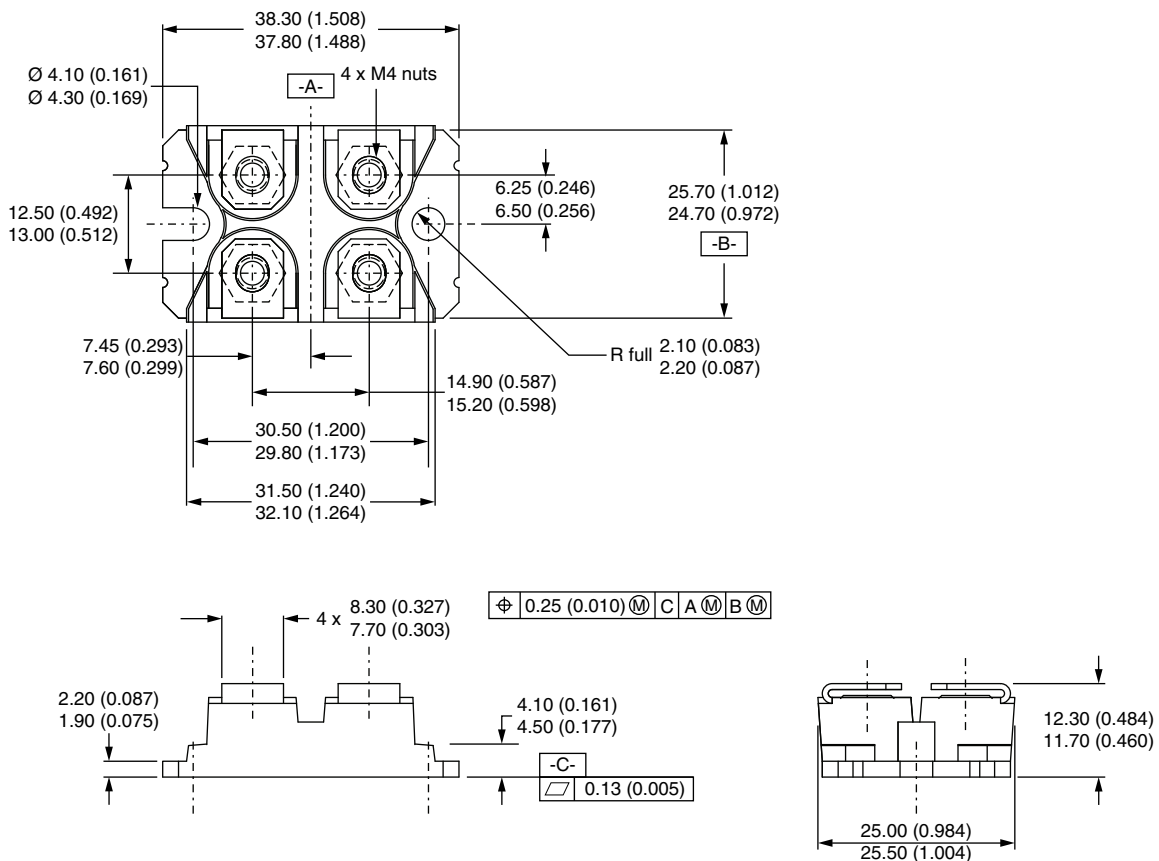



## SOT-227 Generation 2

**DIMENSIONS** in millimeters (inches)

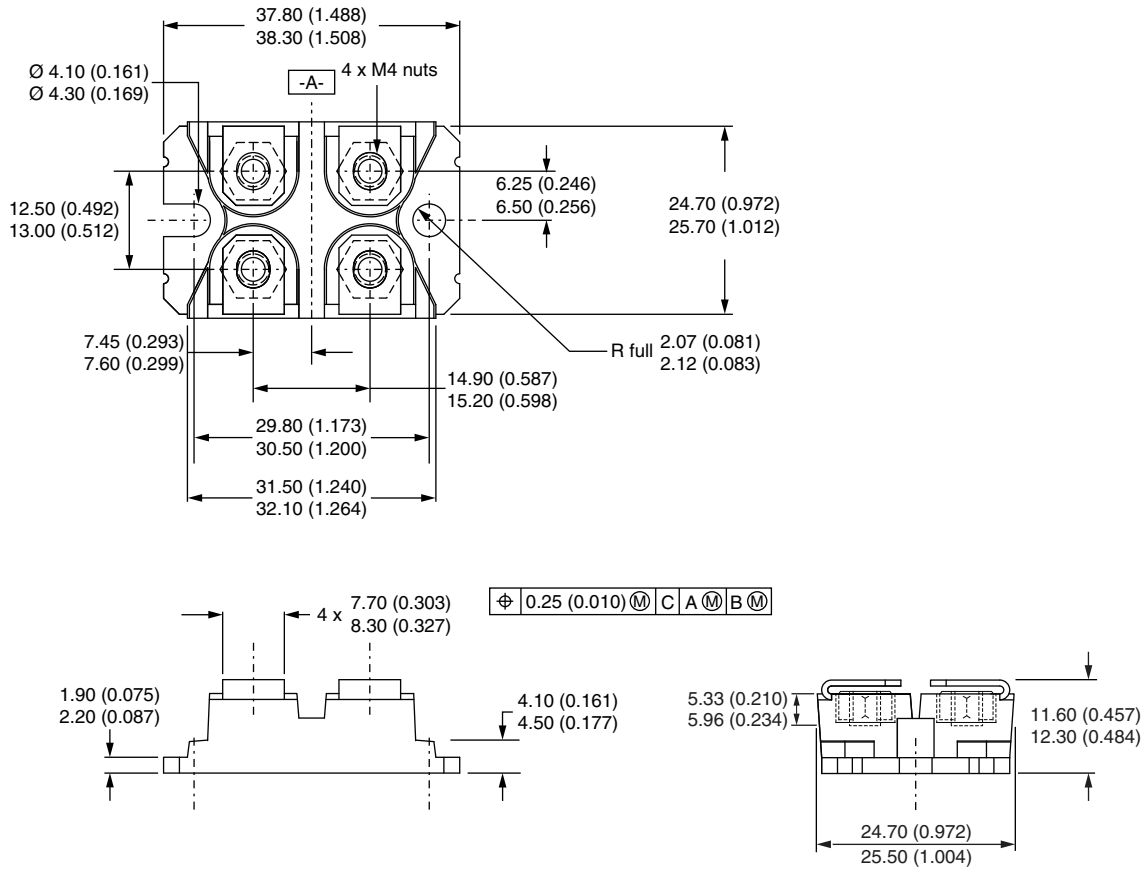

**Note**

- Controlling dimension: millimeter



## Disclaimer

ALL PRODUCT, PRODUCT SPECIFICATIONS AND DATA ARE SUBJECT TO CHANGE WITHOUT NOTICE TO IMPROVE RELIABILITY, FUNCTION OR DESIGN OR OTHERWISE.

Vishay Intertechnology, Inc., its affiliates, agents, and employees, and all persons acting on its or their behalf (collectively, "Vishay"), disclaim any and all liability for any errors, inaccuracies or incompleteness contained in any datasheet or in any other disclosure relating to any product.

Vishay makes no warranty, representation or guarantee regarding the suitability of the products for any particular purpose or the continuing production of any product. To the maximum extent permitted by applicable law, Vishay disclaims (i) any and all liability arising out of the application or use of any product, (ii) any and all liability, including without limitation special, consequential or incidental damages, and (iii) any and all implied warranties, including warranties of fitness for particular purpose, non-infringement and merchantability.

Statements regarding the suitability of products for certain types of applications are based on Vishay's knowledge of typical requirements that are often placed on Vishay products in generic applications. Such statements are not binding statements about the suitability of products for a particular application. It is the customer's responsibility to validate that a particular product with the properties described in the product specification is suitable for use in a particular application. Parameters provided in datasheets and / or specifications may vary in different applications and performance may vary over time. All operating parameters, including typical parameters, must be validated for each customer application by the customer's technical experts. Product specifications do not expand or otherwise modify Vishay's terms and conditions of purchase, including but not limited to the warranty expressed therein.



Hyperlinks included in this datasheet may direct users to third-party websites. These links are provided as a convenience and for informational purposes only. Inclusion of these hyperlinks does not constitute an endorsement or an approval by Vishay of any of the products, services or opinions of the corporation, organization or individual associated with the third-party website. Vishay disclaims any and all liability and bears no responsibility for the accuracy, legality or content of the third-party website or for that of subsequent links.

Vishay products are not designed for use in life-saving or life-sustaining applications or any application in which the failure of the Vishay product could result in personal injury or death unless specifically qualified in writing by Vishay. Customers using or selling Vishay products not expressly indicated for use in such applications do so at their own risk. Please contact authorized Vishay personnel to obtain written terms and conditions regarding products designed for such applications.

No license, express or implied, by estoppel or otherwise, to any intellectual property rights is granted by this document or by any conduct of Vishay. Product names and markings noted herein may be trademarks of their respective owners.

## Looking for pricing, stock, or lifecycle information?

Click below to explore more details on WIN SOURCE:

-  [View VS-FC270SA20 on WIN SOURCE](#)
-  [Vishay Information](#)

## Optimize Your Supply Chain with WIN SOURCE Solutions

-  Global Sourcing Solution
-  Obsolete Management
-  Cost Control Management
-  Shortage Management
-  Alternative Solution
-  Excess Inventory Management