



**THE DATASHEET OF  
JCE0624D15**



## JCE Series



- 2:1 Input Range
- DIP-24 Plastic Case
- Operating Temperature  $-40\text{ }^{\circ}\text{C}$  to  $+100\text{ }^{\circ}\text{C}$
- Single & Dual Outputs
- Optional Metal Case
- 1500 VDC Isolation, 3000 VDC Option
- 3 Year Warranty

## Specification

## Input

Input Voltage Range	<ul style="list-style-type: none"> <li>• 12 V (9-18 VDC)</li> <li>• 24 V (18-36 VDC)</li> <li>• 48 V (36-75 VDC)</li> </ul>
Input Current	<ul style="list-style-type: none"> <li>• See table</li> </ul>
Input Filter	<ul style="list-style-type: none"> <li>• Pi network</li> </ul>
Input Reflected Ripple	<ul style="list-style-type: none"> <li>• 20 mA pk-pk through 12 <math>\mu\text{H}</math> inductor and 4.7 <math>\mu\text{F}</math> capacitor</li> </ul>
Input Surge	<ul style="list-style-type: none"> <li>• 12 V models 25 VDC for 100 ms</li> <li>• 24 V models 50 VDC for 100 ms</li> <li>• 48 V models 100 VDC for 100 ms</li> </ul>
Under Voltage Lockout	<ul style="list-style-type: none"> <li>• 12 V models on <math>&gt;8.5\text{ V}</math>, off <math>&lt;8.0\text{ V}</math></li> <li>• 24 V models on <math>&gt;16.5\text{ V}</math>, off <math>&lt;15.5\text{ V}</math></li> <li>• 48 V models on <math>&gt;34.5\text{ V}</math>, off <math>&lt;33.5\text{ V}</math></li> </ul>

## Output

Output Voltage	<ul style="list-style-type: none"> <li>• See table</li> </ul>
Output Voltage Balance	<ul style="list-style-type: none"> <li>• <math>\pm 2\%</math> max, dual output models</li> </ul>
Initial Set Accuracy	<ul style="list-style-type: none"> <li>• <math>\pm 2\%</math> max</li> </ul>
Minimum Load	<ul style="list-style-type: none"> <li>• No minimum load required</li> </ul>
Line Regulation	<ul style="list-style-type: none"> <li>• <math>\pm 0.5\%</math> max</li> </ul>
Load Regulation	<ul style="list-style-type: none"> <li>• <math>\pm 1.2\%</math> max, for single output and <math>\pm 5\%</math> max for dual output from 10-100%</li> </ul>
Cross Regulation	<ul style="list-style-type: none"> <li>• <math>\pm 5\%</math> max, on dual output models (see note 1)</li> </ul>
Start Up Delay	<ul style="list-style-type: none"> <li>• 20 ms typical</li> </ul>
Ripple & Noise	<ul style="list-style-type: none"> <li>• 80 mV pk-pk (100 mV for D24 models), 20 MHz bandwidth. See note 2</li> </ul>
Transient Response	<ul style="list-style-type: none"> <li>• 3% max deviation, recovery to within 1% in 300 <math>\mu\text{s}</math> for a 25% load change (4% max. deviation for S3V3 models)</li> </ul>
Overload Protection	<ul style="list-style-type: none"> <li>• 135% - 185% of full load</li> </ul>
Short Circuit Protection	<ul style="list-style-type: none"> <li>• Trip and restart (hiccup mode), auto recovery</li> </ul>
Maximum Capacitive Load	<ul style="list-style-type: none"> <li>• See table</li> </ul>
Temperature Coefficient	<ul style="list-style-type: none"> <li>• <math>0.02\%/^{\circ}\text{C}</math> max</li> </ul>

## General

Efficiency	<ul style="list-style-type: none"> <li>• See table</li> </ul>
Isolation Voltage	<ul style="list-style-type: none"> <li>• 1500 VDC Input to Output</li> <li>• For optional high isolation versions 3000 VDC Input to Output add suffix -H to model number</li> <li>• 1000 VDC Input to Case</li> <li>• 1000 VDC Output to Case</li> </ul>
Isolation Capacitance	<ul style="list-style-type: none"> <li>• 1000 pF typical input to output</li> </ul>
Isolation Resistance	<ul style="list-style-type: none"> <li>• <math>10^9\Omega</math></li> </ul>
Switching Frequency	<ul style="list-style-type: none"> <li>• 330 kHz typical</li> </ul>
Power Density	<ul style="list-style-type: none"> <li>• <math>15\text{ W/in}^3</math></li> </ul>
MTBF	<ul style="list-style-type: none"> <li>• <math>&gt;800\text{ KHrs}</math> to MIL-STD-217F at <math>25\text{ }^{\circ}\text{C}</math>, GB</li> </ul>

## Environmental

Operating Temperature	<ul style="list-style-type: none"> <li>• <math>-40\text{ }^{\circ}\text{C}</math> to <math>+100\text{ }^{\circ}\text{C}</math> (see derating curve)</li> </ul>
Case Temperature	<ul style="list-style-type: none"> <li>• <math>+100\text{ }^{\circ}\text{C}</math> max</li> </ul>
Storage Temperature	<ul style="list-style-type: none"> <li>• <math>-55\text{ }^{\circ}\text{C}</math> to <math>+125\text{ }^{\circ}\text{C}</math></li> </ul>
Cooling	<ul style="list-style-type: none"> <li>• Convection-cooled</li> </ul>
Operating Humidity	<ul style="list-style-type: none"> <li>• Up to 95% RH, non-condensing</li> </ul>

## EMC

Emissions	<ul style="list-style-type: none"> <li>• EN55032 Class A conducted</li> </ul>
ESD Immunity	<ul style="list-style-type: none"> <li>• EN61000-4-2, level 3, Perf Criteria B</li> </ul>
Radiated Immunity	<ul style="list-style-type: none"> <li>• EN61000-4-3, 10 V/m, Perf Criteria A</li> </ul>
EFT/Burst	<ul style="list-style-type: none"> <li>• EN61000-4-4, level 3 Perf Criteria A</li> </ul>
Surge	<ul style="list-style-type: none"> <li>• EN61000-4-5, level 2, Perf Criteria A*</li> </ul>
Conducted Immunity	<ul style="list-style-type: none"> <li>• EN61000-4-6, 10 Vrms, Perf Criteria A</li> </ul>
Magnetic Field	<ul style="list-style-type: none"> <li>• EN61000-4-8, 1 A/m, Perf Criteria A</li> </ul>

## Safety

Safety Approvals	<ul style="list-style-type: none"> <li>• UL62368-1, CAN/CSA C22.2 No. 62368-1 and 62368-1, CE (Meets all applicable directives), UKCA (Meets all applicable legislation)</li> </ul>
------------------	---

\* External input capacitor required, 220 $\mu\text{F}/100\text{V}$  (See note 7)

## Models and Ratings

Input Voltage	Output Voltage	Output Current	Input Current <sup>(1)</sup>		Maximum Capacitive Load <sup>(2)</sup>	Efficiency	Model Number <sup>(4,5)</sup>
			No Load	Full Load			
9-18 VDC	3.3 V	1400 mA	7 mA	513 mA	470 $\mu$ F	75%	JCE0612S3V3
	5.0 V	1200 mA	7 mA	633 mA	470 $\mu$ F	79%	JCE0612S05
	12.0 V	500 mA	10 mA	602 mA	100 $\mu$ F	83%	JCE0612S12
	15.0 V	400 mA	10 mA	595 mA	100 $\mu$ F	84%	JCE0612S15
	24.0 V	250 mA	20 mA	610 mA	47 $\mu$ F	82%	JCE0612S24
	$\pm 3.3$ V	$\pm 909$ mA	10 mA	658 mA	$\pm 220$ $\mu$ F	76%	JCE0612D03
	$\pm 5.0$ V	$\pm 600$ mA	10 mA	625 mA	$\pm 220$ $\mu$ F	80%	JCE0612D05
	$\pm 12.0$ V	$\pm 250$ mA	15 mA	602 mA	$\pm 100$ $\mu$ F	83%	JCE0612D12
	$\pm 15.0$ V	$\pm 200$ mA	20 mA	595 mA	$\pm 100$ $\mu$ F	84%	JCE0612D15
18-36 VDC	3.3 V	1400 mA	7 mA	260 mA	470 $\mu$ F	74%	JCE0624S3V3
	5.0 V	1200 mA	7 mA	316 mA	470 $\mu$ F	79%	JCE0624S05
	12.0 V	500 mA	7 mA	301 mA	100 $\mu$ F	83%	JCE0624S12
	15.0 V	400 mA	7 mA	301 mA	100 $\mu$ F	83%	JCE0624S15
	24.0 V	250 mA	10 mA	305 mA	47 $\mu$ F	82%	JCE0624S24
	$\pm 3.3$ V	$\pm 909$ mA	7 mA	329 mA	$\pm 220$ $\mu$ F	76%	JCE0624D03
	$\pm 5.0$ V	$\pm 600$ mA	7 mA	312 mA	$\pm 220$ $\mu$ F	80%	JCE0624D05
	$\pm 12.0$ V	$\pm 250$ mA	10 mA	301 mA	$\pm 100$ $\mu$ F	83%	JCE0624D12
	$\pm 15.0$ V	$\pm 200$ mA	15 mA	298 mA	$\pm 100$ $\mu$ F	84%	JCE0624D15
36-75 VDC	3.3 V	1400 mA	7 mA	128 mA	470 $\mu$ F	76%	JCE0648S3V3
	5.0 V	1200 mA	7 mA	154 mA	470 $\mu$ F	82%	JCE0648S05
	12.0 V	500 mA	7 mA	151 mA	100 $\mu$ F	84%	JCE0648S12
	15.0 V	400 mA	7 mA	151 mA	100 $\mu$ F	84%	JCE0648S15
	24.0 V	250 mA	7 mA	151 mA	47 $\mu$ F	84%	JCE0648S24
	$\pm 3.3$ V	$\pm 909$ mA	7 mA	162 mA	$\pm 220$ $\mu$ F	78%	JCE0648D03
	$\pm 5.0$ V	$\pm 600$ mA	7 mA	154 mA	$\pm 220$ $\mu$ F	82%	JCE0648D05
	$\pm 12.0$ V	$\pm 250$ mA	7 mA	151 mA	$\pm 100$ $\mu$ F	84%	JCE0648D12
	$\pm 15.0$ V	$\pm 200$ mA	7 mA	151 mA	$\pm 100$ $\mu$ F	84%	JCE0648D15
	$\pm 24.0$ V	$\pm 125$ mA	15 mA	158 mA	$\pm 47$ $\mu$ F	80%	JCE0648D24

### Notes

- When one output is set at 100% load and the other varies between 25% & 100% load.
- Measured with 20 MHz bandwidth and 1  $\mu$ F ceramic capacitor across output rails.
- Input current specified at nominal 12 V, 24 V or 48 V input.
- For optional 3000 VDC isolation add suffix -H to part number e.g. JCE0624S12-H
- For optional metal case version add suffix -M to part number e.g. JCE0612S24-M
- Maximum capacitive load is per output
- For surge immunity, external input capacitor required, 220  $\mu$ F/100 V, 24 V & 48 V input models are Perf Criteria A, 12 V input models are Perf Criteria B.

## Mechanical Details

### Plastic Case

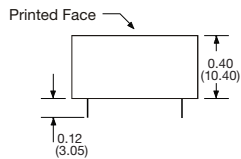
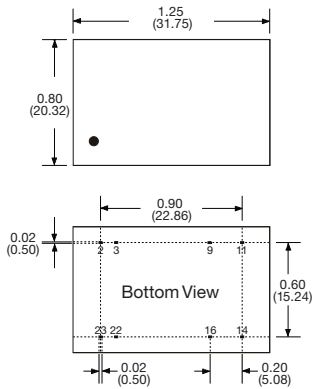

Pin	Single	Dual
2	-Vin	-Vin
3	-Vin	-Vin
9	No Pin	Common
11	N.C.	-Vout
14	+Vout	+Vout
16	-Vout	Common
22	+Vin	+Vin
23	+Vin	+Vin

### Optional Metal Case

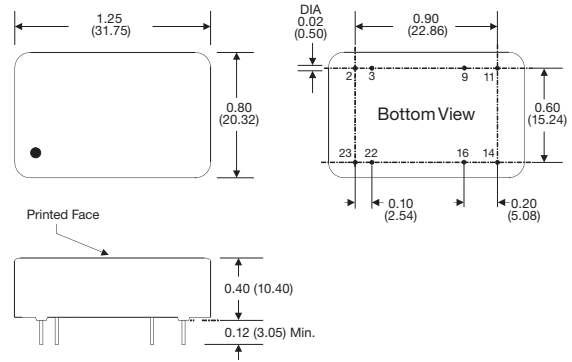

### Notes

- All dimensions are in inches (mm)
- Weight: 0.03 lbs (13 g) for plastic case, 0.04 lbs (16.5 g) for metal case
- Pin diameter: 0.02  $\pm$  0.002 (0.5  $\pm$  0.005)
- Pin pitch and length tolerance:  $\pm$ 0.014 ( $\pm$ 0.35)
- Case tolerance:  $\pm$ 0.02 ( $\pm$ 0.5)
- Package: 24 pin DIL black plastic (UL94V-0) or optional nickel-coated copper.

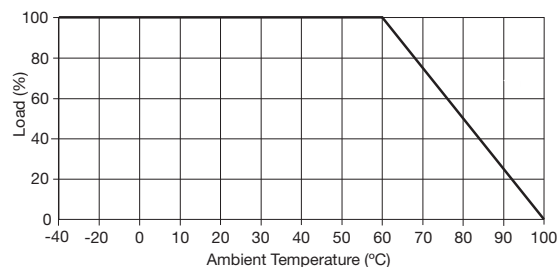

## Application Notes

### Derating Curve









## Looking for pricing, stock, or lifecycle information?

Click below to explore more details on WIN SOURCE:

-  [View JCE0624D15 on WIN SOURCE](#)
-  [XP Power Information](#)

## Optimize Your Supply Chain with WIN SOURCE Solutions

-  Global Sourcing Solution
-  Obsolete Management
-  Cost Control Management
-  Shortage Management
-  Alternative Solution
-  Excess Inventory Management