



**THE DATASHEET OF
ISE1215A-H**



1 Watt

- Single Output
- SMD Package
- Industry Standard Pinout
- Operating Temperature -40 °C to +105 °C
- 1500 VDC Isolation, 3000 VDC Option
- 3 Year Warranty



Dimensions:

ISE:
0.500 x 0.44 x 0.285" (12.7 x 11.2 x 7.25 mm)

Models & Ratings

Input Voltage	Output Voltage	Output Current	Input Current ⁽²⁾		Maximum Capacitive Load	Efficiency ⁽³⁾	Model Number ^(1,4)
			No Load	Full Load			
2.97-3.63 V	3.3 V	303 mA	25 mA	404 mA	220 µF	72%	ISE0303A
	5 V	200 mA	25 mA	404 mA	220 µF	74%	ISE0305A
	12 V	84 mA	25 mA	404 mA	220 µF	80%	ISE0312A
	15 V	67 mA	25 mA	404 mA	220 µF	80%	ISE0315A
	24 V	42 mA	25 mA	404 mA	220 µF	80%	ISE0324A
4.5-5.5 V	3.3 V	303 mA	20 mA	250 mA	220 µF	74%	ISE0503A ⁽⁵⁾
	5 V	200 mA	20 mA	250 mA	220 µF	80%	ISE0505A ⁽⁵⁾
	15 V	67 mA	20 mA	250 mA	220 µF	80%	ISE0515A ⁽⁵⁾
10.8-13.2 V	24 V	42 mA	20 mA	250 mA	220 µF	80%	ISE0524A ⁽⁵⁾
	3.3 V	303 mA	15 mA	104 mA	220 µF	74%	ISE1203A
	5 V	200 mA	15 mA	104 mA	220 µF	80%	ISE1205A
	9 V	111 mA	15 mA	104 mA	220 µF	80%	ISE1209A
13.5-16.5 V	12 V	84 mA	15 mA	104 mA	220 µF	81%	ISE1212A
	15 V	67 mA	15 mA	104 mA	220 µF	81%	ISE1215A
	5 V	200 mA	10 mA	82 mA	220 µF	80%	ISE1505A
21.6-26.4 V	15 V	67 mA	10 mA	82 mA	220 µF	81%	ISE1515A
	3.3 V	303 mA	7 mA	52 mA	220 µF	71%	ISE2403A
	5 V	200 mA	7 mA	52 mA	220 µF	80%	ISE2405A
	9 V	111 mA	7 mA	52 mA	220 µF	80%	ISE2409A
	12 V	84 mA	7 mA	52 mA	220 µF	80%	ISE2412A
	15 V	67 mA	7 mA	52 mA	220 µF	81%	ISE2415A
	24 V	42 mA	7 mA	52 mA	220 µF	81%	ISE2424A

Notes

1. For optional 3000 VDC isolation add suffix '-H' to end of part number. Not all models will support this option, please check with sales.
2. Input currents measured at nominal input voltage.
3. Typical value at full load.
4. For optional tape & reel option add suffix '-TR' to the end of the p/n. Reel quantity = 500.
5. Not recommended for new design.

Mechanical Details

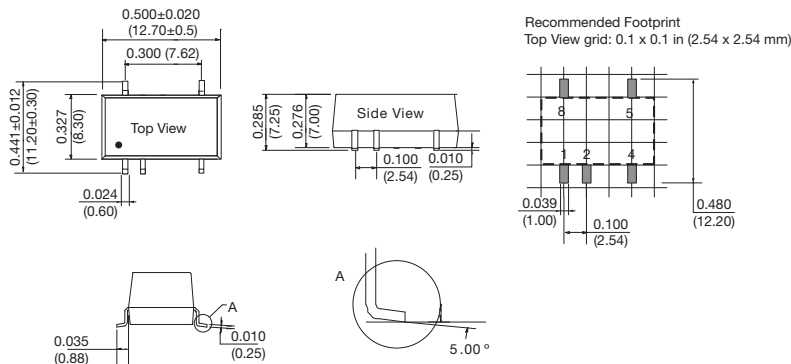

PIN CONNECTIONS	
Pin	Function
1	-Vin
2	+Vin
4	0V
5	+Vout
8	No Connection

Notes

1. All dimensions are in inches (mm)
2. Weight: 0.003 lbs (1.5 g) typical.
3. Pin diameter: 0.02 ±0.002 (0.5 ±0.005)
4. Pin pitch and length tolerance: ±0.014 (±0.35)
5. Case tolerance: ±0.02 (±0.5)

Input

Characteristic	Minimum	Typical	Maximum	Units	Notes & Conditions
Input Voltage Range	2.97		3.63	VDC	3.3 V nominal
	4.50		5.50	VDC	5 V nominal
	10.80		13.20	VDC	12 V nominal
	13.50		16.50	VDC	15 V nominal
	21.60		26.40	VDC	24 V nominal
Input Current					See Models and Ratings table
Input Reflected Ripple		15		mA pk-pk	Through 12 μ H inductor and 47 μ F capacitor
Input Surge			5	VDC for 1 s	3.3 V models
			9	VDC for 1 s	5 V models
			18	VDC for 1 s	12 V models
			21	VDC for 1 s	15 V models
			30	VDC for 1 s	24 V models
Input Filter	Capacitor				

Output

Characteristic	Minimum	Typical	Maximum	Units	Notes & Conditions
Output Voltage	3.3		24	VDC	See Models and Ratings table
Initial Set Accuracy			-7.5, +2.5	%	At 70% load
Minimum Load	10			%	
Line Regulation			± 1.2	%	Per 1% change of input voltage ($\pm 1.5\%$ for 3V3 output)
Load Regulation				%	See graph
Start Up Delay				ms	
Ripple and Noise			30/60	mV pk-pk	For models ≤ 12 V/ For 15 V & 24 V models, 20 MHz bandwidth, measured using 0.1 μ F capacitor
Transient Response			3	% deviation	Recovery to within 1% in 500 μ s for a 25% load change (5% max. deviation for 3.3 & 5 V models)
Short Circuit Protection					Continuous, with auto recovery, except 1 s max for 24 input V models
Maximum Capacitive Load			220	μ F	
Temperature Coefficient			0.02	%/ $^{\circ}$ C	

General

Characteristic	Minimum	Typical	Maximum	Units	Notes & Conditions
Efficiency					See Models and Ratings table
Isolation: Input to Output	1500			VDC	For optional high isolation versions, 3000 VDC input to output add suffix -H to model number
Switching Frequency	50		300	kHz	Full load, nominal input
Isolation Resistance	10^9			Ω	Input to output, tested at 500 VDC
Isolation Capacitance		20		pF	Input to output
Power Density			15.9	Win ³	
Mean Time Between Failure	3500			khrs	MIL-HDBK-217F, +25 $^{\circ}$ C GB
Weight		0.003 (1.5)		lb (g)	
Recommended Solder Profile	IPC/JEDEC J-STD-020D.1				

Environmental

Characteristic	Minimum	Typical	Maximum	Units	Notes & Conditions
Operating Temperature	-40		+105	$^{\circ}$ C	Derate from 100% load at +100 $^{\circ}$ C to 80% load at 105 $^{\circ}$ C
Storage Temperature	-55		+125	$^{\circ}$ C	
Case Temperature			+115	$^{\circ}$ C	
Operating Humidity			95	% RH	Non-condensing
Cooling					Natural convection

EMC: Emissions

Phenomenon	Standard	Test Level	Notes & Conditions
Conducted	EN55032	Class B	See Application Note for Class B filter
Radiated	EN55032	Class B	See Application Note for Class B filter

EMC: Immunity

Phenomenon	Standard	Test Level	Criteria	Notes & Conditions
ESD Immunity	EN61000-4-2	3	B	
Radiated Immunity	EN61000-4-3	3 V/m	A	
EFT/Burst	EN61000-4-4	2	B	External input capacitor required, 330 μ F/100 V
Surge	EN61000-4-5	2	B	External input capacitor required, 330 μ F/100 V
Conducted Immunity	EN61000-4-6	3 V rms	A	
Magnetic Fields	EN61000-4-8	1 A/m	A	

Safety Approvals

Agency	Standard
CE	Meets all applicable directives
UKCA	Meets all applicable legislation

Load Regulation

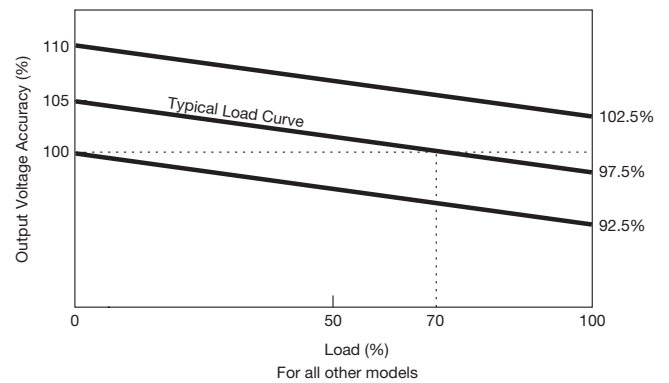
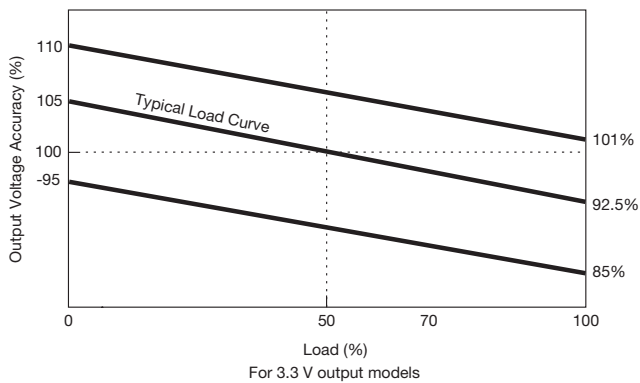

Application Note

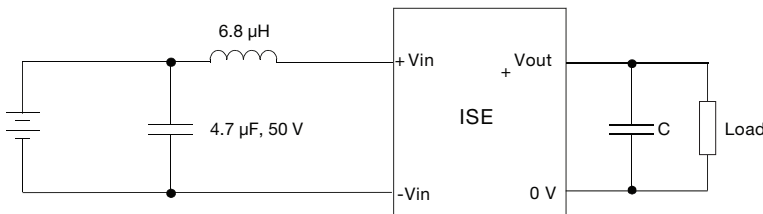

EMI Filter for Class B Emissions









Output Voltage	C
3.3	10.00 μ F
5/6	10.00 μ F
9	4.70 μ F
12	2.20 μ F
15	1.00 μ F
24	0.47 μ F

Looking for pricing, stock, or lifecycle information?

Click below to explore more details on WIN SOURCE:

-  [View ISE1215A-H on WIN SOURCE](#)
-  [XP Power Information](#)

Optimize Your Supply Chain with WIN SOURCE Solutions

-  Global Sourcing Solution
-  Obsolete Management
-  Cost Control Management
-  Shortage Management
-  Alternative Solution
-  Excess Inventory Management