



**THE DATASHEET OF
AZ6962-1CE-12DE**



AZ6962

10 AMP SUBMINIATURE POWER RELAY

FEATURES

- High sensitivity, 120mW pickup
- Dielectric strength 5000Vrms
- Isolation spacing greater than 10mm
- 10kV surge voltage
- Proof tracking index (PTI/CTI) 250
- Class F insulation system standard
- 10 Amp switching capability
- Epoxy sealed
- UL, CUR file E44211
- VDE file 40025524



CONTACTS

Arrangement	SPDT (1 Form C), SPST - N.O. (1 Form A)
Ratings	Resistive load: Max. switched power: 300W or 2500VA Max. switched current: 10A Max. switched voltage: 125 VDC* or 440 VAC * Note: If switching voltage is greater than 30 VDC, special precautions must be taken. Please contact the factory.
Rated Load UL, CUR	10 A at 250VAC resistive, 30k cycles (1 Form C) 10 A at 30VDC resistive, 30k cycles (1 Form C) B300, R300 Pilot Duty (1 Form C) 1/2HP at 240VAC, 30k cycles (N.O.) 1/3HP at 120VAC, 30k cycles (N.O.)
VDE	8A at 250VAC resistive, 100k cycles (1 Form A and 1 Form C)
Material	Silver tin oxide
Resistance	<100 milliohms initially (24V, 1A)

GENERAL DATA

Life Expectancy Mechanical Electrical	Minimum operations 1 x 10 ⁷ 1 x 10 ⁵ at 8A, 250VAC res.
Operate Time (typical)	7ms at nominal coil voltage
Release Time (typical)	3ms at nominal coil voltage (with no coil suppression)
Dielectric Strength (at sea level for 1 min.)	5000Vrms coil to contact 2500Vrms between contact sets 1000Vrms between open contacts
Insulation Resistance	1000 megohms min. at 20°C, 500VDC, 50% RH
Dropout	Greater than 10% of nominal coil voltage
Ambient Temperature Operating Storage	At nominal coil voltage -40°C (-40°F) to 85°C (185°F) -40°C (-40°F) to 155°C (221°F)
Vibration	Break Contact: 0.8mm DA 10 ...55 Hz Make Contact: 1.65mm DA 10...55 Hz
Shock	NO: 10g NC: 5g
Enclosure	P.B.T. polyester, UL94 V-O
Terminals	Tinned copper alloy, P.C.
Max. Solder Temp.	270°C (518°F)
Max. Solder Time	5 seconds
Max. Solvent Temp.	80°C (176°F)
Max. Immersion Time	30 seconds
Weight (approx.)	8 grams

COIL

Power At Pickup Voltage (typical)	120mW (up to 24VDC coil) (1 pole) 140mW (48VDC and 60VDC coil) (1 pole)
Max. Continuous Dissipation Temperature Rise	1.2W at 20°C (68°F) ambient 20°C (36°F) at nominal coil voltage
Temperature	Max. 155°C (311°F)

NOTES

1. All values at 20°C (68°F).
2. Relay may pull in with less than "Must Operate" value.
3. Specifications subject to change without notice.

AMERICAN ZETTLER, INC.

4/14/16

AZ6962

RELAY ORDERING DATA

COIL SPECIFICATIONS - 1A & 1C				ORDER NUMBER*	
Nominal Coil VDC	Must Operate VDC	Max. Continuous VDC	Coil Resistance Ohm	1 Form A (SPST-NO)	1 Form C (SPDT)
5	3.5	7.5	113 ± 10%	AZ6962-1AE-5DE	AZ6962-1CE-5DE
6	4.2	9.0	164 ± 10%	AZ6962-1AE-6DE	AZ6962-1CE-6DE
9	6.3	13.5	360 ± 10%	AZ6962-1AE-9DE	AZ6962-1CE-9DE
12	8.4	18.0	620 ± 10%	AZ6962-1AE-12DE	AZ6962-1CE-12DE
18	12.6	27.0	1,295 ± 10%	AZ6962-1AE-18DE	AZ6962-1CE-18DE
24	16.8	36.0	2,350 ± 15%	AZ6962-1AE-24DE	AZ6962-1CE-24DE
48	33.6	72.0	8,000 ± 15%	AZ6962-1AE-48DE	AZ6962-1CE-48DE
60	42.0	90.0	12,500 ± 15%	AZ6962-1AE-60DE	AZ6962-1CE-60DE

Add suffix "A" for gold plated contacts.

MECHANICAL DATA

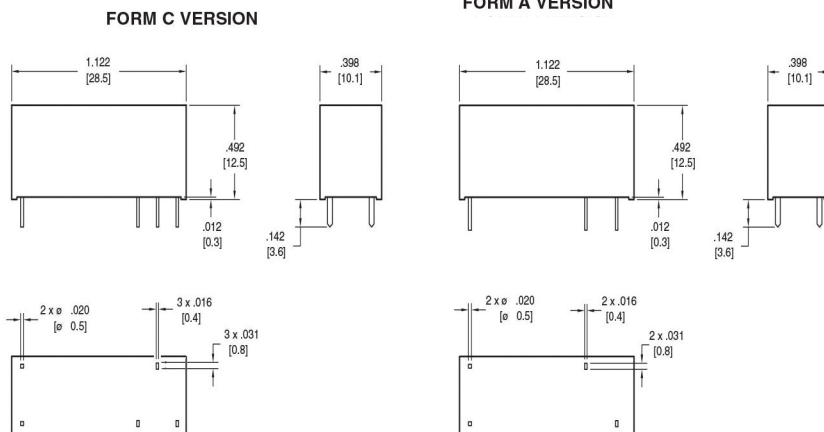

PC BOARD LAYOUT

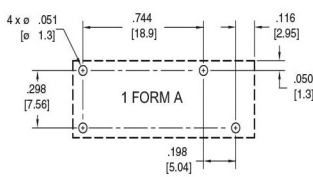

VIEWED TOWARD TERMINALS

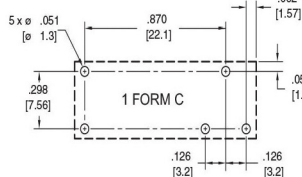

CIRCUIT DIAGRAM

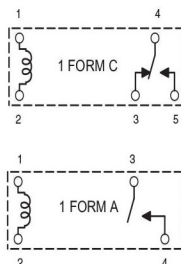

VIEWED TOWARD TERMINALS

Coil Temperature Rise

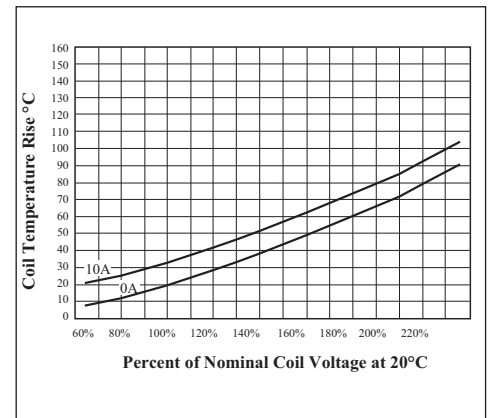

Maximum Switching Capacity (1 Form A, and 1 Form C)

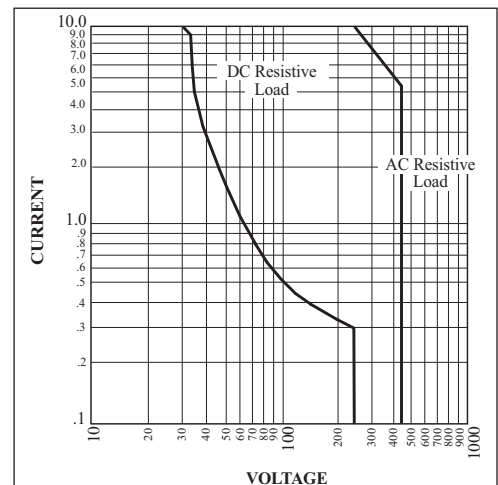

Dimensions in inches with metric equivalents in parentheses. Tolerance: ± .010"

AMERICAN ZETTLER, INC.

4/14/16

PHONE: (949) 831-5000



www.azettler.com

E-MAIL: SALES@AZETTLER.COM

This specification provides an overview of the most significant part features. Any individual applications and operating conditions are not taken into consideration. It is recommended to test the product under application conditions. Responsibility for the application remains with the customer. Proper operation and service life cannot be guaranteed if the part is operated outside the specified limits.

Looking for pricing, stock, or lifecycle information?

Click below to explore more details on WIN SOURCE:

-  [View AZ6962-1CE-12DE on WIN SOURCE](#)
-  [American Zettler, Inc. Information](#)

Optimize Your Supply Chain with WIN SOURCE Solutions

-  Global Sourcing Solution
-  Obsolete Management
-  Cost Control Management
-  Shortage Management
-  Alternative Solution
-  Excess Inventory Management