



**THE DATASHEET OF
OP482ACBZ-RL**



FEATURES

- High slew rate: 9 V/ μ s
- Wide bandwidth: 4 MHz
- Low supply current: 250 μ A/amplifier maximum
- Low offset voltage: 3 mV maximum
- Low bias current: 100 pA maximum
- Fast settling time
- Common-mode range includes V+
- Unity-gain stable
- 14-ball wafer level chip scale for quad

APPLICATIONS

- Active filters
- Fast amplifiers
- Integrators
- Supply current monitoring

GENERAL DESCRIPTION

The OP282/OP482 dual and quad operational amplifiers feature excellent speed at exceptionally low supply currents. The slew rate is typically 9 V/ μ s with a supply current of less than 250 μ A per amplifier. These unity-gain stable amplifiers have a typical gain bandwidth of 4 MHz.

The JFET input stage of the OP282/OP482 ensures that the bias current is typically a few picoamps and is less than 500 pA over the full temperature range. The offset voltage is less than 3 mV for the dual amplifier and less than 4 mV for the quad amplifier.

With a wide output swing (within 1.5 V of each supply), low power consumption, and high slew rate, the OP282/OP482 are ideal for battery-powered systems or power-restricted applications. An input common-mode range that includes the positive supply makes the OP282/OP482 an excellent choice for high-side signal conditioning.

The OP282/OP482 are specified over the extended industrial temperature range. The OP282 is available in the standard 8-lead, narrow SOIC and MSOP packages. The OP482 is available in the PDIP and narrow SOIC packages, as well as a 14-ball WLCSP.

PIN CONNECTIONS

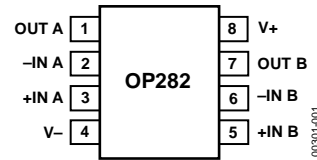

Figure 1. 8-Lead, Narrow-Body SOIC (S-Suffix) [R-8]



Figure 2. 8-Lead MSOP [RM-8]

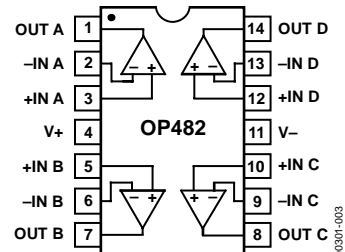

Figure 3. 14-Lead PDIP (P-Suffix) [N-14]

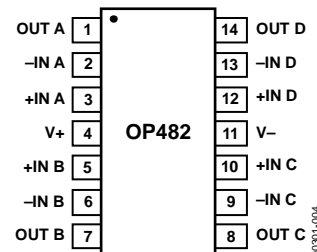

Figure 4. 14-Lead, Narrow-Body SOIC (S-Suffix) [R-14]

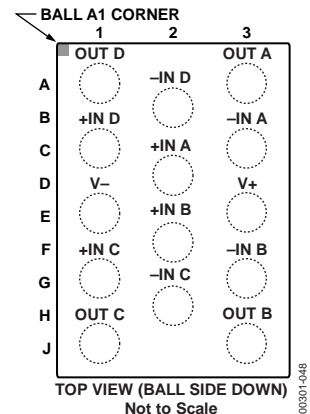

Figure 5. 14-Ball WLCSP [CB-14-2]

Rev. I

[Document Feedback](#)

Information furnished by Analog Devices is believed to be accurate and reliable. However, no responsibility is assumed by Analog Devices for its use, nor for any infringements of patents or other rights of third parties that may result from its use. Specifications subject to change without notice. No license is granted by implication or otherwise under any patent or patent rights of Analog Devices. Trademarks and registered trademarks are the property of their respective owners.

TABLE OF CONTENTS

Features	1
Applications	1
General Description	1
Pin Connections	1
Revision History	2
Specifications	3
Electrical Characteristics	3
Absolute Maximum Ratings	4
Thermal Resistance	4

REVISION HISTORY

9/13—Rev. H to Rev. I

Changes to Figure 5	1
Updated Outline Dimensions	14
Changes to Ordering Guide	16

9/10—Rev. G to Rev. H

Added WLCSP	Universal
Changes to Features Section	1
Changes to General Description Section	1
Added Figure 5; Renumbered Sequentially	1
Changes to Large-Signal Voltage Gain Parameter, Table 1	3
Changes to Table 2, Thermal Resistance Section, and Table 3 ...	4
Change to Figure 30	9
Added Figure 53	16
Changes to Ordering Guide	16

7/08—Rev. F to Rev. G

Changes to Phase Inversion Section	12
Deleted Figure 45	12
Added Figure 45 and Figure 46	12
Updated Outline Dimensions	14
Changes to Ordering Guide	16

10/04—Rev. E to Rev. F

Deleted 8-Lead PDIP	Universal
Added 8-Lead MSOP	Universal
Changes to Format and Layout	Universal
Changes to Features	1
Changes to Pin Configurations	1
Changes to General Description	1
Changes to Specifications	3
Changes to Absolute Maximum Ratings	4
Changes to Table 3	4

ESD Caution	4
Typical Performance Characteristics	5
Applications Information	12
High-Side Signal Conditioning	12
Phase Inversion	12
Active Filters	12
Programmable State Variable Filter	13
Outline Dimensions	14
Ordering Guide	16

Added Figure 5 through Figure 20; Renumbered

Successive Figures	5
Updated Figure 21 and Figure 22	7
Updated Figure 23 and Figure 27	8
Updated Figure 29	9
Updated Figure 35 and Figure 36	10
Updated Figure 43	11
Changes to Applications Information	12
Changes to Figure 44	12
Deleted OP282/OP482 Spice Macro Model Section	9
Deleted Figure 4	9
Deleted OP282 Spice Marco Model	10
Updated Outline Dimensions	14
Changes to Ordering Guide	14

10/02—Rev. D to Rev. E

Edits to 8-Lead Epoxy DIP (P-Suffix) Pin	1
Edits to Ordering Guide	3
Edits to Outline Dimensions	11

9/02—Rev. C to Rev. D

Edits to 14-Lead SOIC (S-Suffix) Pin	1
Replaced 8-Lead SOIC (S-Suffix)	11

4/02—Rev. B to Rev. C

Wafer Test Limits Deleted	2
Edits to Absolute Maximum Ratings	3
Dice Characteristics Deleted	3
Edits to Ordering Guide	3
Edits to Figure 1	7
Edits to Figure 3	8
20-Position Chip Carrier (RC Suffix) Deleted	11

SPECIFICATIONS

ELECTRICAL CHARACTERISTICS

At $V_S = \pm 15.0\text{ V}$, $T_A = 25^\circ\text{C}$, unless otherwise noted; applies to both A and G grades.

Table 1.

Parameter	Symbol	Test Conditions/Comments	Min	Typ	Max	Unit
INPUT CHARACTERISTICS						
Offset Voltage	V_{OS}	OP282		0.2	3	mV
		OP282, $-40^\circ\text{C} \leq T_A \leq +85^\circ\text{C}$			4.5	mV
Input Bias Current	I_B	OP482		0.2	4	mV
		OP482, $-40^\circ\text{C} \leq T_A \leq +85^\circ\text{C}$			6	mV
Input Offset Current	I_{OS}	$V_{CM} = 0\text{ V}$		3	100	pA
		$V_{CM} = 0\text{ V}^1$			500	pA
Input Voltage Range	CMRR	$V_{CM} = 0\text{ V}$		1	50	pA
		$V_{CM} = 0\text{ V}^1$			250	pA
Common-Mode Rejection Ratio		$-11\text{ V} \leq V_{CM} \leq +15\text{ V}$, $-40^\circ\text{C} \leq T_A \leq +85^\circ\text{C}$	-11		+15	V
Large-Signal Voltage Gain	A_{VO}	$R_L = 10\text{ k}\Omega$, $V_O = \pm 13.5\text{ V}$	70	90		dB
		$R_L = 10\text{ k}\Omega$, $-40^\circ\text{C} \leq T_A \leq +85^\circ\text{C}$	20			V/mV
Offset Voltage Drift	$\Delta V_{OS}/\Delta T$			10		$\mu\text{V}/^\circ\text{C}$
Bias Current Drift	$\Delta I_B/\Delta T$			8		$\text{pA}/^\circ\text{C}$
OUTPUT CHARACTERISTICS						
Output Voltage High	V_{OH}	$R_L = 10\text{ k}\Omega$	13.5	13.9		V
Output Voltage Low	V_{OL}	$R_L = 10\text{ k}\Omega$		-13.9	-13.5	V
Short-Circuit Limit	I_{SC}	Source	3	10		mA
		Sink		-12	-8	mA
Open-Loop Output Impedance	Z_{OUT}	$f = 1\text{ MHz}$		200		Ω
POWER SUPPLY						
Power Supply Rejection Ratio	PSRR	$V_S = \pm 4.5\text{ V}$ to $\pm 18\text{ V}$, $-40^\circ\text{C} \leq T_A \leq +85^\circ\text{C}$		25	316	$\mu\text{V}/\text{V}$
Supply Current/Amplifier	I_{SY}	$V_O = 0\text{ V}$, $-40^\circ\text{C} \leq T_A \leq 85^\circ\text{C}$		210	250	μA
Supply Voltage Range	V_S		± 4.5		± 18	V
DYNAMIC PERFORMANCE						
Slew Rate	SR	$R_L = 10\text{ k}\Omega$	7	9		$\text{V}/\mu\text{s}$
Full-Power Bandwidth	BW_P	1% distortion		125		kHz
Settling Time	t_S	To 0.01%		1.6		μs
Gain Bandwidth Product	GBP			4		MHz
Phase Margin	ϕ_M			55		Degrees
NOISE PERFORMANCE						
Voltage Noise	e_n p-p	0.1 Hz to 10 Hz		1.3		μV p-p
Voltage Noise Density	e_n	$f = 1\text{ kHz}$		36		$\text{nV}/\sqrt{\text{Hz}}$
Current Noise Density	i_n			0.01		$\text{pA}/\sqrt{\text{Hz}}$

¹ The input bias and offset currents are characterized at $T_A = T_J = 85^\circ\text{C}$. Bias and offset currents are guaranteed but not tested at -40°C .

ABSOLUTE MAXIMUM RATINGS

Table 2.

Parameter	Rating
Supply Voltage	±18 V
Input Voltage	±18 V
Differential Input Voltage ¹	36 V
Output Short-Circuit Duration	Indefinite
Storage Temperature Range	−65°C to +150°C
Operating Temperature Range	−40°C to +85°C
Junction Temperature Range	−65°C to +150°C
Lead Temperature (Soldering 60 sec)	300°C

¹ For supply voltages less than ±18 V, the absolute maximum input voltage is equal to the supply voltage.

Stresses above those listed under Absolute Maximum Ratings may cause permanent damage to the device. This is a stress rating only; functional operation of the device at these or any other conditions above those indicated in the operational section of this specification is not implied. Exposure to absolute maximum rating conditions for extended periods may affect device reliability.

THERMAL RESISTANCE

θ_{JA} is specified for the worst-case conditions, that is, a device in socket for PDIP. θ_{JA} is specified for a device soldered in the circuit board for SOIC_N, MSOP, and WLCSP packages. This was measured using a standard 4-layer board.

Table 3.

Package Type	θ_{JA}	θ_{JC}	Unit
8-Lead MSOP [RM]	142	45	°C/W
8-Lead SOIC_N (S-Suffix) [R]	120	45	°C/W
14-Lead PDIP (P-Suffix) [N]	83	39	°C/W
14-Lead SOIC_N (S-Suffix) [R]	112	35	°C/W
14-Ball WLCSP [CB] ^{1,2}	70	16	°C/W

¹ Simulated thermal numbers per JE5D51-9.

² Junction-to-board thermal resistance.

ESD CAUTION



ESD (electrostatic discharge) sensitive device. Charged devices and circuit boards can discharge without detection. Although this product features patented or proprietary protection circuitry, damage may occur on devices subjected to high energy ESD. Therefore, proper ESD precautions should be taken to avoid performance degradation or loss of functionality.

TYPICAL PERFORMANCE CHARACTERISTICS

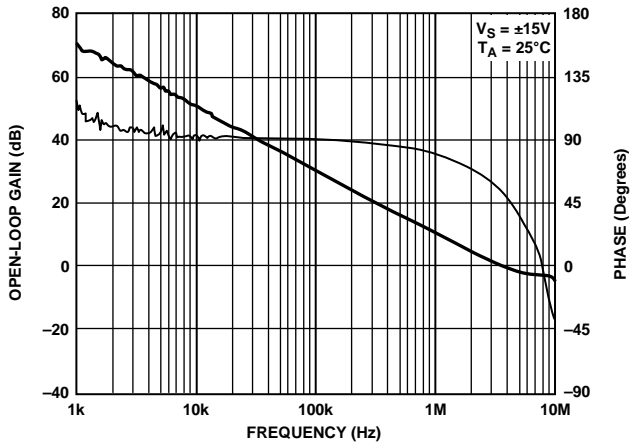

Figure 6. OP282 Open-Loop Gain and Phase vs. Frequency

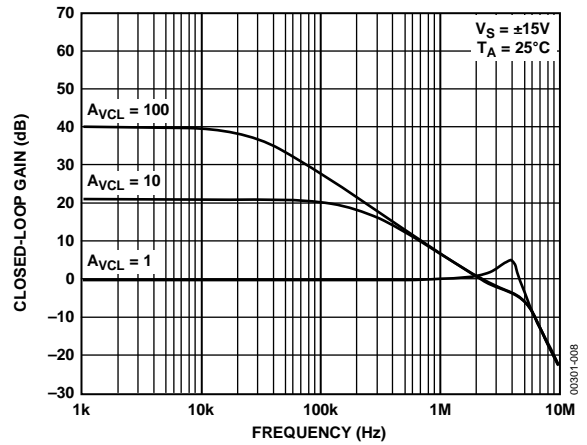

Figure 9. OP282 Closed-Loop Gain vs. Frequency

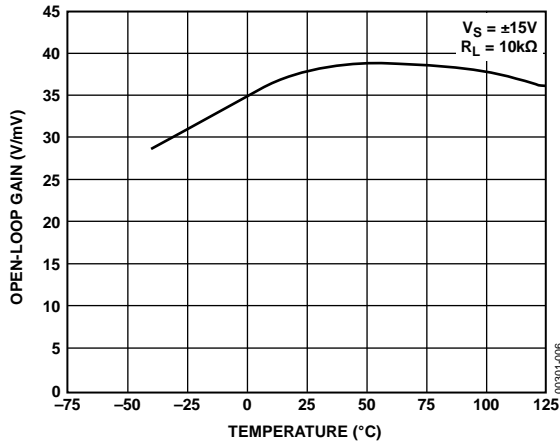

Figure 7. OP282 Open-Loop Gain vs. Temperature

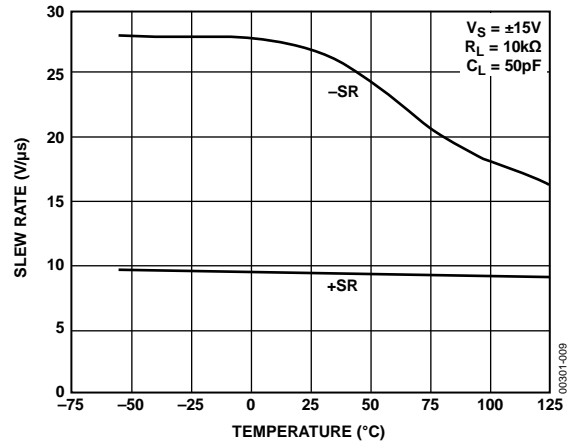

Figure 10. OP282 Slew Rate vs. Temperature

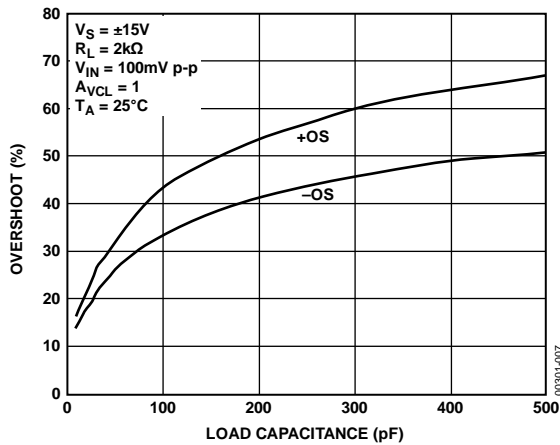

Figure 8. OP282 Small-Signal Overshoot vs. Load Capacitance

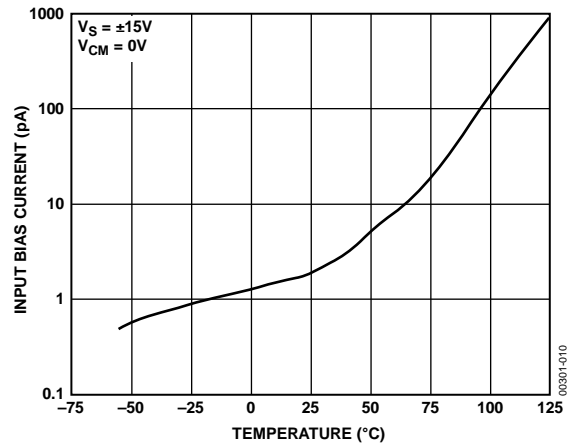

Figure 11. OP282 Input Bias Current vs. Temperature

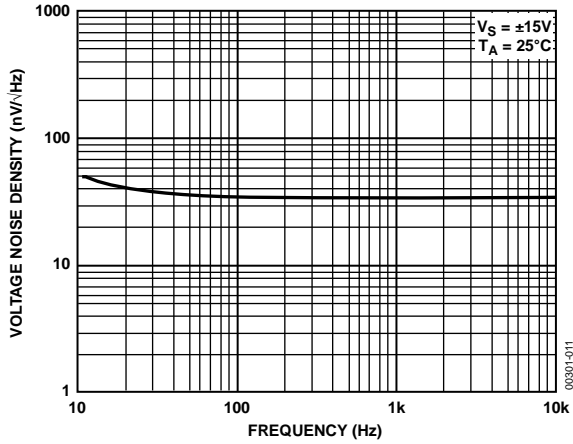

Figure 12. OP282 Voltage Noise Density vs. Frequency

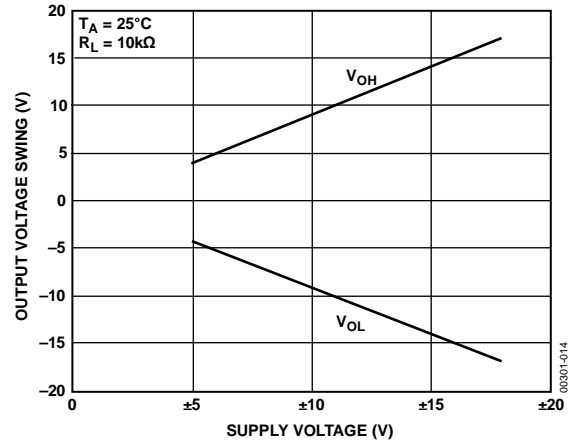

Figure 15. OP282 Output Voltage Swing vs. Supply Voltage

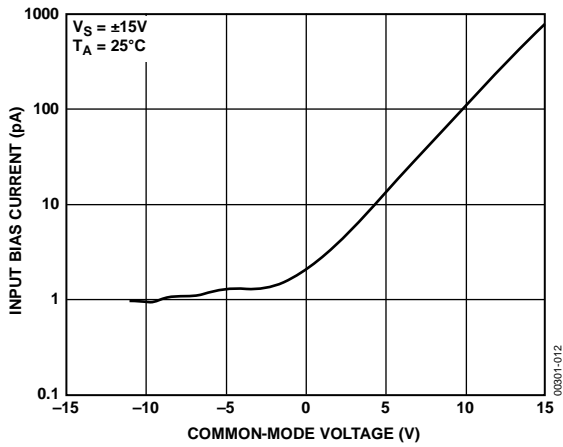

Figure 13. OP282 Input Bias Current vs. Common-Mode Voltage

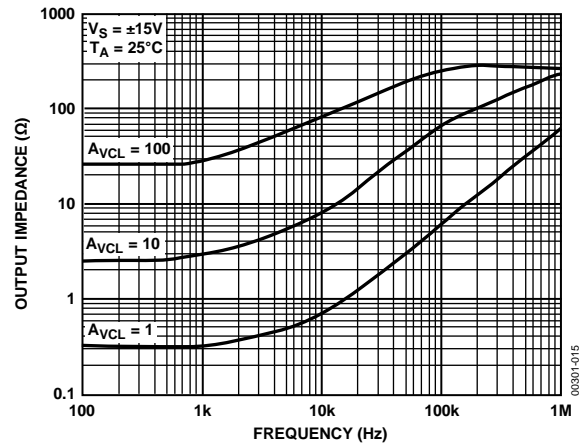

Figure 16. OP282 Closed-Loop Output Impedance vs. Frequency

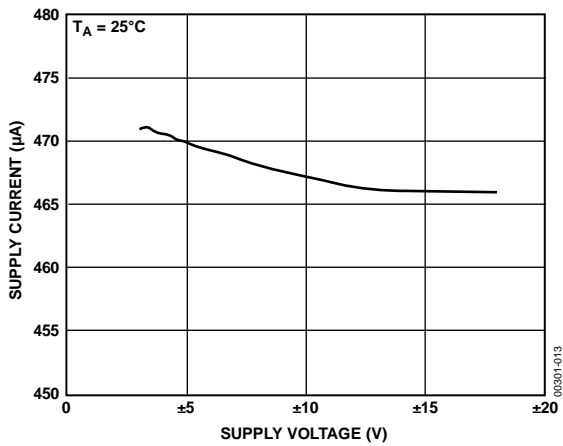

Figure 14. OP282 Supply Current vs. Supply Voltage

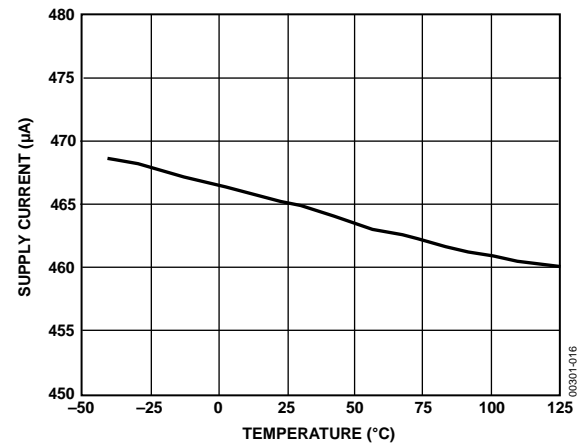

Figure 17. OP282 Supply Current vs. Temperature

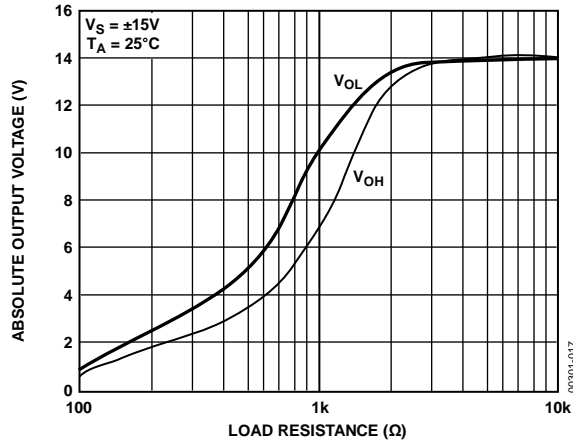

Figure 18. OP282 Absolute Output Voltage vs. Load Resistance

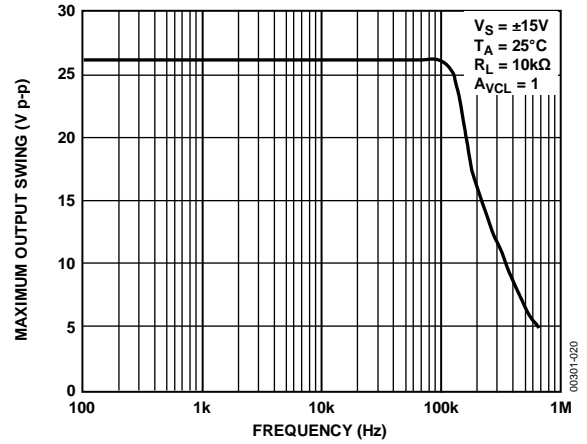

Figure 21. OP282 Maximum Output Swing vs. Frequency

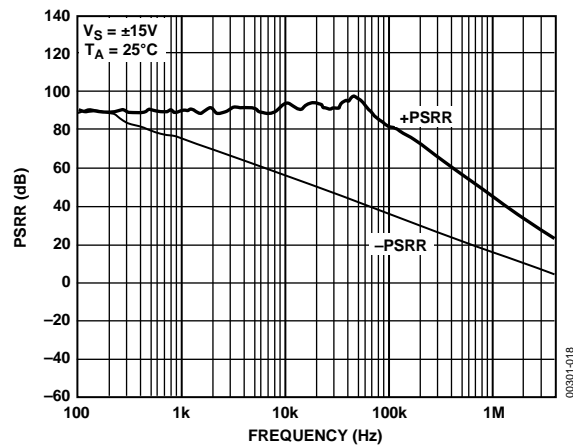

Figure 19. OP282 PSRR vs. Frequency

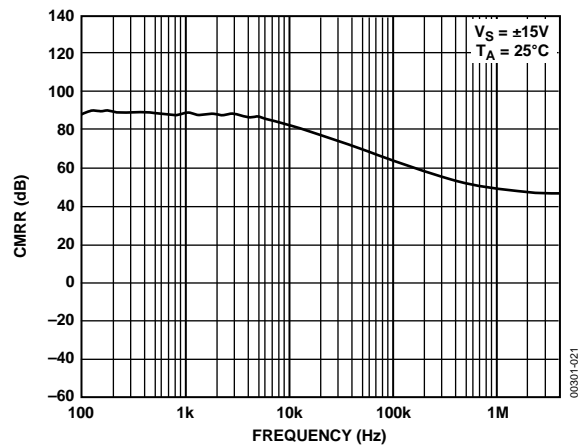

Figure 22. OP282 CMRR vs. Frequency

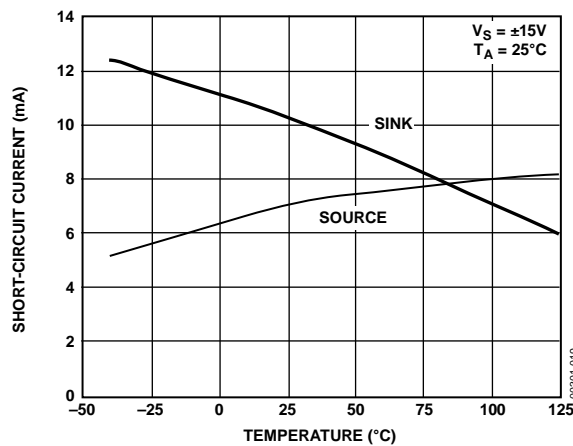

Figure 20. OP282 Short-Circuit Current vs. Temperature

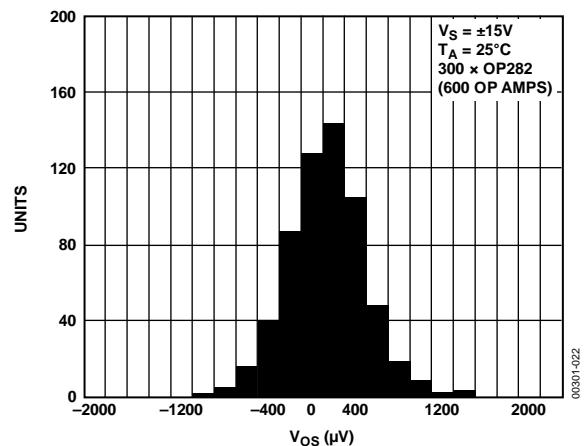

Figure 23. OP282 VOS Distribution, SOIC_N Package

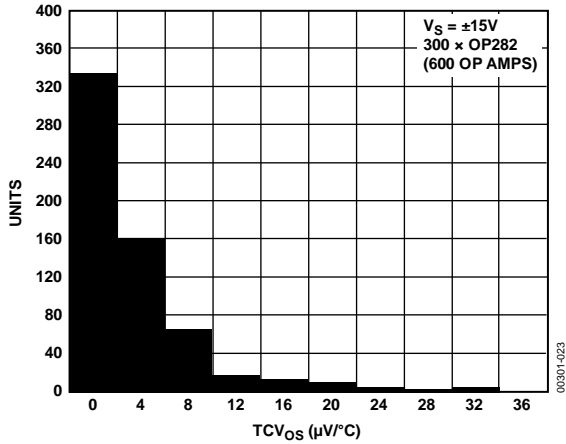

Figure 24. OP282 TCvos Distribution, SOIC_N Package

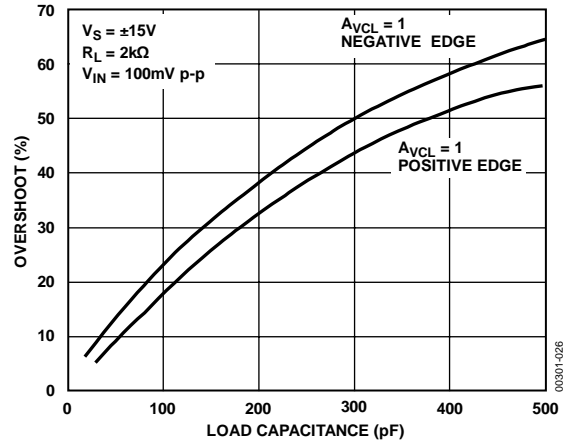

Figure 27. OP482 Small-Signal Overshoot vs. Load Capacitance

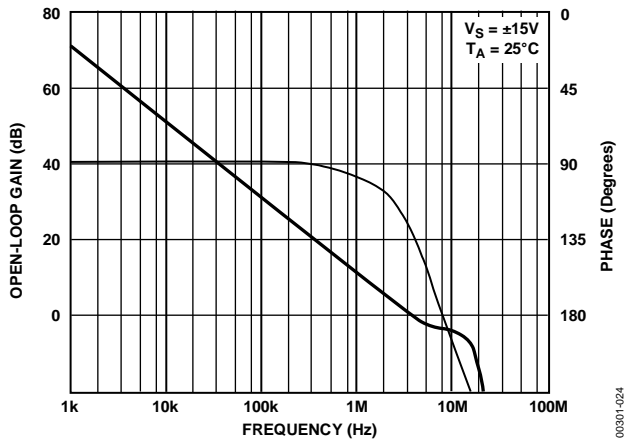

Figure 25. OP482 Open-Loop Gain and Phase vs. Frequency

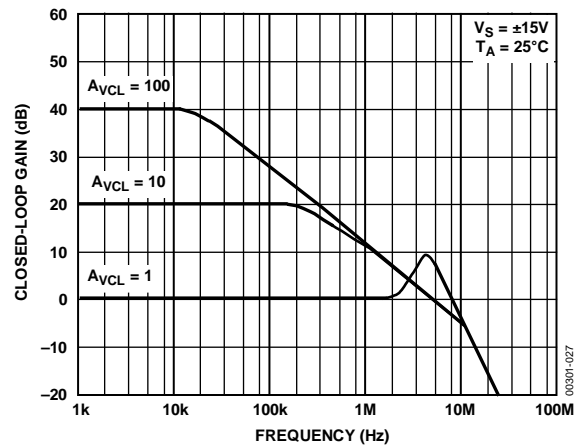

Figure 28. OP482 Closed-Loop Gain vs. Frequency

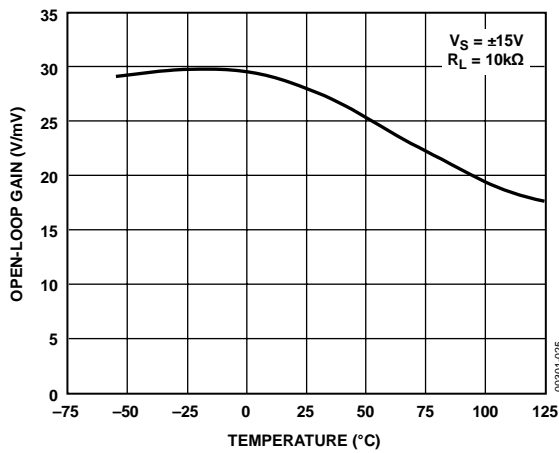

Figure 26. OP482 Open-Loop Gain vs. Temperature

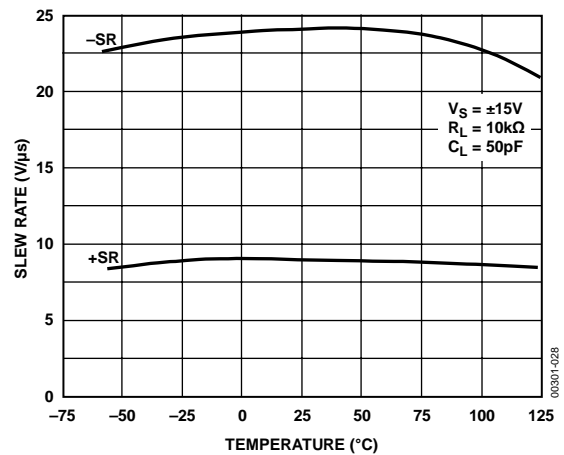

Figure 29. OP482 Slew Rate vs. Temperature

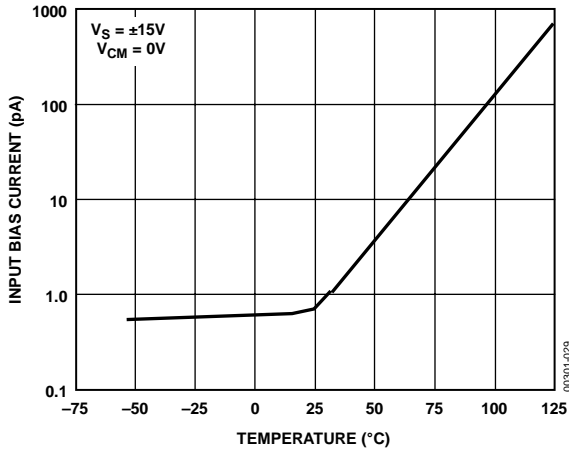

Figure 30. OP482 Input Bias Current vs. Temperature

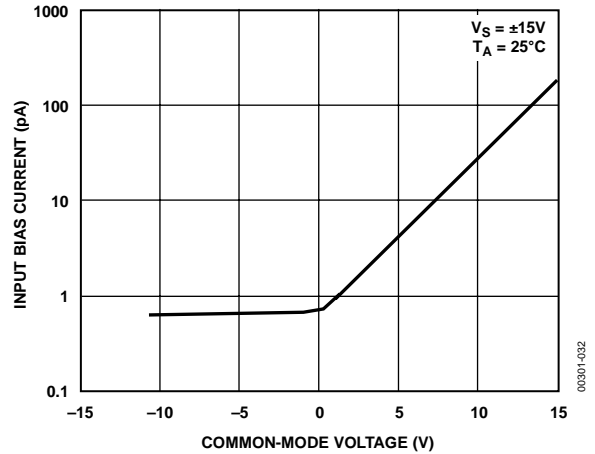

Figure 33. OP482 Input Bias Current vs. Common-Mode Voltage

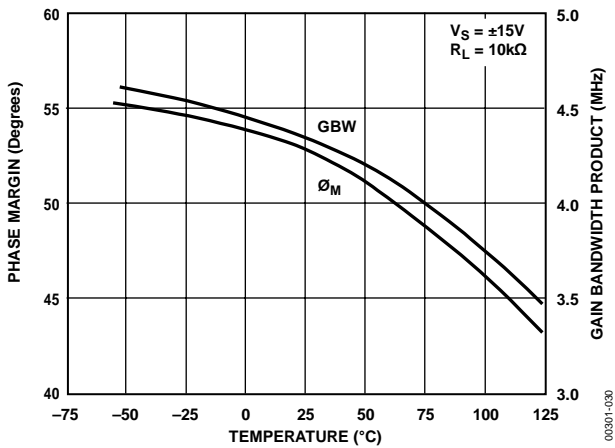

Figure 31. OP482 Phase Margin and Gain Bandwidth Product vs. Temperature

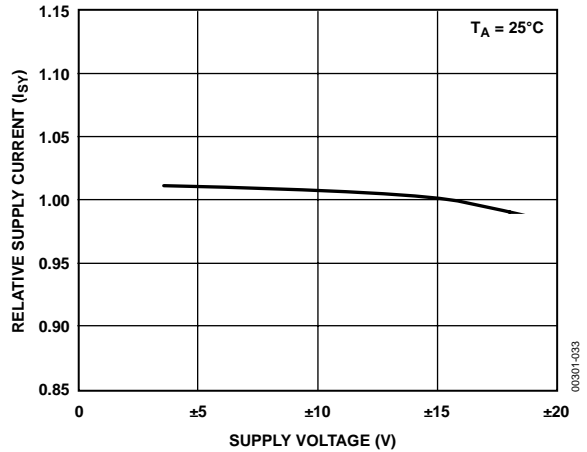

Figure 34. OP482 Relative Supply Current vs. Supply Voltage

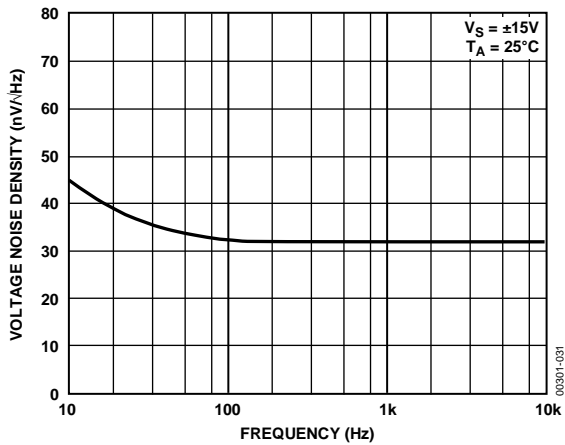

Figure 32. OP482 Voltage Noise Density vs. Frequency

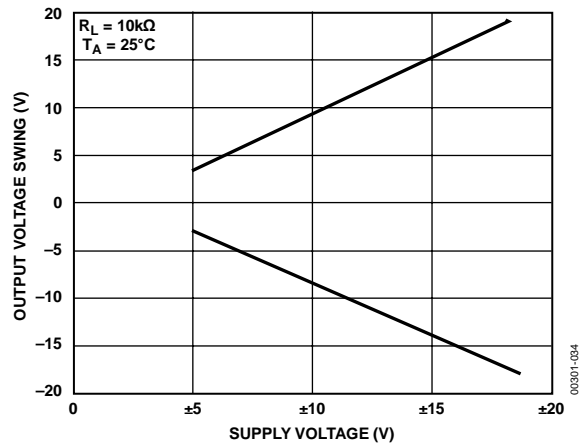

Figure 35. OP482 Output Voltage Swing vs. Supply Voltage

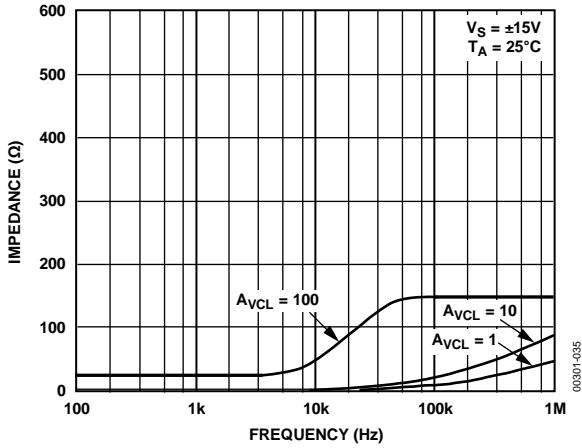

Figure 36. OP482 Closed-Loop Output Impedance vs. Frequency

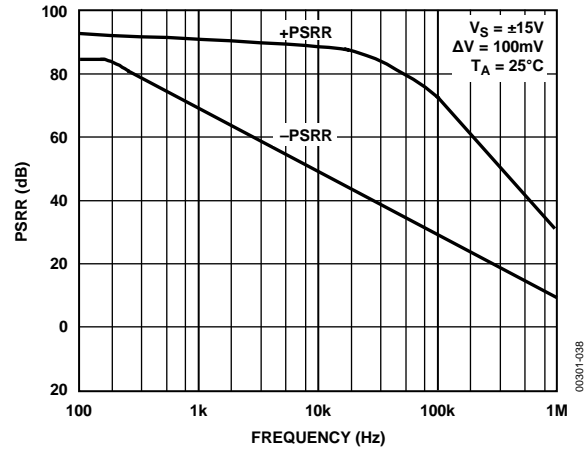

Figure 39. OP482 Power Supply Rejection Ratio (PSRR) vs. Frequency

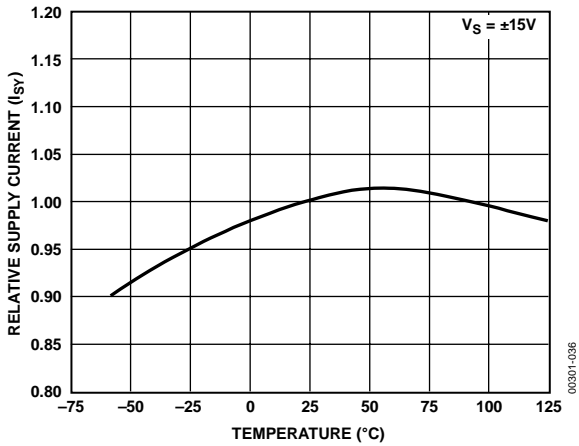

Figure 37. OP482 Relative Supply Current vs. Temperature

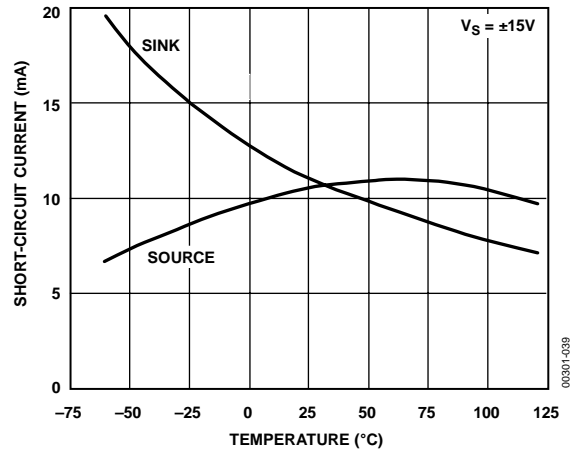

Figure 40. OP482 Short-Circuit Current vs. Temperature

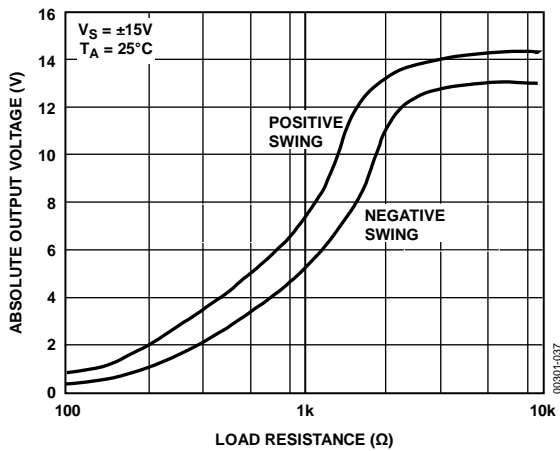

Figure 38. OP482 Maximum Output Voltage vs. Load Resistance

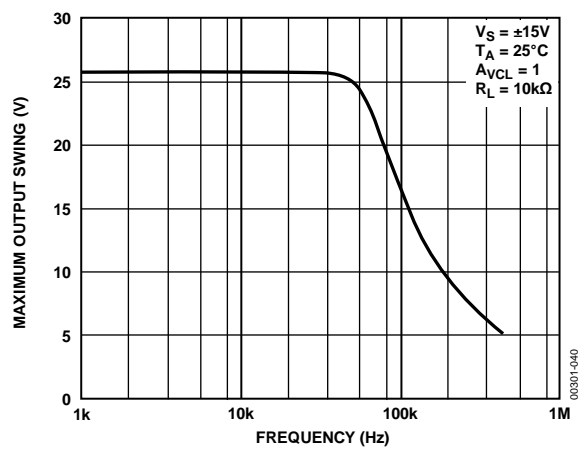

Figure 41. OP482 Maximum Output Swing vs. Frequency

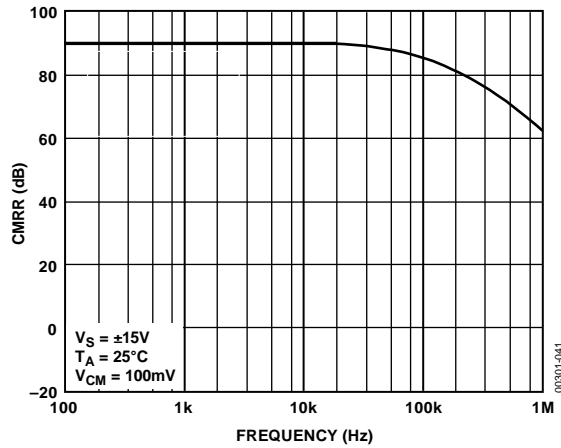

Figure 42. OP482 Common-Mode Rejection Ratio (CMRR) vs. Frequency

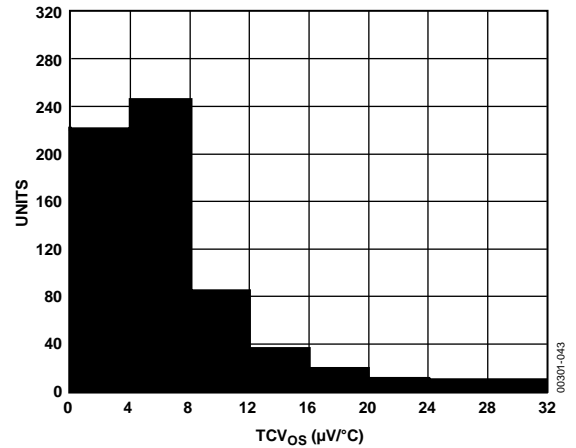

Figure 44. OP482 TCV_{OS} Distribution, PDIP Package

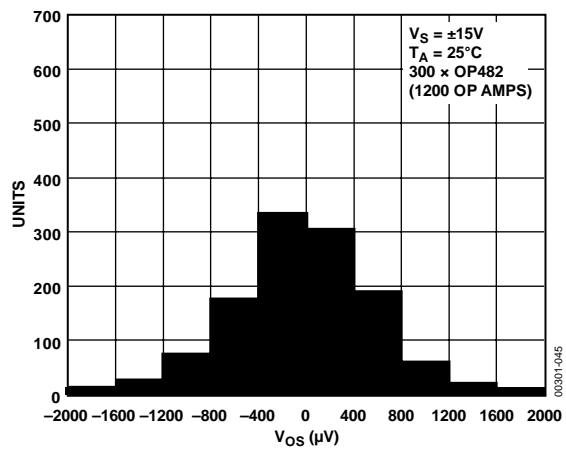

Figure 43. OP482 V_{OS} Distribution, PDIP Package

APPLICATIONS INFORMATION

The **OP282** and **OP482** are dual and quad JFET op amps that are optimized for high speed at low power. This combination makes these amplifiers excellent choices for battery-powered or low power applications that require above average performance. Applications benefiting from this performance combination include telecommunications, geophysical exploration, portable medical equipment, and navigational instrumentation.

HIGH-SIDE SIGNAL CONDITIONING

Many applications require the sensing of signals near the positive rail. **OP282** and **OP482** were tested and are guaranteed over a common-mode range ($-11\text{ V} \leq V_{CM} \leq +15\text{ V}$) that includes the positive supply.

One application where such sensing is commonly used is in the sensing of power supply currents. Therefore, the **OP282/OP482** can be used in current sensing applications, such as the partial circuit shown in Figure 45. In this circuit, the voltage drop across a low value resistor, such as the $0.1\ \Omega$ shown here, is amplified and compared to 7.5 V . The output can then be used for current limiting.

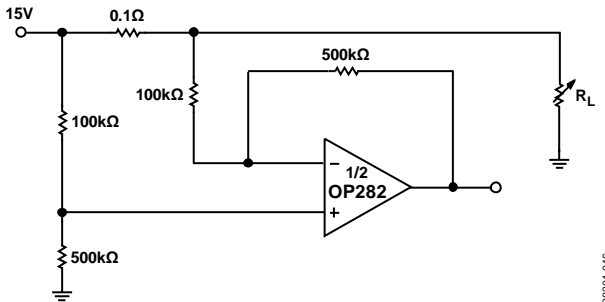

Figure 45. High-Side Signal Conditioning

PHASE INVERSION

Most JFET input amplifiers invert the phase of the input signal if either input exceeds the input common-mode range. For the **OP282/OP482**, a negative signal in excess of 11 V causes phase inversion. This is caused by saturation of the input stage, leading to the forward-biasing of a gate-drain diode. Phase reversal in the **OP282/OP482** can be prevented by using Schottky diodes to clamp the input terminals to each other and to the supplies. In the simple buffer circuit shown in Figure 46, D1 protects the op

amp against phase reversal. R1, D2, and D3 limit the input current when the input exceeds the supply rail. The resistor should be selected to limit the amount of input current below the absolute maximum rating.

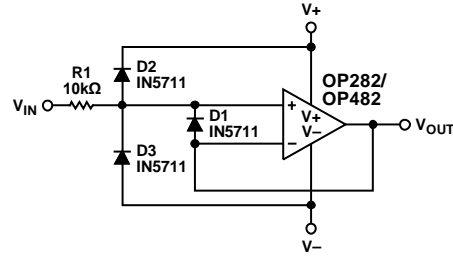

Figure 46. Phase Reversal Solution Circuit

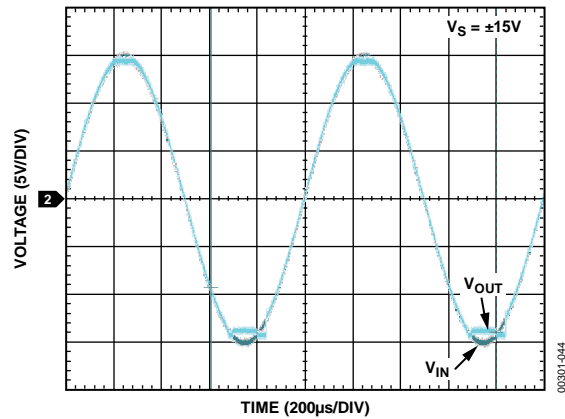

Figure 47. No Phase Reversal

ACTIVE FILTERS

The wide bandwidth and high slew rates of the **OP282/OP482** make either one an excellent choice for many filter applications.

There are many active filter configurations, but the four most popular configurations are Butterworth, elliptic, Bessel, and Chebyshev. Each type has a response that is optimized for a given characteristic, as shown in Table 4.

Table 4. Active Filter Configurations

Type	Selectivity	Overshoot	Phase	Amplitude (Pass Band)	Amplitude (Stop Band)
Butterworth	Moderate	Good	Nonlinear	Maximum flat	Equal ripple
Chebyshev	Good	Moderate		Equal ripple	
Elliptic	Best	Poor		Equal ripple	
Bessel (Thompson)	Poor	Best	Linear		

PROGRAMMABLE STATE VARIABLE FILTER

The circuit shown in Figure 48 can be used to accurately program the Q, the cutoff frequency (f_c), and the gain of a two-pole state variable filter. OP482 devices have been used in this design because of their high bandwidths, low power, and low noise. This circuit takes only three packages to build because of the quad configuration of the op amps and DACs.

The DACs shown are used in the voltage mode; therefore, many values are dependent on the accuracy of the DAC only and not on the absolute values of the DAC's resistive ladders. This makes this circuit unusually accurate for a programmable filter.

Adjusting DAC 1 changes the signal amplitude across R1; therefore, the DAC attenuation times R1 determines the amount of signal current that charges the integrating capacitor, C1.

This cutoff frequency can now be expressed as

$$f_c = \frac{1}{2\pi R1 C1} \left(\frac{D1}{256} \right)$$

where $D1$ is the digital code for the DAC.

The gain of this circuit is set by adjusting D3. The gain equation is

$$Gain = \frac{R4}{R5} \left(\frac{D3}{256} \right)$$

DAC 2 is used to set the Q of the circuit. Adjusting this DAC controls the amount of feedback from the band-pass node to the input summing node. Note that the digital value of the DAC is in the numerator; therefore, zero code is not a valid operating point.

$$Q = \frac{R2}{R3} \left(\frac{256}{D2} \right)$$

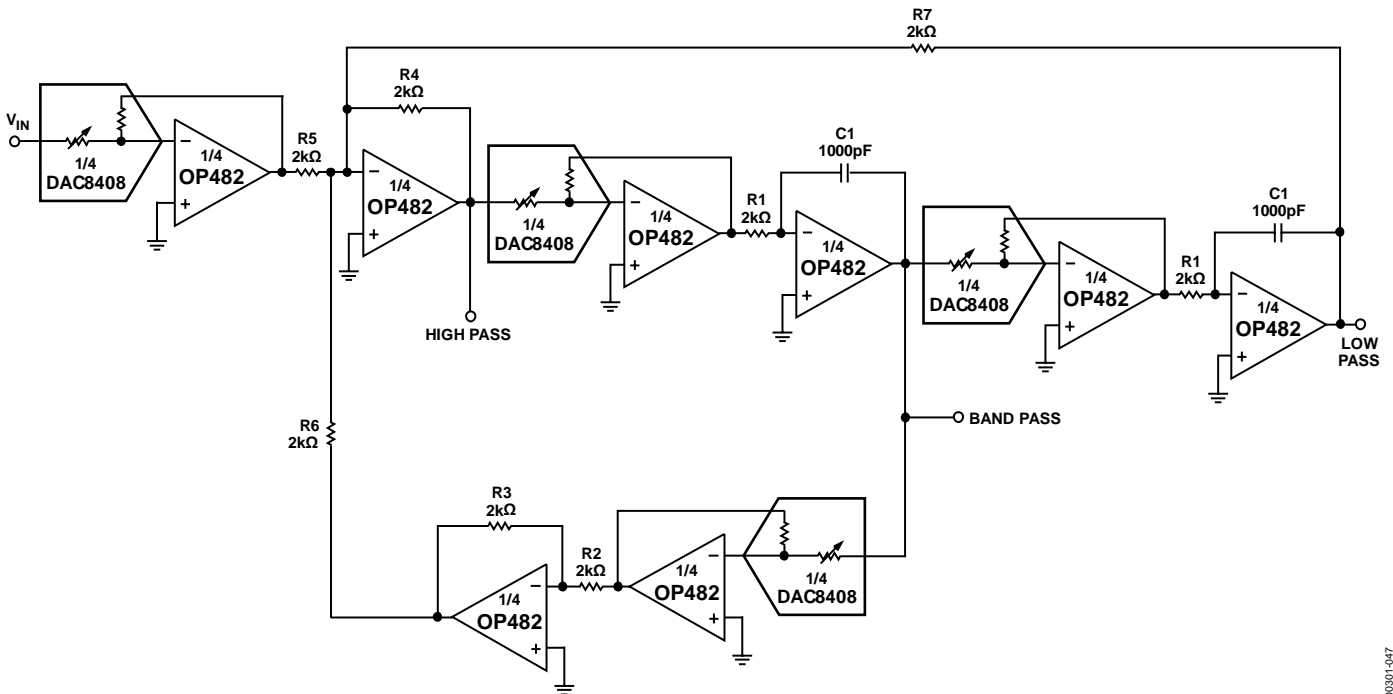
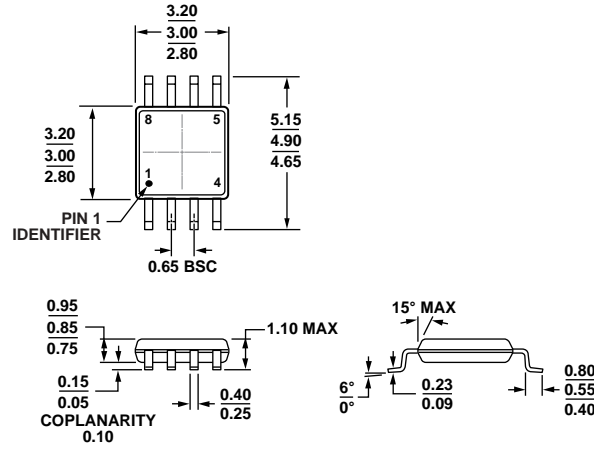

Figure 48. Programmable State Variable Filter

00301-1-47

OUTLINE DIMENSIONS



COMPLIANT TO JEDEC STANDARDS MO-187-AA

Figure 49. 8-Lead Mini Small Outline Package [MSOP] (RM-8)

Dimensions shown in millimeters

10-07-2009-B

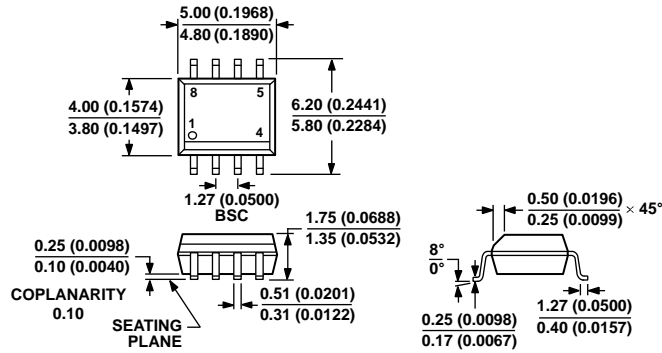

COMPLIANT TO JEDEC STANDARDS MS-012-AA

CONTROLLING DIMENSIONS ARE IN MILLIMETERS; INCH DIMENSIONS (IN PARENTHESES) ARE ROUNDED-OFF MILLIMETER EQUIVALENTS FOR REFERENCE ONLY AND ARE NOT APPROPRIATE FOR USE IN DESIGN.

Figure 50. 8-Lead Standard Small Outline Package [SOIC_N] Narrow Body S-Suffix (R-8)

Dimensions shown in millimeters and (inches)

012407-A

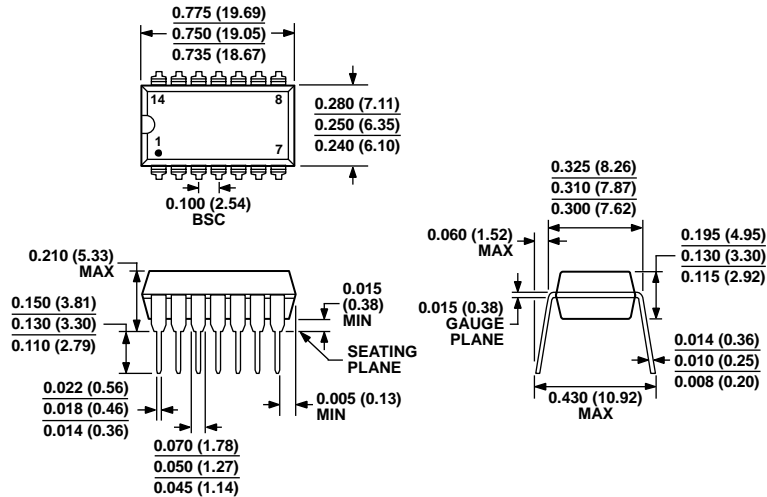

COMPLIANT TO JEDEC STANDARDS MS-001
 CONTROLLING DIMENSIONS ARE IN INCHES; MILLIMETER DIMENSIONS (IN PARENTHESES) ARE ROUNDED-OFF INCH EQUIVALENTS FOR REFERENCE ONLY AND ARE NOT APPROPRIATE FOR USE IN DESIGN. CORNER LEADS MAY BE CONFIGURED AS WHOLE OR HALF LEADS.

Figure 51. 14-Lead Plastic Dual In-Line Package [PDIP]
 P-Suffix (N-14)

Dimension shown in inches and (millimeters)

071606-A

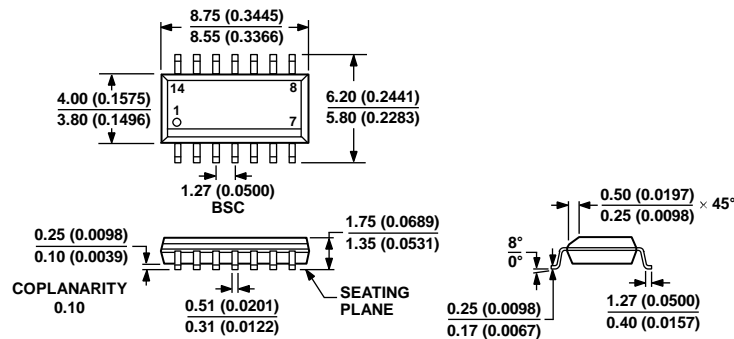

COMPLIANT TO JEDEC STANDARDS MS-012-AB
 CONTROLLING DIMENSIONS ARE IN MILLIMETERS; INCH DIMENSIONS (IN PARENTHESES) ARE ROUNDED-OFF MILLIMETER EQUIVALENTS FOR REFERENCE ONLY AND ARE NOT APPROPRIATE FOR USE IN DESIGN.

Figure 52. 14-Lead Standard Small Outline Package [SOIC_N]
 Narrow Body
 S-Suffix (R-14)

Dimensions shown in millimeters and (inches)

060106-A

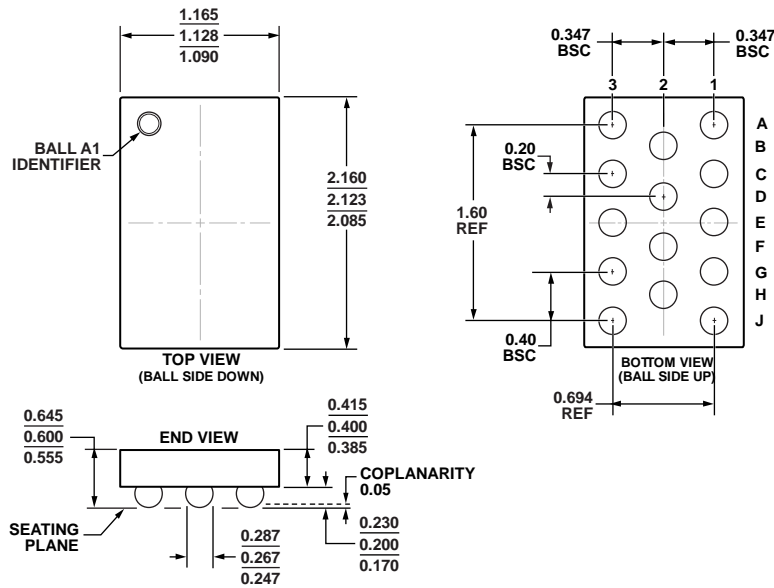

09-11-2012-B

Figure 53. 14-Ball Wafer Level Chip Scale Package [WLCSP]
CB-14-2
Controlling dimensions are millimeters

ORDERING GUIDE

Model ¹	Temperature Range	Package Description	Package Option	Branding
OP282ARMZ	-40°C to +85°C	8-Lead MSOP	RM-8	A0B
OP282ARMZ-REEL	-40°C to +85°C	8-Lead MSOP	RM-8	A0B
OP282GS	-40°C to +85°C	8-Lead SOIC_N	S-Suffix (R-8)	
OP282GS-REEL	-40°C to +85°C	8-Lead SOIC_N	S-Suffix (R-8)	
OP282GS-REEL7	-40°C to +85°C	8-Lead SOIC_N	S-Suffix (R-8)	
OP282GSZ	-40°C to +85°C	8-Lead SOIC_N	S-Suffix (R-8)	
OP282GSZ-REEL	-40°C to +85°C	8-Lead SOIC_N	S-Suffix (R-8)	
OP282GSZ-REEL7	-40°C to +85°C	8-Lead SOIC_N	S-Suffix (R-8)	
OP482ACBZ-RL	-40°C to +85°C	14-Ball WLCSP	CB-14-2	A2J
OP482ACBZ-R7	-40°C to +85°C	14-Ball WLCSP	CB-14-2	A2J
OP482GPZ	-40°C to +85°C	14-Lead PDIP	P-Suffix (N-14)	
OP482GS	-40°C to +85°C	14-Lead SOIC_N	S-Suffix (R-14)	
OP482GS-REEL	-40°C to +85°C	14-Lead SOIC_N	S-Suffix (R-14)	
OP482GS-REEL7	-40°C to +85°C	14-Lead SOIC_N	S-Suffix (R-14)	
OP482GSZ	-40°C to +85°C	14-Lead SOIC_N	S-Suffix (R-14)	
OP482GSZ-REEL	-40°C to +85°C	14-Lead SOIC_N	S-Suffix (R-14)	
OP482GSZ-REEL7	-40°C to +85°C	14-Lead SOIC_N	S-Suffix (R-14)	

¹ Z = RoHS Compliant Part.

Looking for pricing, stock, or lifecycle information?

Click below to explore more details on WIN SOURCE:

 [View OP482ACBZ-RL on WIN SOURCE](#)

 [Analog Devices Inc. Information](#)

Optimize Your Supply Chain with WIN SOURCE Solutions

-  Global Sourcing Solution
-  Obsolete Management
-  Cost Control Management
-  Shortage Management
-  Alternative Solution
-  Excess Inventory Management