



# THE DATASHEET OF IXTR40P50P



# PolarP™ Power MOSFET

## IXTR40P50P

$V_{DSS} = -500V$   
 $I_{D25} = -22A$   
 $R_{DS(on)} \leq 260m\Omega$

P-Channel Enhancement Mode  
Avalanche Rated

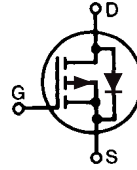

ISOPLUS247  
E153432

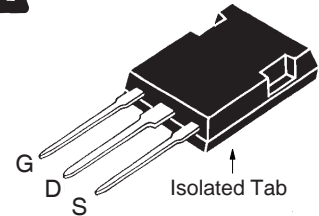

G = Gate    D = Drain  
S = Source

Symbol	Test Conditions	Maximum Ratings	
$V_{DSS}$	$T_J = 25^\circ C$ to $150^\circ C$	- 500	V
$V_{DGR}$	$T_J = 25^\circ C$ to $150^\circ C$ , $R_{GS} = 1M\Omega$	- 500	V
$V_{GSS}$	Continuous	$\pm 20$	V
$V_{GSM}$	Transient	$\pm 30$	V
$I_{D25}$	$T_C = 25^\circ C$	- 22	A
$I_{DM}$	$T_C = 25^\circ C$ , Pulse Width Limited by $T_{JM}$	-120	A
$I_A$	$T_C = 25^\circ C$	- 40	A
$E_{AS}$	$T_C = 25^\circ C$	3.5	J
dv/dt	$I_S \leq I_{DM}$ , $V_{DD} \leq V_{DSS}$ , $T_J \leq 150^\circ C$	10	V/ns
$P_D$	$T_C = 25^\circ C$	312	W
$T_J$		-55 ... +150	$^\circ C$
$T_{JM}$		150	$^\circ C$
$T_{stg}$		-55 ... +150	$^\circ C$
$T_L$	Maximum Lead Temperature for Soldering	300	$^\circ C$
$T_{SOLD}$	1.6 mm (0.062in.) from Case for 10s	260	$^\circ C$
$V_{ISOL}$	50/60 Hz, RMS, t= 1min	2500	V~
$M_d$	Mounting Force	20..120/4.5..27	N/lb
<b>Weight</b>		5	g

### Features

- Silicon Chip on Direct-Copper Bond (DCB) Substrate
  - UL Recognized Package
  - Isolated Mounting Surface
  - 2500V~ Electrical Isolation
- Dynamic dv/dt Rating
- Avalanche Rated
- Fast Intrinsic Diode
- The Rugged PolarP™ Process
- Low  $Q_G$
- Low Drain-to-Tab Capacitance
- Low Package Inductance

### Advantages

- Easy to Mount
- Space Savings
- High Power Density

### Applications

- High-Side Switches
- Push Pull Amplifiers
- DC Choppers
- Automatic Test Equipment
- Current Regulators

Symbol	Test Conditions ( $T_J = 25^\circ C$ , Unless Otherwise Specified)	Characteristic Values		
		Min.	Typ.	Max.
$BV_{DSS}$	$V_{GS} = 0V$ , $I_D = -250\mu A$	- 500		V
$V_{GS(th)}$	$V_{DS} = V_{GS}$ , $I_D = -1mA$	- 2.0		V
$I_{GSS}$	$V_{GS} = \pm 20V$ , $V_{DS} = 0V$			$\pm 100$ nA
$I_{DSS}$	$V_{DS} = V_{DSS}$ , $V_{GS} = 0V$ $T_J = 125^\circ C$			- 50 $\mu A$ - 250 $\mu A$
$R_{DS(on)}$	$V_{GS} = -10V$ , $I_D = -20A$ , Note 1			260 m $\Omega$

Symbol	Test Conditions ( $T_J = 25^\circ\text{C}$ , Unless Otherwise Specified)	Characteristic Values		
		Min.	Typ.	Max.
$g_{fs}$	$V_{DS} = -10\text{V}$ , $I_D = -20\text{A}$ , Note 1	23	38	S
$C_{iss}$	$V_{GS} = 0\text{V}$ , $V_{DS} = -25\text{V}$ , $f = 1\text{MHz}$		11.5	nF
$C_{oss}$			1150	pF
$C_{rss}$			93	pF
$t_{d(on)}$	<b>Resistive Switching Times</b> $V_{GS} = -10\text{V}$ , $V_{DS} = 0.5 \cdot V_{DSS}$ , $I_D = -20\text{A}$ $R_G = 1\Omega$ (External)		37	ns
$t_r$			59	ns
$t_{d(off)}$			90	ns
$t_f$			34	ns
$Q_{g(on)}$	$V_{GS} = -10\text{V}$ , $V_{DS} = 0.5 \cdot V_{DSS}$ , $I_D = -20\text{A}$		205	nC
$Q_{gs}$			55	nC
$Q_{gd}$			75	nC
$R_{thJC}$			0.40	$^\circ\text{C/W}$
$R_{thCS}$		0.15		$^\circ\text{C/W}$

### Source-Drain Diode

Symbol	Test Conditions ( $T_J = 25^\circ\text{C}$ , Unless Otherwise Specified)	Characteristic Values		
		Min.	Typ.	Max.
$I_S$	$V_{GS} = 0\text{V}$			- 40 A
$I_{SM}$	Repetitive, Pulse Width Limited by $T_{JM}$			-160 A
$V_{SD}$	$I_F = -20\text{A}$ , $V_{GS} = 0\text{V}$ , Note 1			- 3.0 V
$t_{rr}$	$I_F = -20\text{A}$ , $-di/dt = -150\text{A}/\mu\text{s}$ $V_R = -100\text{V}$ , $V_{GS} = 0\text{V}$		477	ns
$Q_{RM}$			14.5	$\mu\text{C}$
$I_{RM}$			- 61	A

Note 1: Pulse test,  $t \leq 300\mu\text{s}$ , duty cycle,  $d \leq 2\%$ .

### ISOPLUS247 (IXTR) Outline

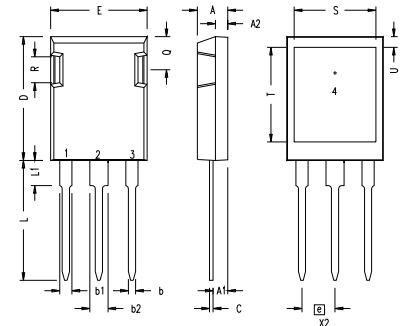

1 - Gate  
2,4 - Drain  
3 - Source

SYM	INCHES		MILLIMETERS	
	MIN	MAX	MIN	MAX
A	.190	.205	4.83	5.21
A1	.090	.100	2.29	2.54
A2	.075	.085	1.91	2.16
b	.045	.055	1.14	1.40
b1	.075	.084	1.91	2.13
b2	.115	.123	2.92	3.12
C	.024	.031	0.61	0.80
D	.819	.840	20.80	21.34
E	.620	.635	15.75	16.13
e	.215 BSC		5.45 BSC	
L	.780	.800	19.81	20.32
L1	.150	.170	3.81	4.32
Q	.220	.244	5.59	6.20
R	.170	.190	4.32	4.83
S	.520	.540	13.21	13.72
T	.620	.640	15.75	16.26
U	.065	.080	1.65	2.03

IXYS Reserves the Right to Change Limits, Test Conditions, and Dimensions.

IXYS MOSFETs and IGBTs are covered by one or more of the following U.S. patents:

4,835,592	4,931,844	5,049,961	5,237,481	6,162,665	6,404,065 B1	6,683,344	6,727,585	7,005,734 B2	7,157,338B2
4,860,072	5,017,508	5,063,307	5,381,025	6,259,123 B1	6,534,343	6,710,405 B2	6,759,692	7,063,975 B2	
4,881,106	5,034,796	5,187,117	5,486,715	6,306,728 B1	6,583,505	6,710,463	6,771,478 B2	7,071,537	

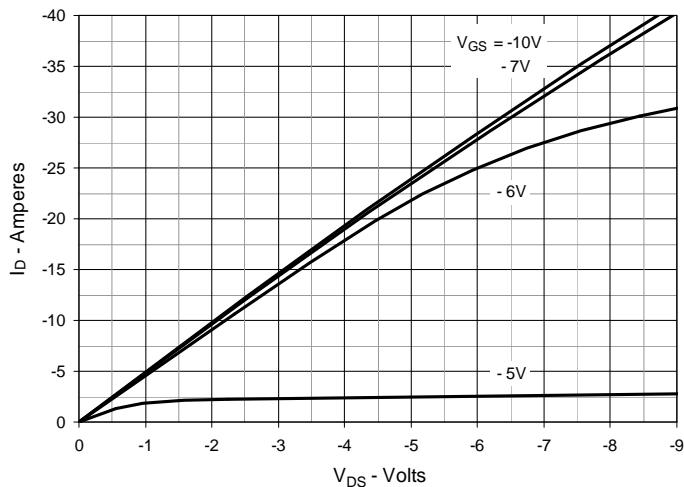
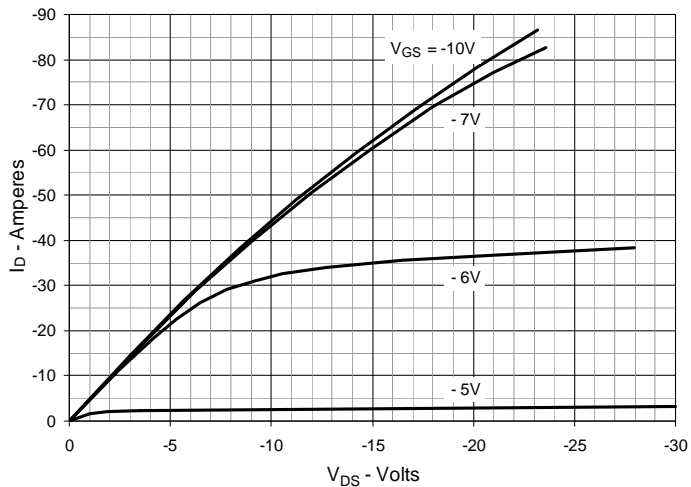
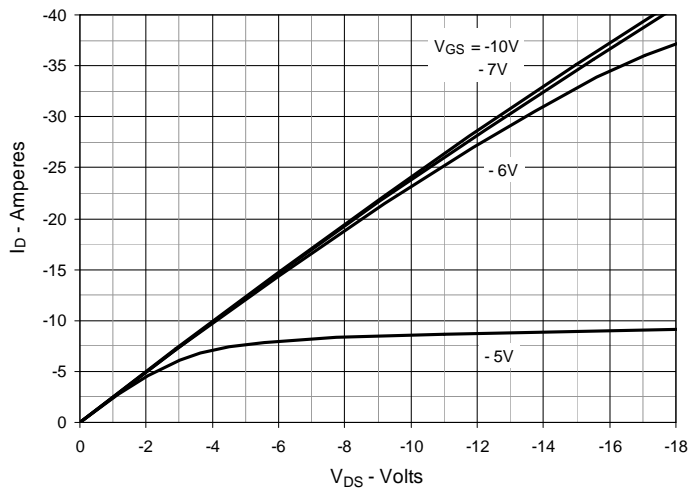
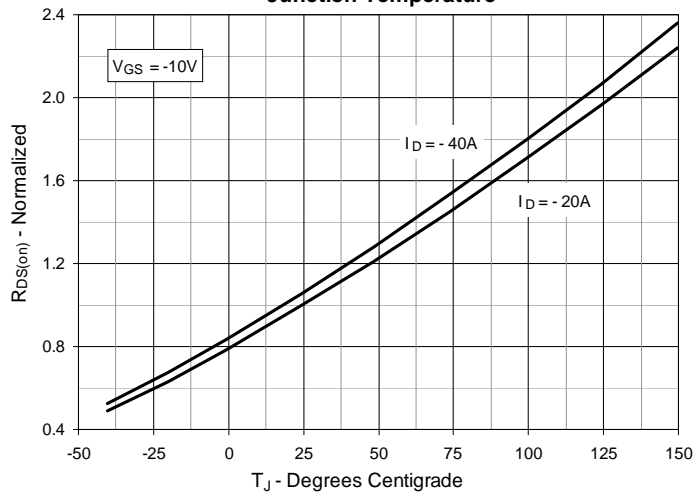
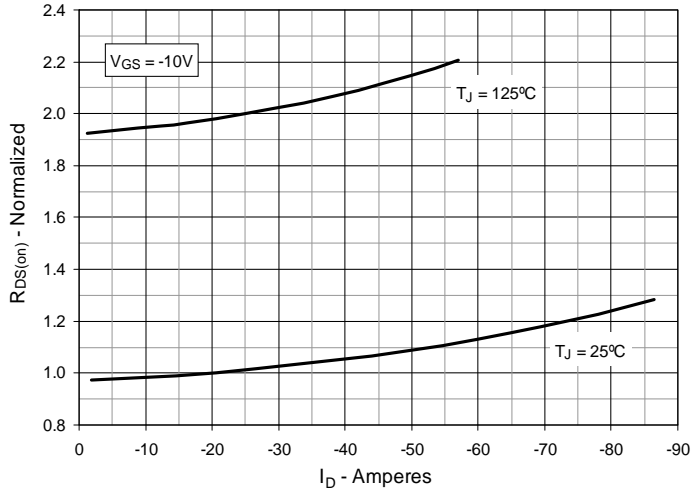
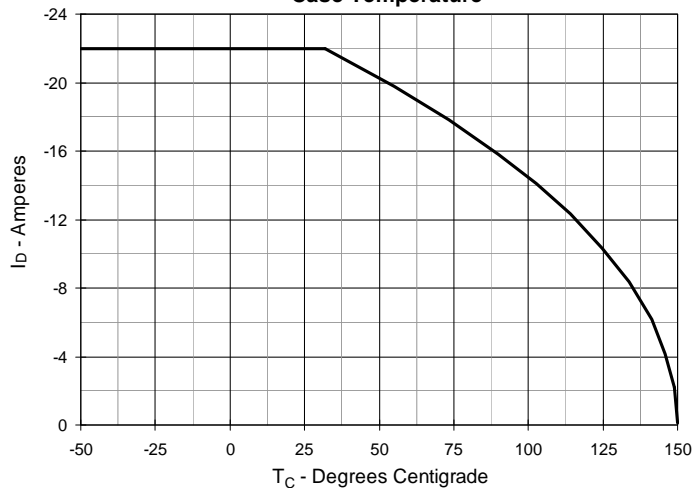
**Fig. 1. Output Characteristics @  $T_J = 25^\circ\text{C}$** 

**Fig. 2. Extended Output Characteristics @  $T_J = 25^\circ\text{C}$** 

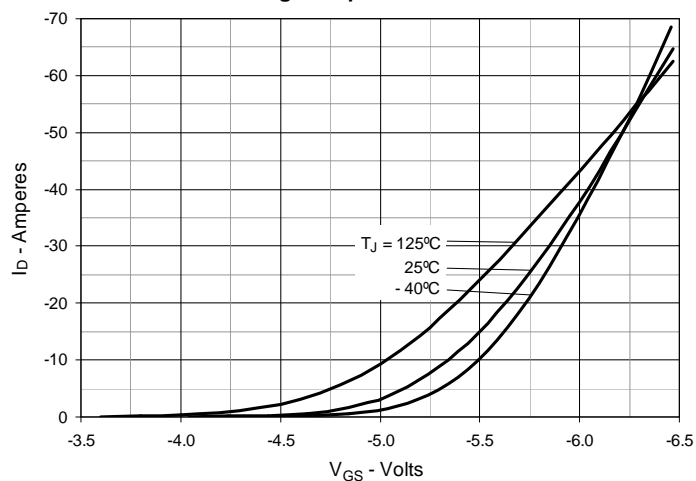
**Fig. 3. Output Characteristics @  $T_J = 125^\circ\text{C}$** 

**Fig. 4.  $R_{DS(on)}$  Normalized to  $I_D = -20\text{A}$  Value vs. Junction Temperature**

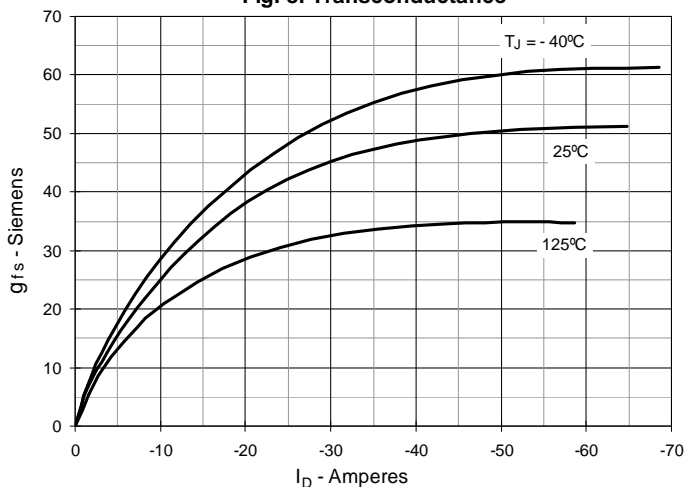
**Fig. 5.  $R_{DS(on)}$  Normalized to  $I_D = -20\text{A}$  Value vs. Drain Current**

**Fig. 6. Maximum Drain Current vs. Case Temperature**

**Fig. 7. Input Admittance**



**Fig. 8. Transconductance**



**Fig. 9. Forward Voltage Drop of Intrinsic Diode**

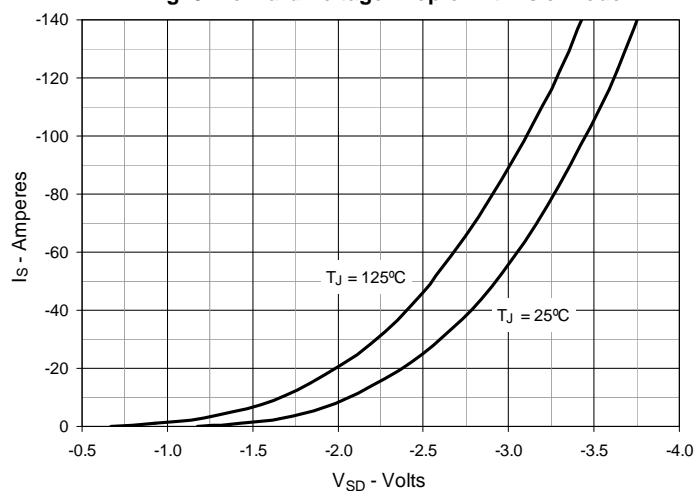

**Fig. 10. Gate Charge**

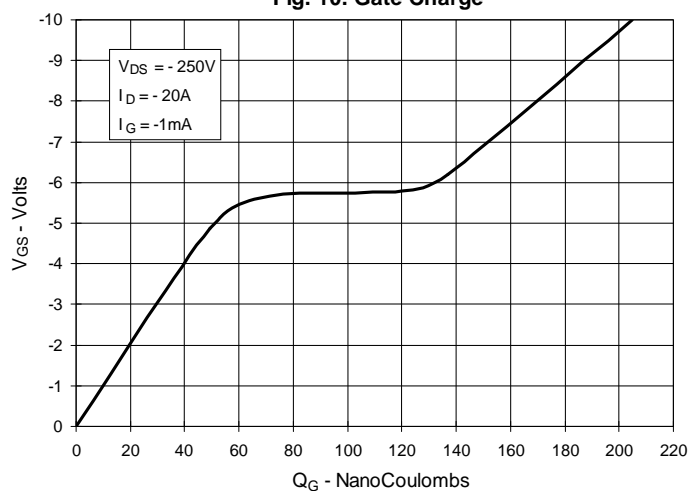

**Fig. 11. Capacitance**

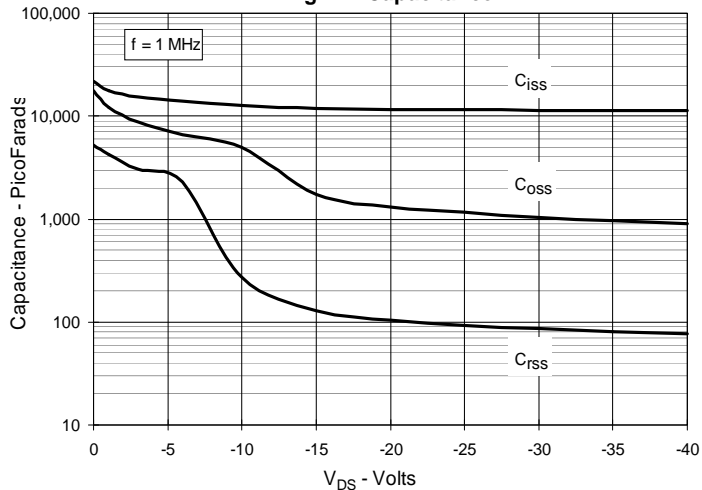

**Fig. 12. Forward-Bias Safe Operating Area**

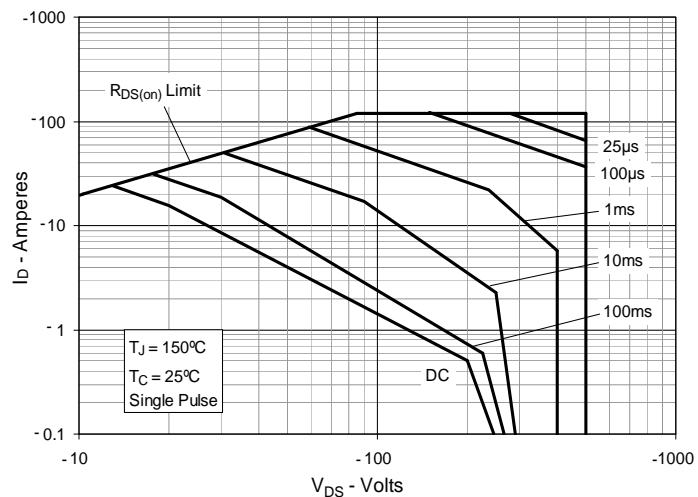
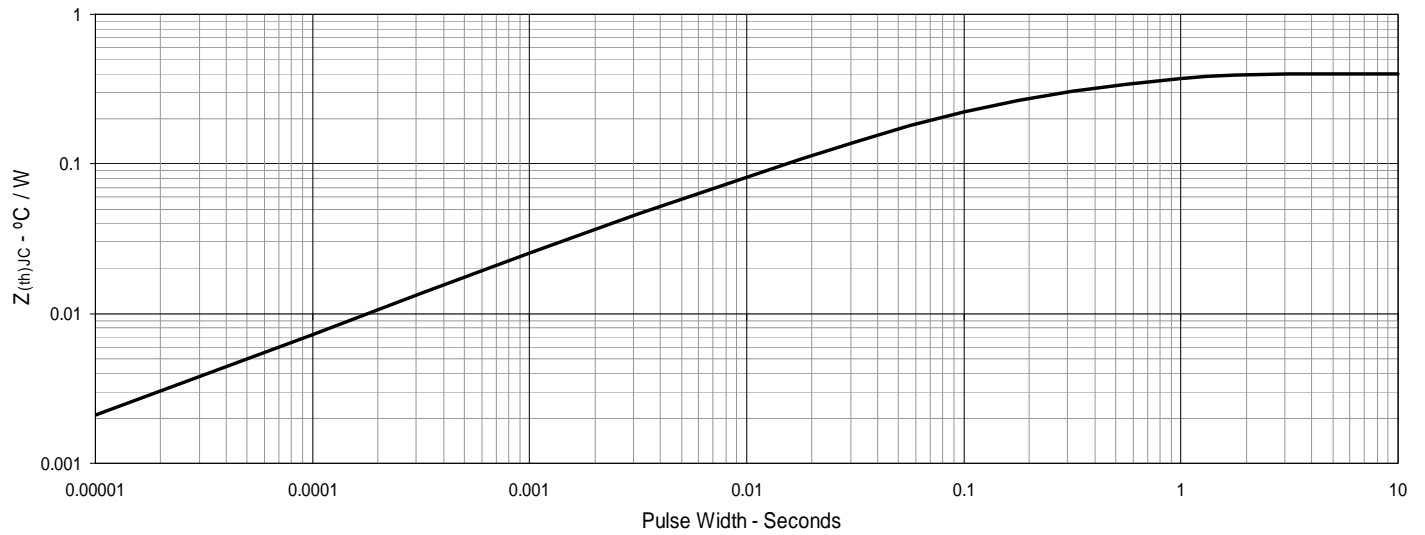

Fig. 13. Maximum Transient Thermal Impedance





---

Disclaimer Notice - Information furnished is believed to be accurate and reliable. However, users should independently evaluate the suitability of and test each product selected for their own applications. Littelfuse products are not designed for, and may not be used in, all applications. Read complete Disclaimer Notice at [www.littelfuse.com/disclaimer-electronics](http://www.littelfuse.com/disclaimer-electronics).

## Looking for pricing, stock, or lifecycle information?

Click below to explore more details on WIN SOURCE:

 [View IXTR40P50P on WIN SOURCE](#)

 [IXYS Information](#)

## Optimize Your Supply Chain with WIN SOURCE Solutions

-  Global Sourcing Solution
-  Obsolete Management
-  Cost Control Management
-  Shortage Management
-  Alternative Solution
-  Excess Inventory Management