



**THE DATASHEET OF  
DS4302Z-019**



## 2-Wire, 5-Bit DAC with Three Digital Outputs

### General Description

The DS4302 is a 5-bit digital-to-analog converter (DAC) with three programmable digital outputs. The DS4302 communicates through a 2-wire, SMBus™-compatible, serial interface. The tiny 8-pin  $\mu$ SOP package is ideal for use in space-constrained applications.

### Features

- ◆ SO Package is a Drop-In Replacement for the MPS1251 and MPS1252
- ◆ Single 5-Bit DAC (32 Steps)
- ◆ 0V to 2V and 0V to 1.9V Versions
- ◆ Three Programmable Digital Outputs
- ◆ SMBus-Compatible Serial Interface
- ◆ 4.5V to 5.5V Supply Voltage Range
- ◆ 8-Pin SO and 8-Pin  $\mu$ SOP Packages
- ◆ Industrial Temperature Range: -40°C to +85°C

DS4302

### Applications

CCFL Backlight Brightness Control  
Power-Supply Calibration

### Ordering Information

PART	V <sub>OUT</sub> RANGE	TOP BRAND	PIN-PACKAGE
DS4302Z-020	0V to 2.0V	4302B	8 SO
DS4302Z-019*	0V to 1.9V	4302A	8 SO
DS4302U-020	0V to 2.0V	4302B	8 $\mu$ SOP
DS4302U-019*	0V to 1.9V	4302A	8 $\mu$ SOP

Add "/T&R" for tape-and-reel orders.

\*Contact factory for availability.

### Pin Description

PIN	NAME	FUNCTION
1	SCL	Serial Clock Input. 2-wire clock input.
2	SDA	Serial Data Input/Output. Bidirectional, 2-wire data pin.
3	V <sub>OUT</sub>	DAC Output Voltage
4	GND	Ground
5	P2	Programmable Digital Output
6	P1	
7	P0	
8	V <sub>CC</sub>	Power-Supply Input

### Pin Configuration

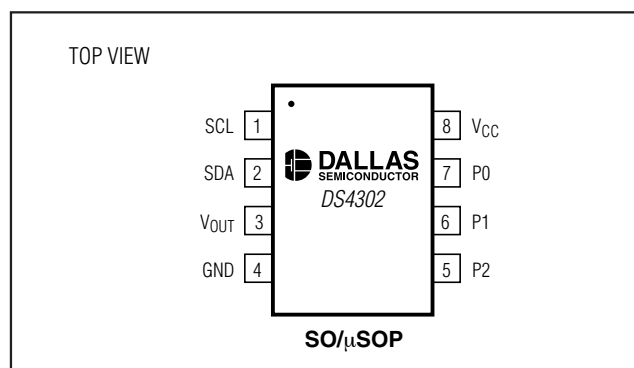

SMBus is a trademark of Intel Corp.

## 2-Wire, 5-Bit DAC with Three Digital Outputs

### ABSOLUTE MAXIMUM RATINGS

Voltage Range on V<sub>CC</sub>, SDA, and SCL Pins

Relative to Ground.....-0.5V to +6.0V

Operating Temperature Range .....-40°C to +85°C

Storage Temperature Range.....-55°C to +125°C

Soldering Temperature.....See IPC/JEDEC J-STD-020A Specification

*Stresses beyond those listed under "Absolute Maximum Ratings" may cause permanent damage to the device. These are stress ratings only, and functional operation of the device at these or any other conditions beyond those indicated in the operational sections of the specifications is not implied. Exposure to absolute maximum rating conditions for extended periods may affect device reliability.*

### RECOMMENDED DC OPERATING CONDITIONS

(T<sub>A</sub> = -40°C to +85°C)

PARAMETER	SYMBOL	CONDITIONS	MIN	TYP	MAX	UNITS
Supply Voltage	V <sub>CC</sub>	(Note 1)	4.5		5.5	V
Input Logic 1 (SDA, SCL)	V <sub>IH</sub>		2.0	V <sub>CC</sub> + 0.3		V
Input Logic 0 (SDA, SCL)	V <sub>IL</sub>		GND - 0.3		0.8	V

### DC ELECTRICAL CHARACTERISTICS

(V<sub>CC</sub> = +4.5V to 5.5V, T<sub>A</sub> = -40°C to +85°C.)

PARAMETER	SYMBOL	CONDITIONS	MIN	TYP	MAX	UNITS
Standby Current	I <sub>STBY</sub>	(Notes 2, 3)		200	300	μA
Input Leakage	I <sub>L</sub>	(Note 4)	-1.0		+1.0	μA
SDA Low-Level Output Voltage	V <sub>OL1</sub>	3mA sink current	0.0		0.4	V
		6mA sink current	0.0		0.6	
P0, P1, P2 Low-Level Output Voltage	V <sub>OL2</sub>	(Note 1) 4mA sink			+0.4V	V
P0, P1, P2 High-Level Output Voltage	V <sub>OH</sub>	(Note 1) 4mA source	V <sub>CC</sub> - 0.4V			V
V <sub>OUT</sub> Maximum Level (-020)		V <sub>CC</sub> = 5.0V, Data = 00000XXX (Note 3)	1.925	2.0	2.075	V
V <sub>OUT</sub> Minimum Level (-020)		V <sub>CC</sub> = 5.0V, Data = 11111XXX	0.0	0.05	0.1	V
V <sub>OUT</sub> Maximum Level (-019)		V <sub>CC</sub> = 5.0V, Data = 00000XXX (Note 3)	1.825	1.9	1.975	V
V <sub>OUT</sub> Minimum Level (-019)		V <sub>CC</sub> = 5.0V, Data = 11111XXX	0.0	0.05	0.1	V
Power-On Reset				1.7		V
Settling Time				10		μs
D/A Output Levels				32		steps

X = Don't care.

## 2-Wire, 5-Bit DAC with Three Digital Outputs

### AC ELECTRICAL CHARACTERISTICS (Figure 3)

( $V_{CC} = +4.5V$  to  $5.5V$ ,  $T_A = -40^{\circ}C$  to  $+85^{\circ}C$ , timing referenced to  $V_{IL(MAX)}$  and  $V_{IH(MIN)}$ .)

PARAMETER	SYMBOL	CONDITIONS	MIN	TYP	MAX	UNITS
SCL Clock Frequency	f <sub>SCL</sub>		0		400	kHz
Bus Free Time Between STOP and START Conditions	t <sub>BUF</sub>		1.3			μs
Low Period of SCL	t <sub>LOW</sub>		1.3			μs
High Period of SCL	t <sub>HIGH</sub>		0.6			μs
Data Hold Time	t <sub>HD:DAT</sub>		0		0.9	μs
Data Setup Time	t <sub>SU:DAT</sub>		100			ns
Start Setup Time	t <sub>SU:STA</sub>		0.6			μs
SDA and SCL Rise Time	t <sub>R</sub>	(Note 5)	20 + 0.1C <sub>B</sub>		300	ns
SDA and SCL Fall Time	t <sub>F</sub>	(Note 5)	20 + 0.1C <sub>B</sub>		300	ns
Stop Setup Time	t <sub>SU:STO</sub>		0.6			μs
SDA and SCL Capacitive Loading	C <sub>B</sub>	(Note 5)			400	pF

**Note 1:** All voltages referenced to ground.

**Note 2:** I<sub>STBY</sub> specified for the inactive state measured with SDA = SCL = V<sub>CC</sub> and with V<sub>OUT</sub>, P0, P1, and P2 floating.

**Note 3:** No load on V<sub>OUT</sub>.

**Note 4:** The DS4302 will not obstruct the SDA and SCL lines if V<sub>CC</sub> is switched off as long as the voltages applied to these inputs does not violate their min and max input-voltage levels.

**Note 5:** C<sub>B</sub>—total capacitance of one bus line in picofarads.

# 2-Wire, 5-Bit DAC with Three Digital Outputs

## Typical Operating Characteristics

( $V_{CC} = +5.0V$ ,  $T_A = +25^{\circ}C$ .)

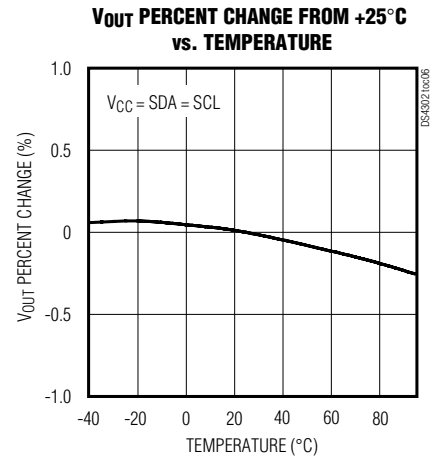
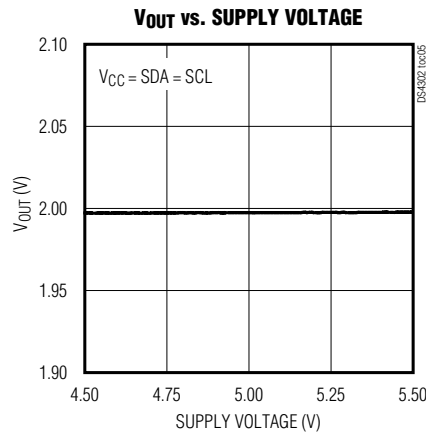
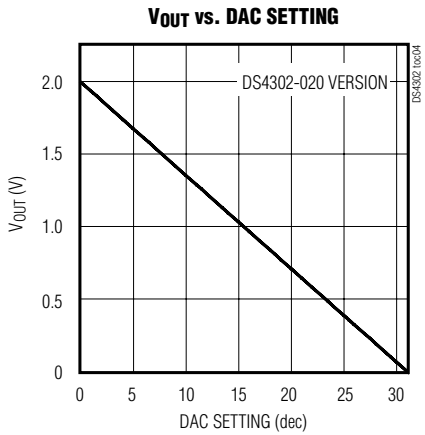
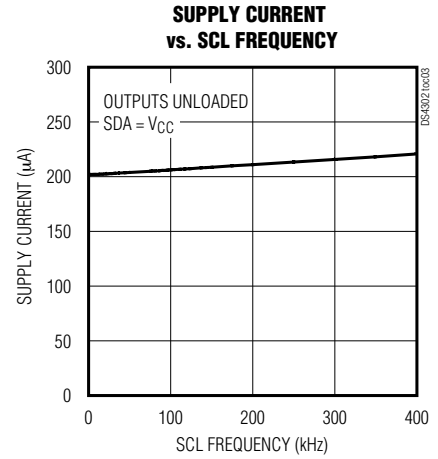
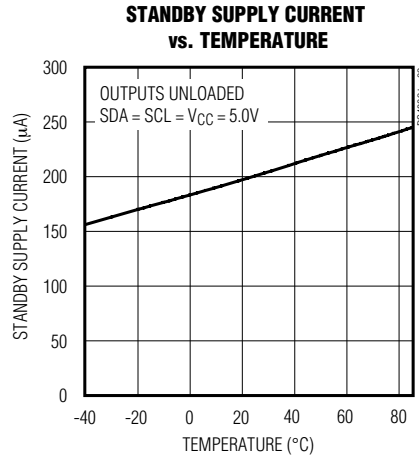
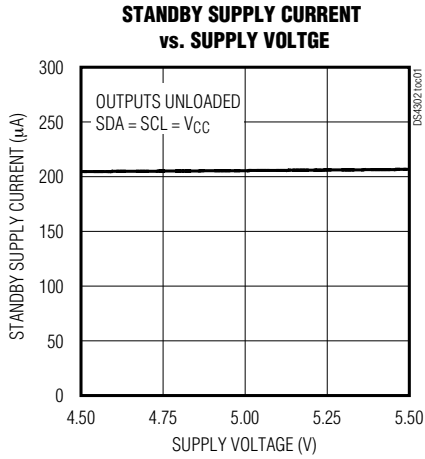

# 2-Wire, 5-Bit DAC with Three Digital Outputs

## Functional Diagram

DS4302

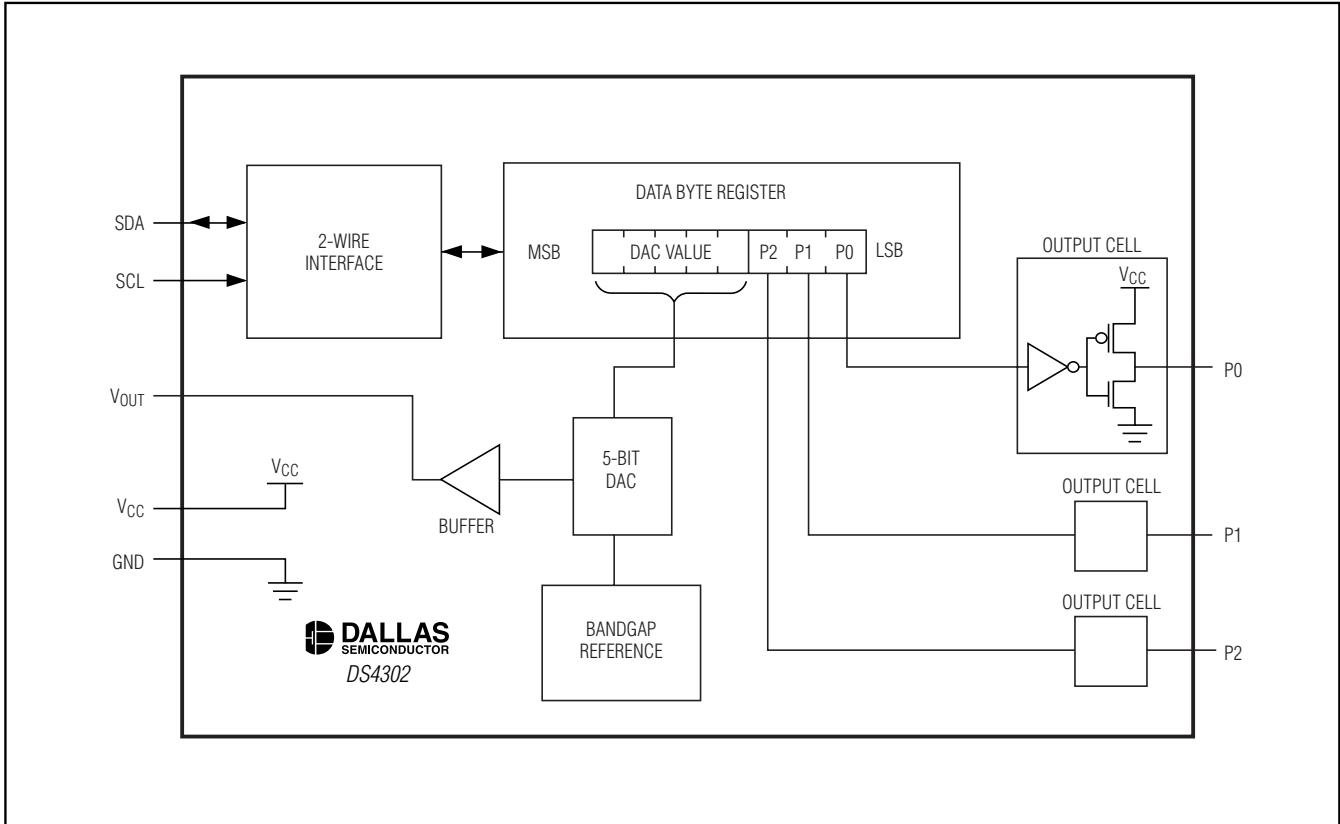

## 2-Wire, 5-Bit DAC with Three Digital Outputs

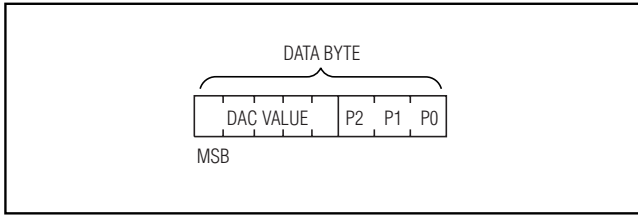

Figure 1. Data Byte Configuration

### Detailed Description

The DS4302 contains a 5-bit DAC and three programmable digital outputs. The DAC setting and the programmed output levels are contained in a 1-byte data word that defaults to 00h on power-up (see Figure 1 for data byte configuration). The upper 5 MSbits of the byte set the DAC and control the voltage produced on VOUT. A setting of 1111 1XXX sets the minimum output voltage from the DAC while a setting of 0000 0XXX sets the maximum output voltage from the DAC. The three LSbits of the data byte control the three output pins, P0, P1, and P2. Setting any of these control bits to a 0 pulls the corresponding outputs low and setting the bits to a 1 pulls the outputs high.

The DS4302 communicates through a 2-wire (SMBus-compatible) digital interface and has a 2-wire address of 58h. Write and read operations are used to access the DAC and output settings. Each operation begins with a 2-wire START condition, consists of three bytes, and ends with a 2-wire STOP condition (see Figure 2). Using the write operation, the 2-wire master can program the

5-bit DAC to adjust the voltage on VOUT and set the level of the three output pins: P0, P1, and P2. The read operation is used to recall the programmed settings.

### 2-Wire Definitions

The following terminology is commonly used to describe 2-wire data transfers.

**Master Device:** The master device controls the slave devices on the bus. The master device generates SCL clock pulses, START, and STOP conditions.

**Slave Devices:** Slave devices send and receive data at the master's request.

**Bus Idle or Not Busy:** Time between STOP and START conditions when both SDA and SCL are inactive and in their logic-high states. When the bus is idle, it initiates a low-power mode for slave devices.

**START Condition:** A START condition is generated by the master to initiate a new data transfer with a slave. Transitioning SDA from high to low while SCL remains high generates a START condition. See Figure 3 for applicable timing.

**STOP Condition:** A STOP condition is generated by the master to end a data transfer with a slave. Transitioning SDA from low to high while SCL remains high generates a STOP condition. See Figure 3 for applicable timing.

**Bit Write:** Transitions of SDA must occur during the low state of SCL. The data on SDA must remain valid and unchanged during the entire high pulse of SCL plus the setup and hold time requirements (see Figure 3). Data is shifted into the device during the rising edge of the SCL.

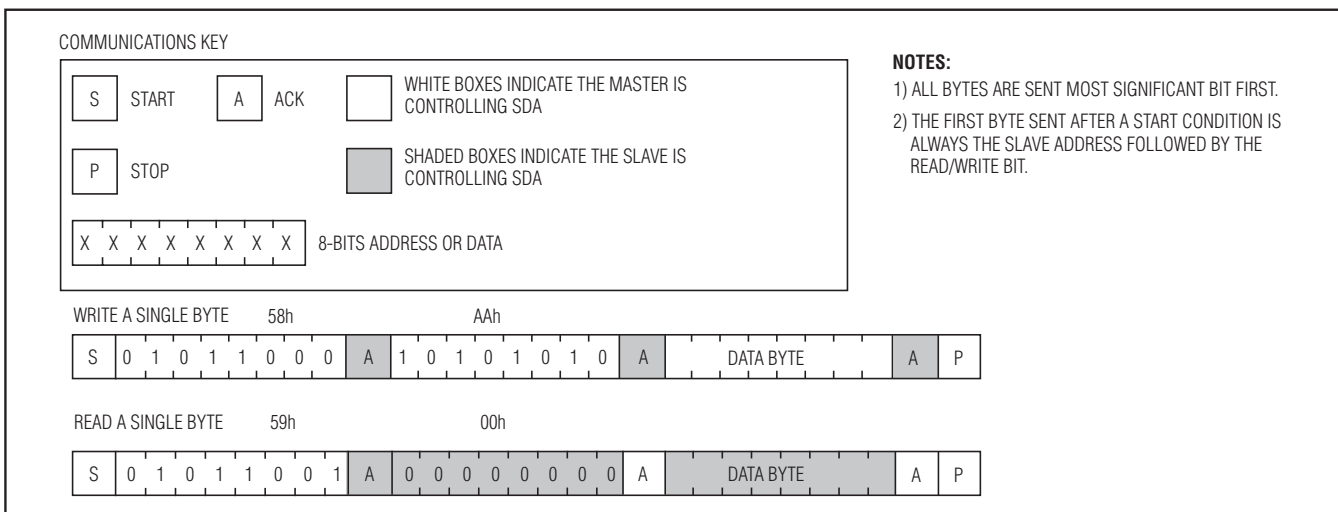

Figure 2. 2-Wire Communication Examples

## 2-Wire, 5-Bit DAC with Three Digital Outputs

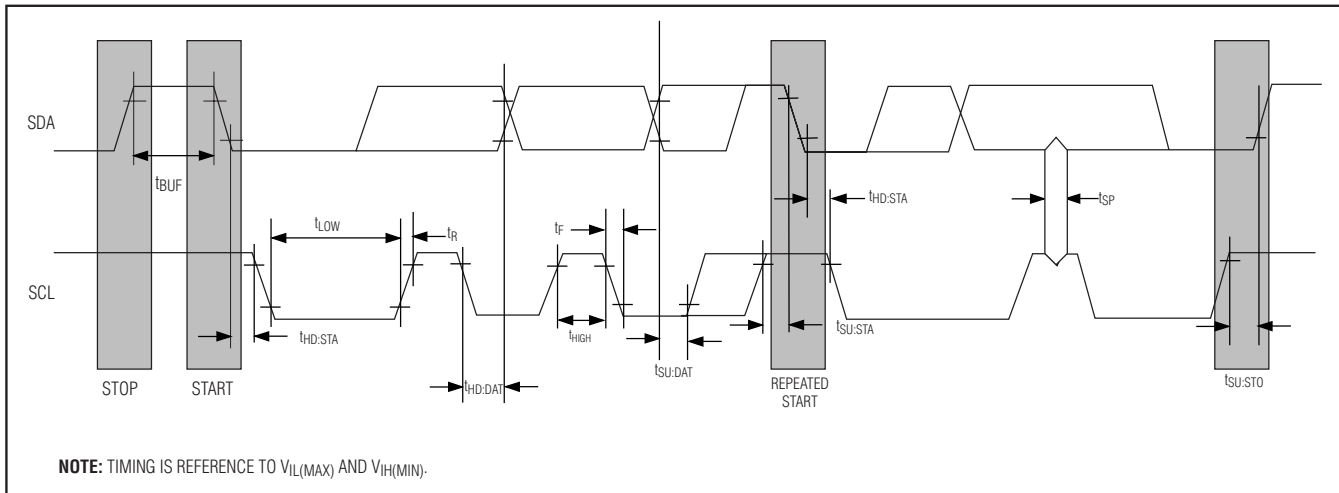

Figure 3. 2-Wire Timing Diagram

**Bit Read:** At the end a write operation, the master must release the SDA bus line for the proper amount of setup time (see Figure 3) before the next rising edge of SCL during a bit read. The device shifts out each bit of data on SDA at the falling edge of the previous SCL pulse and the data bit is valid at the rising edge of the current SCL pulse. Remember that the master generates all SCL clock pulses including when it is reading bits from the slave.

**Acknowledgement (ACK):** An Acknowledgement (ACK) is always the 9th bit transmitted during a byte transfer. The device receiving data (the master during a read or the slave during a write operation) performs an ACK by transmitting a zero during the 9th bit. For timing, see Figure 3. An ACK is the acknowledgement that the device is properly receiving data.

**Byte Write:** A byte write consists of 8 bits of information transferred from the master to the slave (most significant bit first) plus a 1-bit acknowledgement from the slave to the master. The 8 bits transmitted by the master are done according to the bit write definition and the acknowledgement is read using the bit read definition.

**Byte Read:** A byte read is an 8-bit information transfer from the slave to the master plus a 1-bit ACK from the master to the slave. The 8 bits of information that are transferred (most significant bit first) from the slave to the master are read by the master using the bit read definition above, and the master transmits an ACK using the bit write definition to receive additional data bytes. The master must ACK the last byte read to terminated communication so the slave returns control of SDA to the master.

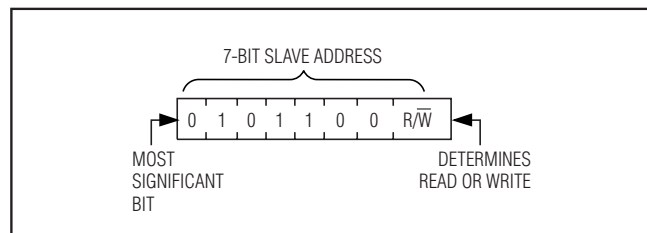

Figure 4. Slave Address and the R/W Bit

**Slave Address and the R/W Bit:** Each slave on the 2-wire bus responds to a slave addressing byte sent immediately following a START condition. The slave address byte contains the slave address and the R/W bit. The slave address (see Figure 4) is the most significant 7 bits and the R/W bit is the least significant bit.

The DS4302's slave address is 0101100X (binary), where X is the R/W bit. If the R/W bit is zero (01011000), the master will write data to the slave. If the R/W is a one (01011001), the master will read data from the slave.

**Memory Address:** During a 2-wire write operation, the master must transmit a memory address to identify the memory location where the slave is to store the data. The memory address is the second byte transmitted during a write or read operation following the slave address byte (R/W=0). For a write operation, the memory address is 10101010 (AAh) and for a read operation, the memory address is 00000000 (00h).

# 2-Wire, 5-Bit DAC with Three Digital Outputs

## 2-Wire Communication

**Writing to a Slave:** The master must generate a START condition, write the slave address ( $R/\overline{W} = 0$ ), write the memory address, write the byte of data, and generate a STOP condition. Remember the master must read the slave's acknowledgement during all byte-write operations. See Figure 2 for the write command example.

**Reading from a Slave:** To read from the slave, the master generates a START condition, writes the slave address with  $R/\overline{W} = 1$ , receives an ACK from the slave, reads a memory address of 00h from the slave, sends an ACK to the slave, reads the data byte, then sends an ACK to indicate the end of the transfer, and generates a STOP condition. See Figure 2 for the read command example.

## Application Information

### Power-Supply Decoupling

To achieve the best results when using the DS4302, decouple the power supply with a  $0.01\mu\text{F}$  or a  $0.1\mu\text{F}$  capacitor. Use high-quality, ceramic, surface-mount capacitors, and mount the capacitors as close as possible to the  $V_{CC}$  and GND pins of the DS4302 to minimize lead inductance.

### SDA and SCL Pullup Resistors

Pullup resistor values for SDA and SCL should be chosen to ensure that the rise and fall times listed in the AC electrical characteristics are within specification.

## Chip Information

TRANSISTOR COUNT: 2428

SUBSTRATE CONNECTED TO GROUND

## Package Information

For the latest package outline information, go to [www.maxim-ic.com/DallasPackInfo](http://www.maxim-ic.com/DallasPackInfo).

Maxim cannot assume responsibility for use of any circuitry other than circuitry entirely embodied in a Maxim product. No circuit patent licenses are implied. Maxim reserves the right to change the circuitry and specifications without notice at any time.

8 **Maxim Integrated Products, 120 San Gabriel Drive, Sunnyvale, CA 94086 408-737-7600**

© 2004 Maxim Integrated Products

Printed USA

**MAXIM** is a registered trademark of Maxim Integrated Products.



DALLAS is a registered trademark of Dallas Semiconductor Corporation.

## Looking for pricing, stock, or lifecycle information?

Click below to explore more details on WIN SOURCE:

 [View DS4302Z-019 on WIN SOURCE](#)

 [Maxim Integrated](#) Information

## Optimize Your Supply Chain with WIN SOURCE Solutions

-  Global Sourcing Solution
-  Obsolete Management
-  Cost Control Management
-  Shortage Management
-  Alternative Solution
-  Excess Inventory Management