



**THE DATASHEET OF
RI3-0505S/H3**



Features

Unregulated Converters

- 3 Watt in a SIP4 package
- 1kVDC/1s, 2kVDC/1s or 3kVDC/1s isolation
- Efficiency up to 90%
- -40°C to +100°C operating temperature range
- IEC/EN/UL60950 certified
- CB Report
- Industry standard pinout

RI3

**3 Watt
SIP4
Single Output**



UL60950-1 certified
CAN/CSA-C22.2 No 60950-1 certified
EN60950-1 certified
IEC60950-1 certified
EN55032 compliant
CB report

Description

The RI3 series has been specifically designed for applications where board space is at a premium since these 3 Watt converters have the same foot print as the RI series 2 Watt converters. With efficiencies up to 90%, the full output power is available over the operating temperature range -40°C to +85°C and the converters can be used in ambient temperatures of up to 100°C with derating. The wide selection of input voltage and output voltage options plus an I/O-Isolation of 1kVDC, 2kVDC or 3kVDC makes these converters suitable for many industrial applications.

Selection Guide

Part Number	Input Voltage [VDC]	Output Voltage [VDC]	Output Current [mA]	Efficiency typ. @ full load [%]	max. Capacitive Load ⁽¹⁾ [µF]
RI3-0505S	5	5	600	83	2200
RI3-0509S	5	9	333	86	1200
RI3-0512S	5	12	250	87	1000
RI3-0515S	5	15	200	88	820
RI3-1205S	12	5	600	85	2000
RI3-1209S	12	9	333	88	1200
RI3-1212S	12	12	250	89	1000
RI3-1215S	12	15	200	89	820
RI3-1505S	15	5	600	85	2000
RI3-1509S	15	9	333	88	1200
RI3-1512S	15	12	250	88	1000
RI3-1515S	15	15	200	88	820
RI3-2405S	24	5	600	86	2000
RI3-2409S	24	9	333	89	1200
RI3-2412S	24	12	250	90	1000
RI3-2415S	24	15	200	90	820

Notes:

Note1: Max. capacitive load is tested at nominal input and constant resistive load

Model Numbering



Notes:

Note2: add suffix "/H2" for 2kVDC/1second or "/H3" for 3kVDC/1second isolation without suffix standard 1kVDC/1second isolation

Ordering Examples:

- RI3-1212S = 12VDC Input Voltage, 12VDC Output Voltage, Single Output, 1kVDC/1s isolation
- RI3-2405S/H2 = 24VDC Input Voltage, 5VDC Output Voltage, Single Output, 2kVDC/1s isolation
- RI3-0505S/H3 = 5VDC Input Voltage, 5VDC Output Voltage, Single Output, 3kVDC/1s isolation

Specifications (measured @ Ta= 25°C, nom. Vin, full load and after warm-up unless otherwise stated)

BASIC CHARACTERISTICS

Parameter	Condition	Min.	Typ.	Max.
Input Voltage Range	5VDC	4.5VDC	5VDC	5.5VDC
	12VDC	10.8VDC	12VDC	13.2VDC
	15VDC	13.5VDC	15VDC	16.5VDC
	24VDC	21.6VDC	24VDC	26.4VDC
Internal Operating Frequency		20kHz	40kHz	
Minimum Load		0%		
Output Ripple and Noise ⁽³⁾	20MHz BW	50mVp-p	100mVp-p	

Notes:

Note3: Measurements are made with a 100nF MLCC across output (low ESR)

Efficiency vs. Load

RI3-05xxS

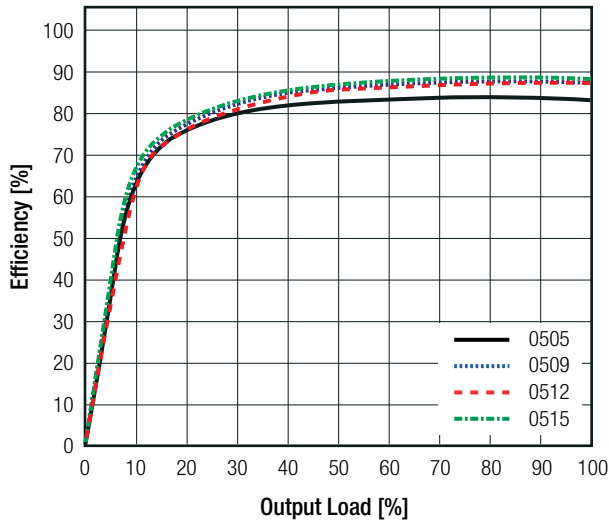

RI3-12xxS

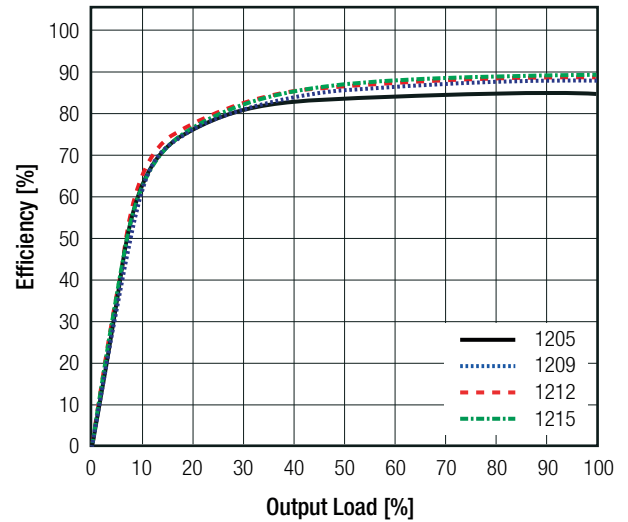

RI3-15xxS

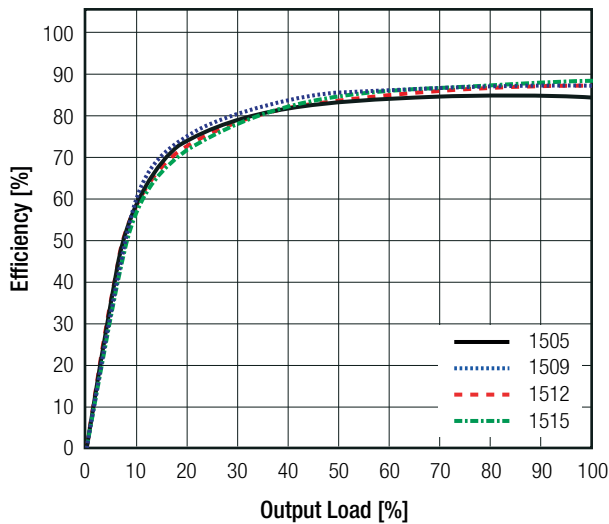

RI3-24xxS

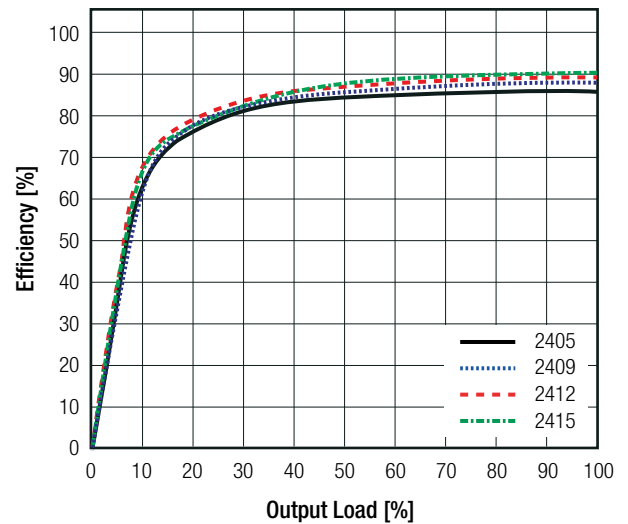

Specifications (measured @ Ta= 25°C, nom. Vin, full load and after warm-up unless otherwise stated)

REGULATIONS

Parameter	Condition		Values
Output Accuracy	5Vout all other		±3.0% min. / ±4.0% typ. ±2.0% min. / ±3.0% typ.
Line Regulation	low line to high line		±1.2% of 1.0% Vin typ.
Load Regulation ⁽⁴⁾	10% to 100% load	5Vout all other	±8.0% typ. / ±10.0% max. ±6.0% typ. / ±10.0% max.

Notes:

Note4: Operation below 10% load will not harm the converter, but specifications may not be met

Deviation vs. Load

RI3-xx05S

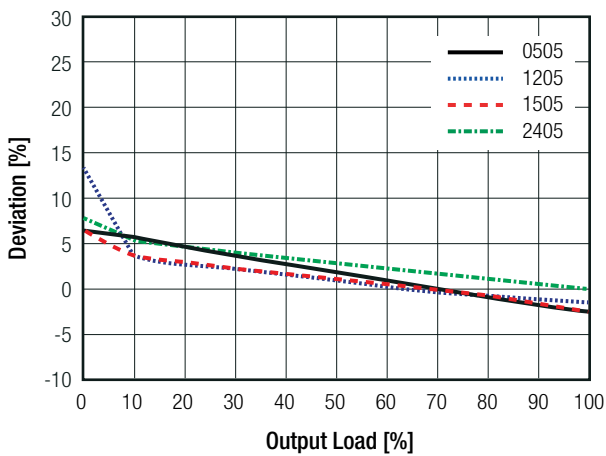

RI3-xx09S

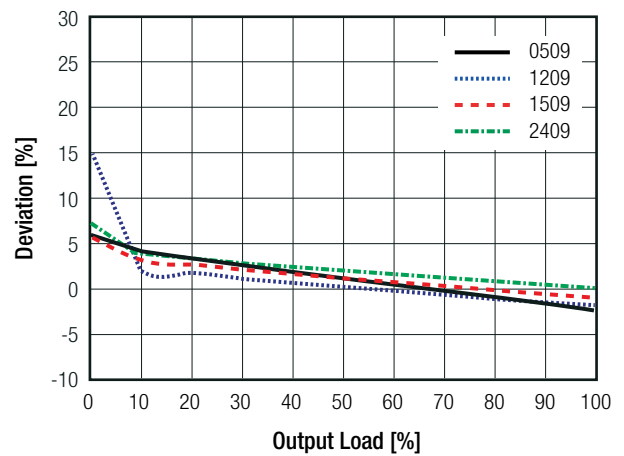

RI3-xx12S

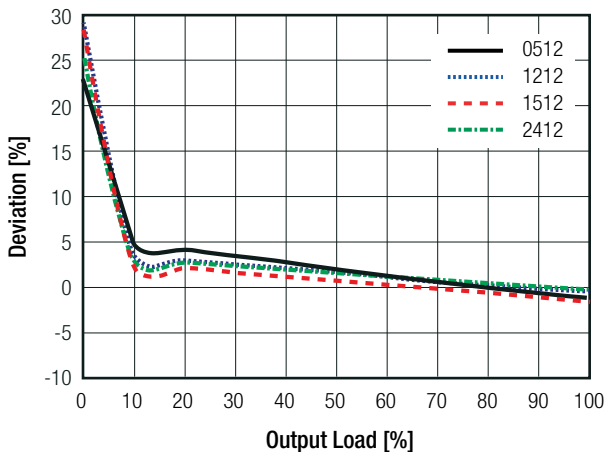

RI3-xx15S

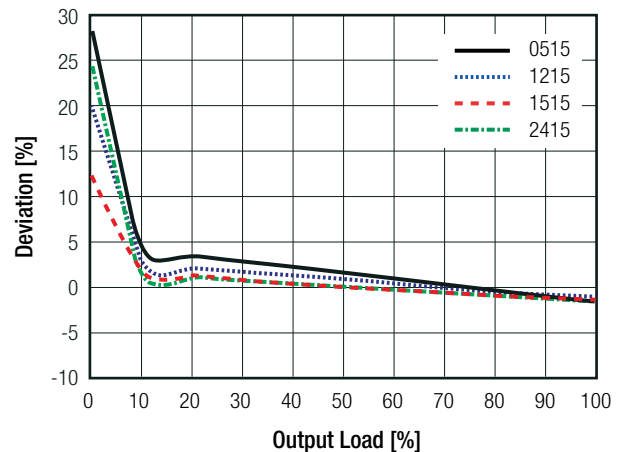

PROTECTIONS

Parameter	Condition		Value
Isolation Voltage	tested for 1 second	standard without suffix with suffix "/H2" with suffix "/H3"	1kVDC 2kVDC 3kVDC
Isolation Capacitance			37pF typ. / 130pF max.
Isolation Resistance			10GΩ min.

Specifications (measured @ $T_a = 25^\circ\text{C}$, nom. V_{in} , full load and after warm-up unless otherwise stated)

ENVIRONMENTAL			
Parameter	Condition		Value
Operating Temperature Range	without derating @ natural convection 0.1m/s (see graph)		-40°C to +85°C
Maximum Case Temperature			+115°C
Operating Humidity	non-condensing		5% - 95% RH max.
Vibration			MIL-STD-202G
MTBF	according to MIL-HDBK-217F, G.B.	+25°C	4395 x 10 ³ hours
		+85°C	1740 x 10 ³ hours

Derating Graph

(@ Chamber and natural convection 0.1 m/s)

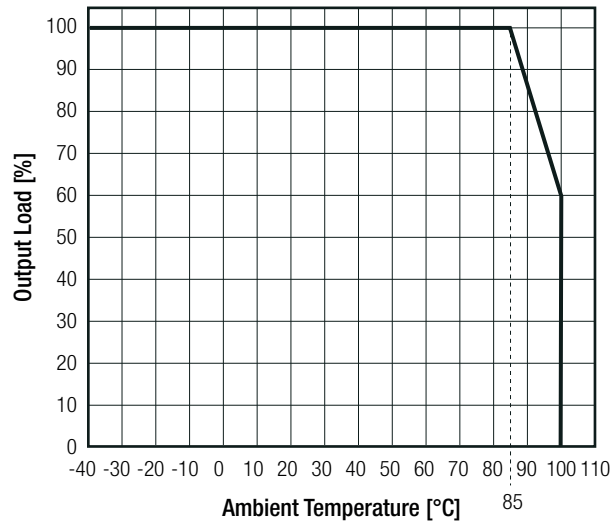

SAFETY AND CERTIFICATIONS

Certificate Type (Safety)	Report / File Number	Standard
Information Technology Equipment - General Requirements for Safety (CB Scheme)	E224736-A31-CB-1	IEC60950-1:2005, 2nd Edition + AM2:2013 EN60950-1, 2nd Edition, 2013
Information Technology Equipment - General Requirements for Safety	E224736-A32-UL	UL60950-1, 2nd Edition, 2014 CAN/CSA C22.2 No. 60950-1-07, 2nd Edition, 2014
EAC	RU-AT.49.09571	TP TC 004/2011
RoHS 2+		RoHS-2011/65/EU + AM-2015/863

EMC Compliance	Condition	Standard / Criterion
Electromagnetic compatibility of multimedia equipment - Emission requirements	with external filter (see filter suggestion below)	EN55032, Class B EN55032, Class A

EMC Filter Suggestion according to EN55032

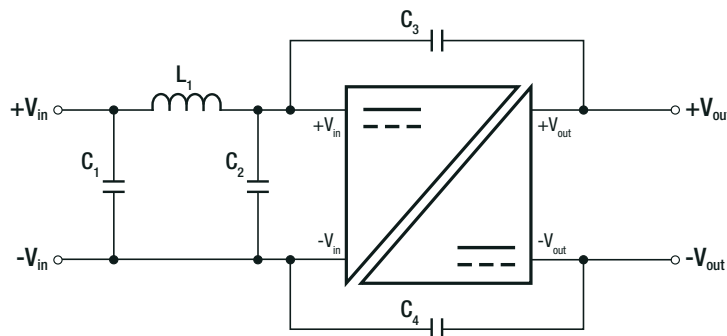

continued on next page

Specifications (measured @ Ta= 25°C, nom. Vin, full load and after warm-up unless otherwise stated)

Component List Class A

MODEL	C1	L1	C2
RI3-0505S	N/A	N/A	22µF, 16V MLCC
RI3-2405S			10µF, 100V MLCC
RI3-2412S			

Component List Class B

MODEL	C1	L1	C3 (safety)	C4 (safety)
RI3-0505S	10µF 100V MLCC	5.6µH choke RLS-567	470pF	330pF
RI3-2405S				
RI3-2415S				

Notes:

Note5: Filter suggestions are valid for indicated part numbers only. For other part numbers, please contact RECOM tech support for advice

DIMENSION and PHYSICAL CHARACTERISTICS

Parameter	Type	Value
Material	case potting	non-conductive plastic, (UL94 V-0) silicone, (UL94 V-0)
Dimension (LxWxH)		11.5 x 7.6 x 10.2mm
Weight		2.2g typ.

Dimension Drawing (mm)

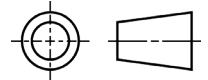
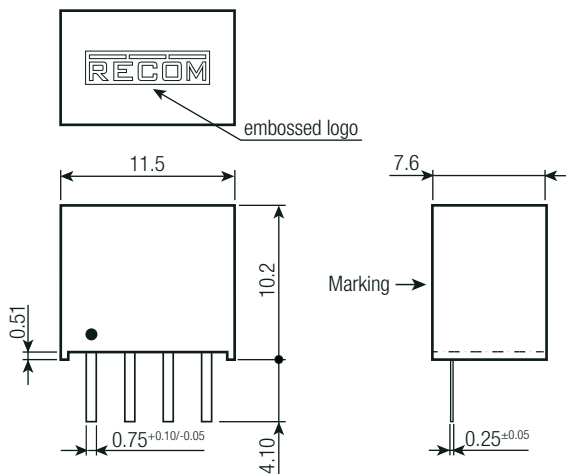

Pinning information

Pin #	Single
1	-Vin
2	+Vin
3	-Vout
4	+Vout

Tolerance:
xx.x= ±0.5mm
xx.xx= ±0.25mm

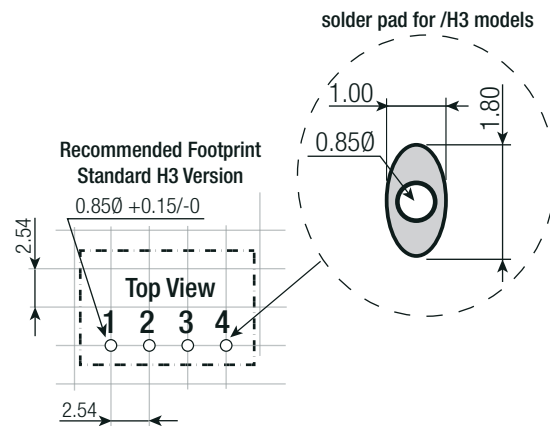
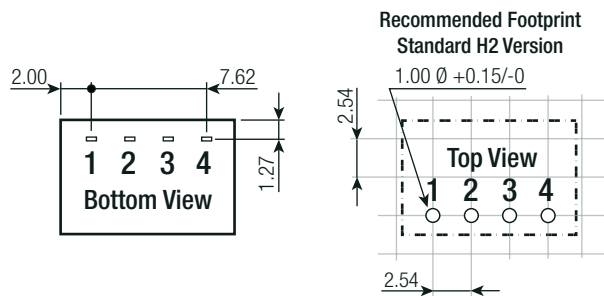

PACKAGING INFORMATION

Parameter	Type	Value
Packaging Dimension (LxWxH)	tube	520.0 x 16.5 x 9.0mm
Packaging Quantity	tube	42pcs
Storage Temperature Range		-55°C to +125°C
Storage Humidity	non-condensing	95% RH max.

The product information and specifications may be subject to changes even without prior written notice. The product has been designed for various applications; its suitability lies in the responsibility of each customer. The products are not authorized for use in safety-critical applications without RECOM's explicit written consent. A safety-critical application is an application where a failure may reasonably be expected to endanger or cause loss of life, inflict bodily harm or damage property. The applicant shall indemnify and hold harmless RECOM, its affiliated companies and its representatives against any damage claims in connection with the unauthorized use of RECOM products in such safety-critical applications.

Looking for pricing, stock, or lifecycle information?

Click below to explore more details on WIN SOURCE:

- [View RI3-0505S/H3 on WIN SOURCE](#)
- [Recom Power Information](#)

Optimize Your Supply Chain with WIN SOURCE Solutions

- ✓ Global Sourcing Solution
- ✓ Obsolete Management
- ✓ Cost Control Management
- ✓ Shortage Management
- ✓ Alternative Solution
- ✓ Excess Inventory Management