



**THE DATASHEET OF  
DM74ALS5245WM**



## DM74ALS5245 Octal 3-STATE Transceiver

### General Description

This octal bus transceiver is designed for asynchronous two-way communication between data buses. The inputs include hysteresis which provides improved noise rejection. Data is transmitted either from the A bus to the B bus or from the B bus to the A bus depending on the logic level of the direction control (DIR) input. The device can be disabled via the enable input (G) which causes the outputs to enter the high impedance mode so the buses are effectively isolated.

### Features

- Input Hysteresis
- Low output noise generation
- High input noise immunity
- Advanced oxide-isolated, ion implanted Schottky TTL process
- Switching specification guaranteed over the full temperature and  $V_{CC}$  range
- PNP inputs to reduce input loading

### Ordering Code:

Order Number	Package Number	Package Description
DM74ALS5245WM	M20B	20-Lead Small Outline Integrated Circuit (SOIC), JEDEC MS-013, 0.300 Wide
DM74ALS5245SJ	M20D	20-Lead Small Outline Package (SOP), EIAJ TYPE II, 5.3mm Wide
DM74ALS5245N	N20A	20-Lead Plastic Dual-In-Line Package (PDIP), JEDEC MS-001, 0.300 Wide

Devices also available in Tape and Reel. Specify by appending the suffix letter "X" to the ordering code.

### Connection Diagram

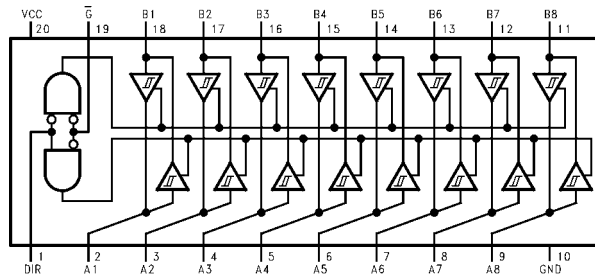

### Function Table

Control Inputs		Operation
$\bar{G}$	DIR	
L	L	B Data to A Bus
L	H	A Data to B Bus
H	X	High Impedance

L = LOW Logic Level    H = HIGH Logic Level    X = Don't Care (Either LOW or HIGH Logic Level)

**Absolute Maximum Ratings**(Note 1)

Supply Voltage	7V
Input Voltage	
Control Inputs	7V
I/O Ports	5.5V
Operating Free-Air Temperature Range	0°C to +70°C
Storage Temperature Range	-65°C to +150°C
Typical $\theta_{JA}$	
N Package	56.0°C/W
M Package	74.0°C/W

**Note 1:** The "Absolute Maximum Ratings" are those values beyond which the safety of the device cannot be guaranteed. The device should not be operated at these limits. The parametric values defined in the Electrical Characteristic tables are not guaranteed at the absolute maximum ratings. The "Recommended Operating Conditions" table will define the conditions for actual device operation.

**Recommended Operating Conditions**

Symbol	Parameter	Min	Max	Units
$V_{CC}$	Supply Voltage	4.5	5.5	V
$V_{IH}$	HIGH Level Input Voltage	2		V
$V_{IL}$	LOW Level Input Voltage		0.8	V
$I_{OH}$	HIGH Level Output Current		-15	mA
$I_{OL}$	LOW Level Output Current		24	mA
$T_A$	Free Air Operating Temperature Range	0	70	°C

**Electrical Characteristics**

over recommended free air temperature range. All typical values are measured at  $V_{CC} = 5V$ ,  $T_A = 25^\circ C$ .

Symbol	Parameter	Test Conditions	Min	Typ	Max	Units
$V_{IK}$	Input Clamp Voltage	$V_{CC} = \text{Min}$ , $I_I = -18 \text{ mA}$			-1.5	V
$H_{YS}$	Hysteresis ( $V_{T+} - V_{T-}$ )	$V_{CC} = \text{Min}$	0.2	0.32		V
$V_{OH}$	HIGH Level Output Voltage	$V_{CC} = 4.5V \text{ to } 5.5V$	$I_{OH} = -0.4 \text{ mA}$	$V_{CC} - 2$		V
		$V_{CC} = \text{Min}$	$I_{OH} = -3 \text{ mA}$	2.4	3.2	
			$I_{OH} = \text{Max}$	2		
$V_{OL}$	LOW Level Output Voltage	$V_{CC} = \text{Min}$	$I_{OL} = 12 \text{ mA}$	0.25	0.4	V
			$I_{OL} = 24 \text{ mA}$	0.35	0.5	
$I_I$	Input Current at Maximum Input Voltage	$V_{CC} = \text{Max}$	I/O Ports, $V_I = 5.5V$		100	$\mu A$
			Control Inputs, $V_I = 7V$		100	
$I_{IH}$	HIGH Level Input Current	$V_{CC} = \text{Max}$ , $V_I = 2.7V$			20	$\mu A$
$I_{IL}$	LOW Level Input Current	$V_{CC} = \text{Max}$ , $V_I = 0.4V$			-100	$\mu A$
$I_O$	Output Drive Current	$V_{CC} = \text{Max}$ , $V_O = 2.25V$	-30		-112	mA
$I_{CC}$	Supply Current	$V_{CC} = \text{Max}$	Outputs HIGH	30	45	mA
			Outputs LOW	36	55	
			Outputs Disabled	38	58	
$V_{OLP}$	Quiet Output Maximum Dynamic $V_{OL}$	$V_{CC} = 5.0V$ , $T_A = 25^\circ C$ (Figures 1, 2; (Note 2)(Note 3))		0.5		V
$V_{OLV}$	Quiet Output Minimum Dynamic $V_{OL}$	$V_{CC} = 5.0V$ , $T_A = 25^\circ C$ (Figures 1, 2; (Note 2)(Note 3))		-0.2		V
$V_{IHD}$	Minimum High Level Dynamic Input Voltage	$V_{CC} = 5.0V$ , $T_A = 25^\circ C$ (Note 2)(Note 4)		1.6		V
$V_{ILD}$	Maximum Low Level Dynamic Input Voltage	$V_{CC} = 5.0V$ , $T_A = 25^\circ C$ (Note 2)(Note 4)		1.0		V

**Note 2:** Plastic DIP package.

**Note 3:** n = number of device outputs; n-1 outputs switching, each driven 0V to 3V one output @ GND.

**Note 4:** n = number of device outputs; n outputs switching, n-1 inputs switching 0V to 3V. Input under test switching 3V to threshold ( $V_{ILD}$ ); 0V to threshold ( $V_{IHD}$ ); f = 1 MHz.

## Switching Characteristics

over recommended operating free air temperature range

Symbol	Parameter	Conditions	From (Input) To (Output)	Min	Max	Units
$t_{PLH}$	Propagation Delay Time LOW-to-HIGH Level Output	$V_{CC} = 4.5V$ to $5.5V$ , $R_1 = R_2 = 500\Omega$ , $C_L = 50$ pF	A or B to B or A	3	10	ns
$t_{PHL}$	Propagation Delay Time HIGH-to-LOW Level Output		A or B to B or A	3	10	ns
$t_{PZH}$	Output Enable Time to HIGH Level Output		$\bar{G}$ to A or B	5	20	ns
$t_{PZL}$	Output Enable Time to LOW Level Output		$\bar{G}$ to A or B	5	20	ns
$t_{PHZ}$	Output Disable Time from HIGH Level Output		$\bar{G}$ to A or B	2	10	ns
$t_{PLZ}$	Output Disable Time from LOW Level Output		$\bar{G}$ to A or B	4	15	ns

## ALS Noise Characteristics

The setup of a noise characteristics measurement is critical to the accuracy and repeatability of the tests. The following is a brief description of the setup used to measure the noise characteristics of ALS.

### Equipment:

- Word Generator
- Printed Circuit Board Test Fixture
- Dual Trace Oscilloscope

### Procedure:

1. Verify Test Fixture Loading: Standard Load 50 pF, 500Ω.
2. Deskew the word generator so that no two channels have greater than 150 ps skew between them. This requires that the oscilloscope be deskewed first. Swap out the channels that have more than 150 ps of skew until all channels being used are within 150 ps. It is important to deskew the word generator channels before testing. This will ensure that the outputs switch simultaneously.
3. Terminate all inputs and outputs to ensure proper loading of the outputs and that the input levels are at the correct voltage.
4. Set  $V_{CC}$  to 5.0V.
5. Set the word generator to toggle all but one output at a frequency of 1 MHz. Greater frequencies will increase DUT heating and affect the results of the measurement.
6. Set the word generator input levels at 0V LOW and 3V HIGH. Verify levels with a digital volt meter.

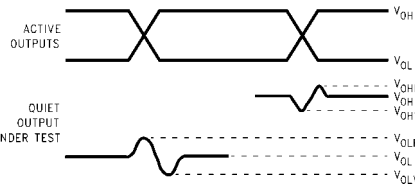

**FIGURE 1. Quiet Output Noise Voltage Waveforms**

**Note 5:**  $V_{OHV}$  and  $V_{OHP}$  are measured with respect to  $V_{OH}$  reference.  $V_{OLV}$  and  $V_{OLP}$  are measured with respect to ground reference.

**Note 6:** Input pulses have the following characteristics:  $f = 1$  MHz,  $t_r = 3$  ns,  $t_f = 3$  ns, skew < 150 ps.

$V_{OLP}/V_{OLV}$  and  $V_{OHP}/V_{OHV}$ :

- Determine the quiet output pin that demonstrates the greatest noise levels. The worst case pin will usually be the furthest from the ground pin. Monitor the output voltages using a 50Ω coaxial cable plugged into a standard SMB type connector on the test fixture. Do not use an active FET probe.
- Measure  $V_{OLP}$  and  $V_{OLV}$  on the quiet output during the HL transition. Measure  $V_{OHP}$  and  $V_{OHV}$  on the quiet output during the LH transition.
- Verify that the GND reference recorded on the oscilloscope has not drifted to ensure the accuracy and repeatability of the measurements.

$V_{ILD}$  and  $V_{IHD}$ :

- Monitor one of the switching outputs using a 50Ω coaxial cable plugged into a standard SMB type connector on the test fixture. Do not use an active FET probe.
- First increase the input LOW voltage level,  $V_{IL}$ , until the output begins to oscillate. Oscillation is defined as noise on the output LOW level that exceeds  $V_{IL}$  limits, or on output HIGH levels that exceed  $V_{IH}$  limits. The input LOW voltage level at which oscillation occurs is defined as  $V_{ILD}$ .
- Next decrease the input HIGH voltage level on the word generator,  $V_{IH}$  until the output begins to oscillate. Oscillation is defined as noise on the output LOW level that exceeds  $V_{IL}$  limits, or on output HIGH levels that exceed  $V_{IH}$  limits. The input HIGH voltage level at which oscillation occurs is defined as  $V_{IHD}$ .
- Verify that the GND reference recorded on the oscilloscope has not drifted to ensure the accuracy and repeatability of the measurements.

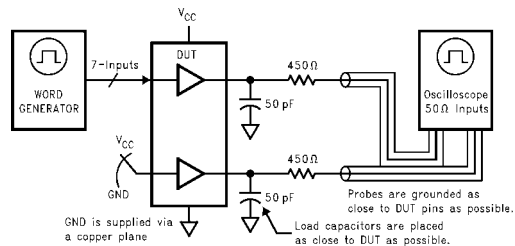

**FIGURE 2. Simultaneous Switching Test Circuit**

**Physical Dimensions** inches (millimeters) unless otherwise noted

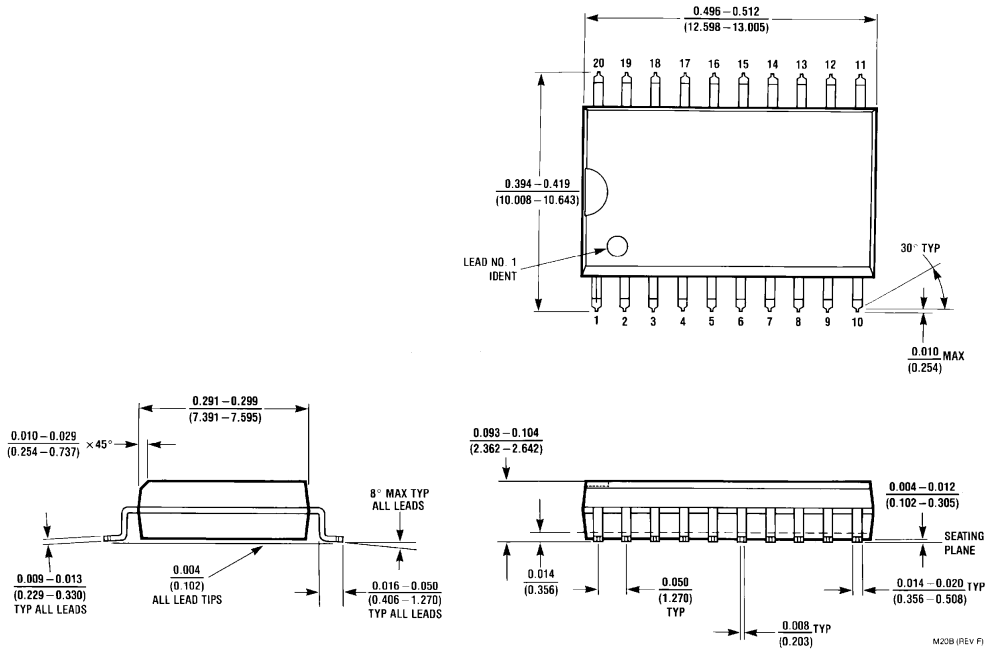

**20-Lead Small Outline Integrated Circuit (SOIC), JEDEC MS-013, 0.300 Wide  
Package Number M20B**

**Physical Dimensions** inches (millimeters) unless otherwise noted (Continued)

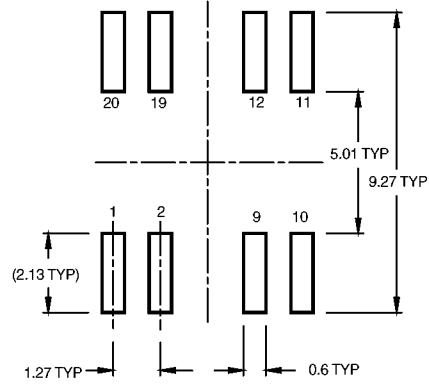
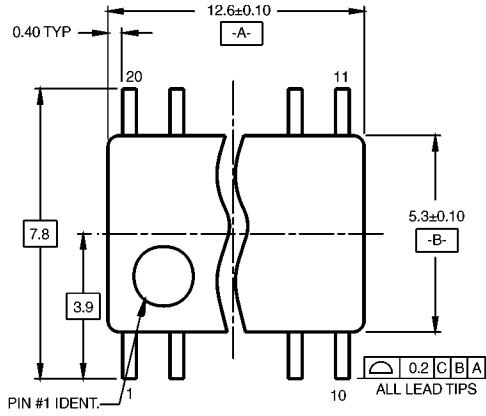

**LAND PATTERN RECOMMENDATION**

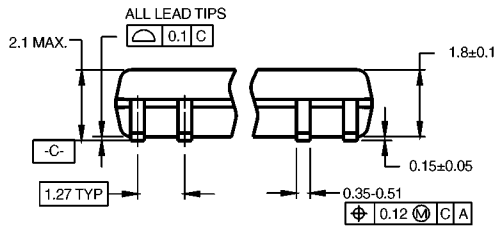

DIMENSIONS ARE IN MILLIMETERS

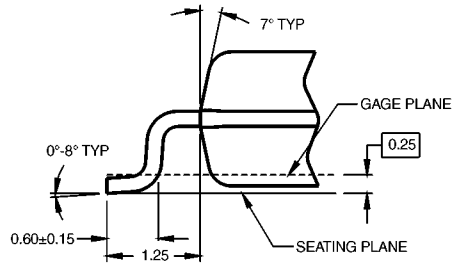
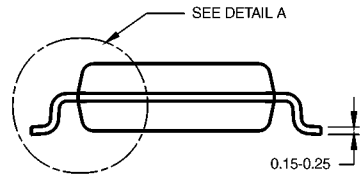

**DETAIL A**

**NOTES:**

- A. CONFORMS TO EIAJ EDR-7320 REGISTRATION, ESTABLISHED IN DECEMBER, 1998.
- B. DIMENSIONS ARE IN MILLIMETERS.
- C. DIMENSIONS ARE EXCLUSIVE OF BURRS, MOLD FLASH, AND TIE BAR EXTRUSIONS.

M20DRevB1

**20-Lead Small Outline Package (SOP), EIAJ TYPE II, 5.3mm Wide  
Package Number M20D**

**Physical Dimensions** inches (millimeters) unless otherwise noted (Continued)

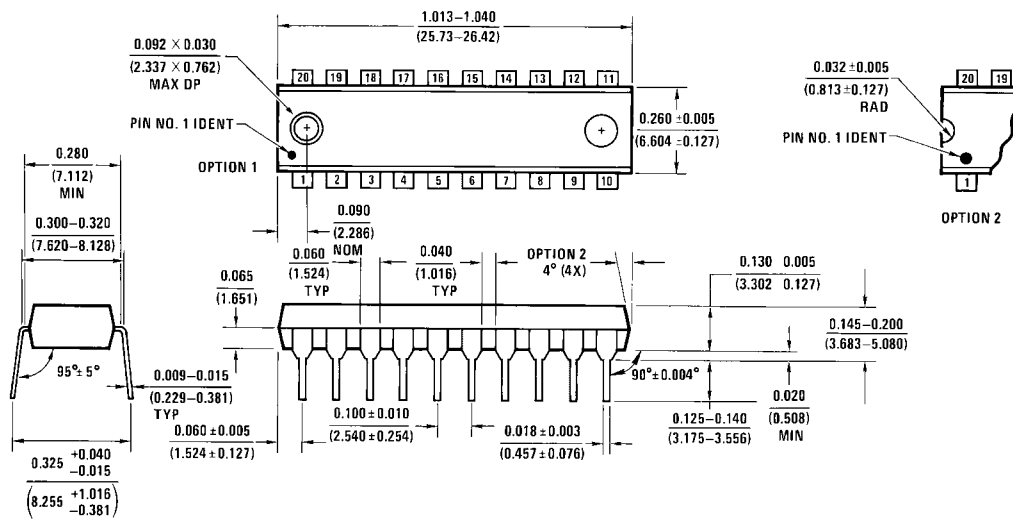

**20-Lead Plastic Dual-In-Line Package (PDIP), JEDEC MS-001, 0.300 Wide  
Package Number N20A**

Fairchild does not assume any responsibility for use of any circuitry described, no circuit patent licenses are implied and Fairchild reserves the right at any time without notice to change said circuitry and specifications.

**LIFE SUPPORT POLICY**



FAIRCHILD'S PRODUCTS ARE NOT AUTHORIZED FOR USE AS CRITICAL COMPONENTS IN LIFE SUPPORT DEVICES OR SYSTEMS WITHOUT THE EXPRESS WRITTEN APPROVAL OF THE PRESIDENT OF FAIRCHILD SEMICONDUCTOR CORPORATION. As used herein:

1. Life support devices or systems are devices or systems which, (a) are intended for surgical implant into the body, or (b) support or sustain life, and (c) whose failure to perform when properly used in accordance with instructions for use provided in the labeling, can be reasonably expected to result in a significant injury to the user.
2. A critical component in any component of a life support device or system whose failure to perform can be reasonably expected to cause the failure of the life support device or system, or to affect its safety or effectiveness.

[www.fairchildsemi.com](http://www.fairchildsemi.com)

## Looking for pricing, stock, or lifecycle information?

Click below to explore more details on WIN SOURCE:

-  [View DM74ALS5245WM on WIN SOURCE](#)
-  [Fairchild/ON Semiconductor Information](#)

## Optimize Your Supply Chain with WIN SOURCE Solutions

-  Global Sourcing Solution
-  Obsolete Management
-  Cost Control Management
-  Shortage Management
-  Alternative Solution
-  Excess Inventory Management