



**THE DATASHEET OF  
AP7345D-2833RH4-7**



## Description

The AP7345D is a Dual low dropout regulator with high output voltage accuracy, low  $R_{DS(ON)}$ , high PSRR, low output noise and low quiescent current. This regulator is based on a CMOS process.

Each of regulators includes a voltage reference, error amplifier, current limit circuit and an enable input to turn on/ off output. With the integrated resistor network fixed output voltage versions can be delivered.

With its low power consumption and line and load transient response, the AP7345D is well suited for low power handheld communication equipment.

The AP7345D is packaged in X2-DFN1612-8 package and allows for smallest footprint and dense PCB layout.

## Features

- Low  $V_{IN}$  and Wide  $V_{IN}$  Range: 1.7V to 5.25V
- Guarantee Each Channel Output Current: 300mA
- $V_{OUT}$  Accuracy  $\pm 1\%$
- Ripple Rejection: 75dB at 1kHz
- Low Output Noise: 60 $\mu$ Vrms from 10Hz to 100kHz
- Quiescent Current as Low as 50 $\mu$ A
- $V_{OUT}$  Fixed 1.2V to 3.6V
- **Totally Lead-Free & Fully RoHS Compliant (Notes 1 & 2)**
- **Halogen and Antimony Free, Green Device (Note 3)**

## Pin Assignments

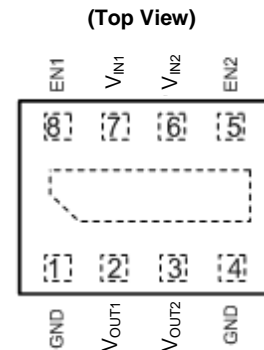

**X2-DFN1612-8**

## Applications

- Smart Phone/PAD
- RF Supply
- Cameras
- Portable Video
- Portable Media Player
- Wireless Adapter
- Wireless Communication

- Notes:
1. No purposely added lead. Fully EU Directive 2002/95/EC (RoHS), 2011/65/EU (RoHS 2) & 2015/863/EU (RoHS 3) compliant.
  2. See <https://www.diodes.com/quality/lead-free/> for more information about Diodes Incorporated's definitions of Halogen- and Antimony-free, "Green" and Lead-free.
  3. Halogen- and Antimony-free "Green" products are defined as those which contain <900ppm bromine, <900ppm chlorine (<1500ppm total Br + Cl) and <1000ppm antimony compounds.

## Typical Applications Circuit

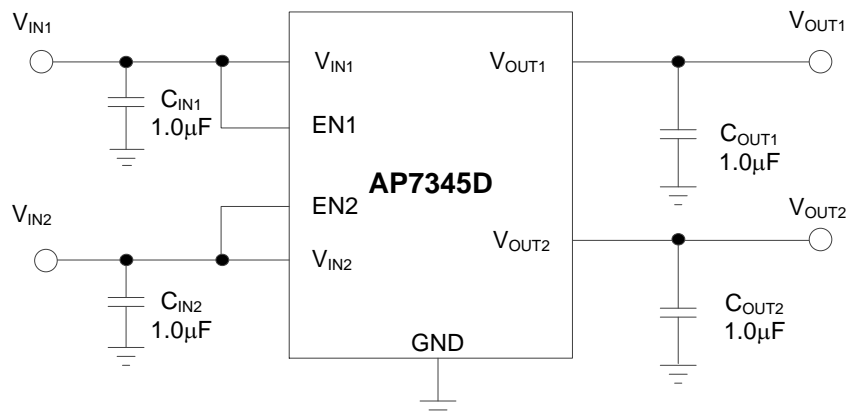

**Pin Descriptions**

| Pin Number        | Pin Name    | Function   |
|-------------------|-------------|--|
| GND               | 1, 4        | Ground   |
| V <sub>OUT1</sub> | 2           | Channel 1 Output Voltage pin   |
| V <sub>OUT2</sub> | 3           | Channel 2 Output Voltage pin   |
| EN2               | 5           | Channel 2 Enable pin. This pin should be driven either high or low and must not be floating. Driving this pin high enables channel 2 output, while pulling it low puts Channel 2 regulator into shutdown mode. |
| V <sub>IN2</sub>  | 6           | Channel 2 Input Voltage pin  |
| V <sub>IN1</sub>  | 7           | Channel 1 Input Voltage pin  |
| EN1               | 8           | Channel 1 Enable pin. This pin should be driven either high or low and must not be floating. Driving this pin high enables channel 1 output, while pulling it low puts Channel 1 regulator into shutdown mode. |
| —                 | Thermal PAD | In PCB layout, prefer to use large copper area to cover this pad for better thermal dissipation, then connect this area to GND or leave it open. However do not use it as GND electrode function alone.        |

NEW PRODUCT

**Functional Block Diagram**

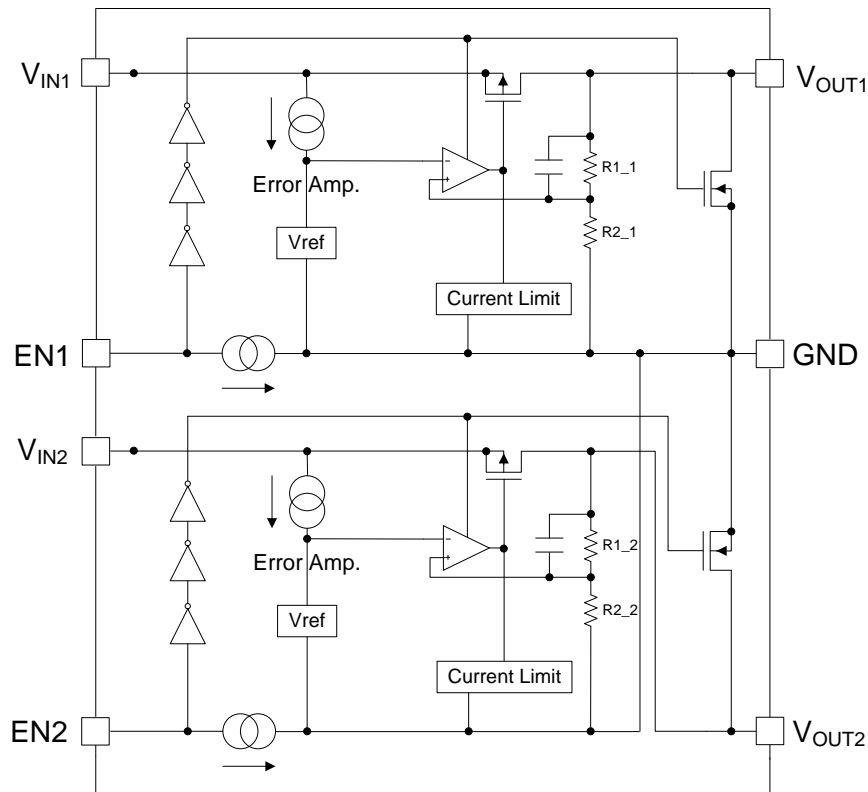

### Absolute Maximum Ratings (@T<sub>A</sub> = +25°C, unless otherwise specified. Note 4)

| Symbol           | Parameter                     | Rating                       | Unit |
|------------------|-------------------------------|------------------------------|------|
| V <sub>IN</sub>  | Input Voltage                 | 6.0                          | V    |
| V <sub>EN</sub>  | Input Voltage at EN Pins      | 6.0                          | V    |
| V <sub>OUT</sub> | Output Voltage                | -0.3 to V <sub>IN</sub> +0.3 | V    |
| I <sub>OUT</sub> | Output Current                | 400                          | mA   |
| P <sub>D</sub>   | Power Dissipation             | 600                          | mW   |
| T <sub>A</sub>   | Operating Ambient Temperature | -40 to +85                   | °C   |
| T <sub>STG</sub> | Storage Temperature           | -55 to +125                  | °C   |

Note 4: Stresses beyond those listed under Absolute Maximum Ratings may cause permanent damage to the device. These are stress ratings only and functional operation of the device at these conditions is not implied. Exposure to absolute-maximum-rated conditions for extended periods may affect device reliability.

### Recommended Operating Conditions (@T<sub>A</sub> = +25°C, unless otherwise specified.)

| Symbol           | Parameter                     | Min | Max  | Unit |
|------------------|-------------------------------|-----|------|------|
| V <sub>IN</sub>  | Input Voltage                 | 1.7 | 5.25 | V    |
| I <sub>OUT</sub> | Each Channel Output Current   | 0   | 300  | mA   |
| T <sub>A</sub>   | Operating Ambient Temperature | -40 | +85  | °C   |

**Electrical Characteristics** (@ $T_A = +25^\circ\text{C}$ ,  $V_{IN} = V_{OUT} + 1\text{V}$  ( $V_{OUT} > 1.5\text{V}$ ),  $V_{IN} = 2.5\text{V}$  ( $V_{OUT} \leq 1.5\text{V}$ ),  $I_{OUT} = 1\text{mA}$ ,  $C_{IN} = C_{OUT} = 1.0\mu\text{F}$ , unless otherwise specified.)

| Parameter  | Conditions   | Min  | Typ      | Max  | Unit                  |          |
|--|--|--|----------|------|-----------------------|----------|
| Input Voltage  | $T_A = -40^\circ\text{C}$ to $+85^\circ\text{C}$   | 1.7  | —        | 5.25 | V                     |          |
| Output Voltage Accuracy (Note 11)                          | $V_{IN} = (V_{OUT-Nom} + 1.0\text{V})$ to 5.25V,<br>$I_{OUT} = 1\text{mA}$ to 300mA                                  | $T_A = +25^\circ\text{C}$                        | -1       | —    | 1                     | %        |
|  |  | $T_A = -40^\circ\text{C}$ to $+85^\circ\text{C}$ | -1.5     | —    | 1.5                   |          |
| Line Regulation ( $\Delta V_{OUT}/\Delta V_{IN}/V_{OUT}$ ) | $V_{IN} = (V_{OUT-Nom} + 1.0\text{V})$ to 5.25V, $I_{OUT} = 1.0\text{mA}$  | —  | 0.02     | 0.1  | %/V                   |          |
| Load Regulation  | $V_{IN} = V_{OUT-Nom} + 1.0\text{V}$ , $I_{OUT} = 1\text{mA}$ to 300mA   | —  | 15       | 30   | mV                    |          |
| Quiescent Current (Note 6)                                 | Set EN1 High, Set EN2 Low, or Set EN2 High,<br>Set EN1 Low, No Load  | —  | 50       | 70   | $\mu\text{A}$         |          |
|  | Set EN1/EN2 High, No Load  | —  | 100      | 140  | $\mu\text{A}$         |          |
| $I_{STANDBY}$  | Set EN1/EN2 Low, No Load   | —  | 0.1      | 1.0  | $\mu\text{A}$         |          |
| Each Channel Output Current                                | —  | 300  | —        | —    | mA                    |          |
| Fold-back Short Current (Note 7)                           | $V_{OUT}$ short to ground  | —  | 55       | —    | mA                    |          |
| PSRR (Note 8)  | $V_{IN} = (V_{OUT} + 1\text{V}) V_{DC} + 0.2\text{Vp-pAC}$ ,<br>$V_{OUT} \geq 1.8\text{V}$ , $I_{OUT} = 30\text{mA}$ | $f = 1\text{kHz}$                                | —        | 75   | —                     | dB       |
| Output Noise Voltage (Notes 8 & 9)                         | BW = 10Hz to 100kHz, $I_{OUT} = 30\text{mA}$   | —  | 60       | —    | $\mu\text{Vrms}$      |          |
| Dropout Voltage (Note 5)                                   | $I_{OUT} = 300\text{mA}$   | $V_{OUT} \leq 1.2\text{V}$                       | —        | 0.46 | 0.70                  | V        |
|  |  | $1.2\text{V} < V_{OUT} \leq 1.4\text{V}$         | —        | 0.39 | 0.58                  |          |
|  |  | $1.4\text{V} < V_{OUT} \leq 1.7\text{V}$         | —        | 0.35 | 0.44                  |          |
|  |  | $1.7\text{V} < V_{OUT} \leq 2.1\text{V}$         | —        | 0.30 | 0.39                  |          |
|  |  | $2.1\text{V} < V_{OUT} \leq 2.5\text{V}$         | —        | 0.26 | 0.34                  |          |
|  |  | $2.5\text{V} < V_{OUT} \leq 3.0\text{V}$         | —        | 0.25 | 0.30                  |          |
|  |  | $3.0\text{V} < V_{OUT} \leq 3.6\text{V}$         | —        | 0.22 | 0.29                  |          |
| Output Voltage Temperature Coefficient                     | $I_{OUT} = 30\text{mA}$ , $T_A = -40^\circ\text{C}$ to $+85^\circ\text{C}$   | —  | $\pm 30$ | —    | ppm/ $^\circ\text{C}$ |          |
| Thermal Shutdown Threshold (TSHDN)                         | —  | —  | +150     | —    | $^\circ\text{C}$      |          |
| Thermal Shutdown Hysteresis (THYS)                         | —  | —  | +20      | —    | $^\circ\text{C}$      |          |
| EN Input Low Voltage                                       | —  | 0  | —        | 0.5  | V                     |          |
| EN Input High Voltage                                      | —  | 1.3  | —        | 5.25 | V                     |          |
| EN Input Leakage   | $V_{EN} = 0\text{V}$ , $V_{IN} = 5.0\text{V}$ or $V_{EN} = 5.0\text{V}$ , $V_{IN} = 0\text{V}$                       | -1.0   | —        | 1.0  | $\mu\text{A}$         |          |
| On Resistance of N-channel for Auto-discharge (Note 10)    | $V_{IN} = 4.0\text{V}$ , $V_{EN} = 0\text{V}$ (Disabled)   | D Version, Chanel 1 & 2                          | —        | 30   | —                     | $\Omega$ |

- Notes:
- Dropout voltage is the voltage difference between the input and the output at which the output voltage drops 2% below its nominal value.
  - Quiescent current is defined here is the difference in current between the input and the output.
  - Short circuit current is measured with  $V_{OUT}$  pulled to GND.
  - This specification is guaranteed by design.
  - To make sure lowest environment noise minimizes the influence on noise measurement.
  - AP7345D has 2 options for output, built-in discharge and non-discharge.
  - Potential multiple grades based on following output voltage accuracy.

**Performance Characteristics**

NEW PRODUCT

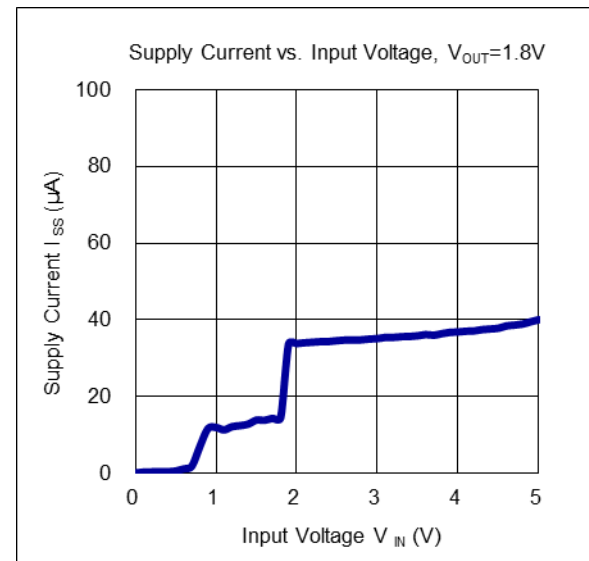
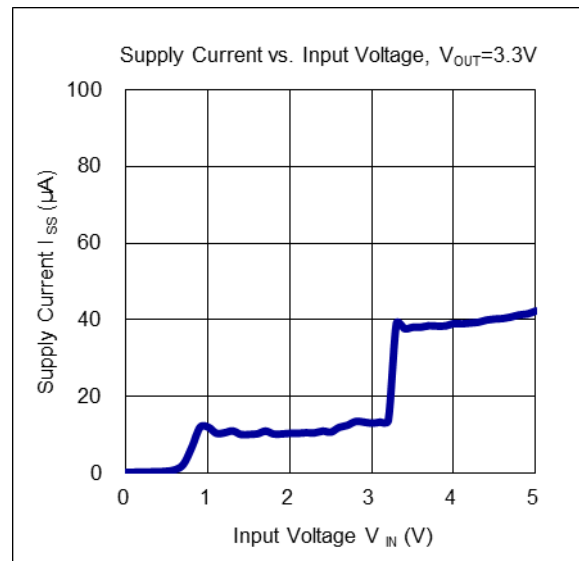
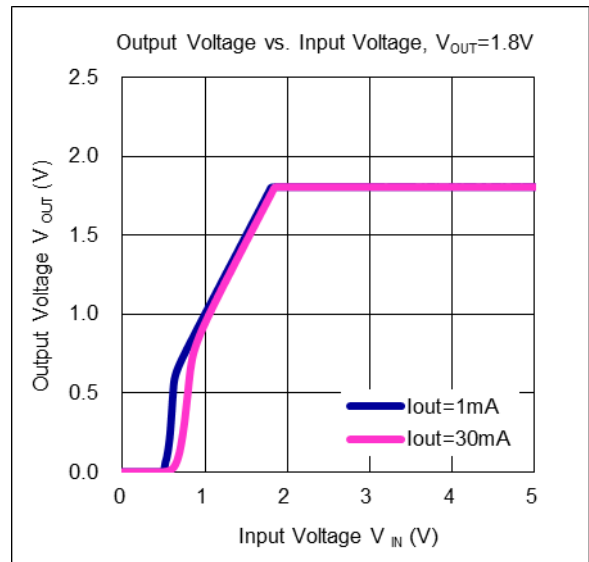
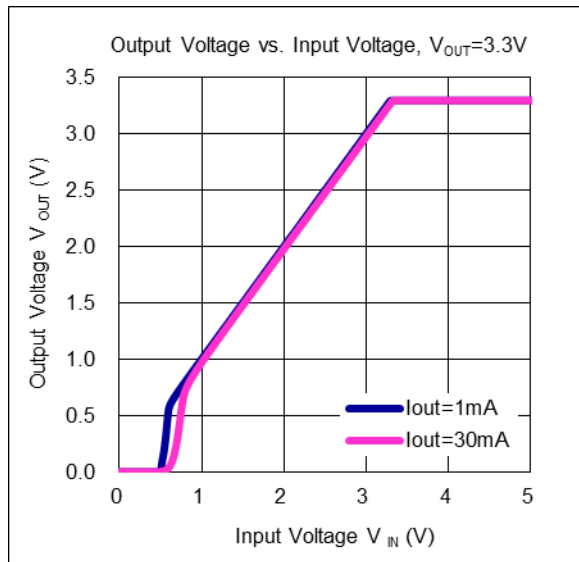
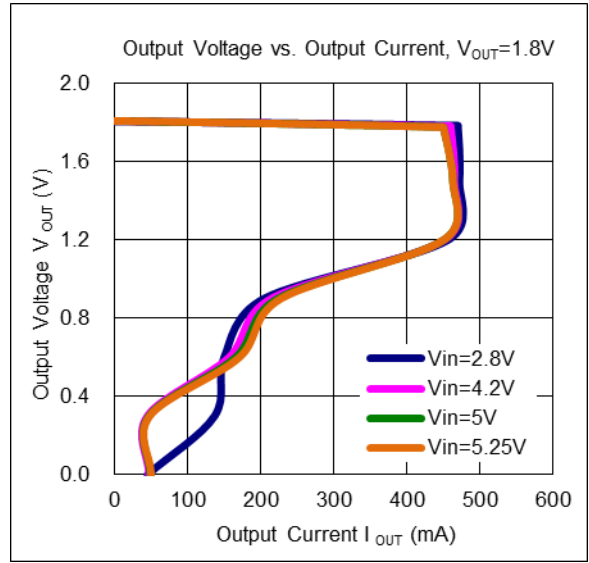
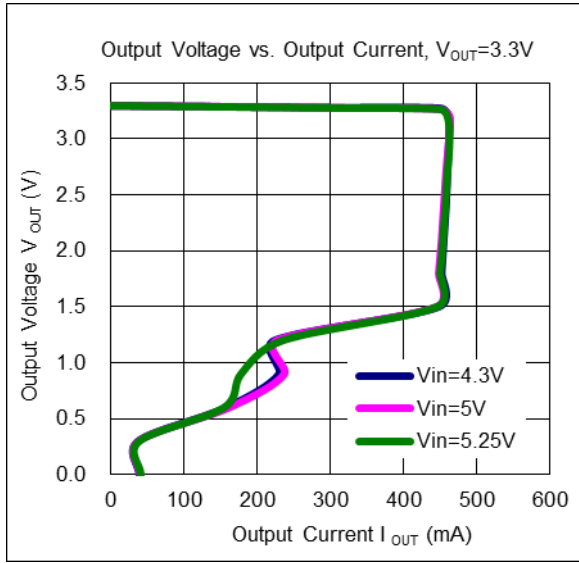

Performance Characteristics (Cont.)

NEW PRODUCT

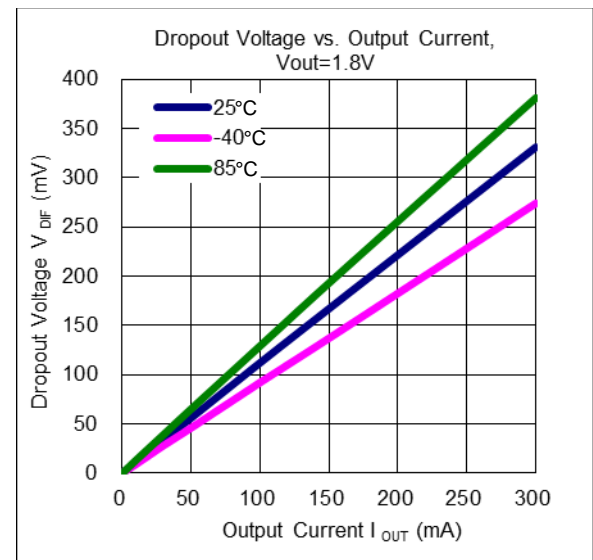
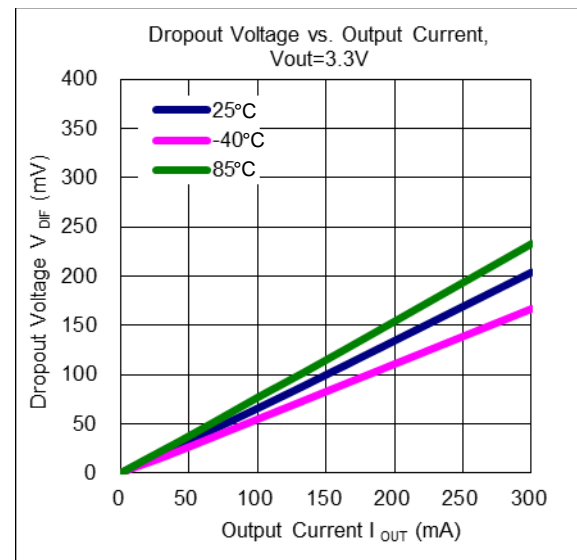
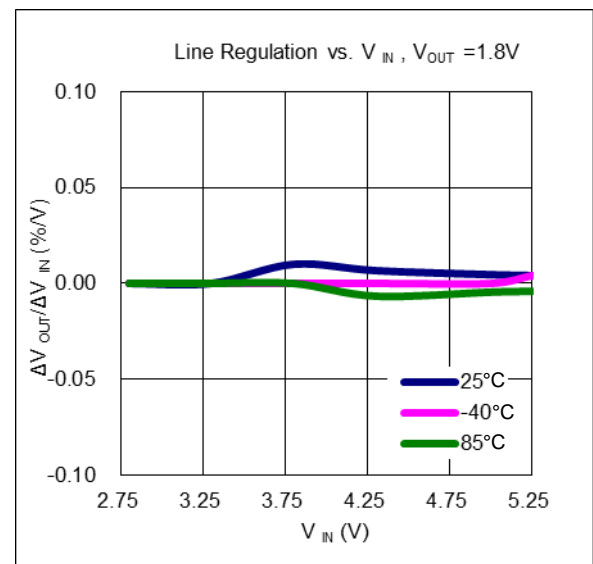
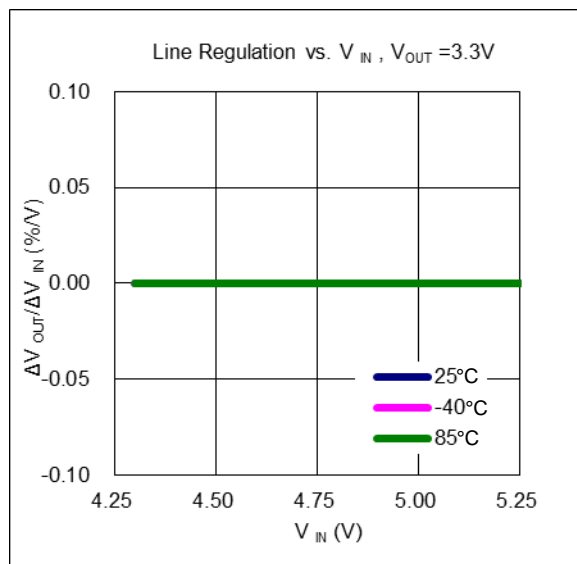
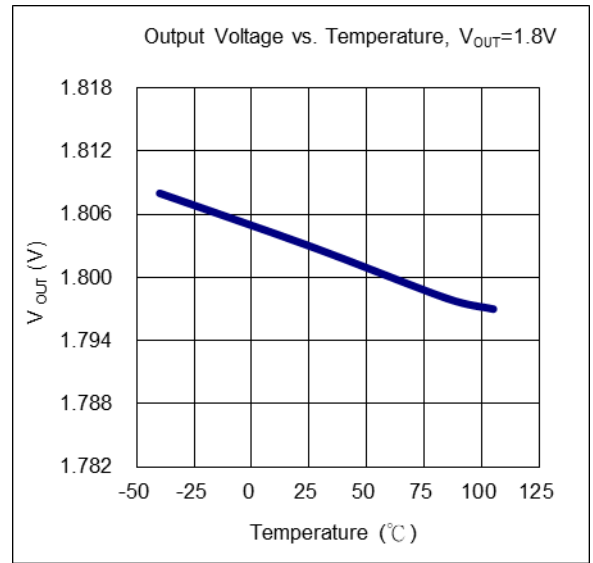
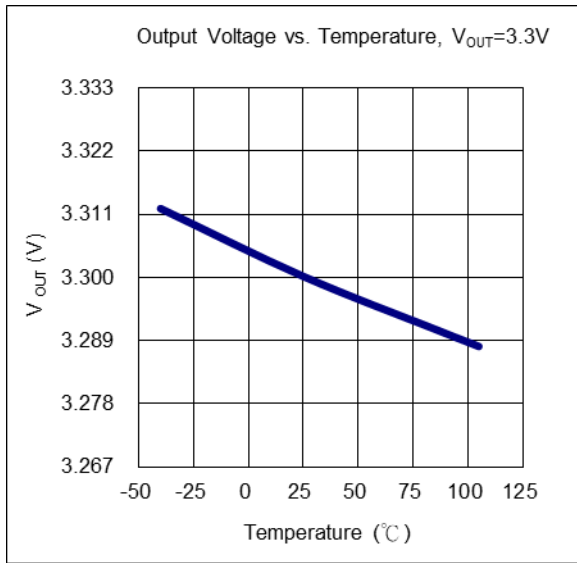

Performance Characteristics (Cont.)

NEW PRODUCT

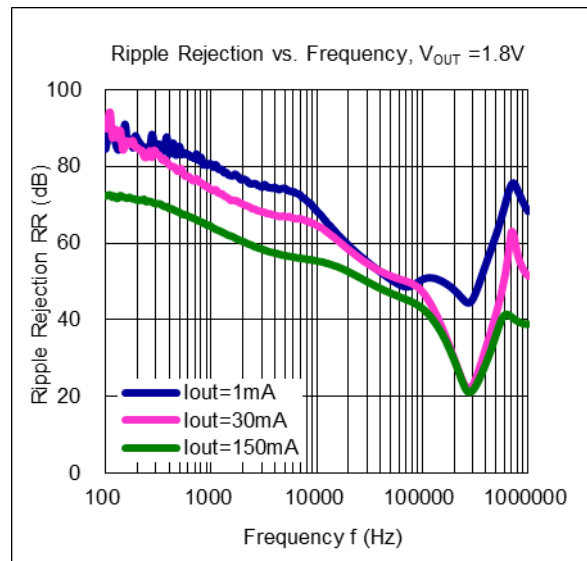
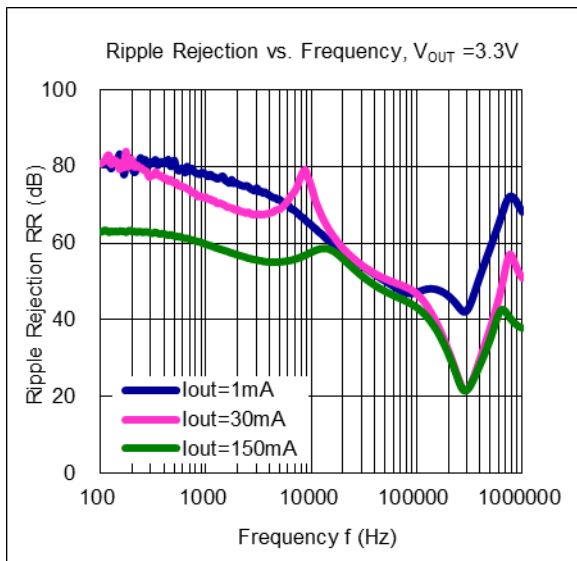
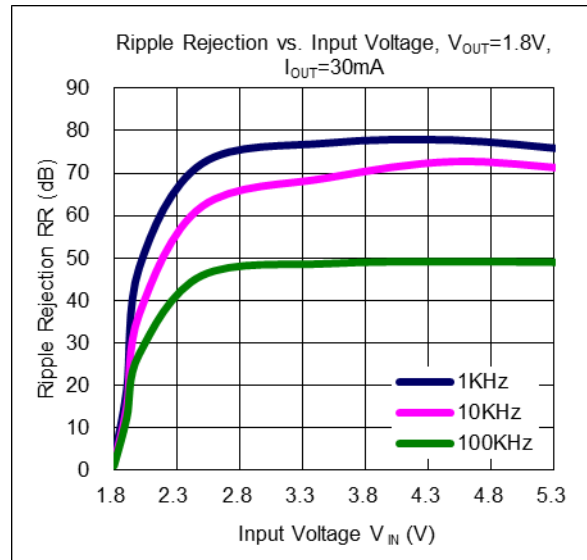
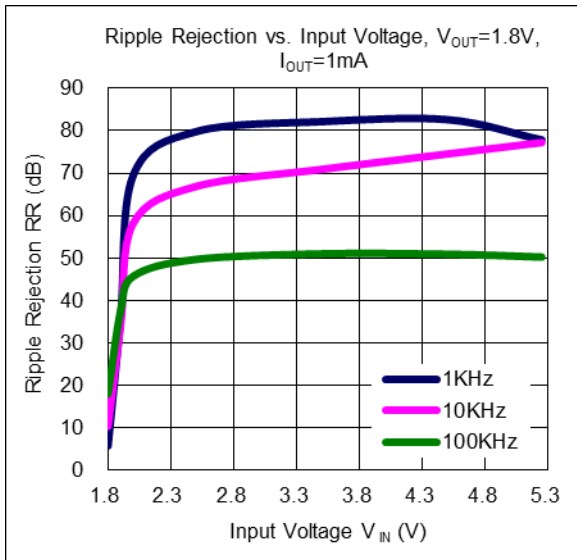
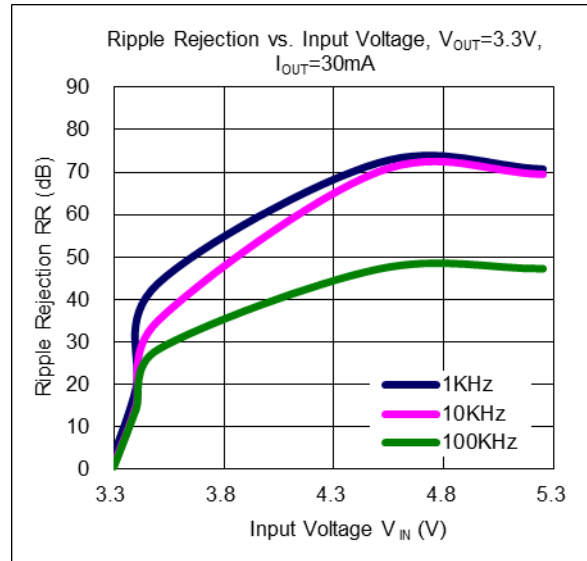
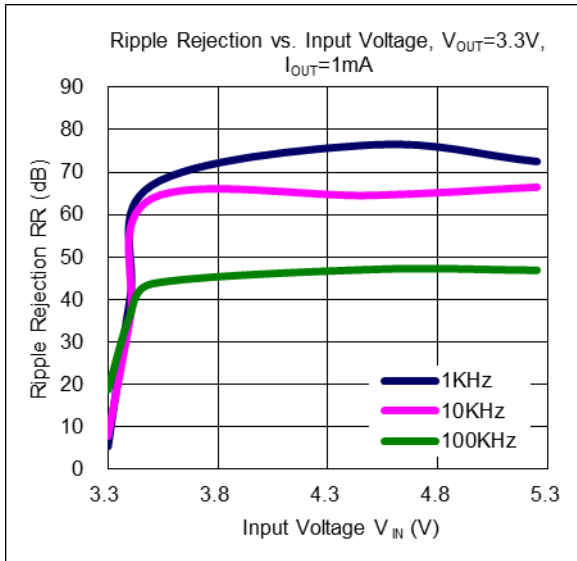

Performance Characteristics (Cont.)

Line Transient Response

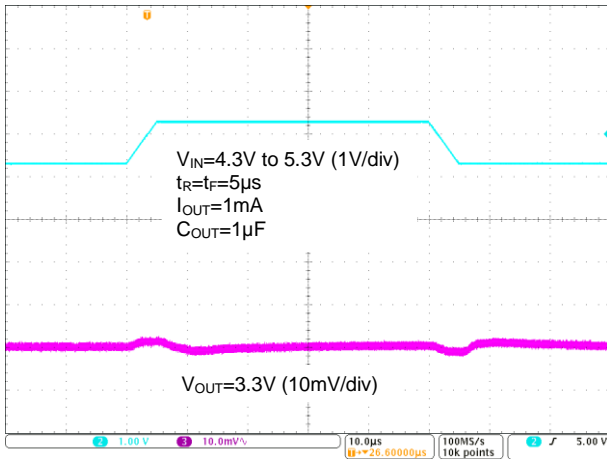

Line Transient Response

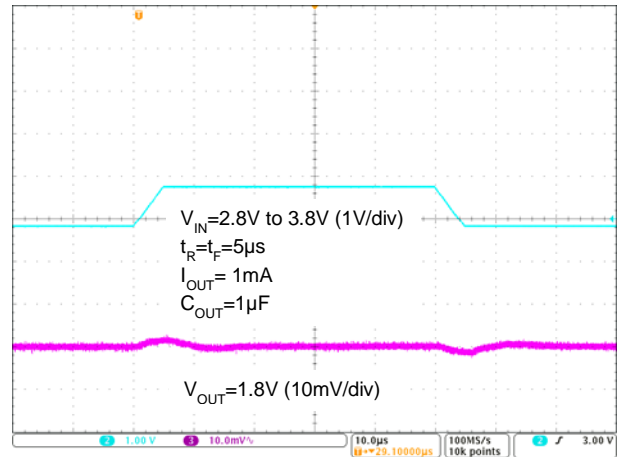

Load Transient Response

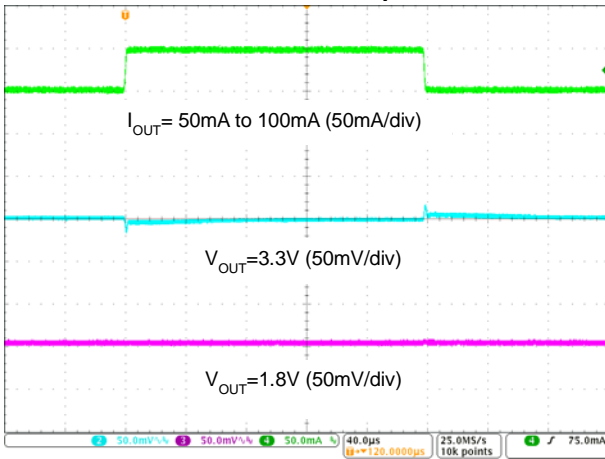

Load Transient Response

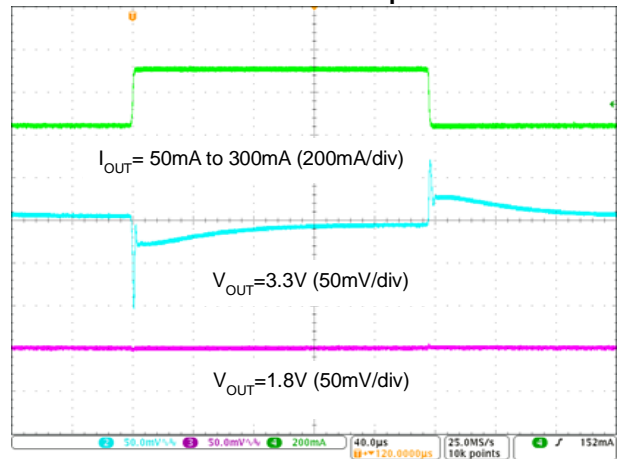

Load Transient Response

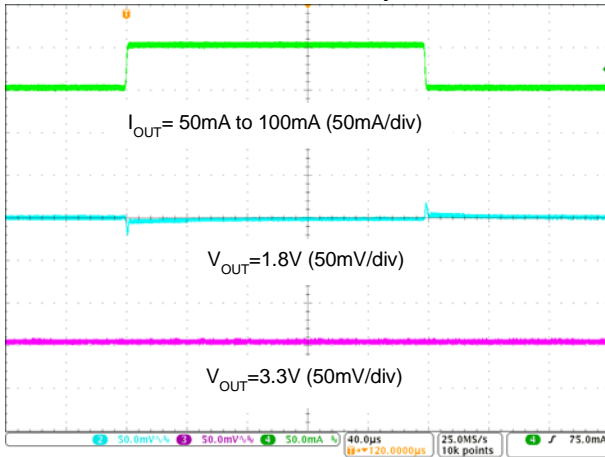

Load Transient Response

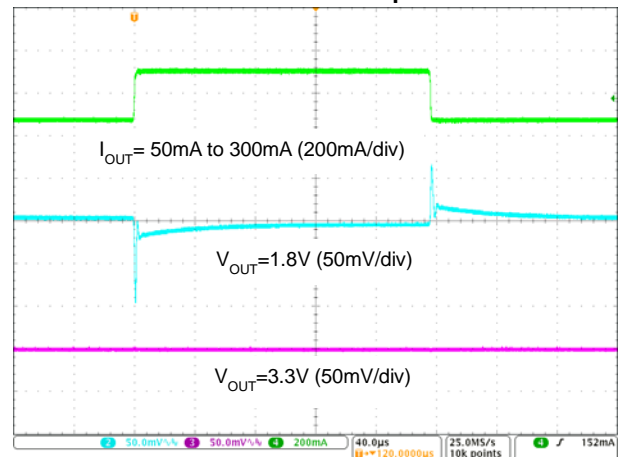

NEW PRODUCT

Performance Characteristics (Cont.)

Turn on Waveform,  $V_{OUT}=3.3V$

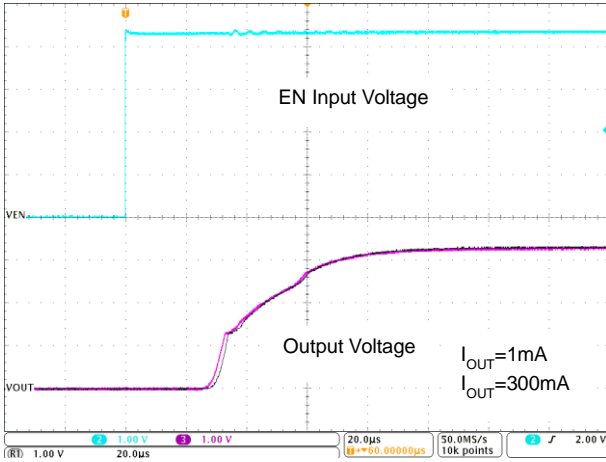

Turn on Waveform,  $V_{OUT}=1.8V$

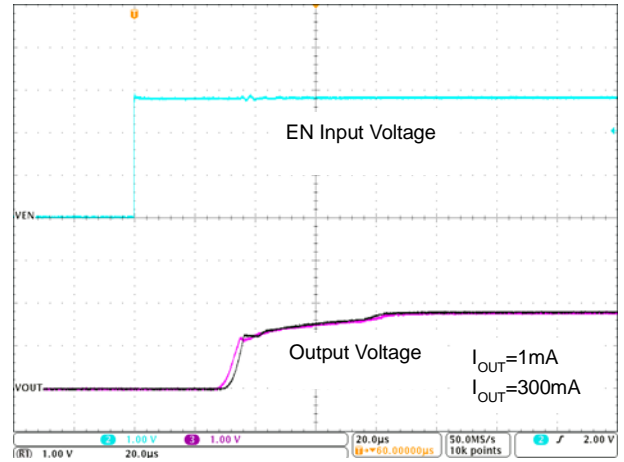

Turn off Waveform,  $V_{OUT}=3.3V$

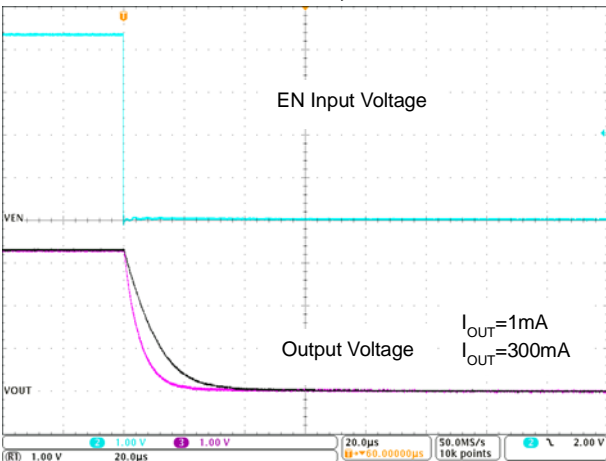

Turn off Waveform,  $V_{OUT}=1.8V$

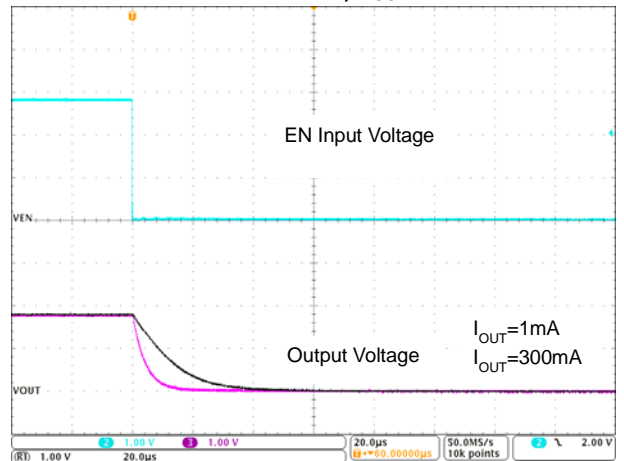

NEW PRODUCT

## Application Information

### Output Capacitor

An output capacitor ( $C_{OUT}$ ) is needed to improve transient response and maintain stability. The AP7345D is stable with very small ceramic output capacitors. The ESR (Equivalent Series Resistance) and capacitance drives the selection. If the application has large load variations, it is recommended to utilize low-ESR bulk capacitors. It is recommended to place ceramic capacitors as close as possible to the load and the GND pins and care should be taken to reduce the impedance in the layout.

### Input Capacitor

To prevent the input voltage from dropping during load steps, it is recommended to utilize an input capacitor ( $C_{IN}$ ). A minimum  $1\mu\text{F}$  ceramic capacitor is recommended between  $V_{IN}$  and GND pins to decouple input power supply glitch. This input capacitor must be located as close as possible to the device to assure input stability and reduce noise. For PCB layout, a wide copper trace is required for both  $V_{IN}$  and GND pins.

### Enable Control

The AP7345D is turned on by setting the EN pins high, and is turned off by pulling it low. If this feature is not used, the EN pins should be tied to  $V_{IN}$  pins to keep the regulator output on at all time. To ensure proper operation, the signal source used to drive the EN pins must be able to swing above and below the specified turn-on/off voltage thresholds listed in the Electrical Characteristics section.

### Short Circuit Protection

When  $V_{OUT}$  pins are short-circuit to GND, short circuit protection will be triggered and clamp the output current to approximately 60mA. This feature protects the regulator from over-current and damage due to overheating.

### Layout Considerations

For good ground loop and stability, the input and output capacitors should be located close to the input, output, and GND pins of the device. The regulator GND pins should be connected to the external circuit ground to reduce voltage drop caused by trace impedance. Ground plane is generally used to reduce trace impedance. Wide trace should be used for large current paths from  $V_{IN}$  to  $V_{OUT}$ , and load circuit.

## ESR vs. Output Current

Ceramic type output capacitor is recommended for this series; however, the other output capacitors with low ESR also can be used. The relations between  $I_{OUT}$  (Output Current) and ESR of an output capacitor are shown below. The stable region is marked as the hatched area in the graph.

Measurement conditions: Frequency Band: 10Hz to 2MHz, Temperature:  $-40^{\circ}\text{C}$  to  $+85^{\circ}\text{C}$ .

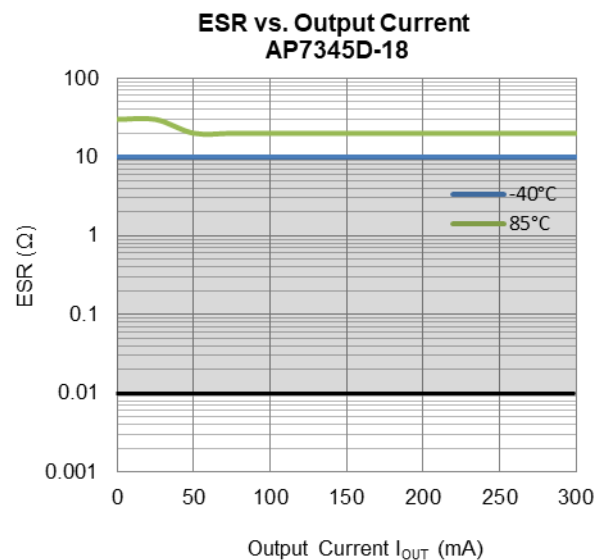
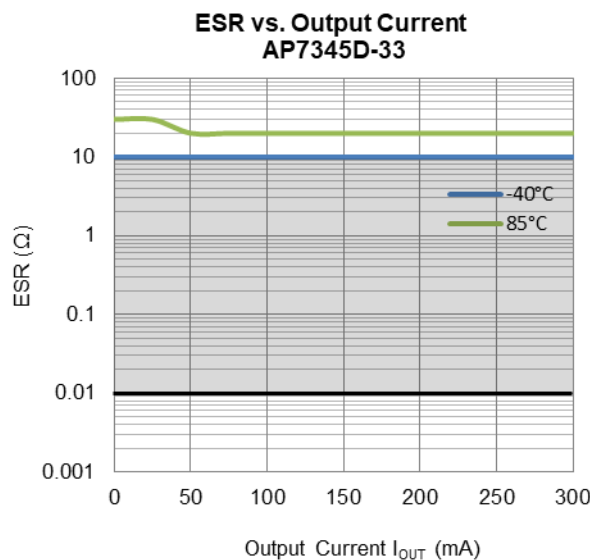

## Ordering Information

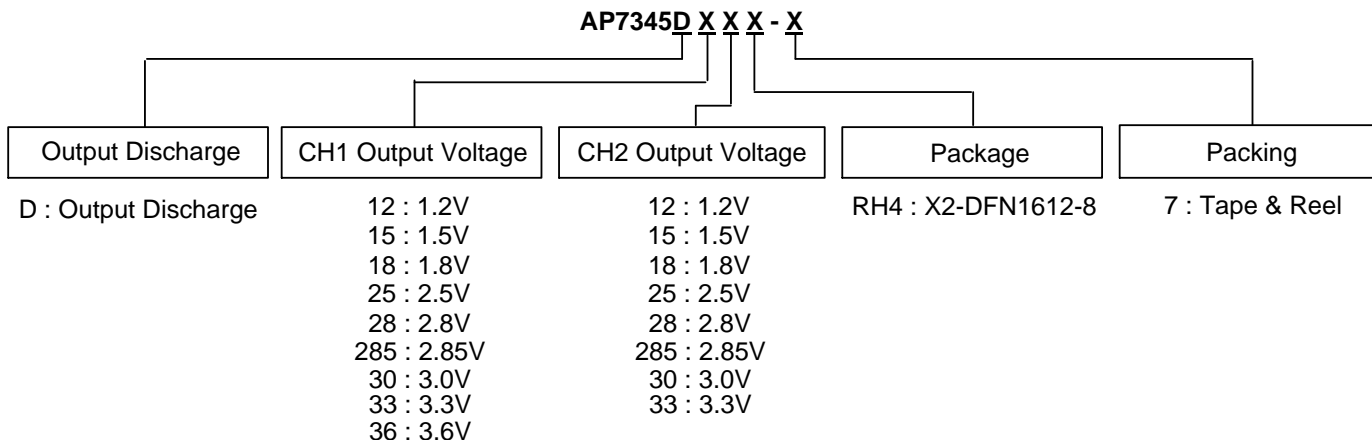

| Part Number           | Package Code | Packaging    | 7" Tape and Reel |                    |
|-----------------------|--------------|--------------|------------------|--------------------|
|                       |              |              | Quantity         | Part Number Suffix |
| AP7345D-XXXX(XX)RH4-7 | RH4          | X2-DFN1612-8 | 5000/Tape & Reel | -7                 |

## Marking Information

(1) X2-DFN1612-8

(Top View)

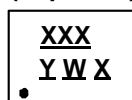

**XXX** : Identification Code  
**Y** : Year : 0~9  
**W** : Week : A~Z : 1~26 week;  
           a~z : 27~52 week; z represents  
           52 and 53 week  
**X** : Internal code

| Part Number       | V <sub>OUT1</sub> /V <sub>OUT2</sub> | Package      | Identification Code |
|-------------------|--------------------------------------|--------------|---------------------|
| AP7345D-1218RH4-7 | 1.2V/1.8V                            | X2-DFN1612-8 | FAA                 |
| AP7345D-1528RH4-7 | 1.5V/2.8V                            | X2-DFN1612-8 | FAB                 |
| AP7345D-1812RH4-7 | 1.8V/1.2V                            | X2-DFN1612-8 | FAC                 |
| AP7345D-1815RH4-7 | 1.8V/1.5V                            | X2-DFN1612-8 | FAD                 |
| AP7345D-1818RH4-7 | 1.8V/1.8V                            | X2-DFN1612-8 | FAE                 |
| AP7345D-1828RH4-7 | 1.8V/2.8V                            | X2-DFN1612-8 | FAF                 |
| AP7345D-1833RH4-7 | 1.8V/3.3V                            | X2-DFN1612-8 | FAG                 |
| AP7345D-2518RH4-7 | 2.5V/1.8V                            | X2-DFN1612-8 | FAH                 |

## Marking Information (Cont.)

| Part Number         | V <sub>OUT1</sub> /V <sub>OUT2</sub> | Package      | Identification Code |
|---------------------|--------------------------------------|--------------|---------------------|
| AP7345D-2812RH4-7   | 2.8V/1.2V                            | X2-DFN1612-8 | FAJ                 |
| AP7345D-2818RH4-7   | 2.8V/1.8V                            | X2-DFN1612-8 | FAK                 |
| AP7345D-2825RH4-7   | 2.8V/2.5V                            | X2-DFN1612-8 | FAM                 |
| AP7345D-2833RH4-7   | 2.8V/3.3V                            | X2-DFN1612-8 | FAN                 |
| AP7345D-2828RH4-7   | 2.8V/2.8V                            | X2-DFN1612-8 | FAP                 |
| AP7345D-285285RH4-7 | 2.85V/2.85V                          | X2-DFN1612-8 | FAR                 |
| AP7345D-3018RH4-7   | 3.0V/1.8V                            | X2-DFN1612-8 | FAS                 |
| AP7345D-3028RH4-7   | 3.0V/2.8V                            | X2-DFN1612-8 | FAT                 |
| AP7345D-3030RH4-7   | 3.0V/3.0V                            | X2-DFN1612-8 | FAU                 |
| AP7345D-3318RH4-7   | 3.3V/1.8V                            | X2-DFN1612-8 | FAV                 |
| AP7345D-3328RH4-7   | 3.3V/2.8V                            | X2-DFN1612-8 | FAW                 |
| AP7345D-3330RH4-7   | 3.3V/3.0V                            | X2-DFN1612-8 | FAX                 |
| AP7345D-3333RH4-7   | 3.3V/3.3V                            | X2-DFN1612-8 | FAY                 |
| AP7345D-3612RH4-7   | 3.6V/1.2V                            | X2-DFN1612-8 | FAZ                 |

NEW PRODUCT

**Package Outline Dimensions**

Please see <http://www.diodes.com/package-outlines.html> for the latest version.

X2-DFN1612-8

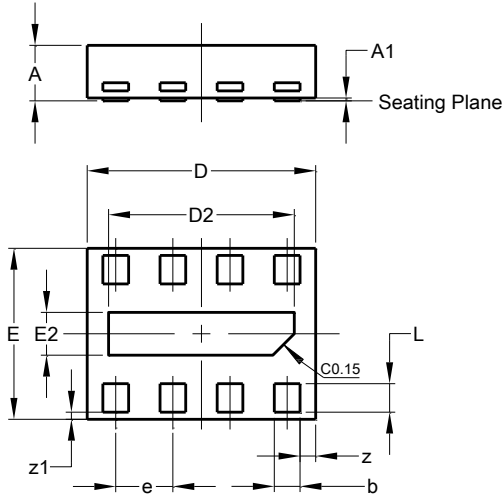

| X2-DFN1612-8         |      |      |      |
|----------------------|------|------|------|
| Dim                  | Min  | Max  | Typ  |
| A                    | —    | 0.40 | 0.39 |
| A1                   | 0.00 | 0.05 | 0.02 |
| b                    | 0.13 | 0.23 | 0.18 |
| D                    | 1.55 | 1.65 | 1.60 |
| D2                   | 1.25 | 1.35 | 1.30 |
| E                    | 1.15 | 1.25 | 1.20 |
| E2                   | 0.25 | 0.35 | 0.30 |
| e                    | —    | —    | 0.40 |
| L                    | 0.15 | 0.25 | 0.20 |
| z                    | —    | —    | 0.11 |
| z1                   | —    | —    | 0.05 |
| All Dimensions in mm |      |      |      |

**Suggested Pad Layout**

Please see <http://www.diodes.com/package-outlines.html> for the latest version.

X2-DFN1612-8

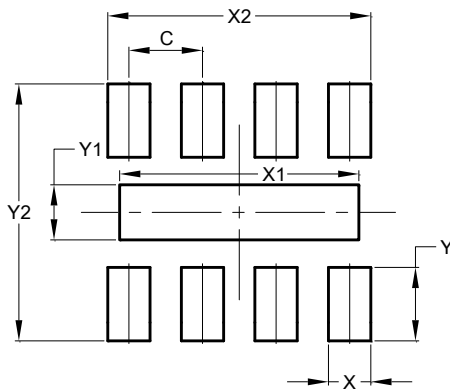

| Dimensions | Value (in mm) |
|------------|---------------|
| C          | 0.400         |
| X          | 0.230         |
| X1         | 1.300         |
| X2         | 1.430         |
| Y          | 0.400         |
| Y1         | 0.300         |
| Y2         | 1.400         |

NEW PRODUCT

## Tape Orientation

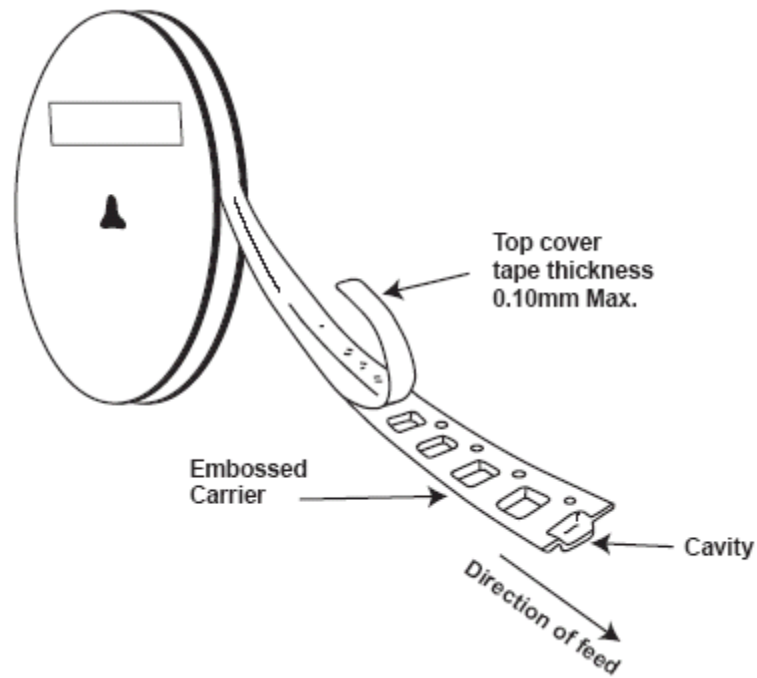
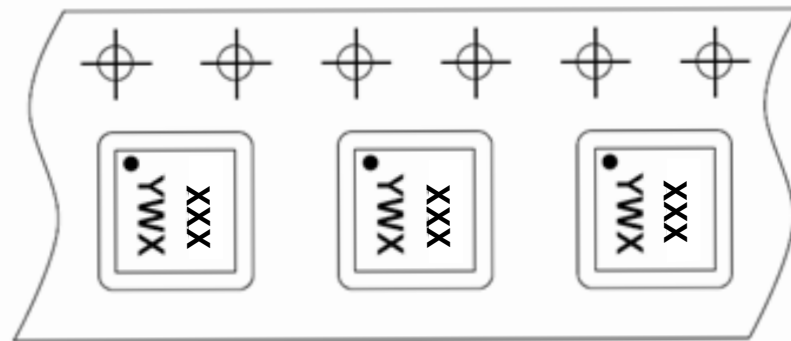

Note: The taping orientation of the other package type can be found on our website at <http://www.diodes.com/datasheets/ap02007.pdf>.

**IMPORTANT NOTICE**

DIODES INCORPORATED MAKES NO WARRANTY OF ANY KIND, EXPRESS OR IMPLIED, WITH REGARDS TO THIS DOCUMENT, INCLUDING, BUT NOT LIMITED TO, THE IMPLIED WARRANTIES OF MERCHANTABILITY AND FITNESS FOR A PARTICULAR PURPOSE (AND THEIR EQUIVALENTS UNDER THE LAWS OF ANY JURISDICTION).

Diodes Incorporated and its subsidiaries reserve the right to make modifications, enhancements, improvements, corrections or other changes without further notice to this document and any product described herein. Diodes Incorporated does not assume any liability arising out of the application or use of this document or any product described herein; neither does Diodes Incorporated convey any license under its patent or trademark rights, nor the rights of others. Any Customer or user of this document or products described herein in such applications shall assume all risks of such use and will agree to hold Diodes Incorporated and all the companies whose products are represented on Diodes Incorporated website, harmless against all damages.

Diodes Incorporated does not warrant or accept any liability whatsoever in respect of any products purchased through unauthorized sales channel. Should Customers purchase or use Diodes Incorporated products for any unintended or unauthorized application, Customers shall indemnify and hold Diodes Incorporated and its representatives harmless against all claims, damages, expenses, and attorney fees arising out of, directly or indirectly, any claim of personal injury or death associated with such unintended or unauthorized application.

Products described herein may be covered by one or more United States, international or foreign patents pending. Product names and markings noted herein may also be covered by one or more United States, international or foreign trademarks.

This document is written in English but may be translated into multiple languages for reference. Only the English version of this document is the final and determinative format released by Diodes Incorporated.

**LIFE SUPPORT**

Diodes Incorporated products are specifically not authorized for use as critical components in life support devices or systems without the express written approval of the Chief Executive Officer of Diodes Incorporated. As used herein:

A. Life support devices or systems are devices or systems which:

1. are intended to implant into the body, or
2. support or sustain life and whose failure to perform when properly used in accordance with instructions for use provided in the labeling can be reasonably expected to result in significant injury to the user.

B. A critical component is any component in a life support device or system whose failure to perform can be reasonably expected to cause the failure of the life support device or to affect its safety or effectiveness.

Customers represent that they have all necessary expertise in the safety and regulatory ramifications of their life support devices or systems, and acknowledge and agree that they are solely responsible for all legal, regulatory and safety-related requirements concerning their products and any use of Diodes Incorporated products in such safety-critical, life support devices or systems, notwithstanding any devices- or systems-related information or support that may be provided by Diodes Incorporated. Further, Customers must fully indemnify Diodes Incorporated and its representatives against any damages arising out of the use of Diodes Incorporated products in such safety-critical, life support devices or systems.

Copyright © 2018, Diodes Incorporated

[www.diodes.com](http://www.diodes.com)

## Looking for pricing, stock, or lifecycle information?

Click below to explore more details on WIN SOURCE:

- ⊖ [View AP7345D-2833RH4-7 on WIN SOURCE](#)
- ⊖ [Diodes Incorporated Information](#)

## Optimize Your Supply Chain with WIN SOURCE Solutions

- ✓ Global Sourcing Solution
- ✓ Obsolete Management
- ✓ Cost Control Management
- ✓ Shortage Management
- ✓ Alternative Solution
- ✓ Excess Inventory Management