



**THE DATASHEET OF
AP22916BCA4-7**



Description

The AP22916 is a small, low leakage, single P-channel power MOSFET designed for low-power consumption and load-switching applications. This power MOSFET has a typical $R_{DS(ON)}$ of 60mΩ at 5V, allowing increased load current handling capacity with a low forward voltage drop. Multiple voltages correspond to different time options to support various system load conditions. The trigger of the load switch ON pin can be controlled to be enabled or disabled by an external low voltage digital signal for sequence control application. The smart, pull down feature is built into the ON pin. Once the enable voltage is higher than V_{IH} , it will disconnect to avoid power loss. V_{IN} and V_{OUT} are isolated during OFF state with the TRCB (true reverse current blocking) feature.

The AP22916 load switch is designed to operate from 1.3V to 5.5V, making it ideal for 1.3V, 1.8V, 2.5V, 3.6V, and 5V systems. The typical quiescent supply current is only 0.5μA.

The AP22916 is available in the wafer-level chip-scale 4-pin, U-WLB0808-4 (Type B) 0.78mm x 0.78mm x 0.455mm, 0.4mm pitch package. The device is characterized for operation over a temperature range of -40°C to +85°C.

Features

- Wide Input Voltage Range: 1.3V to 5.5V
- Low On-Resistance
 - 280mΩ Typical @1.3V
 - 135mΩ Typical @1.8V
 - 65mΩ Typical @3.6V
 - 54mΩ Typical @5.0V
- Continuous Current Capability up to 2A
- True Reverse Current Blocking (TRCB)
- Discharging Resistor on V_{OUT} When Disabled
- Ultra-Low Quiescent Current 0.5μA
- Active-High Control Pin
 - Minimum 1.0V V_{IH} of ON
- ESD Protection:
 - Human Body Model: 2kV
 - Charged Device Model: 1kV
- Package:
 - U-WLB0808-4 (Type B) with Backside Laminate
 - 0.78mm x 0.78mm, 0.4mm Ball Pitch
- **Totally Lead-Free & Fully RoHS Compliant (Notes 1 & 2)**
- **Halogen and Antimony Free. "Green" Device (Note 3)**
- **For automotive applications requiring specific change control (i.e. parts qualified to AEC-Q100/101/104/200, PPAP capable, and manufactured in IATF 16949 certified facilities), please [contact us](#) or your local Diodes representative. <https://www.diodes.com/quality/product-definitions/>**

Notes: 1. No purposely added lead. Fully EU Directive 2002/95/EC (RoHS), 2011/65/EU (RoHS 2) & 2015/863/EU (RoHS 3) compliant.
 2. See <https://www.diodes.com/quality/lead-free/> for more information about Diodes Incorporated's definitions of Halogen- and Antimony-free, "Green" and Lead-free.
 3. Halogen- and Antimony-free "Green" products are defined as those which contain <900ppm bromine, <900ppm chlorine (<1500ppm total Br + Cl) and <1000ppm antimony compounds.

Pin Assignments

U-WLB0808-4 (Type B)

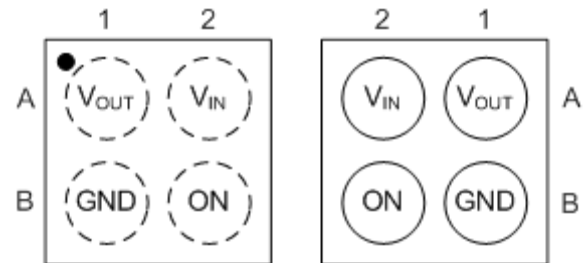

Top View

Bottom View

Applications

- Mobile devices and smart phones
- Portable media devices
- Wearable devices
- Advanced notebooks, UMPC, and MID
- Portable medical devices
- GPS and navigation equipment

Part Comparison Table

Version	Timing	Output Discharge	Enable
AP22916B	Fast	Yes	Active High
AP22916C	Slow	Yes	Active High
AP22916D	Fast	No	Active High
AP22916E	Slow	No	Active High

Typical Applications Circuit

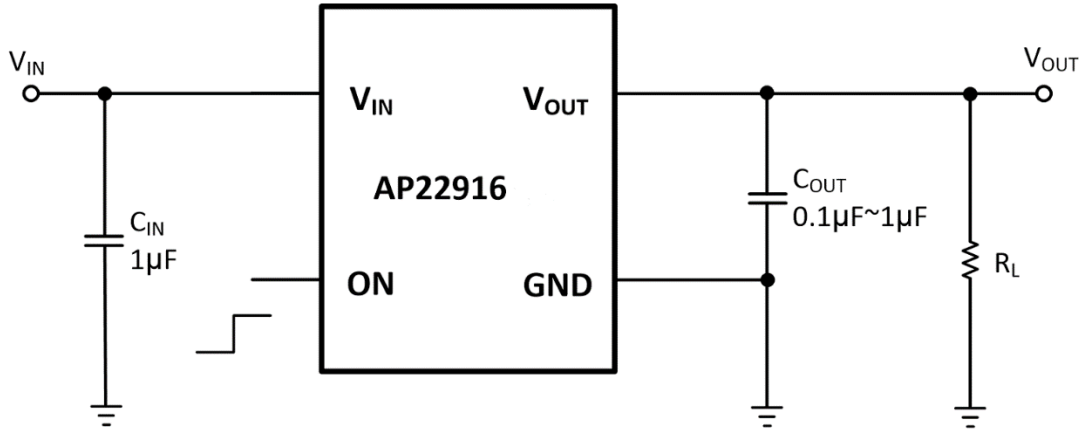

Pin Descriptions

Pin Name	Pin Number	Function
V _{OUT}	A1	Voltage output pin. This is the pin to the P-channel MOSFET drain connection. Bypass to ground through a 0.1µF or 1µF capacitor.
V _{IN}	A2	Voltage input pin. This is the pin to the P-channel MOSFET source. Bypass to ground through a 1µF capacitor.
GND	B1	Ground
ON	B2	Enable input

Functional Block Diagram

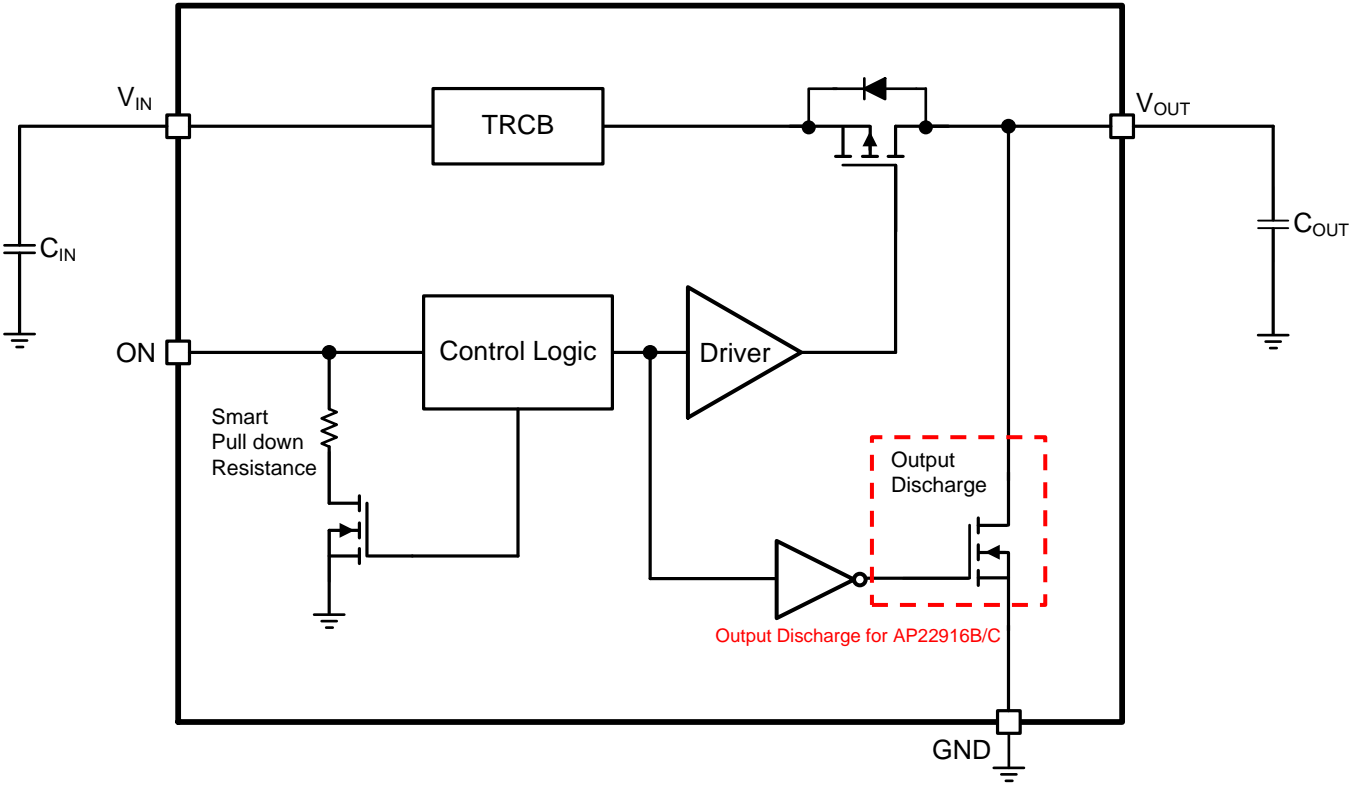

Absolute Maximum Ratings (@ $T_A = +25^\circ\text{C}$, unless otherwise specified.)

Symbol	Parameter	Ratings	Unit
ESD HBM	Human Body Model ESD Protection	2	kV
ESD CDM	Charged Device Model ESD Protection	1	kV
V_{IN}	Input Voltage	-0.3 to 6	V
V_{OUT}	Output Voltage	-0.3 to 6	V
V_{ON}	ON Voltage	-0.3 to 6	V
I_{LOAD}	Maximum Continuous Load Current	2	A
I_{LOAD}	Maximum Pulse Load Current, Pulse <300 μs , 2% Duty Cycle	2.5	A
T_J	Maximum Junction Temperature	+125	$^\circ\text{C}$
T_{ST}	Storage Temperature Range	-65 to +150	$^\circ\text{C}$
P_D	Power Dissipation	510	mW
$R_{\theta JA}$	Thermal Resistance, Junction to Ambient (Note 4)	195	$^\circ\text{C}/\text{W}$
$R_{\theta JC}$	Thermal Resistance, Junction to Case (Note 5)	38	$^\circ\text{C}/\text{W}$
T_{LEAD}	Maximum Lead temperature (10-s soldering time)	260	$^\circ\text{C}$

Notes: 4. The JEDEC high-K (2s2p) board used to derive this data was a 3 inch x 3 inch, multilayer board with 1oz internal power and ground planes with 2oz copper traces on top and bottom of the board.
5. Thermal resistance from junction to case.

Caution: Stresses greater than the 'Absolute Maximum Ratings' specified above, may cause permanent damage to the device. These are stress ratings only; functional operation of the device at these or any other conditions exceeding those indicated in this specification is not implied. Device reliability may be affected by exposure to absolute maximum rating conditions for extended periods of time.

Recommended Operating Conditions (@ $T_A = +25^\circ\text{C}$, unless otherwise specified.)

Symbol	Parameter	Min	Max	Unit
V_{IN}	Input Voltage	1.3	5.5	V
V_{ON}	ON Voltage Range	0	5.5	V
V_{OUT}	Output Voltage	1.3	5.5	V
I_{OUT}	Output Current while $V_{in} \geq 1.5\text{V}$	0	2.0	A
	Output Current while $V_{in} \leq 1.5\text{V}$	0	1.0	A
V_{IH}	ON High-Level Input Voltage	1.0	5.5	V
V_{IL}	ON Low-Level Input Voltage	0	0.35	V
T_A	Operating Ambient Temperature	-40	+85	$^\circ\text{C}$

Electrical Characteristics ($T_A = -40^\circ\text{C}$ to $+85^\circ\text{C}$, $V_{IN} = 1.3$ to 5.5V , $V_{ON} = V_{IN}$ (Enabled), $V_{ON} = 0\text{V}$ (Disabled), $C_{IN} = 1\mu\text{F}$, $C_{OUT} = 0.1\mu\text{F}$, unless otherwise specified. Typical values are at 25°C) (Note 6)

Symbol	Parameters	Test Conditions	Min	Typ	Max	Unit	
I_Q	Input Quiescent Current	$I_{OUT} = 0\text{mA}$, V_{ON} Enabled	—	0.3	0.5	μA	
I_{SHDN}	Input Shutdown Current	$R_L = 1\text{M}\Omega$, V_{ON} Disabled, $V_{IN} = 5.0\text{V}$	$+25^\circ\text{C}$	—	40	—	nA
			-40°C to $+85^\circ\text{C}$	—	—	225	
		$R_L = 1\text{M}\Omega$, V_{ON} Disabled, $V_{IN} = 1.8\text{V}$	$+25^\circ\text{C}$	—	5	—	
			-40°C to $+85^\circ\text{C}$	—	—	20	
$R_{DS(ON)}$	Switch On-resistance, $I_{OUT} = 200\text{mA}$	$V_{IN} = 5.0\text{V}$	$+25^\circ\text{C}$	—	54	60	m Ω
			-40°C to $+85^\circ\text{C}$	—	—	70	
			-40°C to $+105^\circ\text{C}$	—	—	75	
		$V_{IN} = 3.6\text{V}$	$+25^\circ\text{C}$	—	65	75	
			-40°C to $+85^\circ\text{C}$	—	—	85	
			-40°C to $+105^\circ\text{C}$	—	—	90	
		$V_{IN} = 1.8\text{V}$	$+25^\circ\text{C}$	—	135	150	
			-40°C to $+85^\circ\text{C}$	—	—	165	
			-40°C to $+105^\circ\text{C}$	—	—	180	
		$V_{IN} = 1.3\text{V}$	$+25^\circ\text{C}$	—	280	310	
			-40°C to $+85^\circ\text{C}$	—	—	320	
			-40°C to $+105^\circ\text{C}$	—	—	350	
R_{ON}	Smart Pull Down Resistance	V_{ON} Disabled	—	750	—	k Ω	
V_{RCB}	TRCB Trigger Voltage	V_{ON} Enabled, $V_{OUT} > V_{IN}$	—	25	—	mV	
I_{RCB}	TRCB Activation Current	$V_{IN} = 3.3\text{V}$, V_{ON} Enabled, $V_{OUT} > V_{IN}$	—	-650	—	mA	
t_{RCB}	TRCB Response Time	V_{ON} Enabled, $V_{OUT} > V_{IN} + 200\text{mV}$	—	10	—	μs	
I_{IN_RCB}	TRCB Reverse Leakage Current (Current from V_{IN})	V_{ON} Enabled, $V_{OUT} - V_{IN} > V_{RCB}$	-300	—	—	nA	
R_{DIS}	Output Discharge On Resistance	V_{ON} Disabled, $I_{OUT} = 1\text{mA}$	—	150	—	Ω	

Note: 6. Specifications are over -40°C to $+85^\circ\text{C}$ and are guaranteed by characterization and design.

Timing Characteristics (The typical characteristics in the following table applies over the entire recommended power supply voltage range of 1.3V to 5.5V at 25°C with a load of $C_{OUT} = 0.1\mu F$, $R_L = 10\Omega$, unless otherwise specified.) (Note 7)

Symbol	Parameters	Test Conditions	Min	Typ	Max	Unit
AP22916B						
t_{ON}	Output Turn-on	$V_{IN} = 5.0V$	—	85	—	μs
		$V_{IN} = 3.6V$	—	110	—	
		$V_{IN} = 1.8V$	—	250	—	
		$V_{IN} = 1.3V$	—	480	—	
t_R	Output Rise Time	$V_{IN} = 5.0V$	—	42	—	μs
		$V_{IN} = 3.6V$	—	52	—	
		$V_{IN} = 1.8V$	—	95	—	
		$V_{IN} = 1.3V$	—	180	—	
SR_{ON}	Slew Rate	$V_{IN} = 5.0V$	—	90	—	$mV/\mu s$
		$V_{IN} = 3.6V$	—	52	—	
		$V_{IN} = 1.8V$	—	13	—	
		$V_{IN} = 1.3V$	—	5	—	
t_{OFF}	Output Turn-off Time	$V_{IN} = 5.0V$	—	6.4	—	μs
		$V_{IN} = 3.6V$	—	8	—	
		$V_{IN} = 1.8V$	—	16	—	
		$V_{IN} = 1.3V$	—	25	—	
t_F	Output Fall Time	$C_{OUT} = 0.1\mu F$, $R_L = 10\Omega$	—	2.3	—	μs
		$C_{OUT} = 1\mu F$, $R_L = Open$	—	357	—	

Note: 7. Rise and fall times of the control signal are less than 100ns.

Symbol	Parameters	Test Conditions	Min	Typ	Max	Unit
AP22916C						
t_{ON}	Output Turn-on	$V_{IN} = 5.0V$	—	1400	—	μs
		$V_{IN} = 3.6V$	—	1700	—	
		$V_{IN} = 1.8V$	—	3800	—	
		$V_{IN} = 1.3V$	—	6800	—	
t_R	Output Rise Time	$V_{IN} = 5.0V$	—	750	—	μs
		$V_{IN} = 3.6V$	—	900	—	
		$V_{IN} = 1.8V$	—	1500	—	
		$V_{IN} = 1.3V$	—	2800	—	
SR_{ON}	Slew Rate	$V_{IN} = 5.0V$	—	5	—	$mV/\mu s$
		$V_{IN} = 3.6V$	—	3.2	—	
		$V_{IN} = 1.8V$	—	1	—	
		$V_{IN} = 1.3V$	—	0.4	—	
t_{OFF}	Output Turn-off Time	$V_{IN} = 5.0V$	—	7.1	—	μs
		$V_{IN} = 3.6V$	—	8	—	
		$V_{IN} = 1.8V$	—	16	—	
		$V_{IN} = 1.3V$	—	25	—	
t_F	Output Fall Time	$C_{OUT} = 0.1\mu F$, $R_L = 10\Omega$	—	2.3	—	μs
		$C_{OUT} = 10\mu F$, $R_L = Open$	—	4490	—	

Note: 7. Rise and fall times of the control signal are less than 100ns.

Timing Characteristics (The typical characteristics in the following table applies over the entire recommended power supply voltage range of 1.3V to 5.5V at 25°C with a load of $C_{OUT} = 0.1\mu F$, $R_L = 10\Omega$, unless otherwise specified.) (Note 7) (continued)

Symbol	Parameters	Test Conditions	Min	Typ	Max	Unit
AP22916D						
t_{ON}	Output Turn-on	$V_{IN} = 5.0V$		85		μs
		$V_{IN} = 3.6V$		110		
		$V_{IN} = 1.8V$		250		
		$V_{IN} = 1.3V$		480		
t_R	Output Rise Time	$V_{IN} = 5.0V$		50		μs
		$V_{IN} = 3.6V$		60		
		$V_{IN} = 1.8V$		110		
		$V_{IN} = 1.3V$		210		
SR_{ON}	Slew Rate	$V_{IN} = 5.0V$		90		mV/ μs
		$V_{IN} = 3.6V$		55		
		$V_{IN} = 1.8V$		15		
		$V_{IN} = 1.3V$		5		
t_{OFF}	Output Turn-off Time	$V_{IN} = 5.0V$		9		μs
		$V_{IN} = 3.6V$		12		
		$V_{IN} = 1.8V$		18		
		$V_{IN} = 1.3V$		35		
t_F	Output Fall Time	$C_{OUT} = 0.1\mu F$, $R_L = 10\Omega$		13		μs

Note: 7. Rise and fall times of the control signal are less than 100ns.

Symbol	Parameters	Test Conditions	Min	Typ	Max	Unit
AP22916E						
t_{ON}	Output Turn-on	$V_{IN} = 5.0V$		1300		μs
		$V_{IN} = 3.6V$		1700		
		$V_{IN} = 1.8V$		3950		
		$V_{IN} = 1.3V$		7200		
t_R	Output Rise Time	$V_{IN} = 5.0V$		750		μs
		$V_{IN} = 3.6V$		930		
		$V_{IN} = 1.8V$		1750		
		$V_{IN} = 1.3V$		3300		
SR_{ON}	Slew Rate	$V_{IN} = 5.0V$		5		mV/ μs
		$V_{IN} = 3.6V$		3		
		$V_{IN} = 1.8V$		0.8		
		$V_{IN} = 1.3V$		0.3		
t_{OFF}	Output Turn-off Time	$V_{IN} = 5.0V$		8		μs
		$V_{IN} = 3.6V$		10		
		$V_{IN} = 1.8V$		15		
		$V_{IN} = 1.3V$		35		
t_F	Output Fall Time	$C_{OUT} = 0.1\mu F$, $R_L = 10\Omega$		13		μs

Note: 7. Rise and fall times of the control signal are less than 100ns.

Timing Characteristics (The typical characteristics in the following table applies over the entire recommended power supply voltage range of 1.3V to 5.5V at 25°C with a load of $C_{OUT} = 0.1\mu F$, $R_L = 10\Omega$, unless otherwise specified.) (Note 7) (continued)

Timing for Power-Up and Power-Down Operation

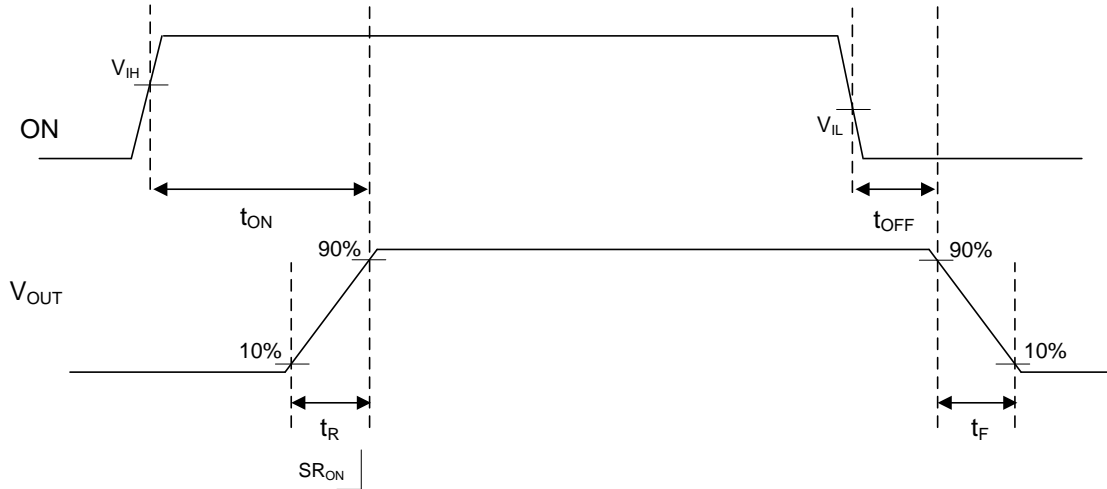

Output Rise (t_R), Fall (t_F), Turn On (t_{ON}) and Turn Off (t_{OFF}) Time

Note: 7. Rise and fall times of the control signal are less than 100ns.

Typical Performance Characteristics ($C_{IN} = 1\mu F$, $C_{OUT} = 0.1\mu F$. All devices in this section are for 25°C, unless otherwise specified.)

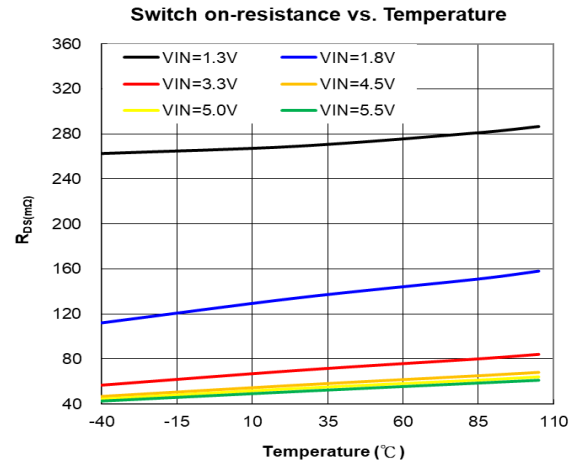
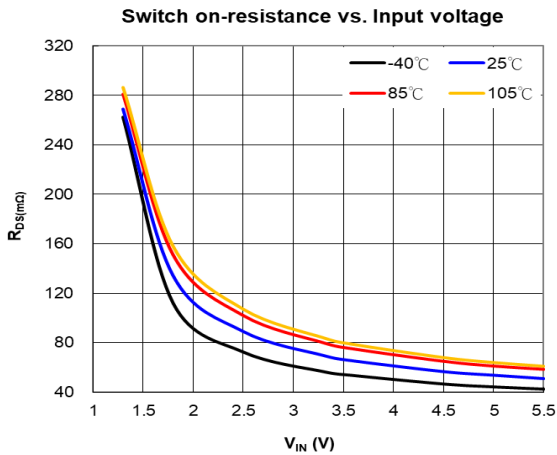
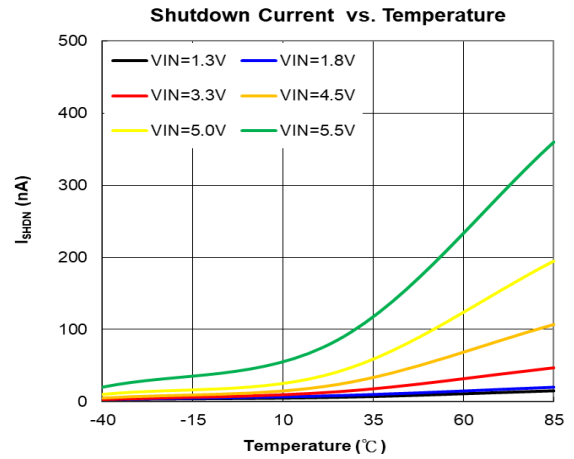
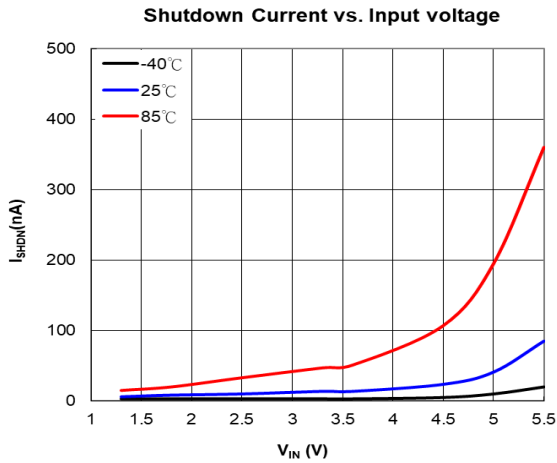
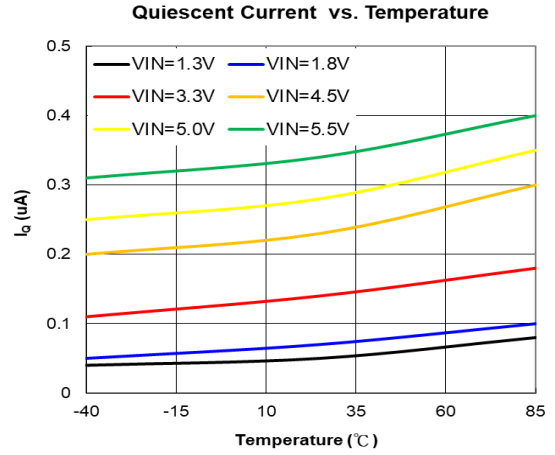
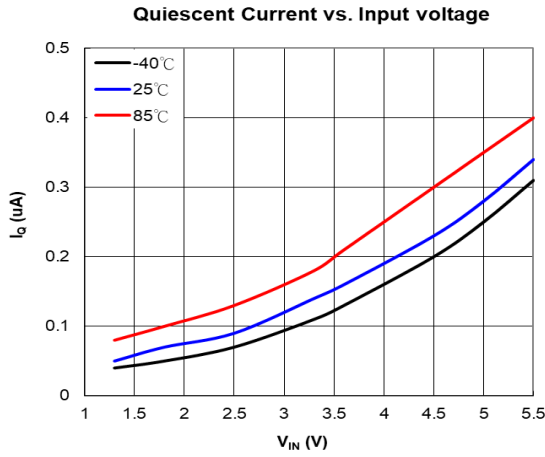

Typical Performance Characteristics ($C_{IN} = 1\mu F$, $C_{OUT} = 0.1\mu F$. All devices in this section are for 25°C, unless otherwise specified.) (continued)

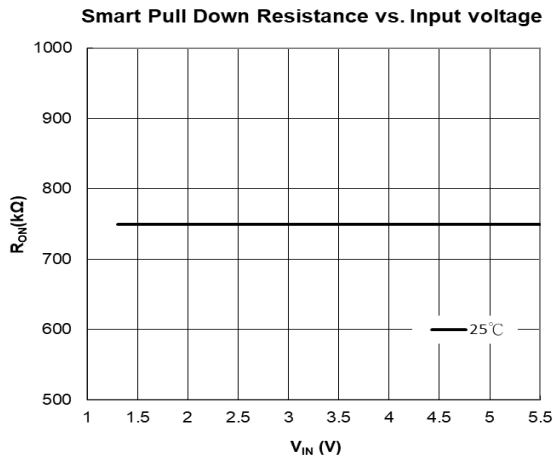
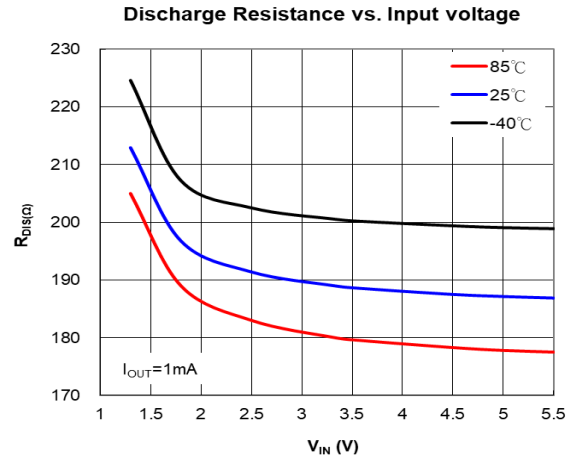
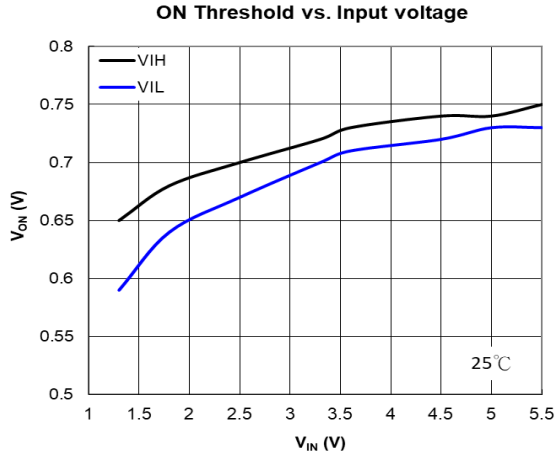

Typical Performance Characteristics ($C_{IN} = 1\mu F$, $C_{OUT} = 0.1\mu F$. All devices in this section are for 25°C, unless otherwise specified.) (continued)

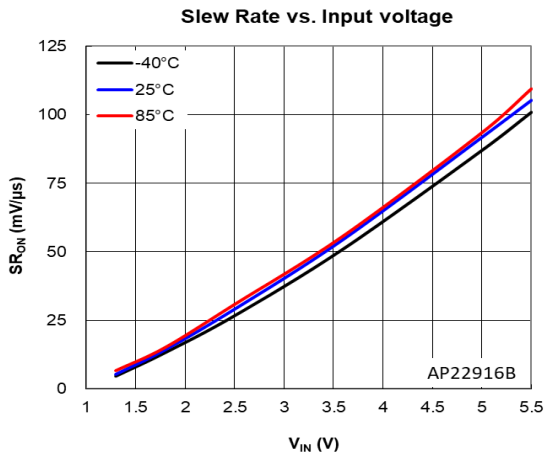
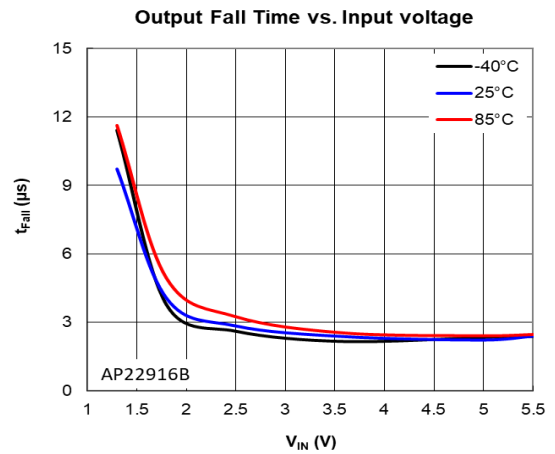
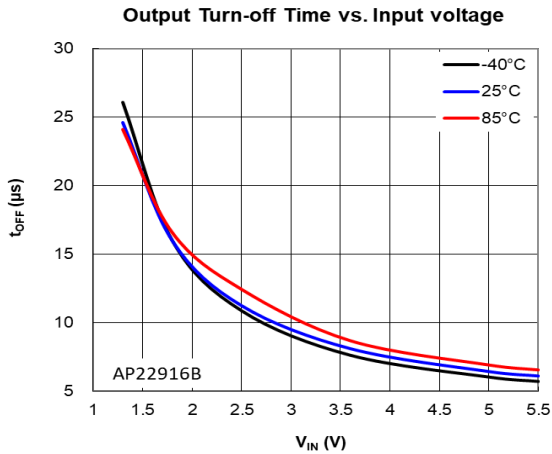
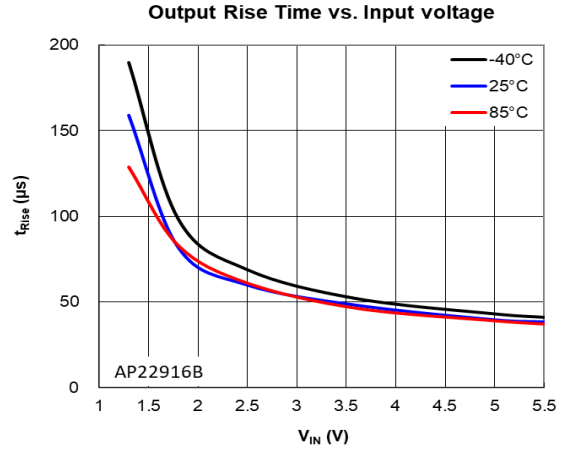
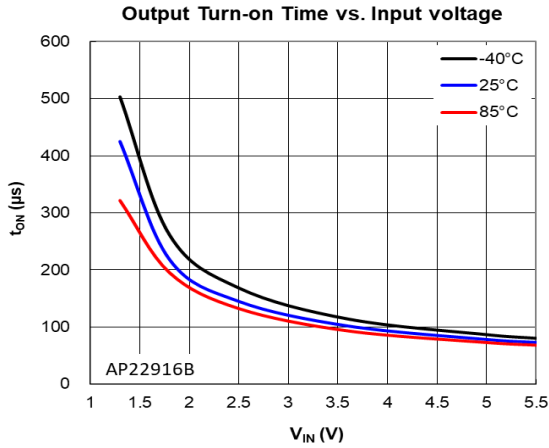

Typical Performance Characteristics ($C_{IN} = 1\mu F$, $C_{OUT} = 0.1\mu F$. All devices in this section are for 25°C, unless otherwise specified.) (continued)

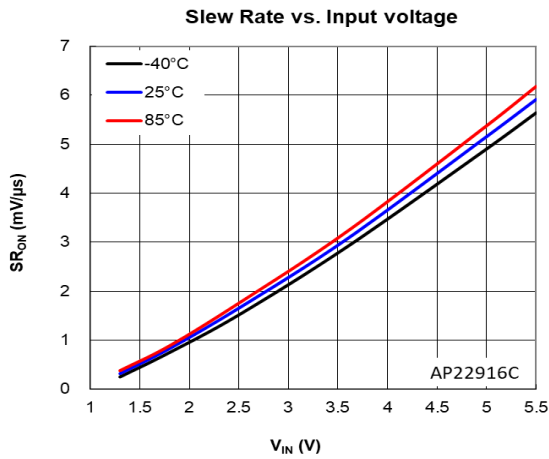
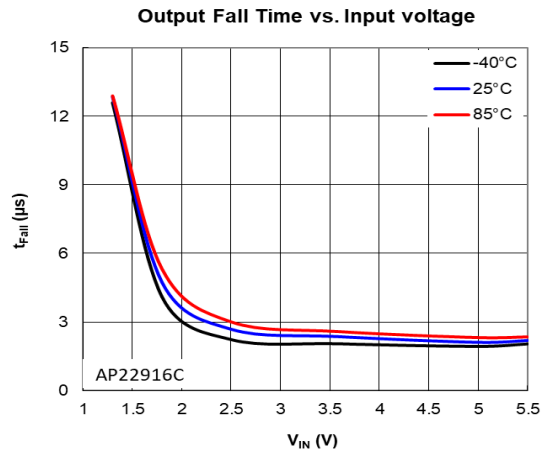
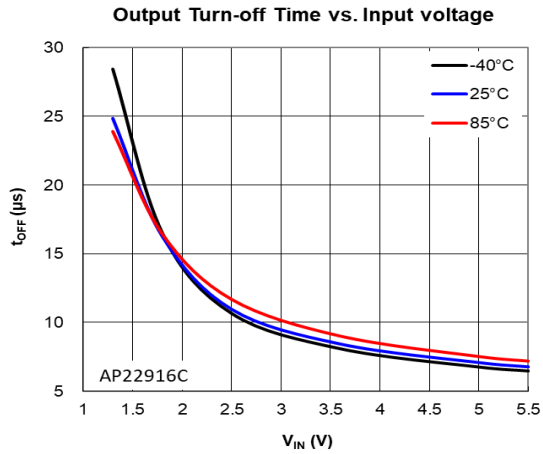
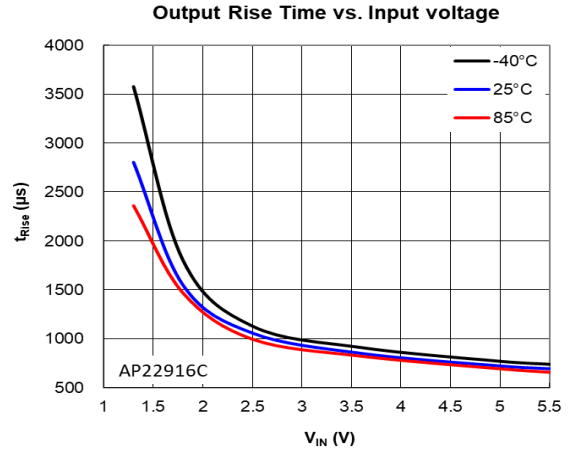
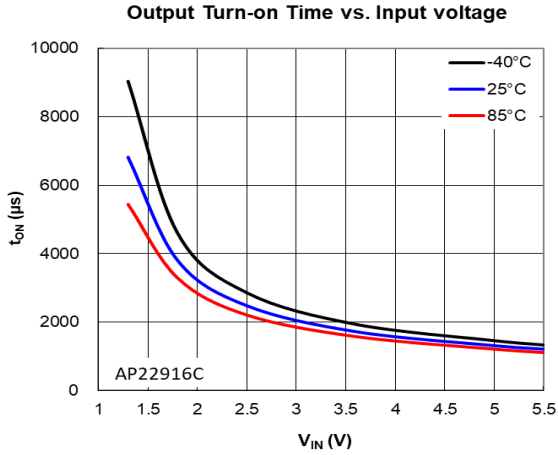

Typical Performance Characteristics ($C_{IN} = 1\mu F$, $C_{OUT} = 0.1\mu F$. All devices in this section are for 25°C, unless otherwise specified.) (continued)

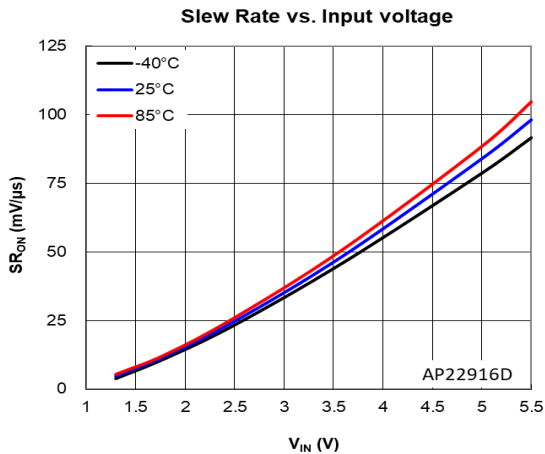
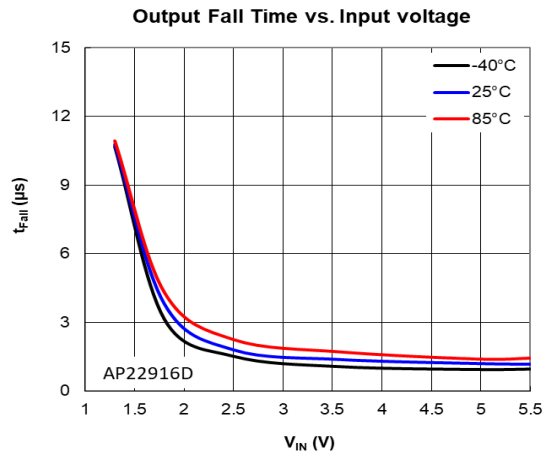
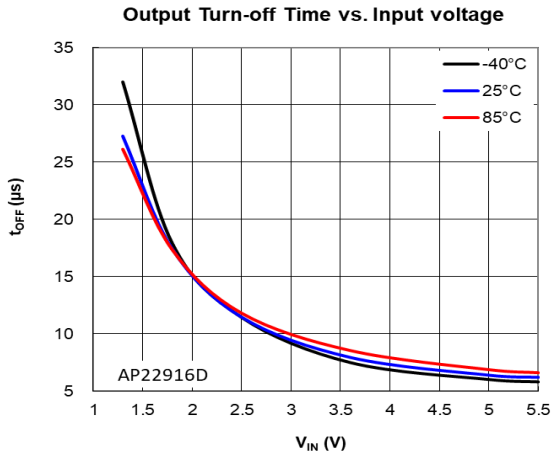
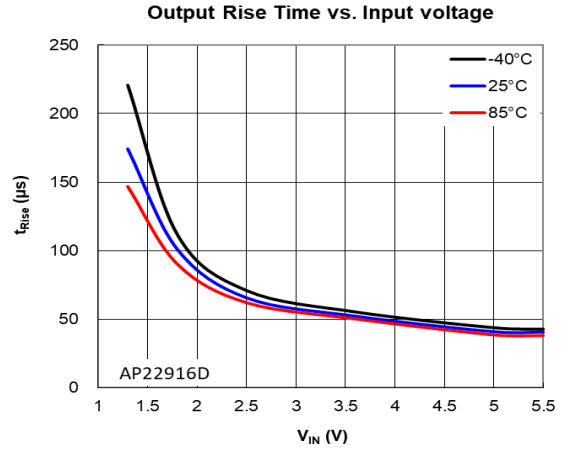
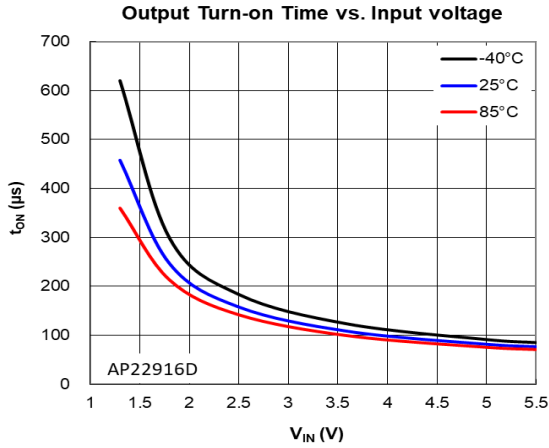

Typical Performance Characteristics ($C_{IN} = 1\mu F$, $C_{OUT} = 0.1\mu F$. All devices in this section are for 25°C, unless otherwise specified.) (continued)

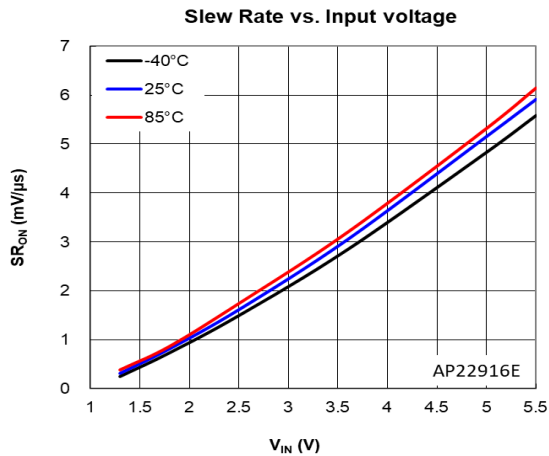
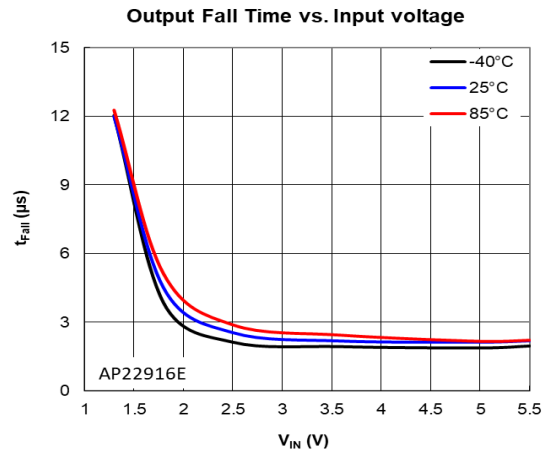
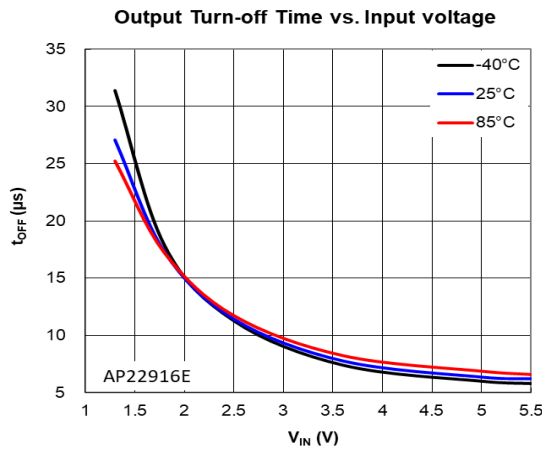
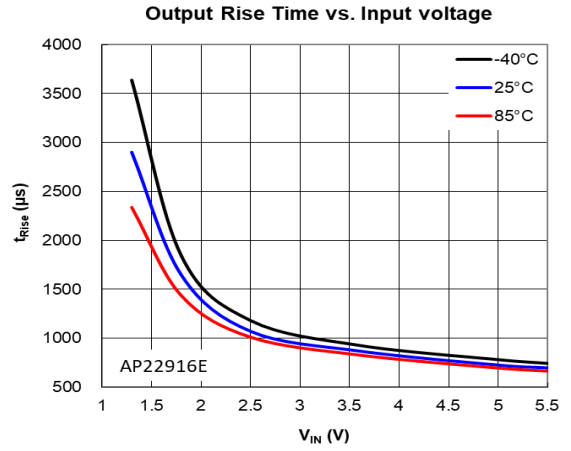
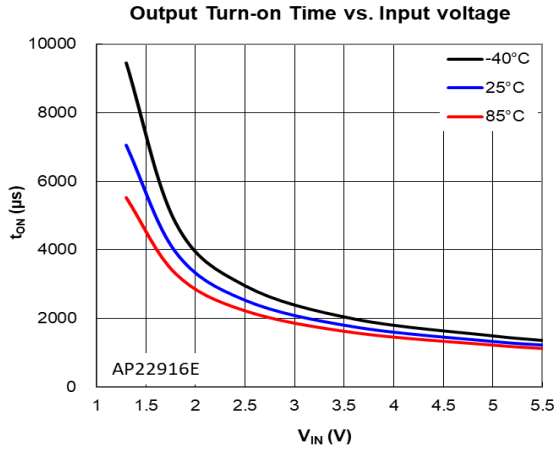

Typical Performance Characteristics ($C_{IN} = 1\mu\text{F}$, $C_{OUT} = 0.1\mu\text{F}$. All devices in this section are for 25°C , unless otherwise specified.) (continued)

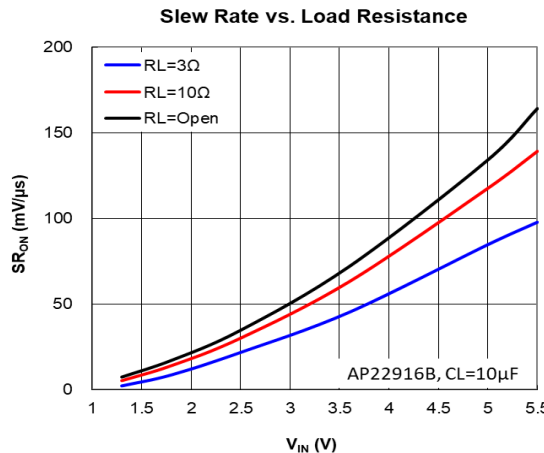
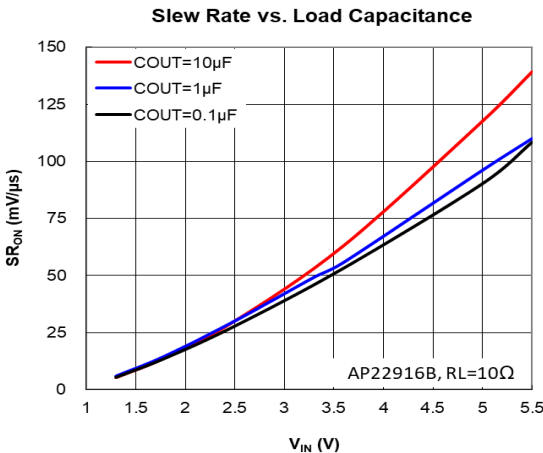
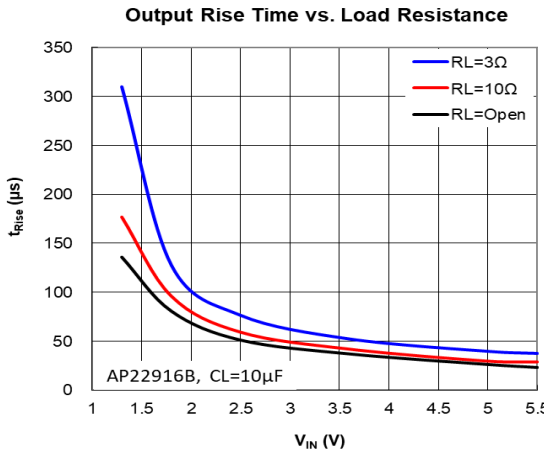
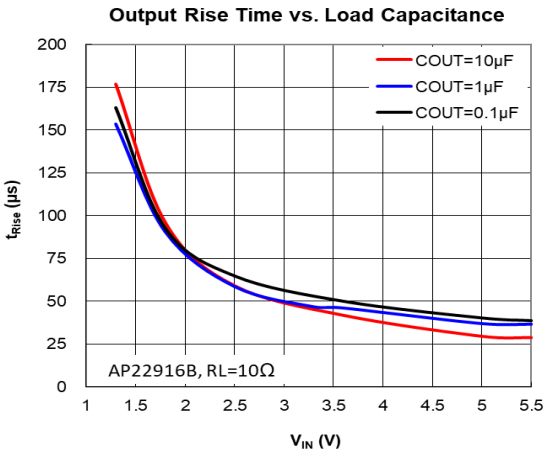
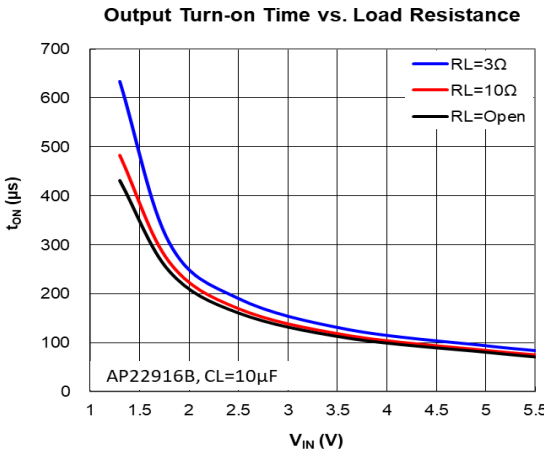
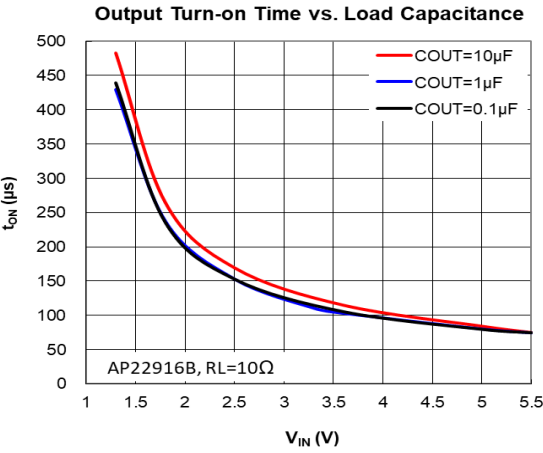

Typical Performance Characteristics ($C_{IN} = 1\mu F$, $C_{OUT} = 0.1\mu F$. All devices in this section are for 25°C, unless otherwise specified.) (continued)

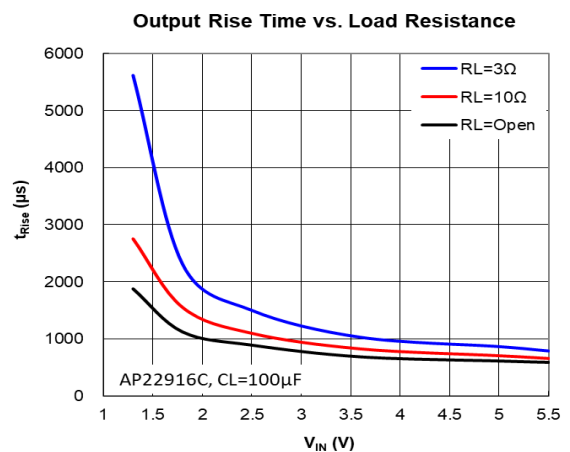
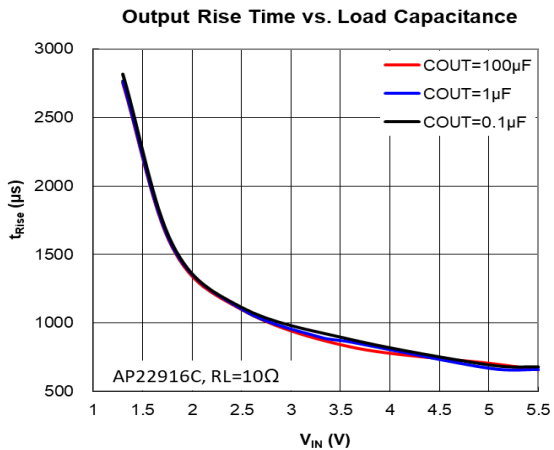
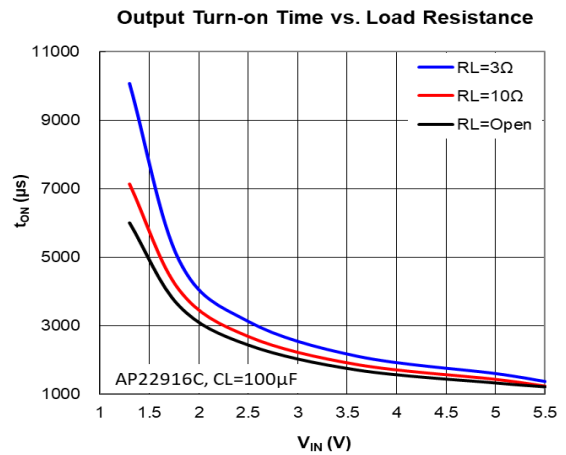
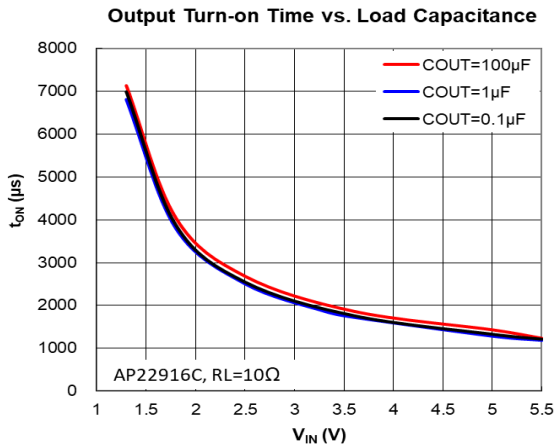
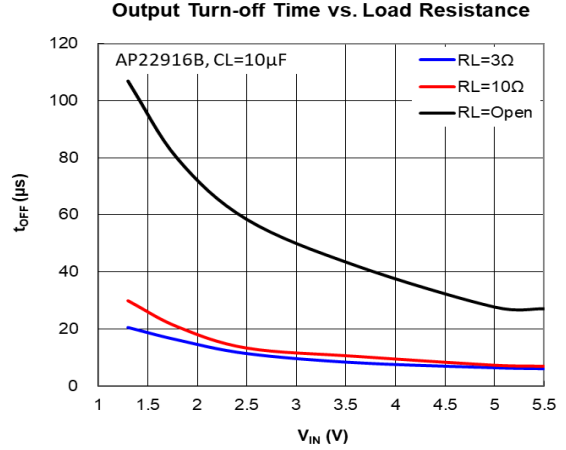
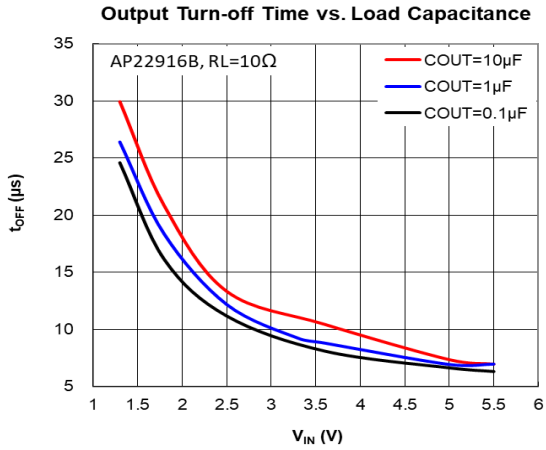

Typical Performance Characteristics ($C_{IN} = 1\mu F$, $C_{OUT} = 0.1\mu F$. All devices in this section are for 25°C, unless otherwise specified.) (continued)

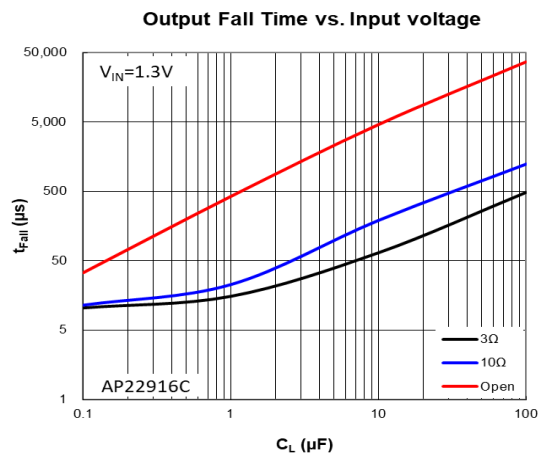
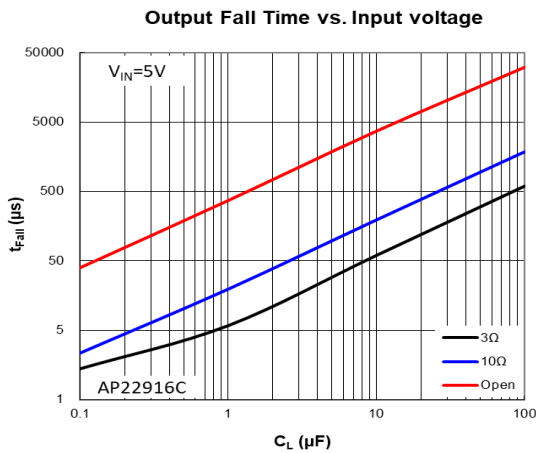
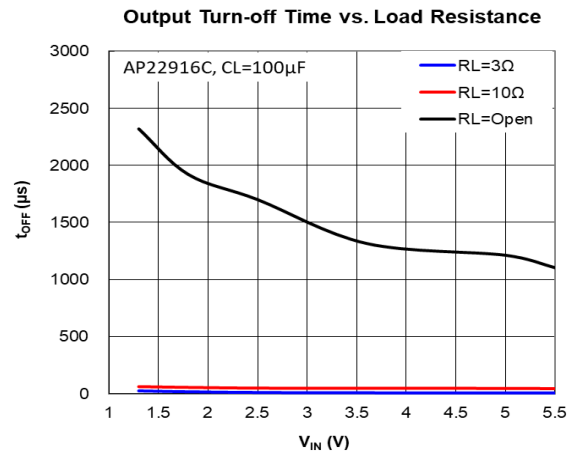
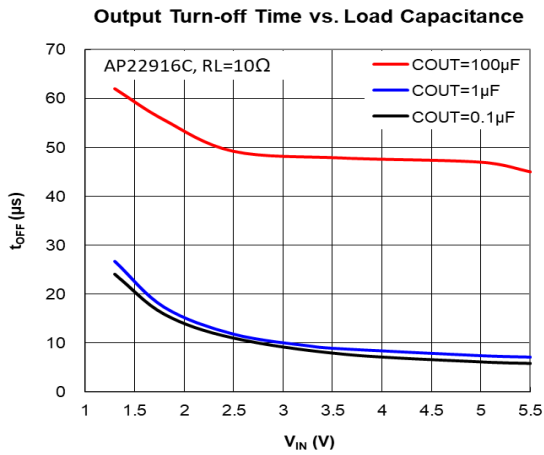
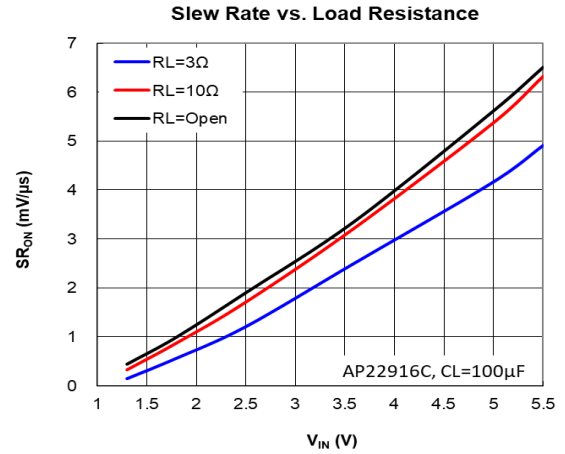
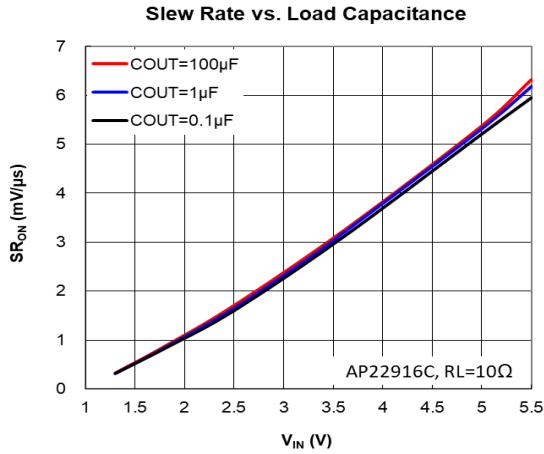

Typical Performance Characteristics ($C_{IN} = 1\mu\text{F}$, $C_{OUT} = 0.1\mu\text{F}$. All devices in this section are for 25°C , unless otherwise specified.) (continued)

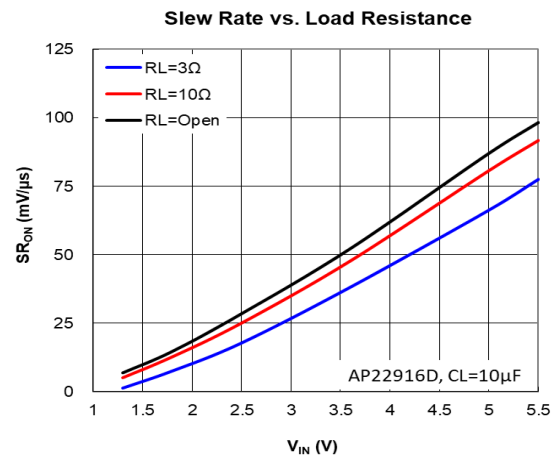
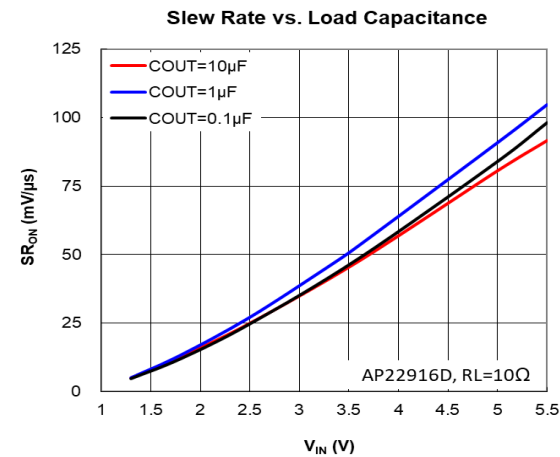
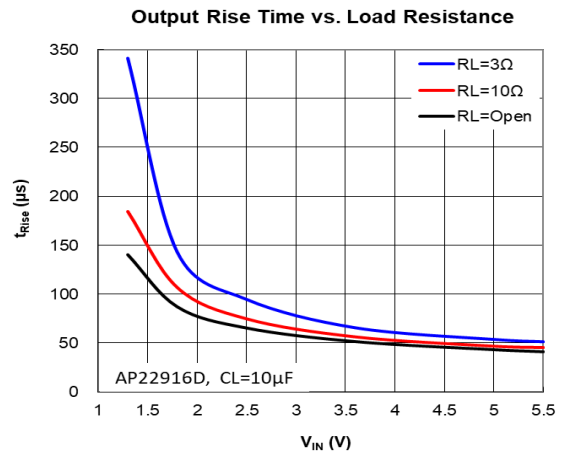
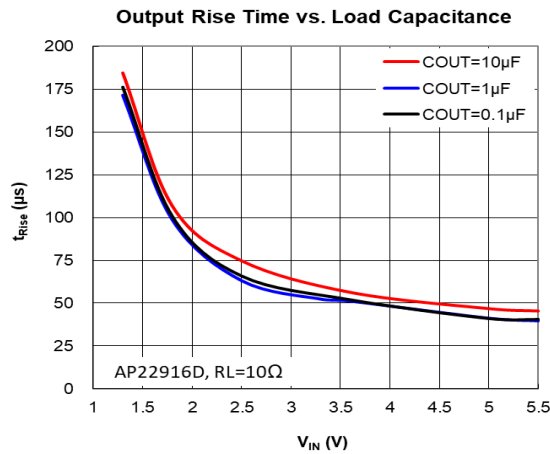
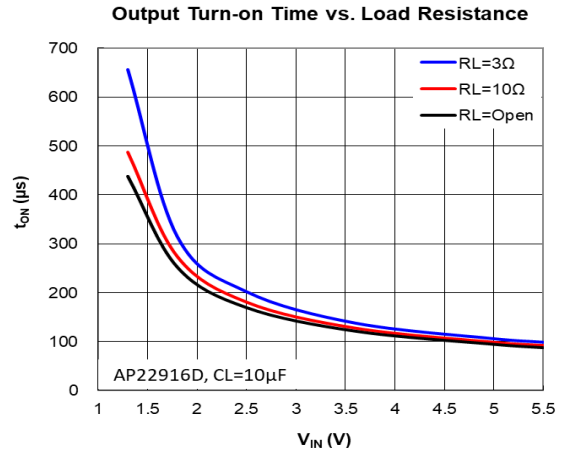
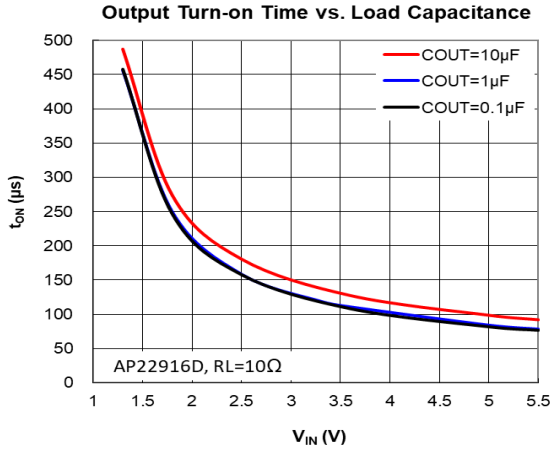

Typical Performance Characteristics ($C_{IN} = 1\mu F$, $C_{OUT} = 0.1\mu F$. All devices in this section are for 25°C, unless otherwise specified.) (continued)

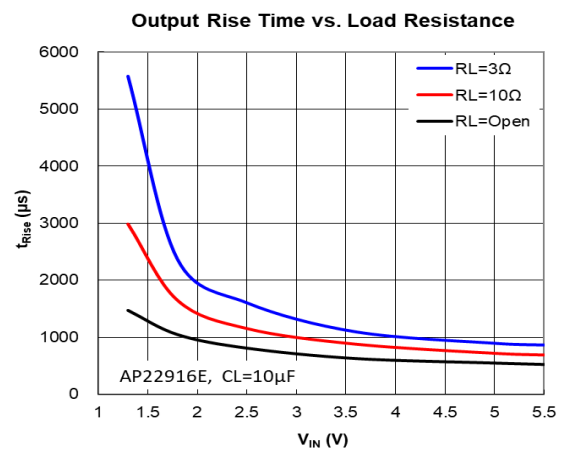
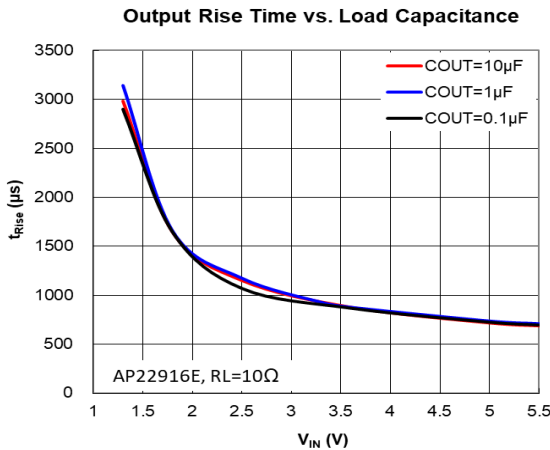
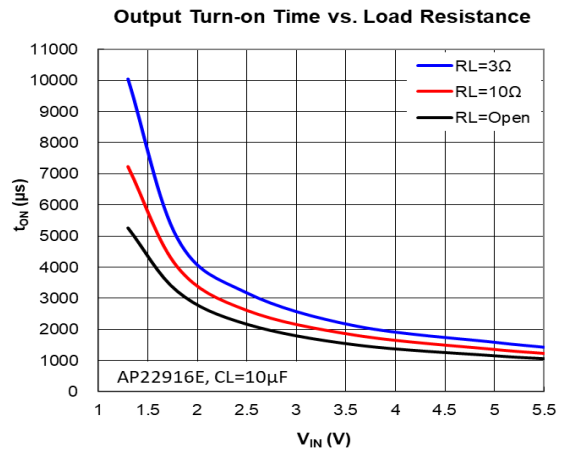
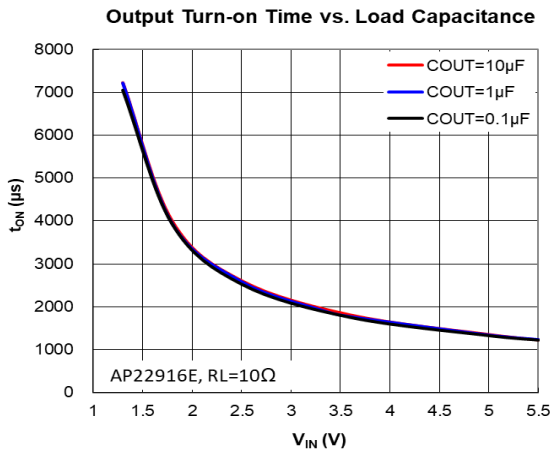
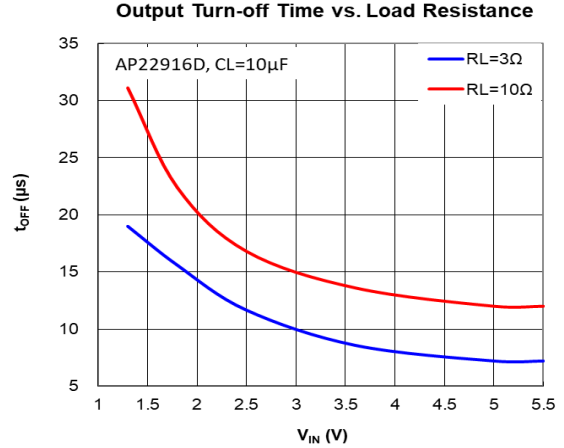
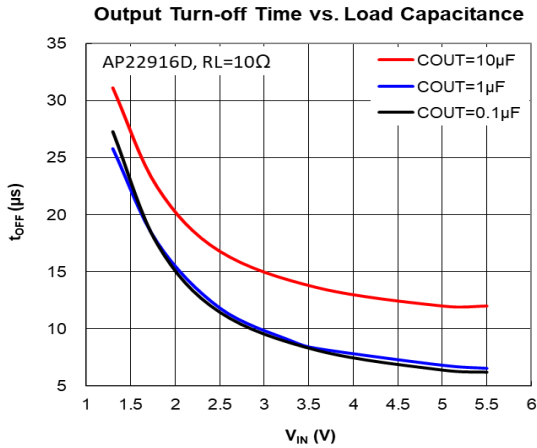

Typical Performance Characteristics ($C_{IN} = 1\mu F$, $C_{OUT} = 0.1\mu F$. All devices in this section are for 25°C, unless otherwise specified.) (continued)

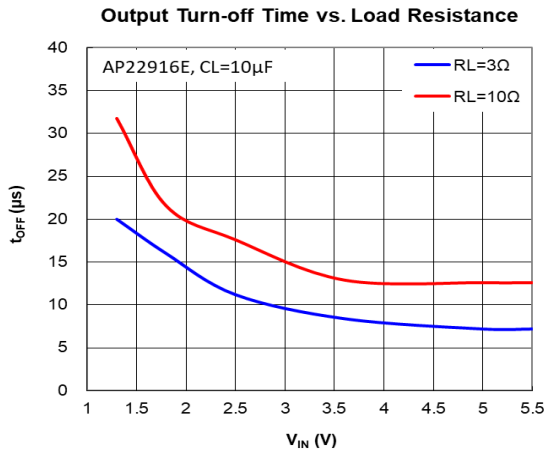
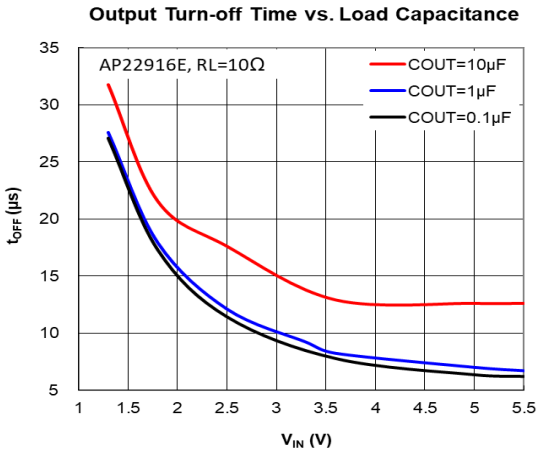
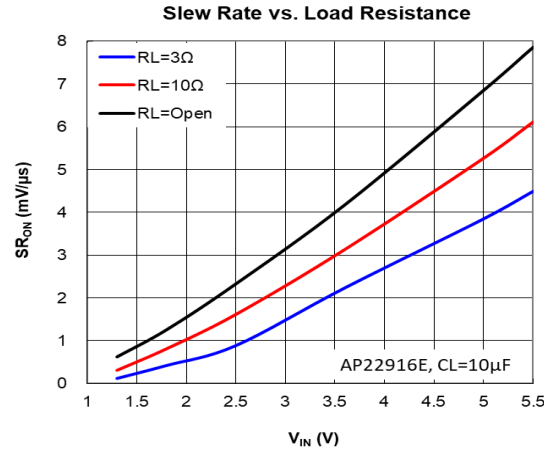
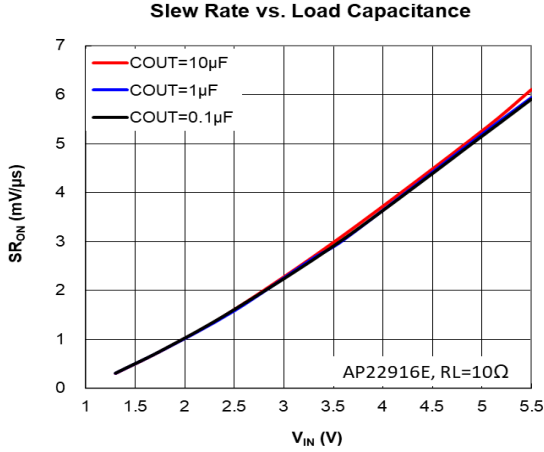

Typical Performance Characteristics ($C_{IN} = 1\mu F$, $C_{OUT} = 0.1\mu F$, unless otherwise specified.)

Output Turn-On Response

$V_{IN} = 5.0V$, $C_{IN} = 1\mu F$, $C_{OUT} = 0.1\mu F$, $R_L = 10\Omega$

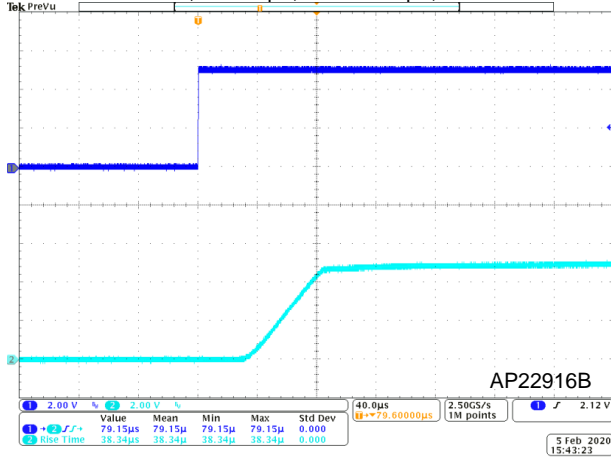

Output Turn-Off Response

$V_{IN} = 5.0V$, $C_{IN} = 1\mu F$, $C_{OUT} = 0.1\mu F$, $R_L = 10\Omega$

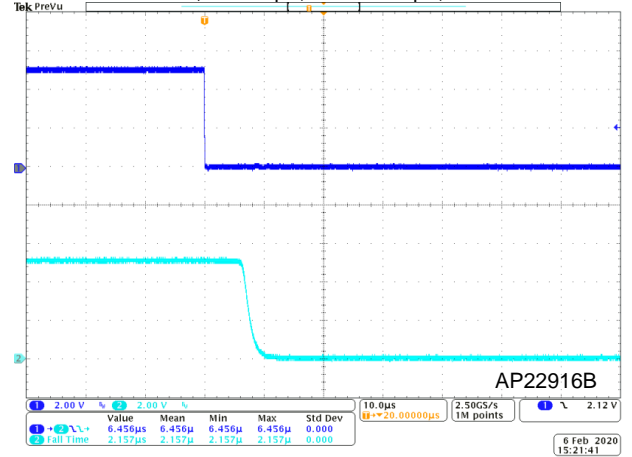

Output Turn-On Response

$V_{IN} = 3.6V$, $C_{IN} = 1\mu F$, $C_{OUT} = 0.1\mu F$, $R_L = 10\Omega$

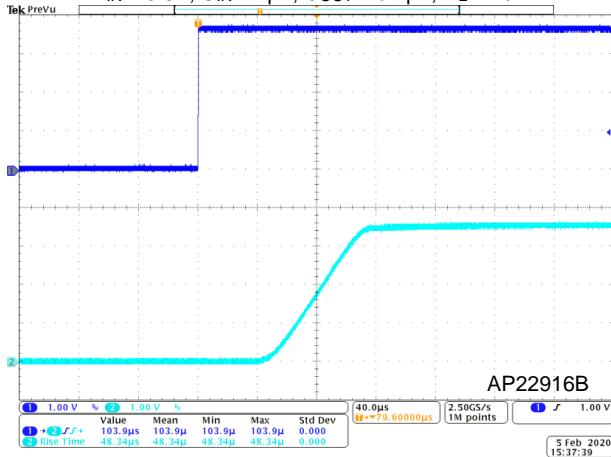

Output Turn-Off Response

$V_{IN} = 3.6V$, $C_{IN} = 1\mu F$, $C_{OUT} = 0.1\mu F$, $R_L = 10\Omega$

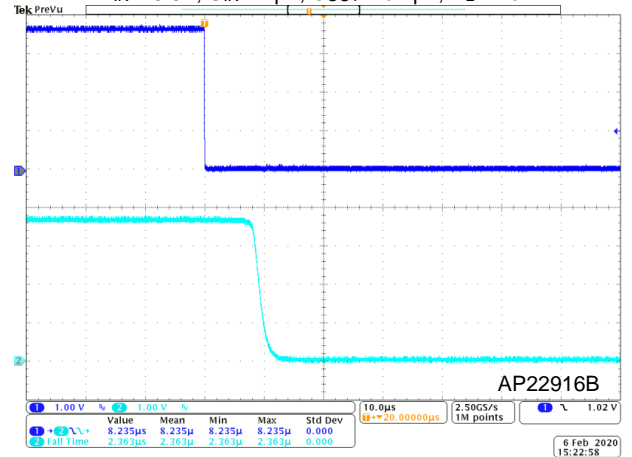

Output Turn-On Response

$V_{IN} = 2.5V$, $C_{IN} = 1\mu F$, $C_{OUT} = 0.1\mu F$, $R_L = 10\Omega$

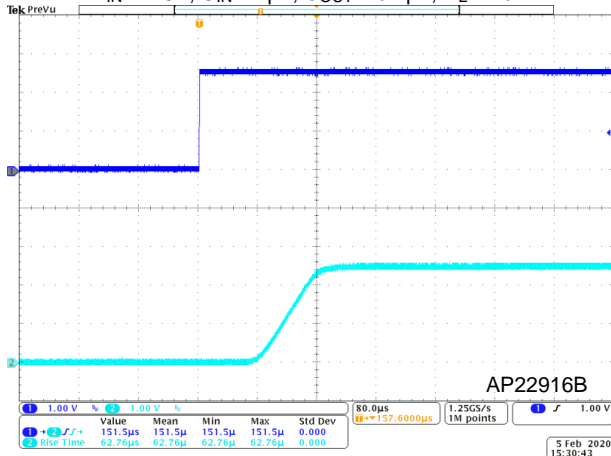

Output Turn-Off Response

$V_{IN} = 2.5V$, $C_{IN} = 1\mu F$, $C_{OUT} = 0.1\mu F$, $R_L = 10\Omega$

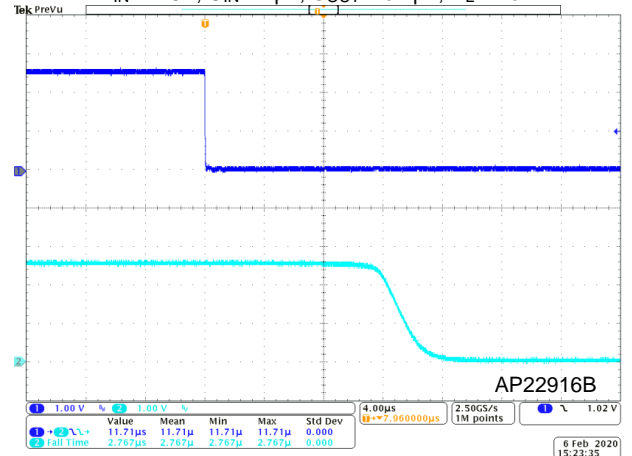

Typical Performance Characteristics ($C_{IN} = 1\mu F$, $C_{OUT} = 0.1\mu F$, unless otherwise specified.) (continued)

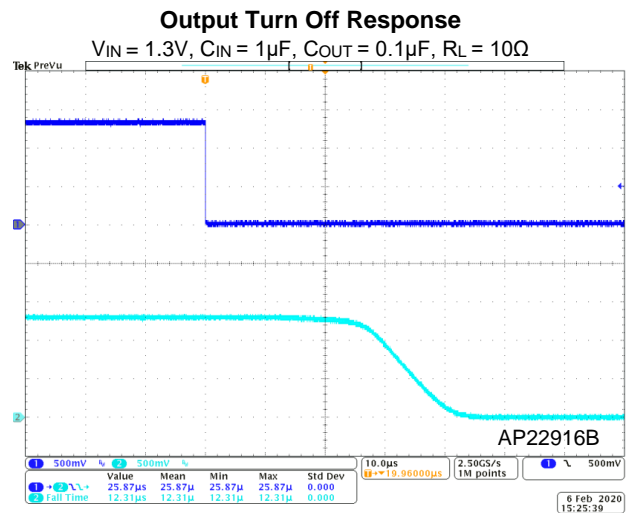
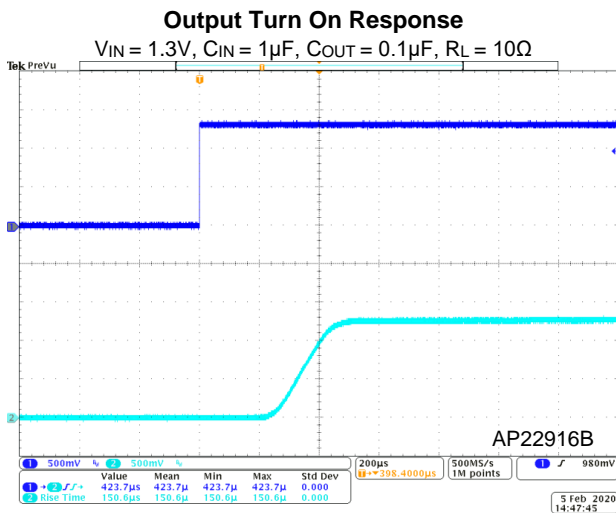
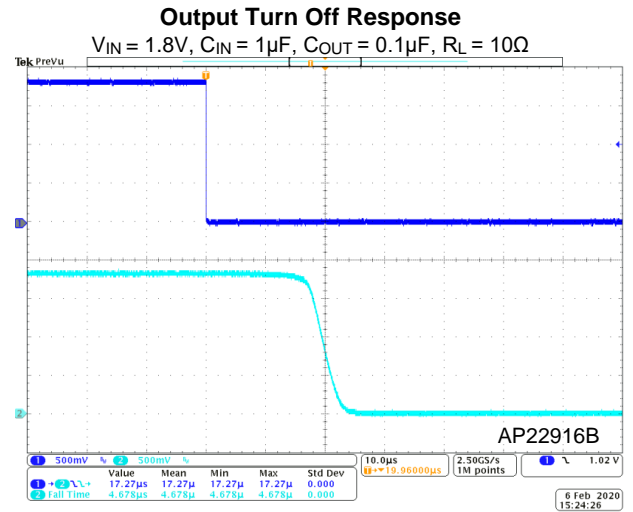
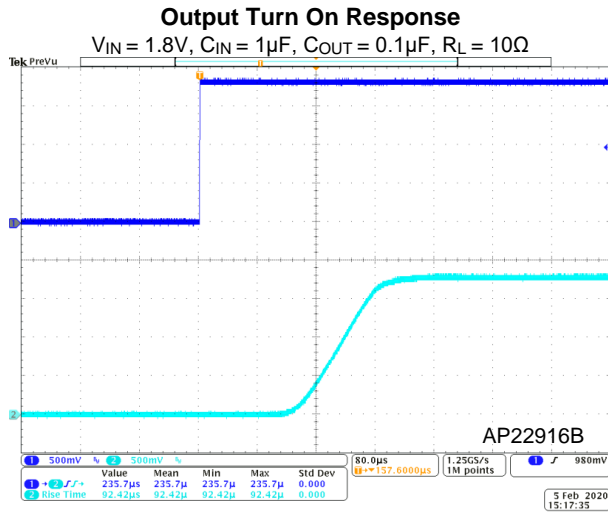

Typical Performance Characteristics ($C_{IN} = 1\mu F$, $C_{OUT} = 0.1\mu F$, unless otherwise specified.) (continued)

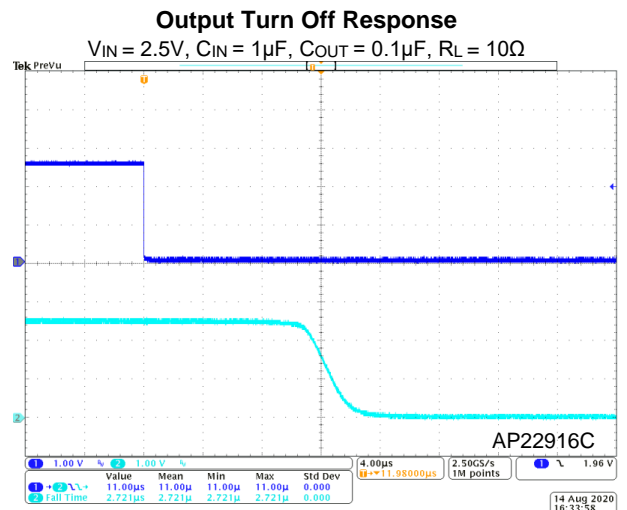
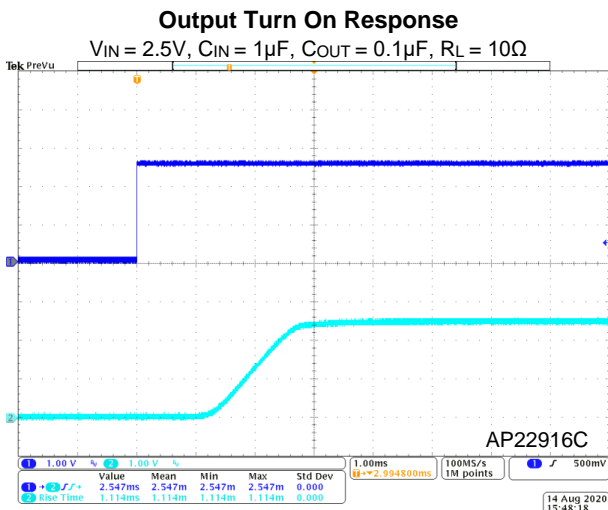
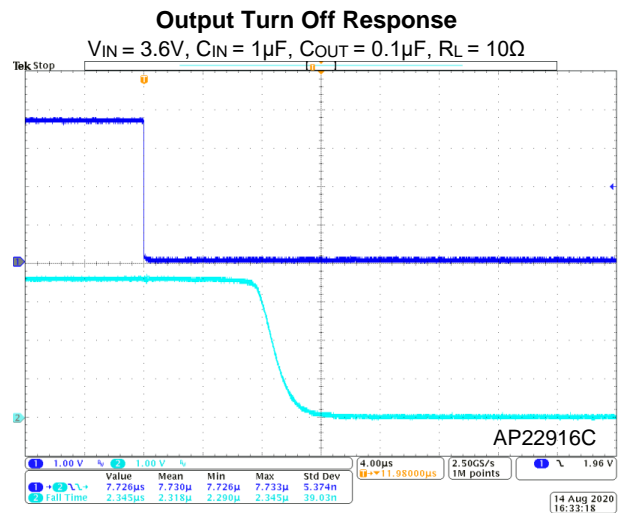
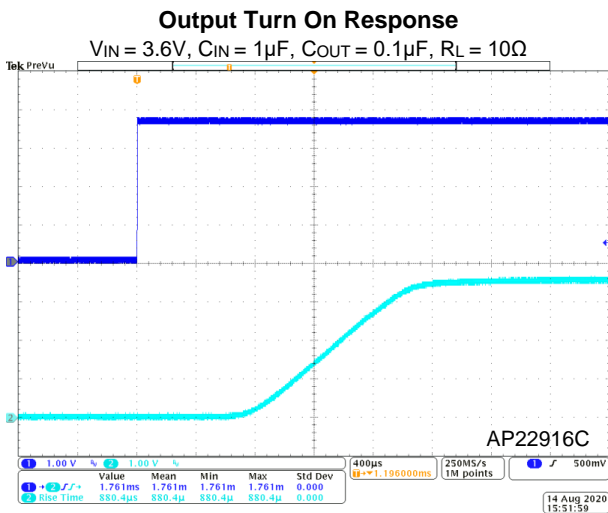
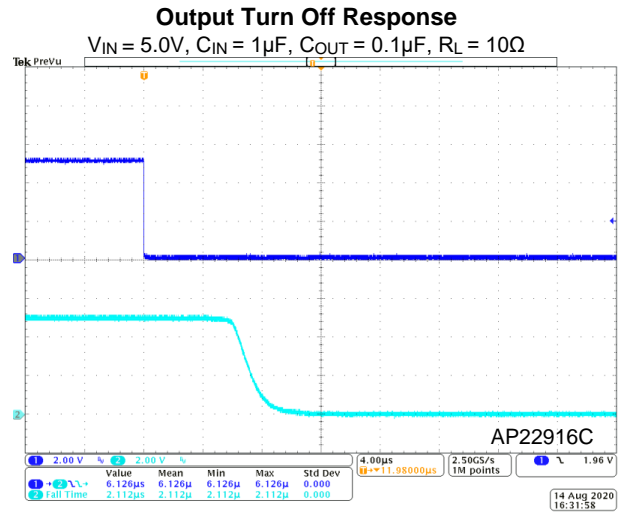
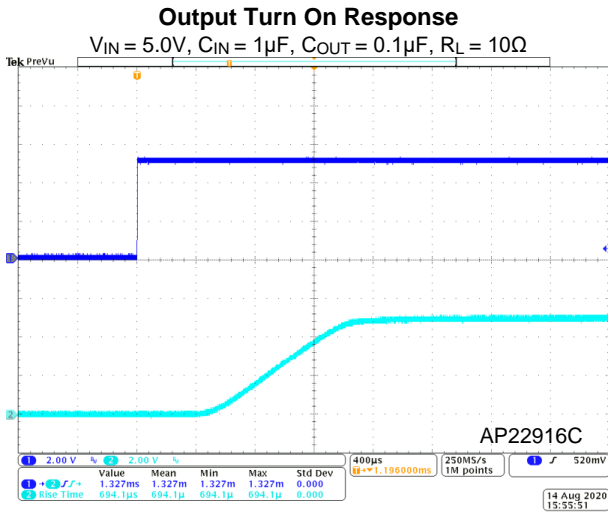

Typical Performance Characteristics ($C_{IN} = 1\mu F$, $C_{OUT} = 0.1\mu F$, unless otherwise specified.) (continued)

Output Turn On Response

$V_{IN} = 1.8V$, $C_{IN} = 1\mu F$, $C_{OUT} = 0.1\mu F$, $R_L = 10\Omega$

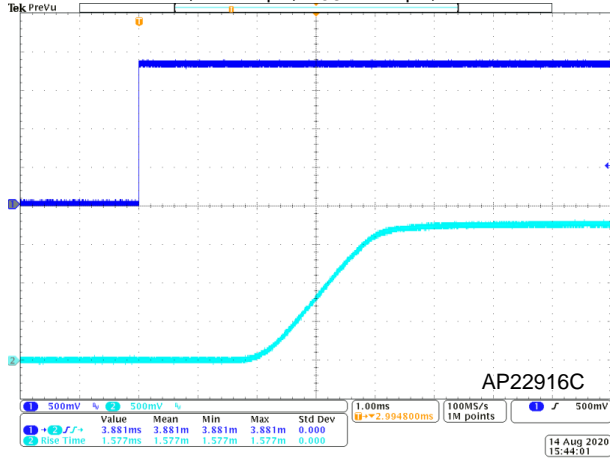

Output Turn Off Response

$V_{IN} = 1.8V$, $C_{IN} = 1\mu F$, $C_{OUT} = 0.1\mu F$, $R_L = 10\Omega$

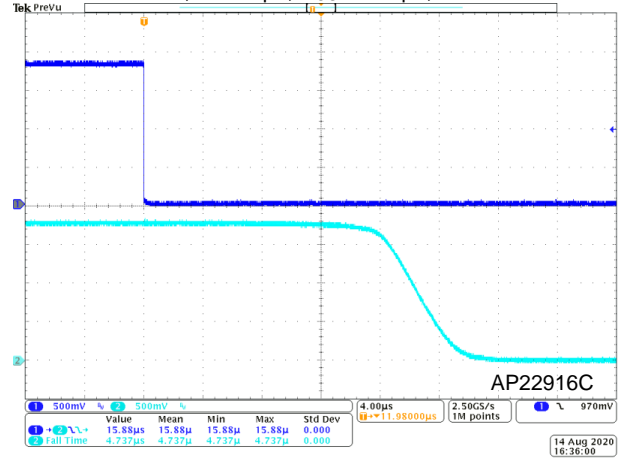

Output Turn On Response

$V_{IN} = 1.3V$, $C_{IN} = 1\mu F$, $C_{OUT} = 0.1\mu F$, $R_L = 10\Omega$

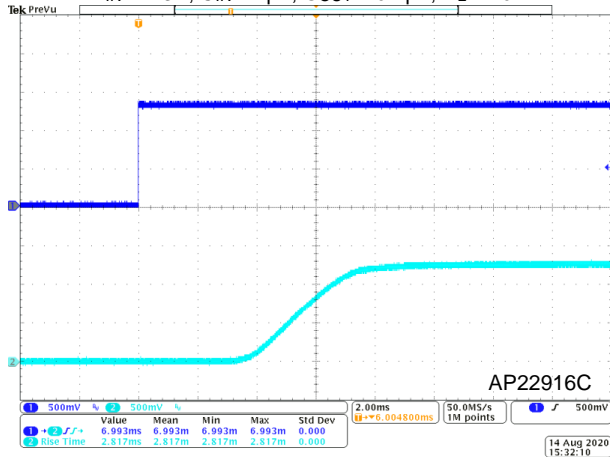

Output Turn Off Response

$V_{IN} = 1.3V$, $C_{IN} = 1\mu F$, $C_{OUT} = 0.1\mu F$, $R_L = 10\Omega$

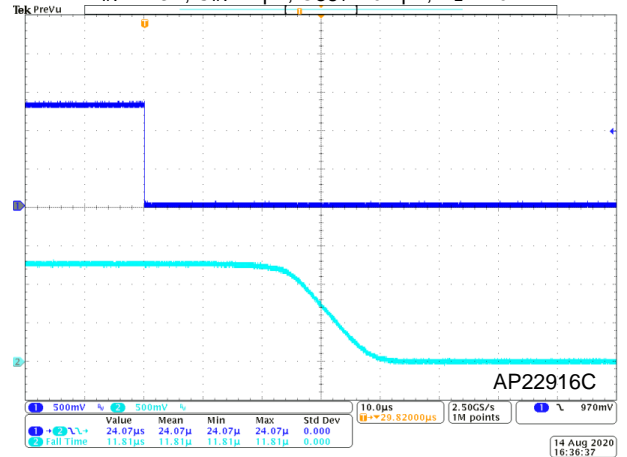

Typical Performance Characteristics ($C_{IN} = 1\mu F$, $C_{OUT} = 0.1\mu F$, unless otherwise specified.) (continued)

Output Turn-On Response

$V_{IN} = 5.0V$, $C_{IN} = 1\mu F$, $C_{OUT} = 0.1\mu F$, $R_L = 10\Omega$

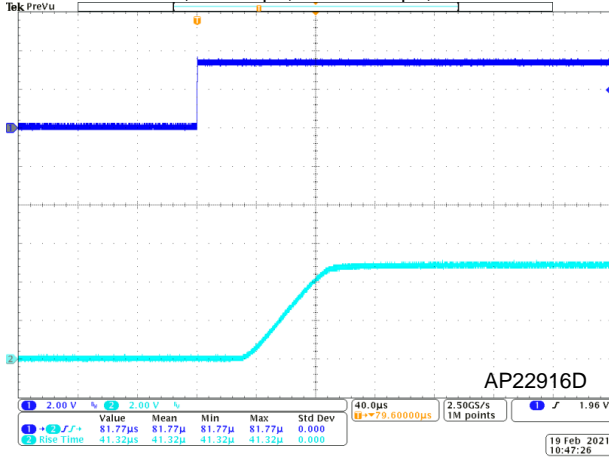

Output Turn-Off Response

$V_{IN} = 5.0V$, $C_{IN} = 1\mu F$, $C_{OUT} = 0.1\mu F$, $R_L = 10\Omega$

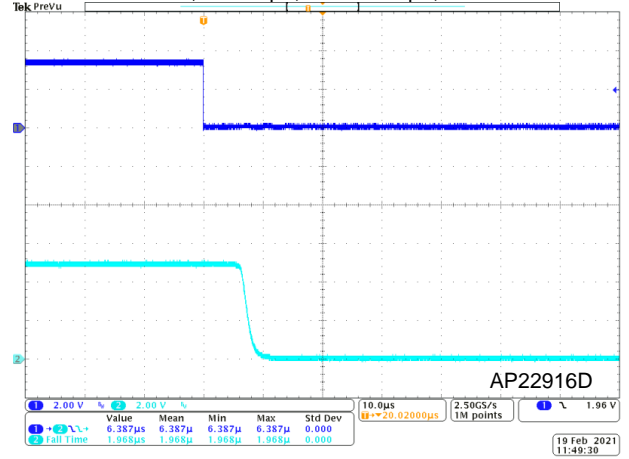

Output Turn-On Response

$V_{IN} = 3.6V$, $C_{IN} = 1\mu F$, $C_{OUT} = 0.1\mu F$, $R_L = 10\Omega$

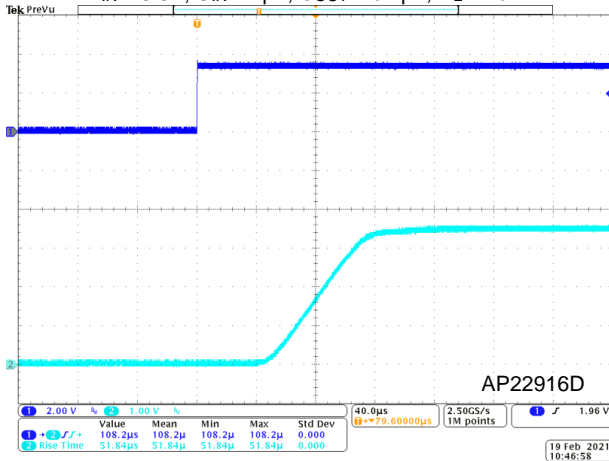

Output Turn-Off Response

$V_{IN} = 3.6V$, $C_{IN} = 1\mu F$, $C_{OUT} = 0.1\mu F$, $R_L = 10\Omega$

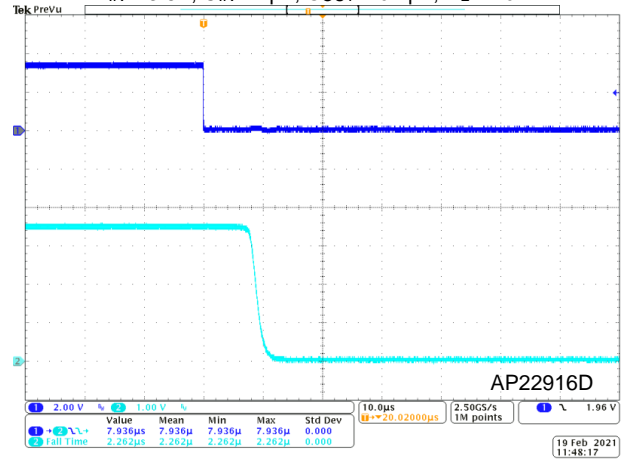

Output Turn-On Response

$V_{IN} = 2.5V$, $C_{IN} = 1\mu F$, $C_{OUT} = 0.1\mu F$, $R_L = 10\Omega$

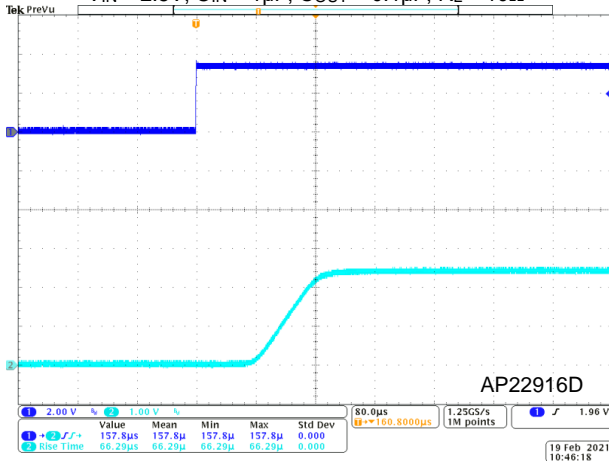

Output Turn-Off Response

$V_{IN} = 2.5V$, $C_{IN} = 1\mu F$, $C_{OUT} = 0.1\mu F$, $R_L = 10\Omega$

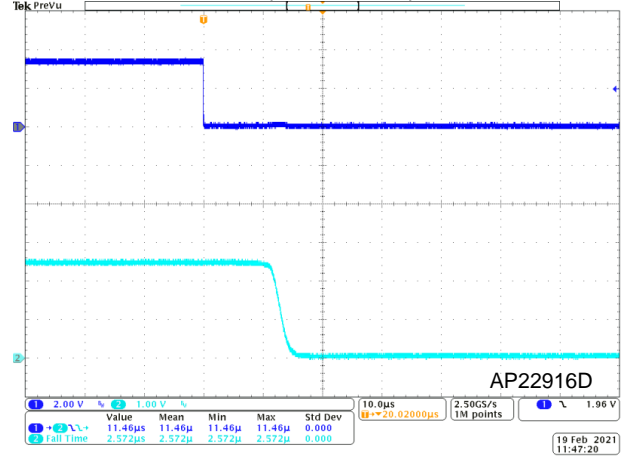

Typical Performance Characteristics ($C_{IN} = 1\mu F$, $C_{OUT} = 0.1\mu F$, unless otherwise specified.) (continued)

Output Turn On Response

$V_{IN} = 1.8V$, $C_{IN} = 1\mu F$, $C_{OUT} = 0.1\mu F$, $R_L = 10\Omega$

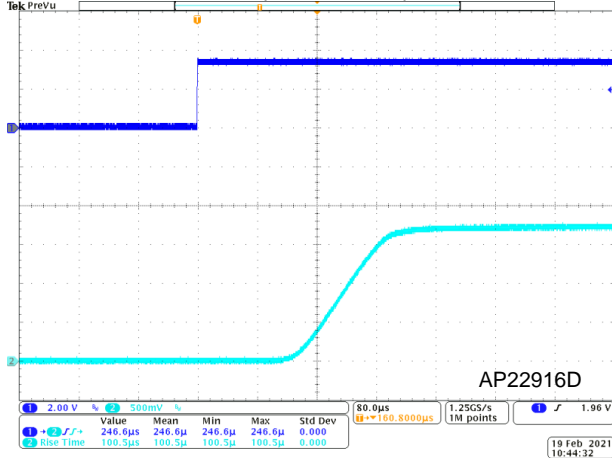

Output Turn Off Response

$V_{IN} = 1.8V$, $C_{IN} = 1\mu F$, $C_{OUT} = 0.1\mu F$, $R_L = 10\Omega$

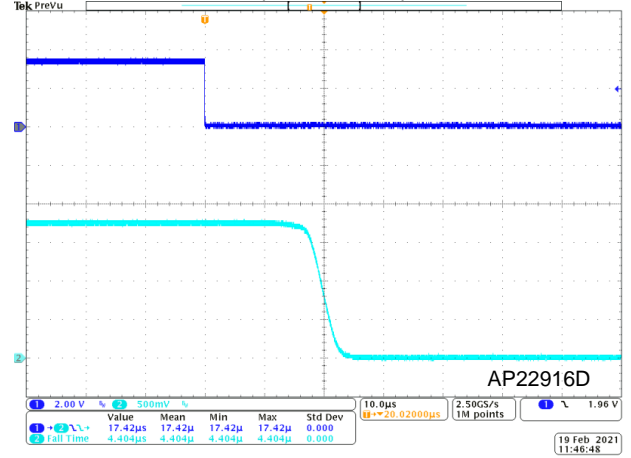

Output Turn On Response

$V_{IN} = 1.3V$, $C_{IN} = 1\mu F$, $C_{OUT} = 0.1\mu F$, $R_L = 10\Omega$

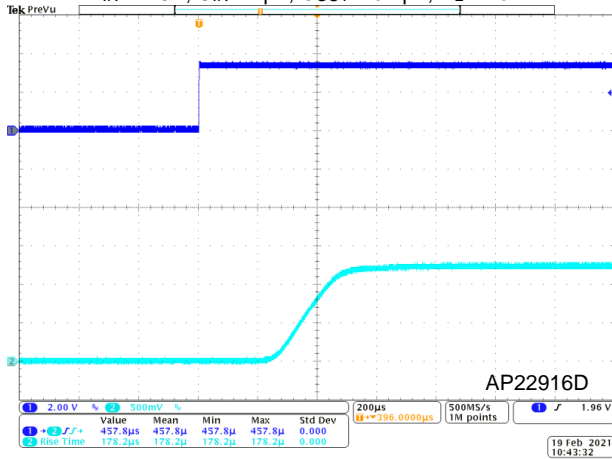

Output Turn Off Response

$V_{IN} = 1.3V$, $C_{IN} = 1\mu F$, $C_{OUT} = 0.1\mu F$, $R_L = 10\Omega$

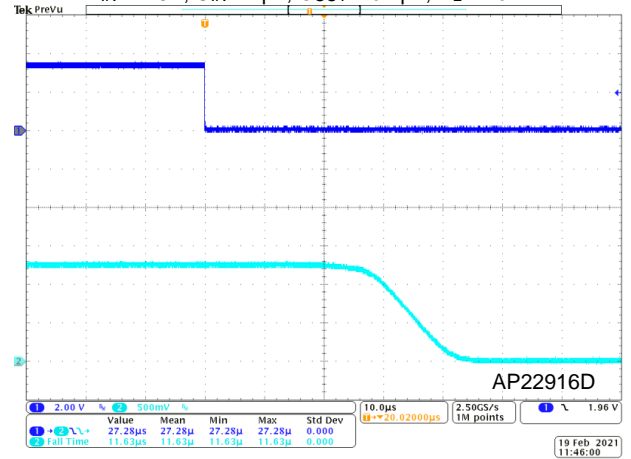

Typical Performance Characteristics ($C_{IN} = 1\mu F$, $C_{OUT} = 0.1\mu F$, unless otherwise specified.) (continued)

Output Turn-On Response

$V_{IN} = 5.0V$, $C_{IN} = 1\mu F$, $C_{OUT} = 0.1\mu F$, $R_L = 10\Omega$

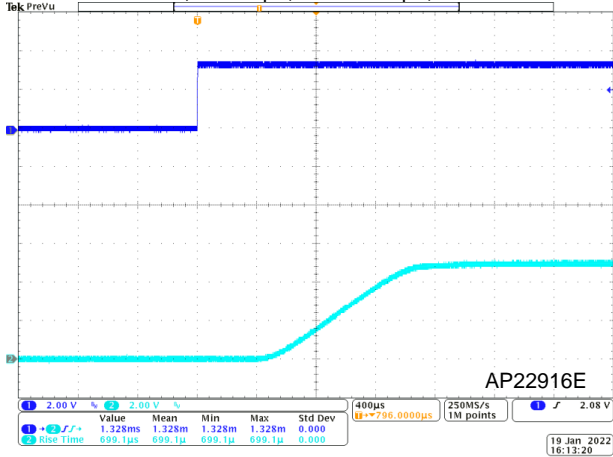

Output Turn-Off Response

$V_{IN} = 5.0V$, $C_{IN} = 1\mu F$, $C_{OUT} = 0.1\mu F$, $R_L = 10\Omega$

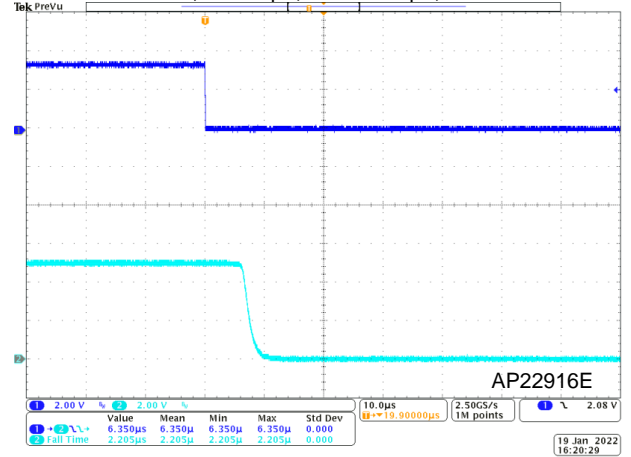

Output Turn-On Response

$V_{IN} = 3.6V$, $C_{IN} = 1\mu F$, $C_{OUT} = 0.1\mu F$, $R_L = 10\Omega$

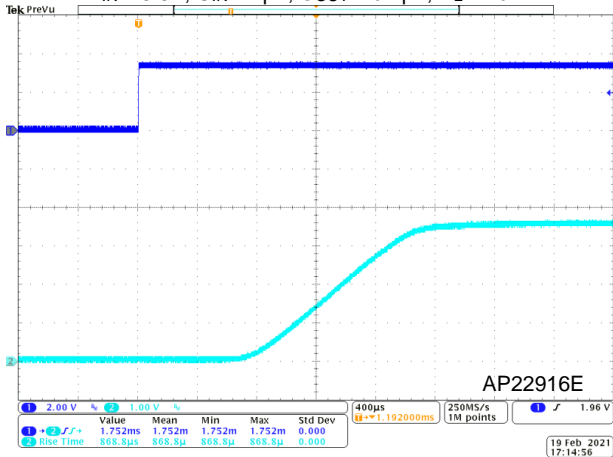

Output Turn-Off Response

$V_{IN} = 3.6V$, $C_{IN} = 1\mu F$, $C_{OUT} = 0.1\mu F$, $R_L = 10\Omega$

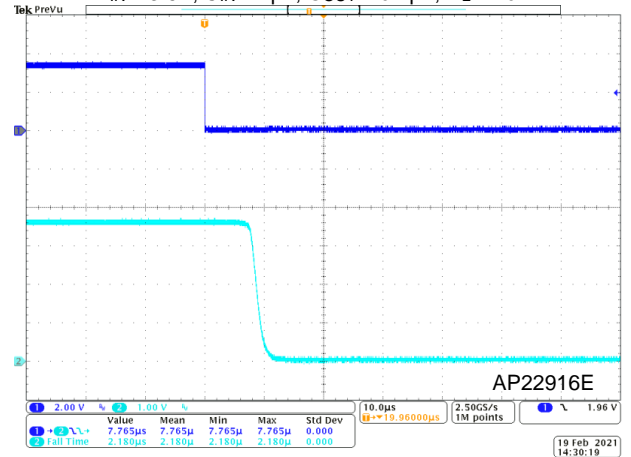

Output Turn-On Response

$V_{IN} = 2.5V$, $C_{IN} = 1\mu F$, $C_{OUT} = 0.1\mu F$, $R_L = 10\Omega$

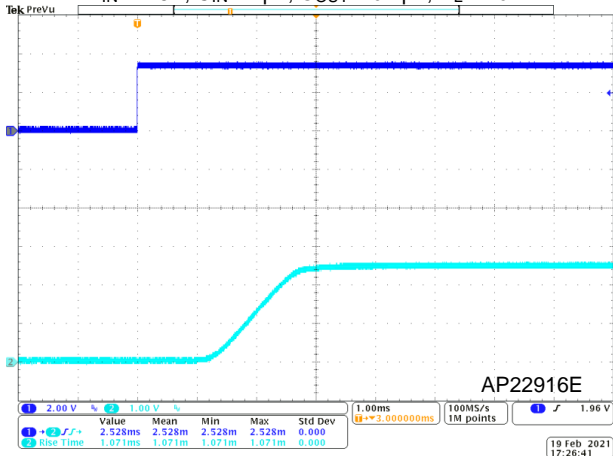

Output Turn-Off Response

$V_{IN} = 2.5V$, $C_{IN} = 1\mu F$, $C_{OUT} = 0.1\mu F$, $R_L = 10\Omega$

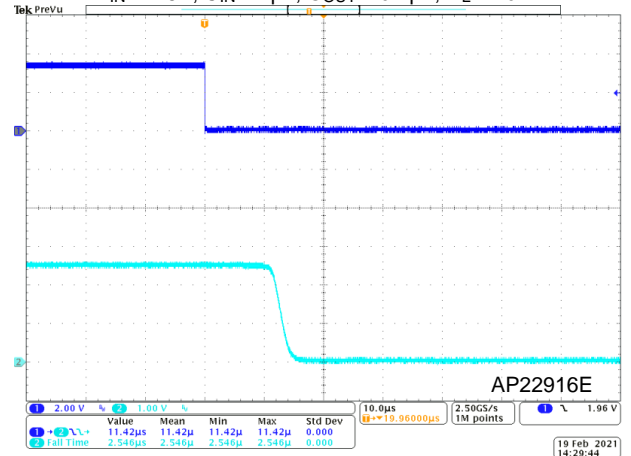

Typical Performance Characteristics ($C_{IN} = 1\mu F$, $C_{OUT} = 0.1\mu F$, unless otherwise specified.) (continued)

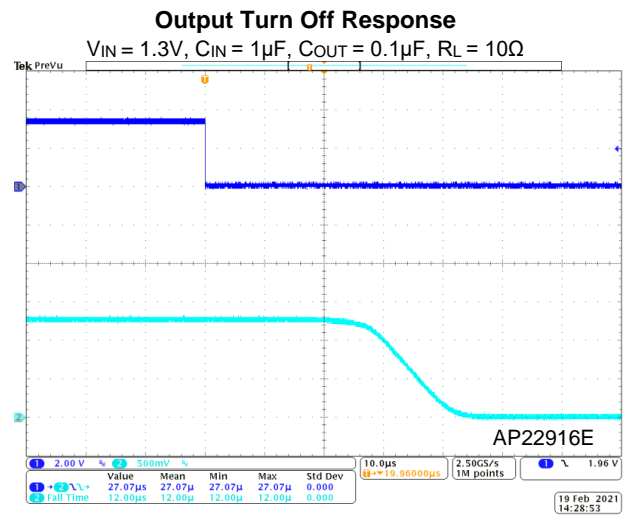
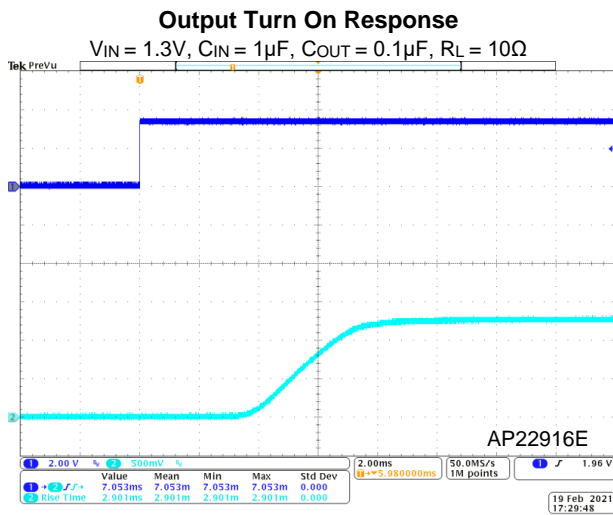
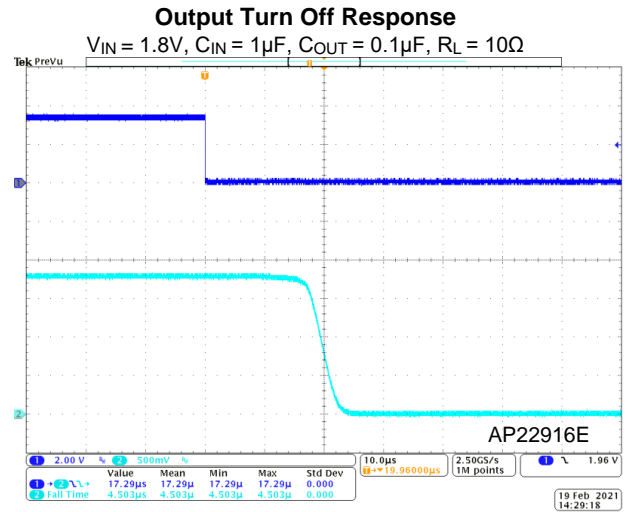
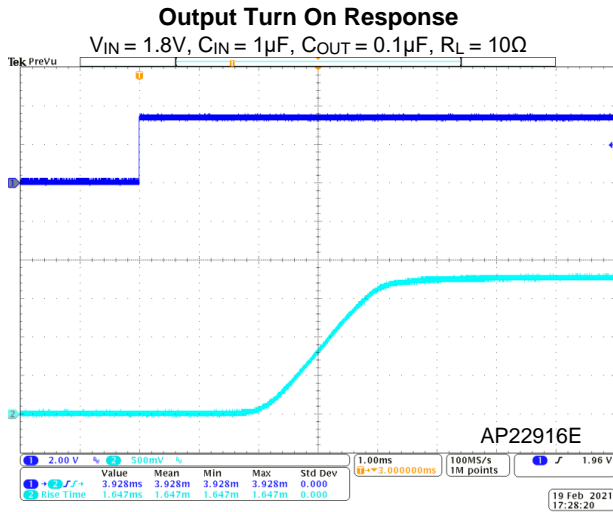

Application Information

Input Capacitor

A 1 μ F capacitor is recommended to connect between the V_{IN} and GND pins to decouple input power supply glitch and noise. The input capacitor has no specific type or ESR (equivalent series resistance) requirement. However, for higher current applications, ceramic capacitors are recommended due to their capability to withstand input current surges from low impedance sources, such as batteries in portable applications. This input capacitor must be located as close as possible to the device to assure input stability and less noise. For PCB layout, a wide copper trace is required for both V_{IN} and GND.

Output Capacitor

A 0.1 μ F to 1 μ F capacitor is recommended to connect between the V_{OUT} and GND pins to stabilize and accommodate load transient condition. The output capacitor has no specific type or ESR requirement. The amount of capacitance may be increased without limit. For PCB layout, the output capacitor must be placed as close as possible to the V_{OUT} and GND pins, and the traces must be kept as short as possible.

Enable/Shutdown Operation

The AP22916B/C is turned on by setting the ON pin high, and is turned off by pulling it low. To ensure proper operation, the signal source used to drive the ON pin must be able to swing above and below the specified turn-on/off voltage thresholds listed in the *Electrical Characteristics* section under V_{IL} and V_{IH}.

True Reverse Current Blocking

An internal reverse voltage comparator disables the power-switch when the output voltage (V_{OUT}) is driven higher than the input voltage (V_{IN}), by V_{RCB}, to quickly (10 μ s typ.) stop the flow of current towards the input side of the switch.

Reverse current protection is always active, even when the power switch is disabled. Additionally, undervoltage lockout (UVLO) protection turns the switch off if the input voltage is too low.

Discharge Operation

The AP22916/C offers a discharge option that helps to discharge the output charge when disabled.

Power Dissipation

The maximum IC junction temperature should be restricted to +125°C under normal operating conditions. The device power dissipation and proper sizing of the thermal plane are critical to avoid thermal shutdown and ensure reliable operation. Power dissipation of the device depends on input voltage and load conditions, and can be calculated by:

$$P_D = I_{OUT}^2 \times R_{DS(ON)} \quad (1)$$

However, the maximum power dissipation that can be handled by the device depends on the maximum junction to ambient thermal resistance, maximum ambient temperature, and maximum device junction temperature, which can be approximated by the equation below:

$$P_{D(MAX)} = \frac{(125^\circ\text{C} - T_A)}{\theta_{JA}} \quad (2)$$

Layout Guideline

Good PCB layout is important for improving the thermal performance of the device. All trace lengths should be kept as short as possible. The input (V_{IN}) and output (V_{OUT}) PCB traces should be as wide as possible to reduce stray impedance.

Use a ground plane to enhance the power dissipation capability of the device if applicable. Place input and output capacitors close to the device to minimize the effects of parasitic inductance.

Ordering Information

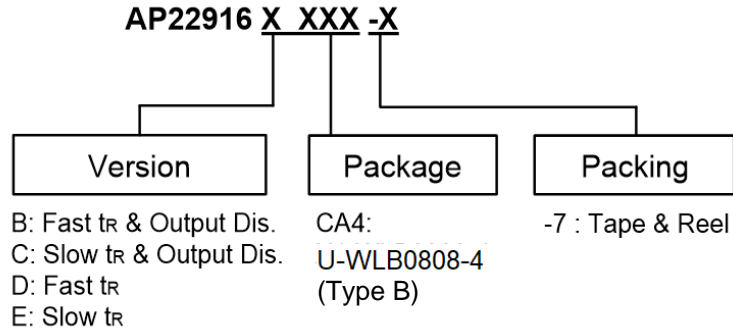

Orderable Part Number	Package Code	Package	7" Tape and Reel	
			Quantity	Part Number Suffix
AP22916BCA4-7	CA4	U-WLB0808-4 (Type B)	3,000/Tape & Reel	-7
AP22916CCA4-7	CA4	U-WLB0808-4 (Type B)	3,000/Tape & Reel	-7
AP22916DCA4-7	CA4	U-WLB0808-4 (Type B)	3,000/Tape & Reel	-7
AP22916ECA4-7	CA4	U-WLB0808-4 (Type B)	3,000/Tape & Reel	-7

Note: 8. For packaging details, go to our website at <https://www.diodes.com/design/support/packaging/diodes-packaging/>.

Marking Information

(Top View)

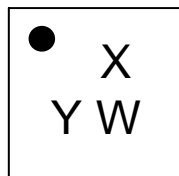

X : Identification Code
 Y : Year : 0~9
 W : Week : A~Z : 1~26 week;
 a~z : 27~52 week; z represents
 52 and 53 week

Part Number	Package	Identification Code
AP22916BCA4-7	U-WLB0808-4 (Type B)	5
AP22916CCA4-7	U-WLB0808-4 (Type B)	6
AP22916DCA4-7	U-WLB0808-4 (Type B)	7
AP22916ECA4-7	U-WLB0808-4 (Type B)	8

Package Outline Dimensions

Please see <http://www.diodes.com/package-outlines.html> for the latest version.

U-WLB0808-4 (Type B)

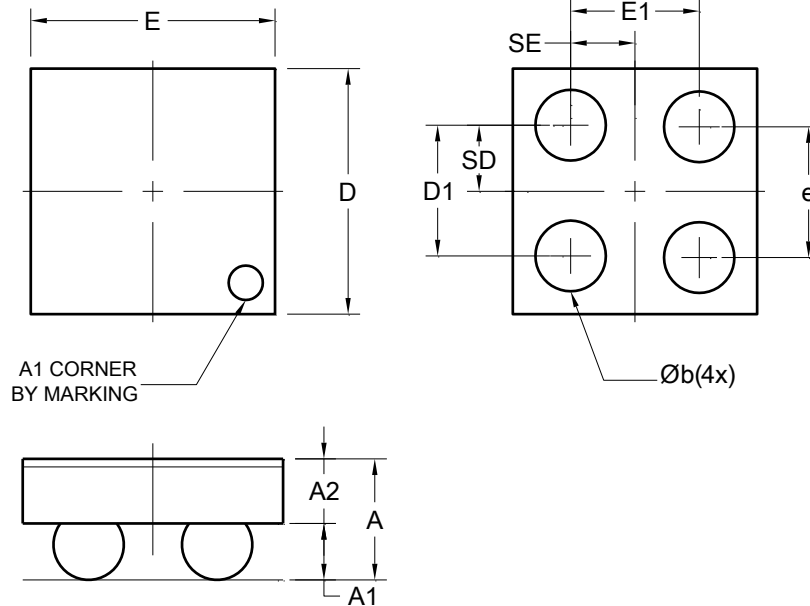

U-WLB0808-4 (Type B)			
Dim	Min	Max	Typ
A	0.405	0.505	0.455
A1	0.140	0.180	0.160
A2	0.245	0.295	0.270
b	0.220	0.260	0.240
D	0.765	0.795	0.780
D1	0.350	0.450	0.400
E	0.765	0.795	0.780
E1	0.350	0.450	0.400
e	0.400 TYP		
SD	0.200 TYP		
SE	0.200 TYP		
All Dimensions in mm			

Suggested Pad Layout

Please see <http://www.diodes.com/package-outlines.html> for the latest version.

U-WLB0808-4 (Type B)

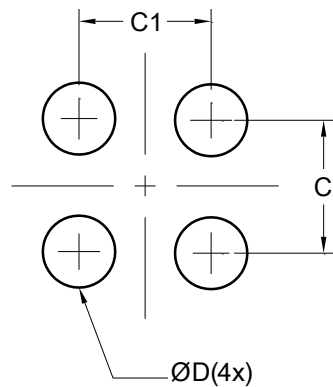

Dimensions	Value (in mm)
C	0.400
C1	0.400
D	0.240

IMPORTANT NOTICE

1. DIODES INCORPORATED (Diodes) AND ITS SUBSIDIARIES MAKE NO WARRANTY OF ANY KIND, EXPRESS OR IMPLIED, WITH REGARDS TO ANY INFORMATION CONTAINED IN THIS DOCUMENT, INCLUDING, BUT NOT LIMITED TO, THE IMPLIED WARRANTIES OF MERCHANTABILITY, FITNESS FOR A PARTICULAR PURPOSE OR NON-INFRINGEMENT OF THIRD PARTY INTELLECTUAL PROPERTY RIGHTS (AND THEIR EQUIVALENTS UNDER THE LAWS OF ANY JURISDICTION).
2. The Information contained herein is for informational purpose only and is provided only to illustrate the operation of Diodes' products described herein and application examples. Diodes does not assume any liability arising out of the application or use of this document or any product described herein. This document is intended for skilled and technically trained engineering customers and users who design with Diodes' products. Diodes' products may be used to facilitate safety-related applications; however, in all instances customers and users are responsible for (a) selecting the appropriate Diodes products for their applications, (b) evaluating the suitability of Diodes' products for their intended applications, (c) ensuring their applications, which incorporate Diodes' products, comply the applicable legal and regulatory requirements as well as safety and functional-safety related standards, and (d) ensuring they design with appropriate safeguards (including testing, validation, quality control techniques, redundancy, malfunction prevention, and appropriate treatment for aging degradation) to minimize the risks associated with their applications.
3. Diodes assumes no liability for any application-related information, support, assistance or feedback that may be provided by Diodes from time to time. Any customer or user of this document or products described herein will assume all risks and liabilities associated with such use, and will hold Diodes and all companies whose products are represented herein or on Diodes' websites, harmless against all damages and liabilities.
4. Products described herein may be covered by one or more United States, international or foreign patents and pending patent applications. Product names and markings noted herein may also be covered by one or more United States, international or foreign trademarks and trademark applications. Diodes does not convey any license under any of its intellectual property rights or the rights of any third parties (including third parties whose products and services may be described in this document or on Diodes' website) under this document.
5. Diodes' products are provided subject to Diodes' Standard Terms and Conditions of Sale (<https://www.diodes.com/about/company/terms-and-conditions/terms-and-conditions-of-sales/>) or other applicable terms. This document does not alter or expand the applicable warranties provided by Diodes. Diodes does not warrant or accept any liability whatsoever in respect of any products purchased through unauthorized sales channel.
6. Diodes' products and technology may not be used for or incorporated into any products or systems whose manufacture, use or sale is prohibited under any applicable laws and regulations. Should customers or users use Diodes' products in contravention of any applicable laws or regulations, or for any unintended or unauthorized application, customers and users will (a) be solely responsible for any damages, losses or penalties arising in connection therewith or as a result thereof, and (b) indemnify and hold Diodes and its representatives and agents harmless against any and all claims, damages, expenses, and attorney fees arising out of, directly or indirectly, any claim relating to any noncompliance with the applicable laws and regulations, as well as any unintended or unauthorized application.
7. While efforts have been made to ensure the information contained in this document is accurate, complete and current, it may contain technical inaccuracies, omissions and typographical errors. Diodes does not warrant that information contained in this document is error-free and Diodes is under no obligation to update or otherwise correct this information. Notwithstanding the foregoing, Diodes reserves the right to make modifications, enhancements, improvements, corrections or other changes without further notice to this document and any product described herein. This document is written in English but may be translated into multiple languages for reference. Only the English version of this document is the final and determinative format released by Diodes.
8. Any unauthorized copying, modification, distribution, transmission, display or other use of this document (or any portion hereof) is prohibited. Diodes assumes no responsibility for any losses incurred by the customers or users or any third parties arising from any such unauthorized use.
9. This Notice may be periodically updated with the most recent version available at <https://www.diodes.com/about/company/terms-and-conditions/important-notice>

The Diodes logo is a registered trademark of Diodes Incorporated in the United States and other countries.
All other trademarks are the property of their respective owners.
© 2023 Diodes Incorporated. All Rights Reserved.

www.diodes.com

Looking for pricing, stock, or lifecycle information?

Click below to explore more details on WIN SOURCE:

- ⊖ [View AP22916BCA4-7 on WIN SOURCE](#)
- ⊖ [Diodes Incorporated Information](#)

Optimize Your Supply Chain with WIN SOURCE Solutions

- ✓ Global Sourcing Solution
- ✓ Obsolete Management
- ✓ Cost Control Management
- ✓ Shortage Management
- ✓ Alternative Solution
- ✓ Excess Inventory Management