



**THE DATASHEET OF
AP7351D-30W5-7**



Description

The AP7351D is a low dropout regulator with high output voltage accuracy. The AP7351D includes a voltage reference, error amplifier, current limit circuit and an enable input to turn it on/off. With the integrated resistor network, fixed output voltage versions can be delivered.

With its ultra-low quiescent current, the AP7351D is well suited for low-power handheld, wearable devices, and other battery-operated devices requiring an extended time period until new battery replacement.

The AP7351D is available in the X2-DFN1010-4 (Type B) and SOT25 packages.

Features

- Low V_{IN} and Wide V_{IN} Range: 1.4V to 5.5V
- Guarantee Output Current, 150mA
- Output Voltage Range: 0.8V to 4.5V
- V_{OUT} Accuracy: $\pm 1\%$
- Ripple Rejection up to 60dB at 1kHz
- Quiescent Current as Low as 0.5 μ A
- Typical Standby Current 0.02 μ A
- Moisture Sensitivity: Level 1 per J-STD-020
- Terminals:
 - SOT25: Finish - Matte Tin Plated Leads, Solderable per MIL-STD-202, Method 208⁽³⁾
 - X2-DFN1010-4: Finish - NiPdAu over Copper Leads, Solderable per MIL-STD-202, Method 208⁽⁴⁾
- Weight:
 - SOT25: 0.016 grams (Approximate)
 - X2-DFN1010-4 (Type B): 0.001 grams (Approximate)
- **Totally Lead-Free & Fully RoHS Compliant (Notes 1 & 2)**
- **Halogen- and Antimony-Free. "Green" Device (Note 3)**
- **For automotive applications requiring specific change control (i.e. parts qualified to AEC-Q100, PPAP capable, and manufactured in IATF 16949 certified facilities), please [contact us](mailto:contact@diodes.com) or your local Diodes representative. <https://www.diodes.com/quality/product-definitions/>**

Pin Assignments

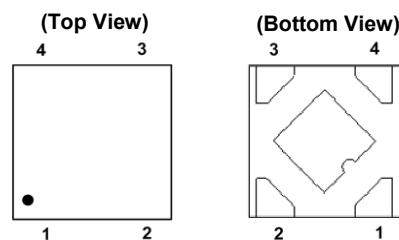

X2-DFN1010-4 (Type B)

PIN1 – V_{OUT} , PIN2 – GND, PIN3 – EN, PIN4 – V_{IN}

(Top View)

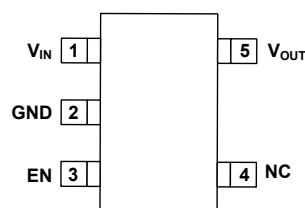

SOT25

Applications

- Wearable Electronics
- Sensor Module for Internet-Of-Things (IOT)
- Wireless Communication Module
- Battery-Operated Device
- Camera
- Image Sensor

Typical Applications Circuit (Note 4)

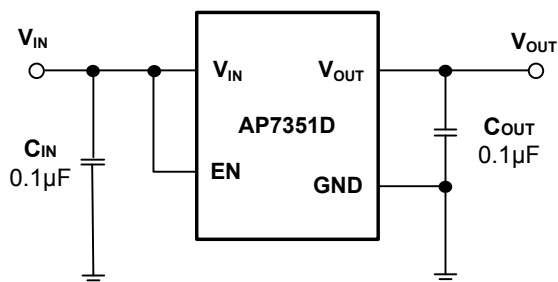

- Notes:
1. No purposely added lead. Fully EU Directive 2002/95/EC (RoHS), 2011/65/EU (RoHS 2) & 2015/863/EU (RoHS 3) compliant.
 2. See <https://www.diodes.com/quality/lead-free/> for more information about Diodes Incorporated's definitions of Halogen- and Antimony-free, "Green" and Lead-free.
 3. Halogen- and Antimony-free "Green" products are defined as those which contain <900ppm bromine, <900ppm chlorine (<1500ppm total Br + Cl) and <1000ppm antimony compounds.
 4. X5R- and X7R-type capacitors are suggested due to their minimal variation in value and ESR over temperature.

Pin Descriptions

Pin Number		Pin Name	Function
X2-DFN1010-4 (Type B)	SOT25		
1	5	V _{OUT}	Output Voltage Pin
2	2	GND	Ground
3	3	EN	Enable Pin This pin should be driven either high or low and must not be floating. Driving this pin high enables the regulator, while pulling it low puts the regulator into shutdown mode
4	1	V _{IN}	Power Input Pin
—	4	NC	No connection for fixed V _{OUT} versions.
EP	—	Exposed Pad	In PCB layout, prefer to use large copper area to cover this pad for better thermal dissipation, then connect this area to GND or leave it open. However, do not use it as GND electrode function alone

Functional Block Diagram

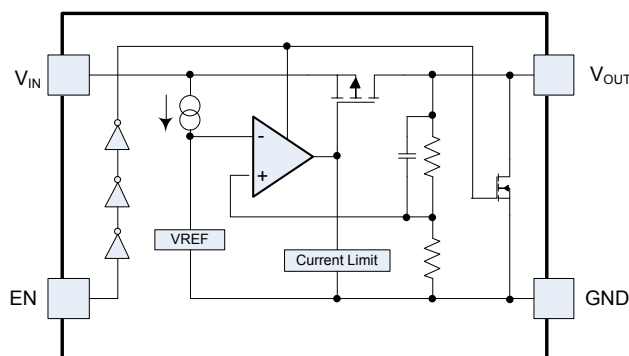

AP7351D (With Discharge)

Absolute Maximum Ratings (Note 5)

Symbol	Parameter	Ratings	Unit
ESD HBM	Human Body Mode ESD Protection	> 2	kV
ESD CDM	Charge Device Model	±500	V
V _{IN}	Input Voltage	6.0	V
V _{EN}	Input Voltage for EN Pin	6.0	V
V _{OUT}	Output Voltage	-0.3 to V _{IN} + 0.3	V
P _D	Power Dissipation	400	mW
T _A	Operating Ambient Temperature	-40 to +85	°C
T _J	Operating Junction Temperature	+125	°C
T _{STG}	Storage Temperature	-55 to +125	°C

Note: 5. Stresses beyond those listed under *Absolute Maximum Ratings* can cause permanent damage to the device. These are stress ratings only and functional operation of the device at these conditions is not implied. Exposure to absolute-maximum-rated conditions for extended periods can affect device reliability.

Recommended Operating Conditions

Symbol	Parameter	Min	Max	Unit
V _{IN}	Input Voltage	1.4	5.5	V
I _{OUT}	Output Current	0	150	mA
T _A	Operating Ambient Temperature	-40	+85	°C

Electrical Characteristics (@ $T_A = +25^\circ\text{C}$, $V_{EN} = V_{IN} = V_{OUT} + 1\text{V}$ ($1.5\text{V} < V_{OUT} \leq 4.5\text{V}$), $V_{EN} = V_{IN} = 2.5\text{V}$ ($V_{OUT} \leq 1.5\text{V}$), $I_{OUT} = 1\text{mA}$, $C_{IN} = C_{OUT} = 0.1\mu\text{F}$, unless otherwise specified.)

Parameter	Conditions	Min	Typ	Max	Unit	
Input Voltage	$T_A = -40^\circ\text{C}$ to $+85^\circ\text{C}$	1.4	—	5.5	V	
Output Voltage Accuracy	$V_{OUT} > 2.0\text{V}$ $I_{OUT} = 5\text{mA}$	$T_A = +25^\circ\text{C}$	-1	—	+1	%
		$T_A = -40^\circ\text{C}$ to $+85^\circ\text{C}$	-2	—	+2	
	$V_{OUT} \leq 2.0\text{V}$ $I_{OUT} = 5\text{mA}$	$T_A = +25^\circ\text{C}$	-40	—	40	mV
		$T_A = -40^\circ\text{C}$ to $+85^\circ\text{C}$	-80	—	80	
Line Regulation ($\Delta V_{OUT}/\Delta V_{IN}/V_{OUT}$)	MAX ($V_{OUT} + 1.0\text{V}$, 2.5V) $\leq V_{IN} \leq 5.5\text{V}$ (All Versions Except 4.5V)	—	0.05	0.2	%/V	
Load Regulation ($\Delta V_{OUT}/\Delta I_{OUT}$)	$1\text{mA} \leq I_{OUT} \leq 150\text{mA}$ (all versions except 4.5V)	—	30	—	mV	
	$1\text{mA} \leq I_{OUT} \leq 150\text{mA}$ (applicable to 4.5V version)	—	45	—	mV	
Short Circuit Current Limit (Note 6)	$V_{OUT} = 0\text{V}$	—	60	—	mA	
Quiescent Current (Note 7)	$I_{OUT} = 0\text{mA}$	—	0.5	1	μA	
Standby Current ($I_{STANDBY}$)	Set EN low, No load	—	0.02	0.2	μA	
Output Current	—	150	—	—	mA	
PSRR	$V_{OUT} = 3.3\text{V}$, $I_{OUT} = 20\text{mA}$, $f = 1\text{kHz}$	—	60	—	dB	
Dropout Voltage (Note 8)	$I_{OUT} = 150\text{mA}$	$V_{OUT} = 0.8\text{V}$	—	0.9	1.4	V
		$V_{OUT} = 0.9\text{V}$	—	0.9	1.35	
		$V_{OUT} = 1.0\text{V}$	—	0.8	1.20	
		$V_{OUT} = 1.2\text{V}$	—	0.60	0.90	
		$V_{OUT} = 1.5\text{V}$	—	0.43	0.75	
		$V_{OUT} = 1.8\text{V}$	—	0.33	0.60	
		$V_{OUT} = 1.85\text{V}$	—	0.32	0.58	
		$V_{OUT} = 2.5\text{V}$	—	0.22	0.48	
		$V_{OUT} = 2.7\text{V}$	—	0.2	0.45	
		$V_{OUT} = 2.8\text{V}$	—	0.19	0.40	
		$V_{OUT} = 3.0\text{V}$	—	0.18	0.35	
		$V_{OUT} = 3.3\text{V}$	—	0.16	0.35	
Thermal Resistance Junction to Ambient (θ_{JA})	X2-DFN1010-4 (Type B)	—	237	—	$^\circ\text{C}/\text{W}$	
	SOT25	—	179	—		
EN Input Low Voltage	—	—	—	0.4	V	
EN Input High Voltage	—	1.0	—	5.5	V	
Active Output Discharge Resistance	$V_{IN} = 4.0\text{V}$, $V_{EN} = 0\text{V}$	—	35	—	Ω	
Thermal Shutdown Threshold (TSHDN)	—	—	+160	—	$^\circ\text{C}$	
Thermal Shutdown Hysteresis (THYS)	—	—	+20	—	$^\circ\text{C}$	

- Notes:
- Short circuit current is measured with V_{OUT} pulled to GND.
 - Quiescent current defined here is the difference in current between the input and the output.
 - Dropout voltage is the voltage difference between the input and the output at which the output voltage drops 2% below its nominal value.

Typical Performance Characteristics (@ $T_A = +25^\circ\text{C}$, $C_{IN} = C_{OUT} = 0.1\mu\text{F}$)

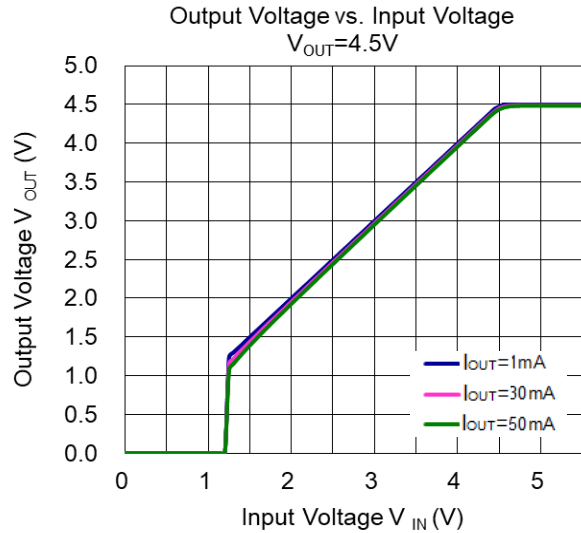
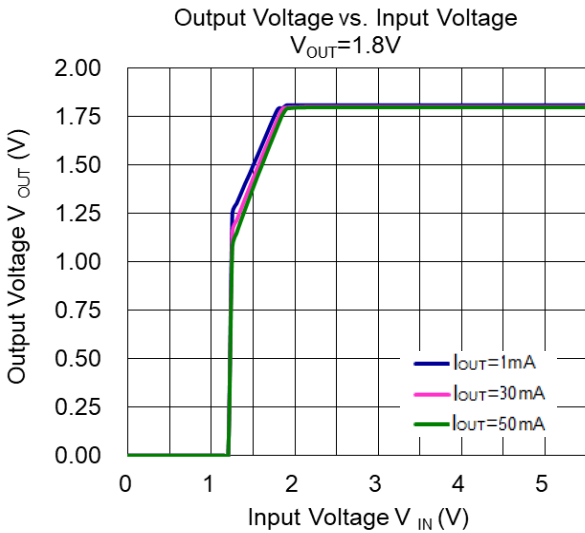
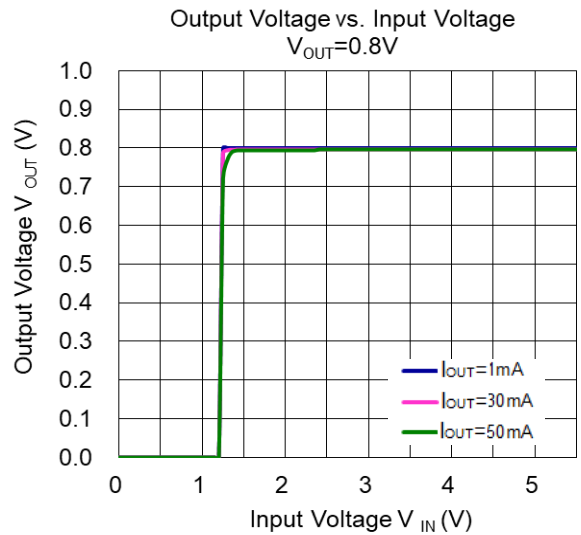
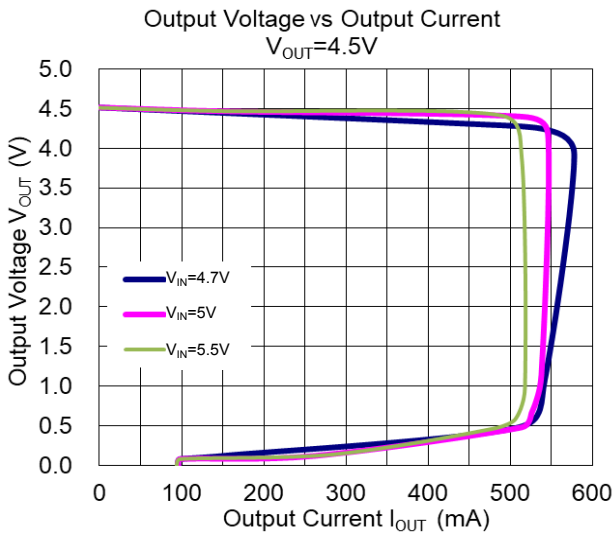
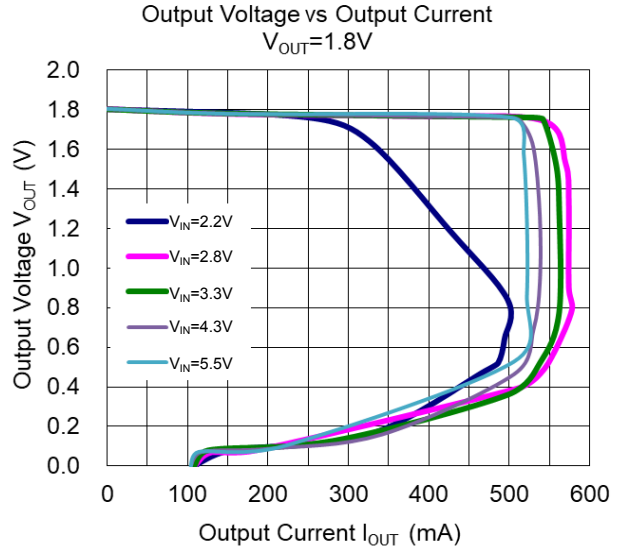
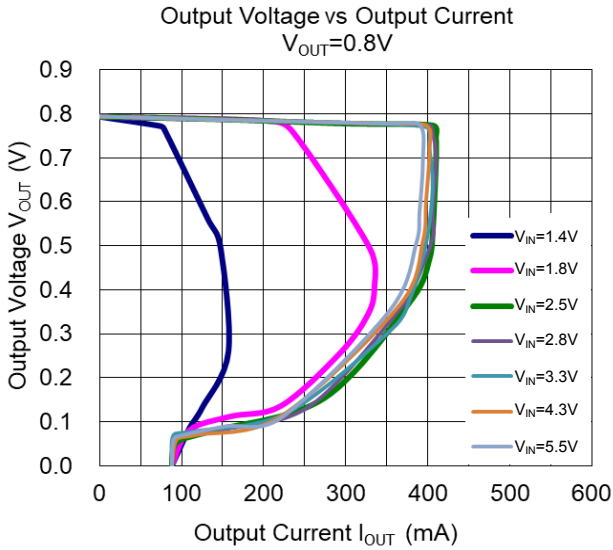

Typical Performance Characteristics (continued) (@ $T_A = +25^\circ\text{C}$, $C_{IN} = C_{OUT} = 0.1\mu\text{F}$)

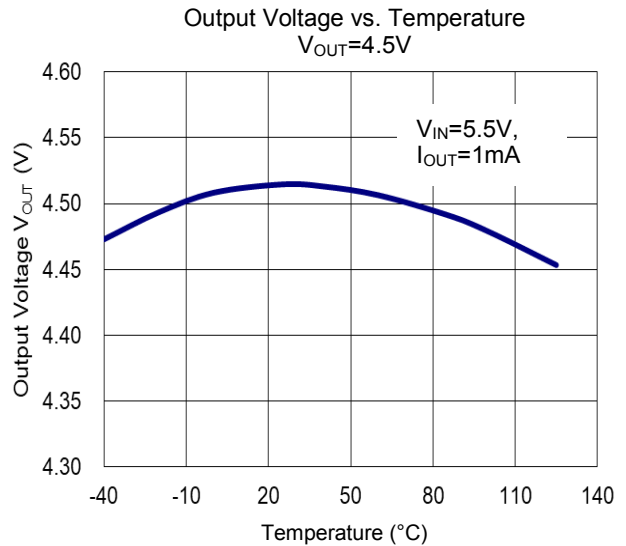
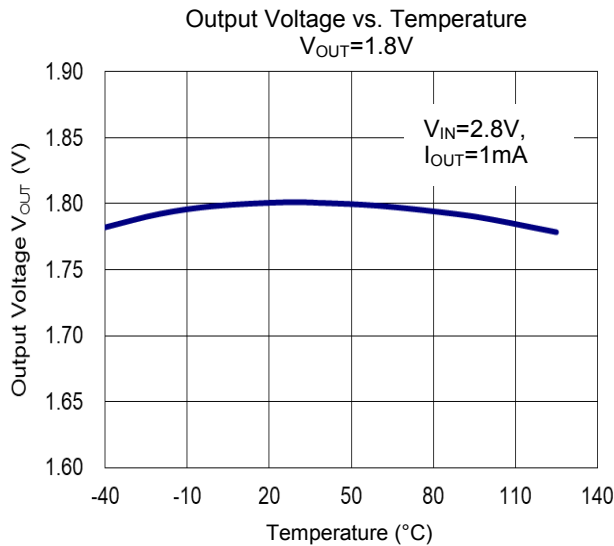
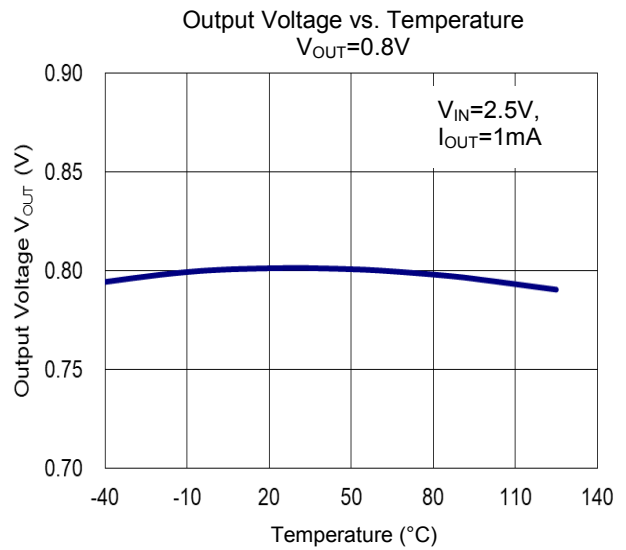
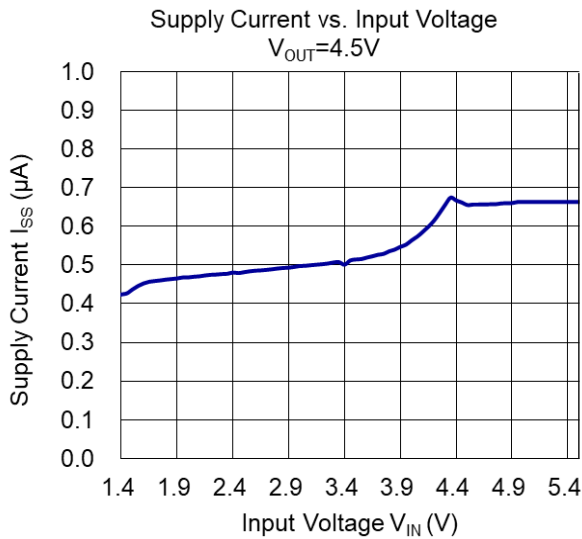
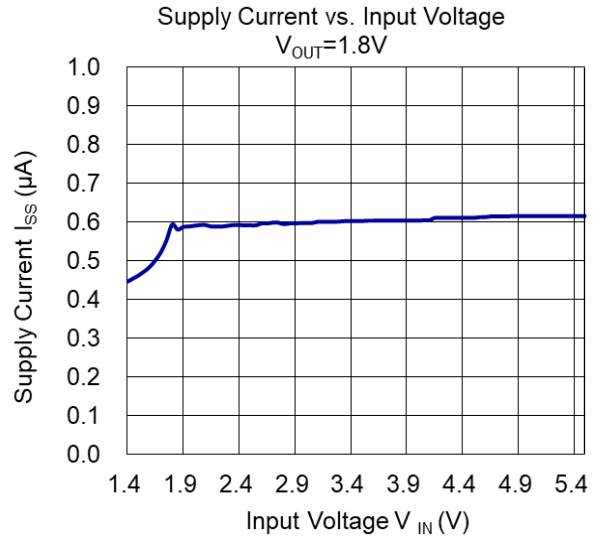
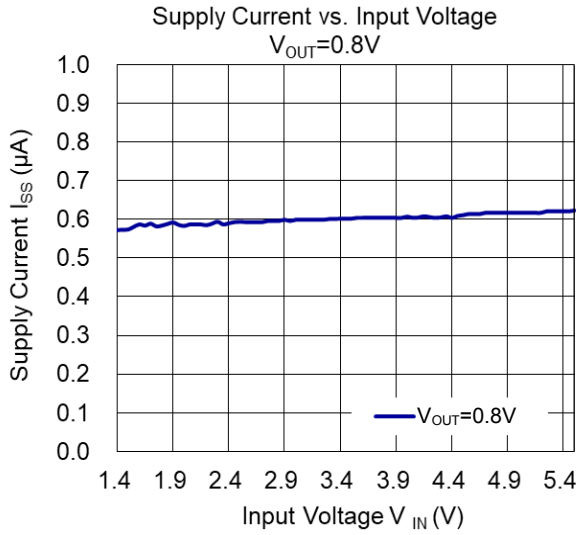

Typical Performance Characteristics (continued) ($C_{IN} = C_{OUT} = 0.1\mu F$)

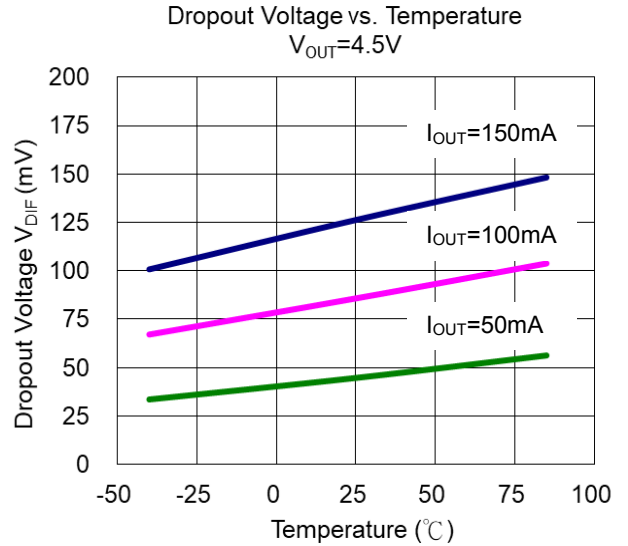
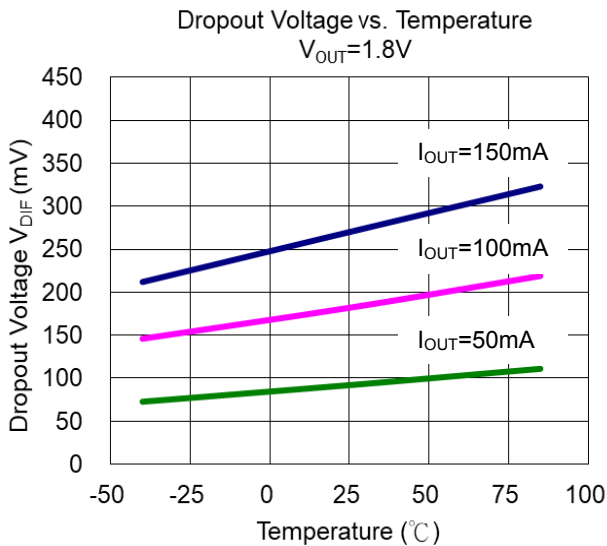
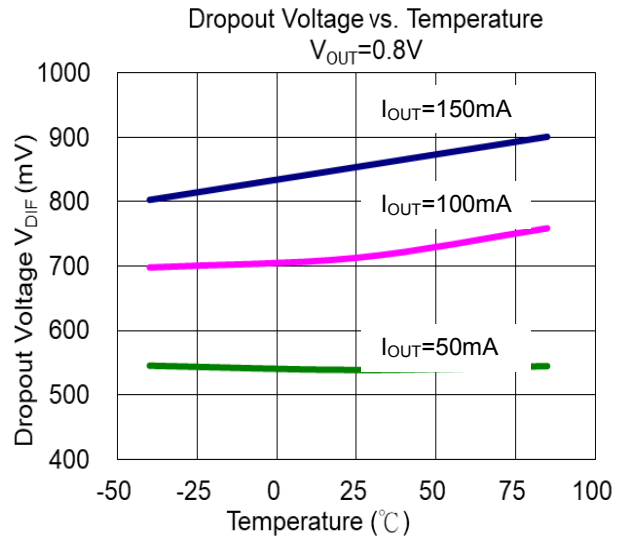
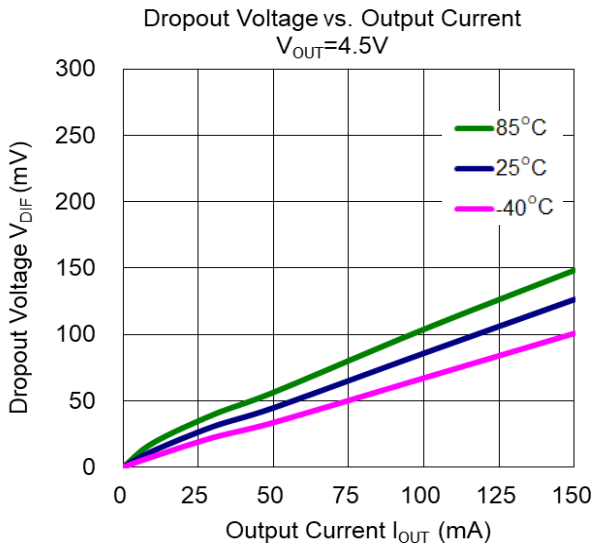
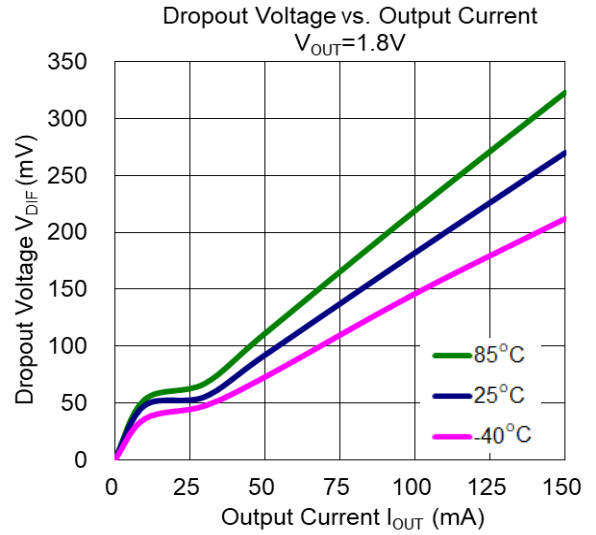
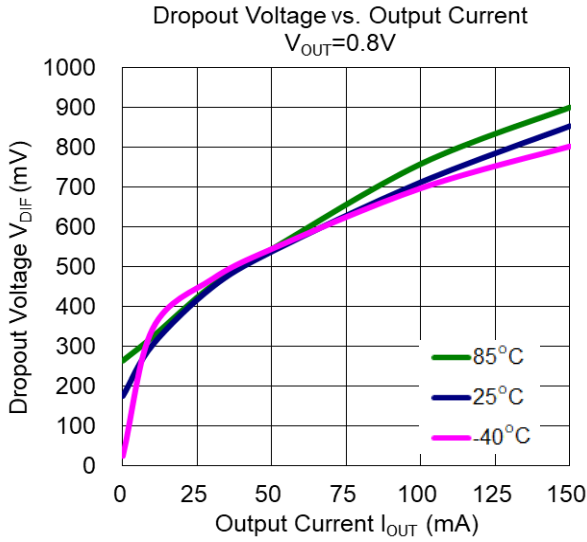

Typical Performance Characteristics (continued) (@ $T_A = +25^\circ\text{C}$, $C_{IN} = C_{OUT} = 0.1\mu\text{F}$)

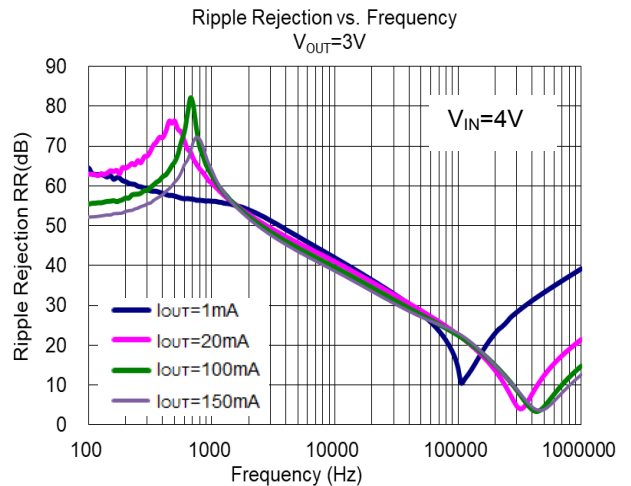
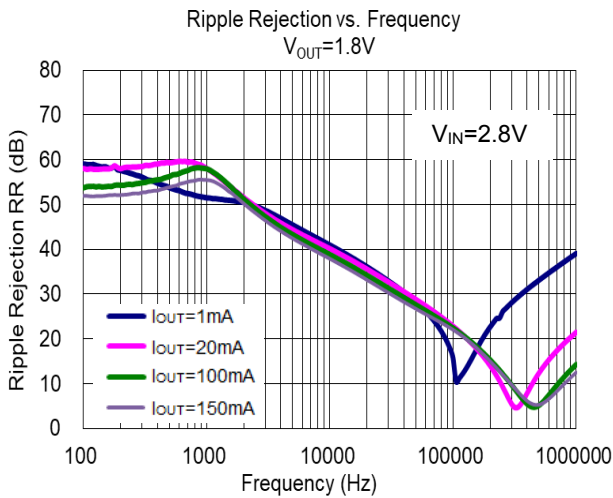
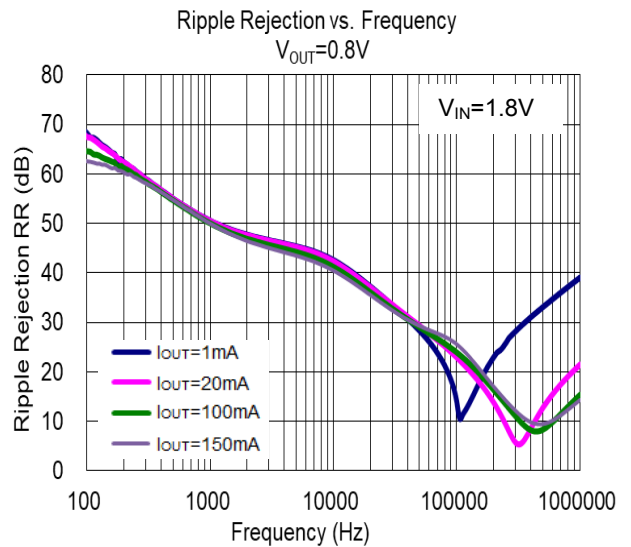
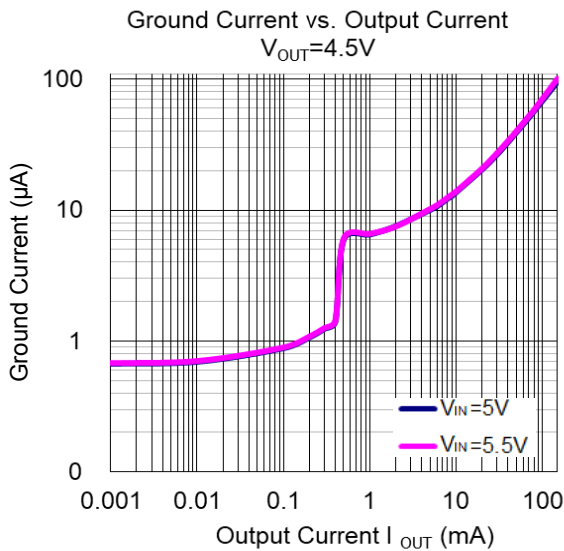
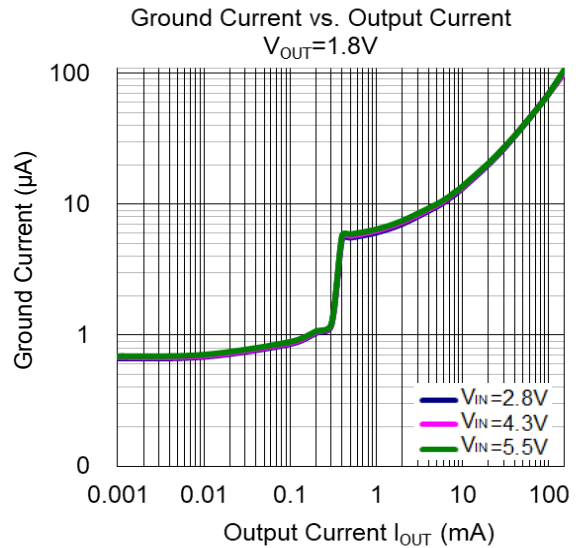
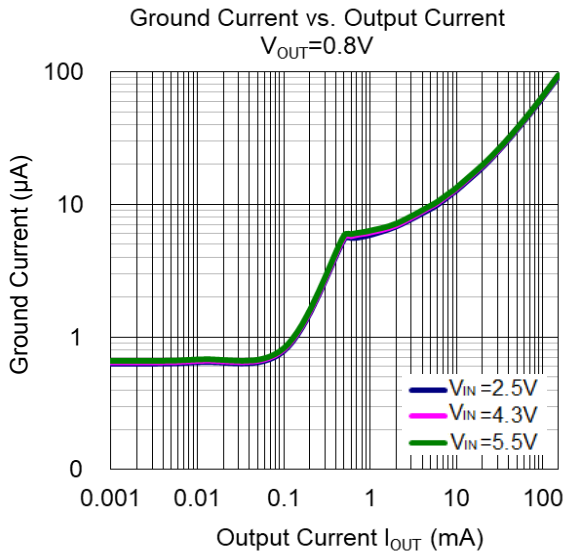

Typical Performance Characteristics (continued) (@ $T_A = +25^\circ\text{C}$, $C_{IN} = C_{OUT} = 0.1\mu\text{F}$)

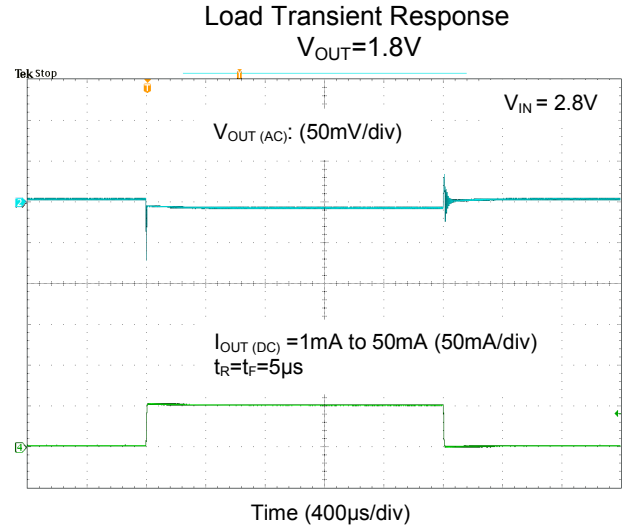
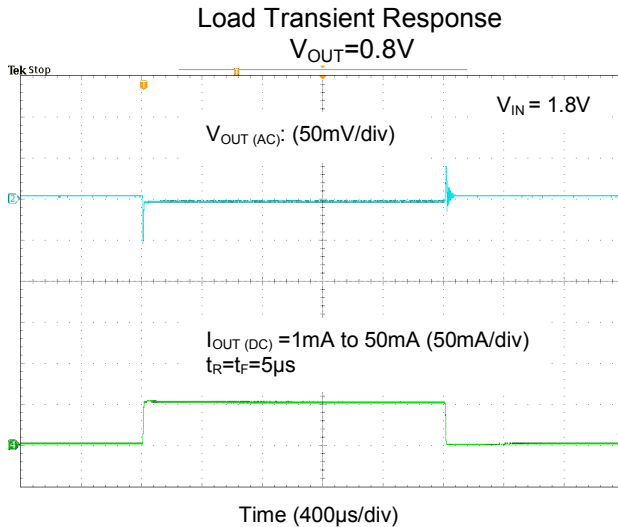
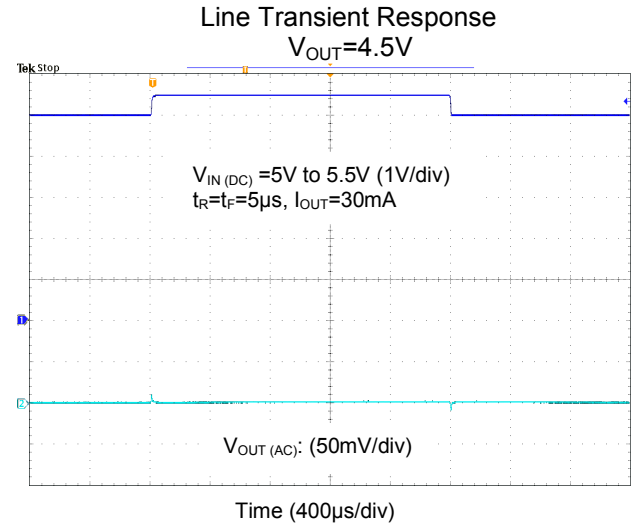
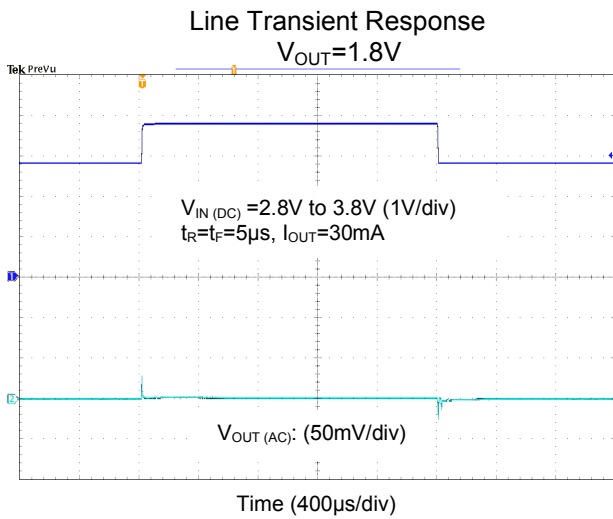
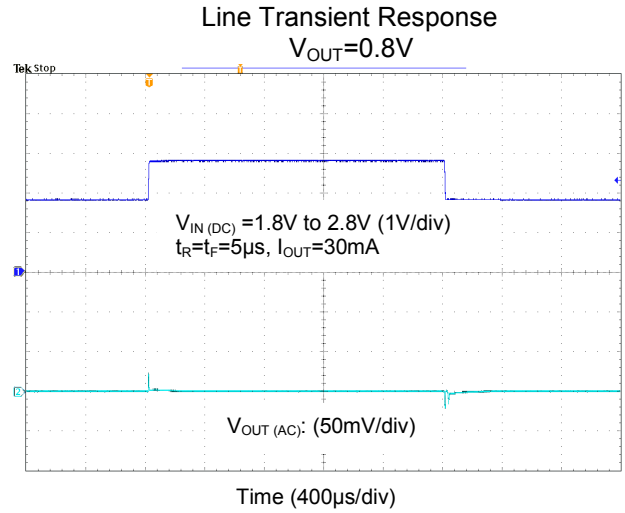
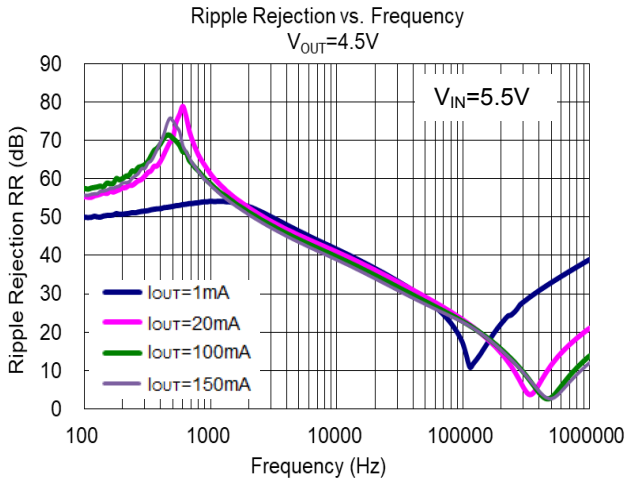

Typical Performance Characteristics (continued) (@ $T_A = +25^\circ\text{C}$, $C_{IN} = C_{OUT} = 0.1\mu\text{F}$)

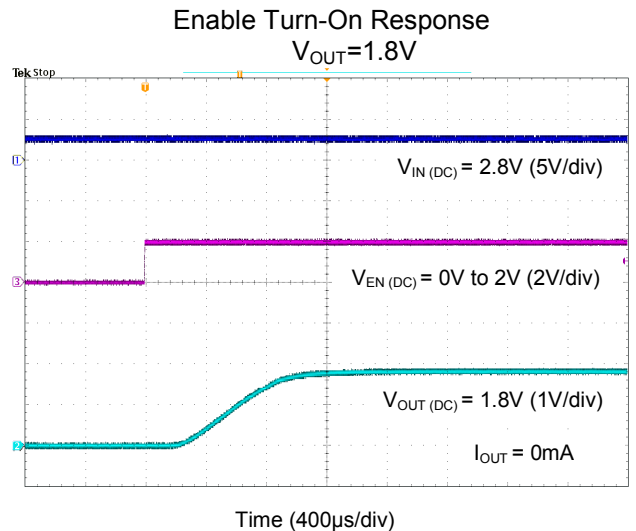
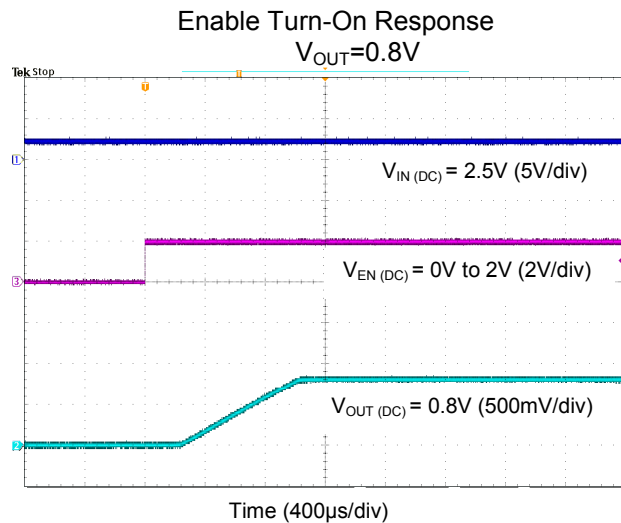
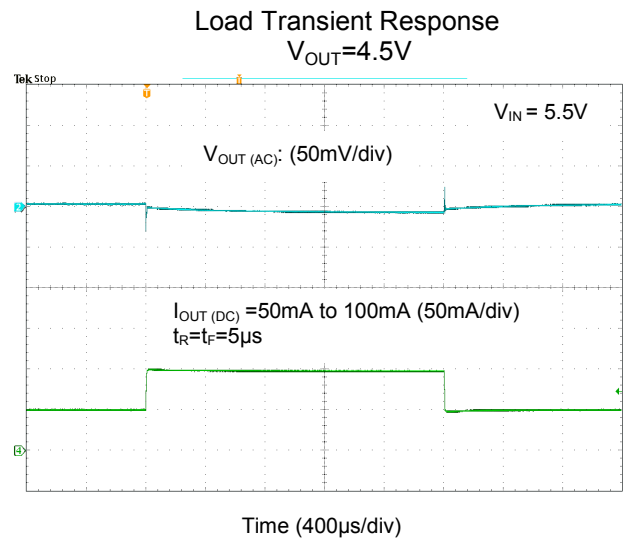
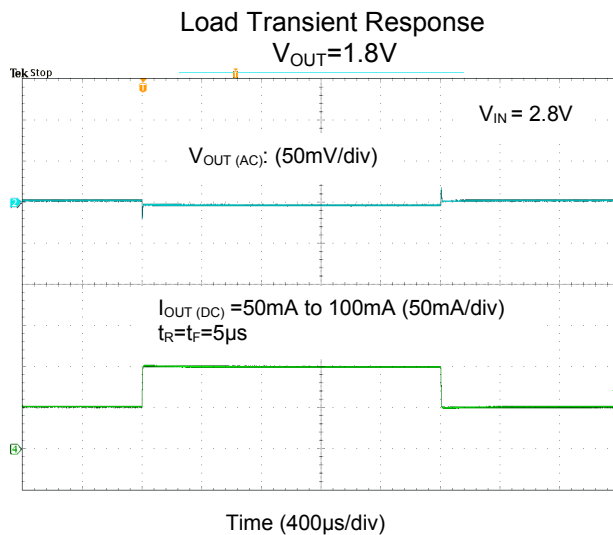
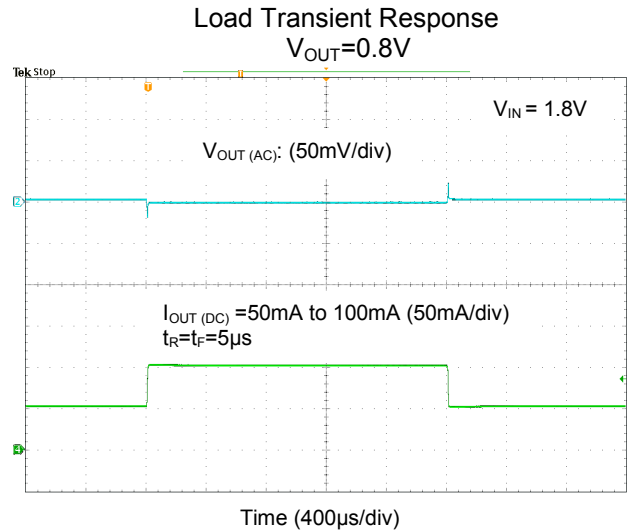
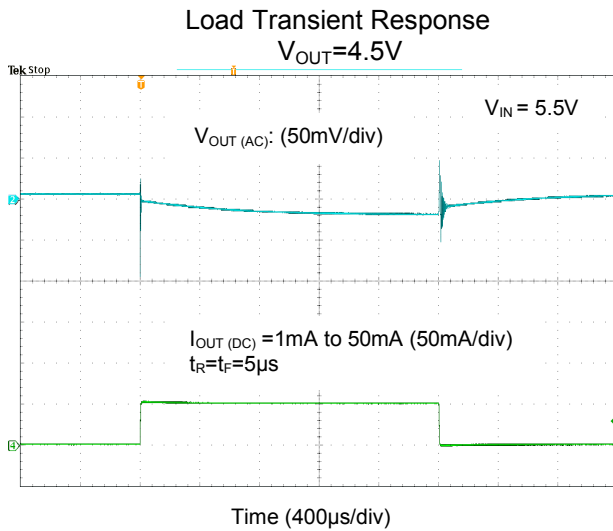

Typical Performance Characteristics (continued) (@ $T_A = +25^\circ\text{C}$, $C_{IN} = C_{OUT} = 0.1\mu\text{F}$)

Enable Turn-On Response
 $V_{OUT}=4.5\text{V}$

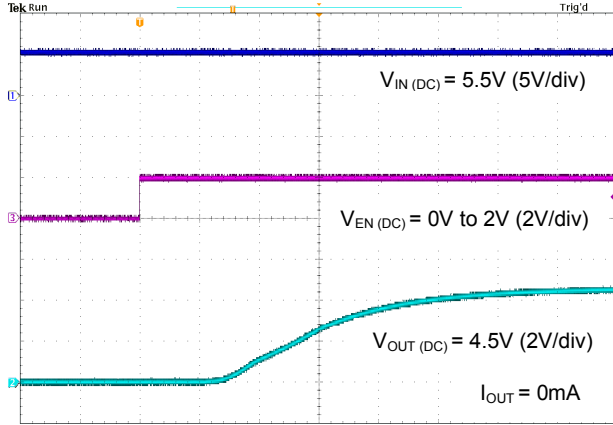

Time (400µs/div)

Enable Turn-On Response
 $V_{OUT}=0.8\text{V}$

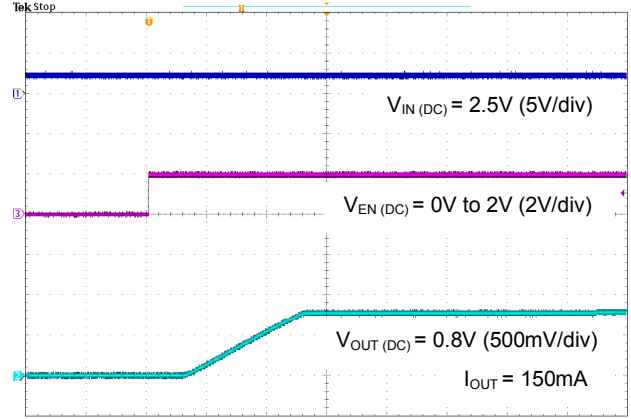

Time (400µs/div)

Enable Turn-On Response
 $V_{OUT}=1.8\text{V}$

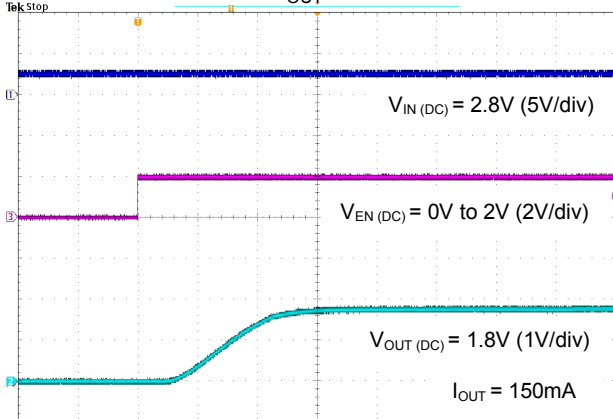

Time (400µs/div)

Enable Turn-On Response
 $V_{OUT}=4.5\text{V}$

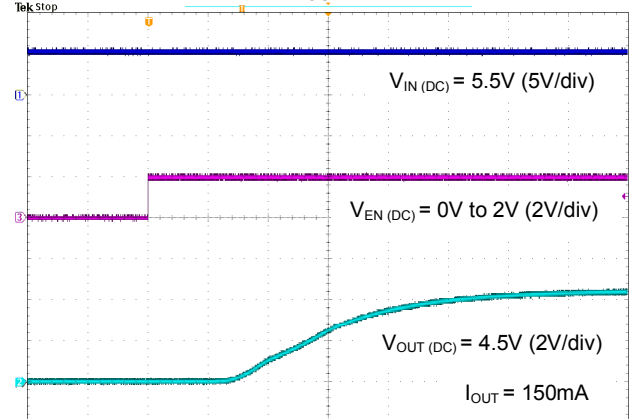

Time (400µs/div)

Enable Turn-Off Response
 $V_{OUT}=0.8\text{V}$

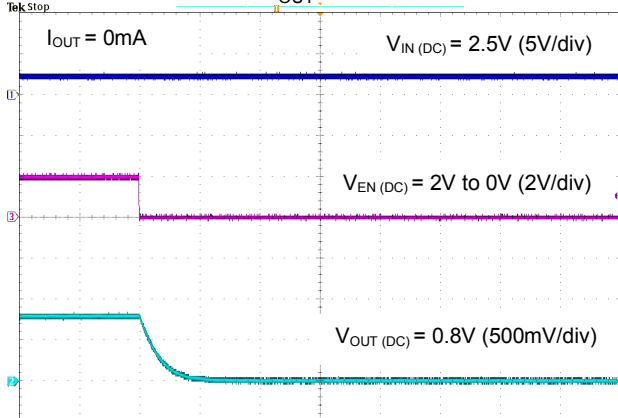

Time (400µs/div)

Enable Turn-Off Response
 $V_{OUT}=1.8\text{V}$

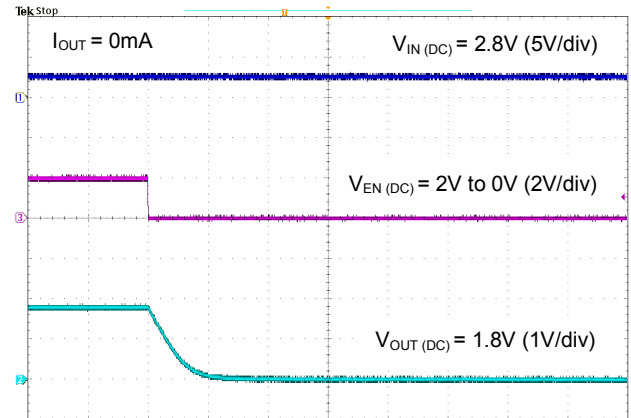

Time (400µs/div)

Typical Performance Characteristics (continued) (@ $T_A = +25^\circ\text{C}$, $C_{IN} = C_{OUT} = 0.1\mu\text{F}$)

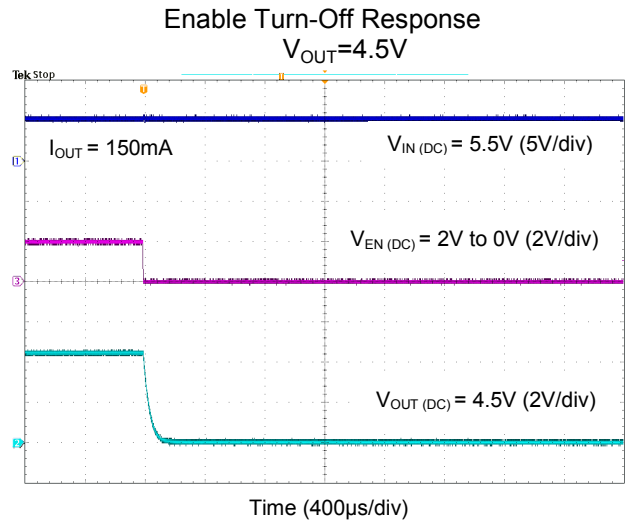
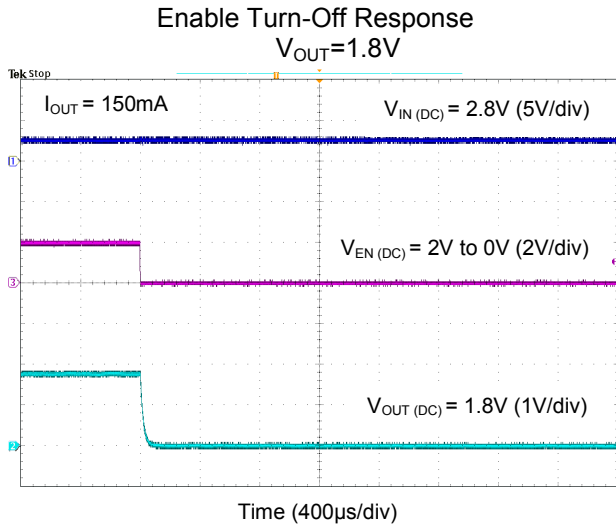
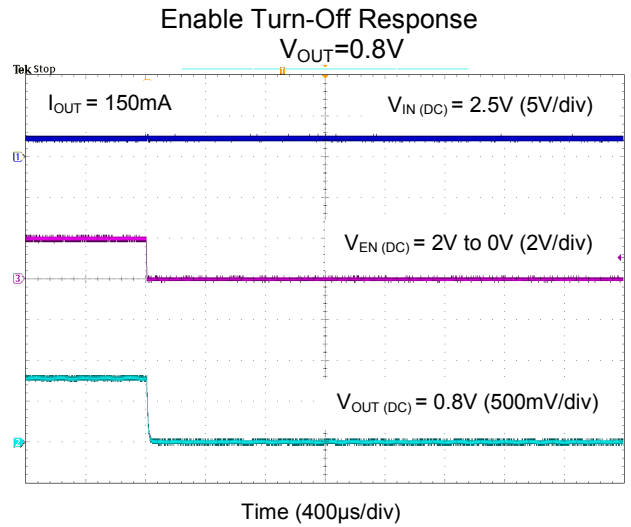
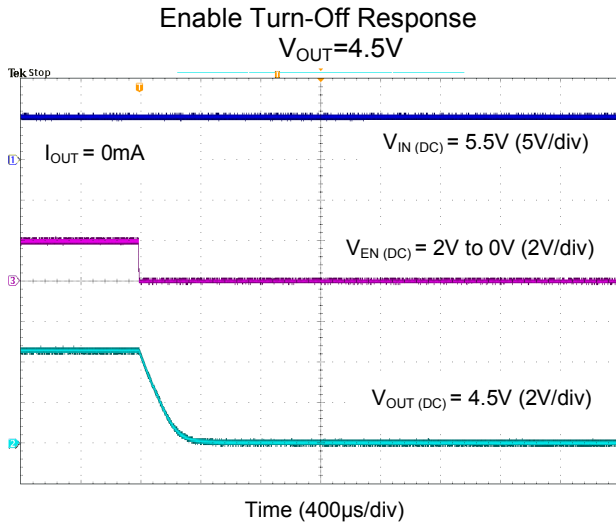

Application Information

Output Capacitor

An output capacitor (C_{OUT}) is needed to improve transient response and maintain stability. The AP7351D is stable with very small ceramic output capacitors. The ESR (Equivalent Series Resistance) and capacitance drive the selection. If the application has large load variations, it is recommended to utilize low-ESR bulk capacitors. It is recommended to place ceramic capacitors as close as possible to the load and the GND pin and care should be taken to reduce the impedance in the layout.

Input Capacitor

To prevent the input voltage from dropping during load steps, it is recommended to utilize an input capacitor (C_{IN}). A minimum 0.1 μ F ceramic capacitor is recommended between V_{IN} and GND pins to decouple input power supply glitch. This input capacitor must be located as close as possible to the device to assure input stability and reduce noise. For PCB layout, a wide copper trace is required for both V_{IN} and GND pins.

Enable Control

The AP7351D is turned on by setting the EN pin high, and is turned off by pulling them low. If this feature is not used, the EN pin should be tied to V_{IN} pin to keep the regulator output on at all time. To ensure proper operation, the signal source used to drive the EN pin must be able to swing above and below the specified turn-on/off voltage thresholds listed in the *Electrical Characteristics* section.

Layout Considerations

For good ground loop and stability, the input and output capacitors should be located close to the input, output, and GND pin of the device. The regulator GND pin should be connected to the external circuit ground to reduce voltage drop caused by trace impedance. Ground plane is generally used to reduce trace impedance. Wide trace should be used for large current paths from V_{IN} to V_{OUT} , and load circuit.

ESR vs. Output Current

A ceramic type output capacitor is recommended for this series; however, the other output capacitors with low ESR also can be used. The relations between I_{OUT} (Output Current) and ESR of an output capacitor are shown below. The stable region is marked as the hatched area in the graph. Measurement conditions: Frequency Band: 10Hz to 2MHz, Temperature: -40°C to $+85^{\circ}\text{C}$.

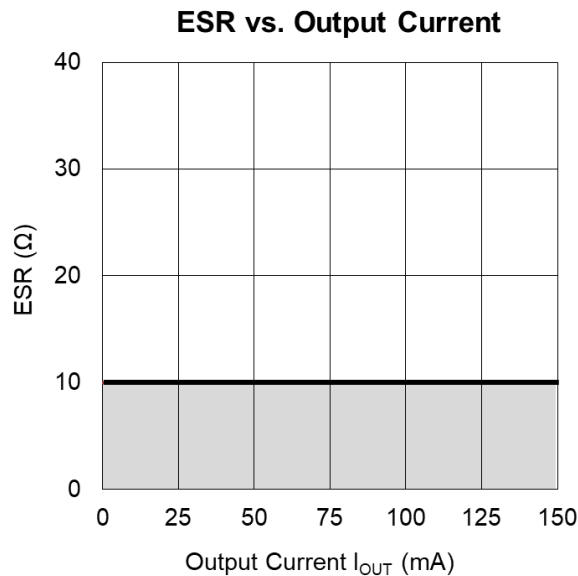

Ordering Information

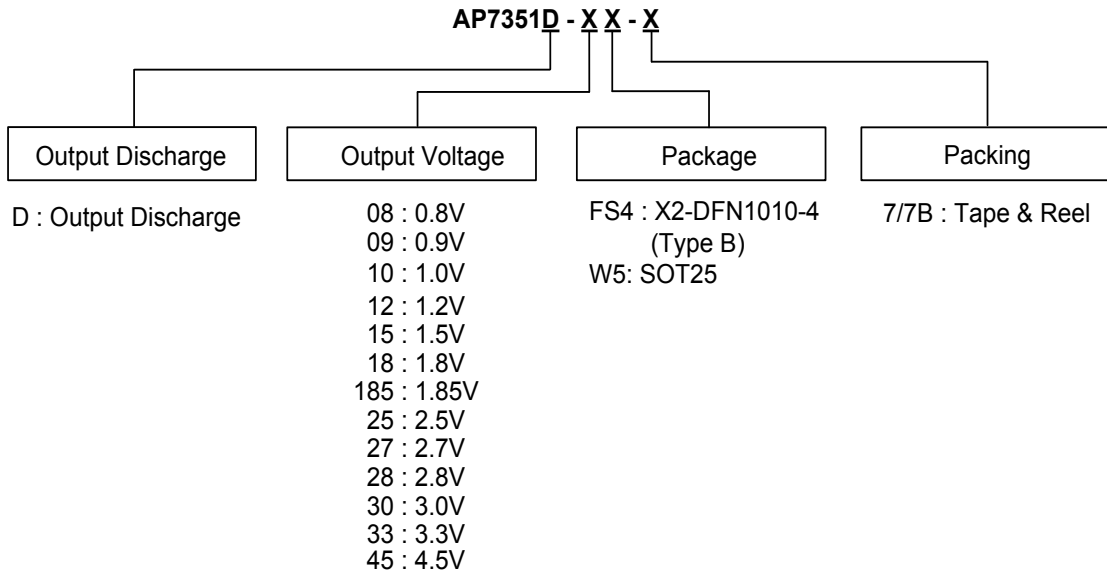

Part Number	Package Code	Packaging	7" Tape and Reel	
			Quantity	Part Number Suffix
AP7351D-XXFS4-7B	FS4	X2-DFN1010-4 (Type B)	10,000/Tape & Reel	-7B
AP7351D-XXXFS4-7B	FS4	X2-DFN1010-4 (Type B)	10,000/Tape & Reel	-7B
AP7351D-XXW5-7	W5	SOT25	3,000/Tape & Reel	-7
AP7351D-XXXW5-7	W5	SOT25	3,000/Tape & Reel	-7

Marking Information

(1) SOT25

(Top View)

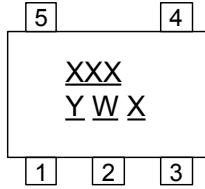

XXX : Identification Code
 Y : Year 0 to 9
 W : Week : A to Z : 1 to 26 week;
 a to z : 27 to 52 week; z represents
 52 and 53 week
 X : Internal Code

Part Number	Package Type	Identification Code
AP7351D-08W5-7 (Note 9)	SOT25	C7A
AP7351D-09W5-7 (Note 9)	SOT25	C7N
AP7351D-10W5-7 (Note 9)	SOT25	C7P
AP7351D-12W5-7 (Note 9)	SOT25	C7B
AP7351D-15W5-7	SOT25	C7C
AP7351D-18W5-7	SOT25	C7D
AP7351D-185W5-7 (Note 9)	SOT25	C7E
AP7351D-25W5-7	SOT25	C7F
AP7351D-27W5-7 (Note 9)	SOT25	C7G
AP7351D-28W5-7	SOT25	C7H
AP7351D-30W5-7 (Note 9)	SOT25	C7J
AP7351D-33W5-7	SOT25	C7K
AP7351D-45W5-7 (Note 9)	SOT25	C7M

Note: 9. This voltage is supported upon request.

Marking Information (continued)

(2) X2-DFN1010-4 (Type B)

(Top View)

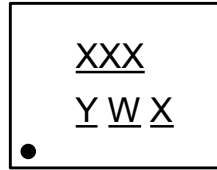

XXX : Identification Code

Y : Year : 0~9

W : Week : A~Z : 1~26 week;
a~z : 27~52 week; z represents
52 and 53 week

X : Internal Code

Part Number	Package	Identification Code
AP7351D-08FS4-7B (Note 9)	X2-DFN1010-4 (Type B)	C7A
AP7351D-09FS4-7B (Note 9)	X2-DFN1010-4 (Type B)	C7N
AP7351D-10FS4-7B (Note 9)	X2-DFN1010-4 (Type B)	C7P
AP7351D-12FS4-7B (Note 9)	X2-DFN1010-4 (Type B)	C7B
AP7351D-15FS4-7B	X2-DFN1010-4 (Type B)	C7C
AP7351D-18FS4-7B	X2-DFN1010-4 (Type B)	C7D
AP7351D-185FS4-7B (Note 9)	X2-DFN1010-4 (Type B)	C7E
AP7351D-25FS4-7B	X2-DFN1010-4 (Type B)	C7F
AP7351D-27FS4-7B (Note 9)	X2-DFN1010-4 (Type B)	C7G
AP7351D-28FS4-7B	X2-DFN1010-4 (Type B)	C7H
AP7351D-30FS4-7B (Note 9)	X2-DFN1010-4 (Type B)	C7J
AP7351D-33FS4-7B	X2-DFN1010-4 (Type B)	C7K
AP7351D-45FS4-7B (Note 9)	X2-DFN1010-4 (Type B)	C7M

Note: 9. This voltage is supported upon request.

Package Outline Dimensions

Please see <http://www.diodes.com/package-outlines.html> for the latest version.

(1) Package Type: X2-DFN1010-4 (Type B)

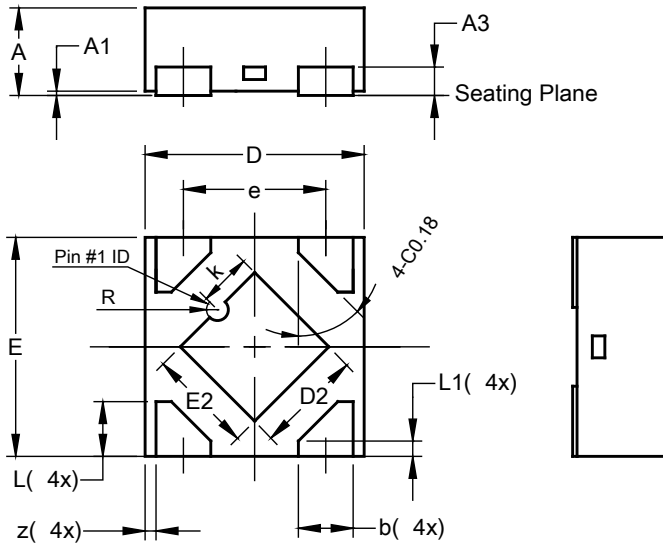

X2-DFN1010-4 (Type B)			
Dim	Min	Max	Typ
A	-	0.40	0.39
A1	0.00	0.05	0.02
A3	-	-	0.13
b	0.20	0.30	0.25
D	0.95	1.05	1.00
D2	0.43	0.53	0.48
E	0.95	1.05	1.00
E2	0.43	0.53	0.48
e	-	-	0.65
k	0.19	0.29	0.24
L	0.20	0.30	0.25
L1	0.02	0.12	0.07
R	0.02	0.08	0.05
z	-	-	0.050
All Dimensions in mm			

(2) Package Type: SOT25

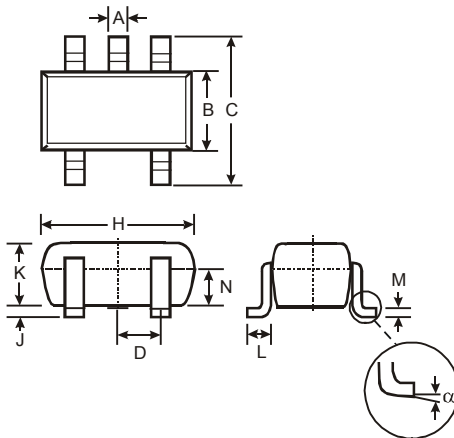

SOT25			
Dim	Min	Max	Typ
A	0.35	0.50	0.38
B	1.50	1.70	1.60
C	2.70	3.00	2.80
D	-	-	0.95
H	2.90	3.10	3.00
J	0.013	0.10	0.05
K	1.00	1.30	1.10
L	0.35	0.55	0.40
M	0.10	0.20	0.15
N	0.70	0.80	0.75
α	0°	8°	-
All Dimensions in mm			

Suggested Pad Layout

Please see <http://www.diodes.com/package-outlines.html> for the latest version.

(1) Package Type: X2-DFN1010-4 (Type B)

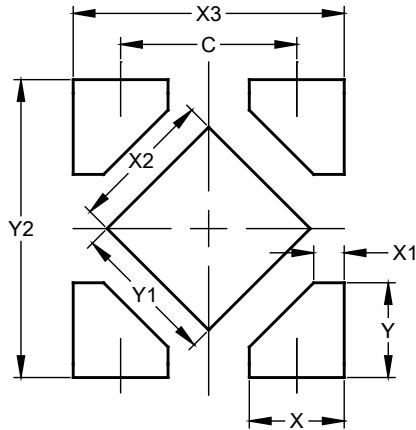

Dimensions	Value (in mm)
C	0.650
X	0.350
X1	0.112
X2	0.530
X3	1.00
Y	0.350
Y1	0.530
Y2	1.100

(2) Package Type: SOT25

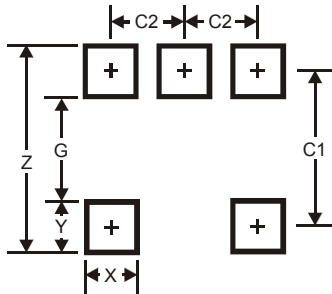

Dimensions	Value
Z	3.20
G	1.60
X	0.55
Y	0.80
C1	2.40
C2	0.95

IMPORTANT NOTICE

1. DIODES INCORPORATED AND ITS SUBSIDIARIES ("DIODES") MAKE NO WARRANTY OF ANY KIND, EXPRESS OR IMPLIED, WITH REGARDS TO ANY INFORMATION CONTAINED IN THIS DOCUMENT, INCLUDING, BUT NOT LIMITED TO, THE IMPLIED WARRANTIES OF MERCHANTABILITY, FITNESS FOR A PARTICULAR PURPOSE OR NON-INFRINGEMENT OF THIRD PARTY INTELLECTUAL PROPERTY RIGHTS (AND THEIR EQUIVALENTS UNDER THE LAWS OF ANY JURISDICTION).
2. The Information contained herein is for informational purpose only and is provided only to illustrate the operation of Diodes products described herein and application examples. Diodes does not assume any liability arising out of the application or use of this document or any product described herein. This document is intended for skilled and technically trained engineering customers and users who design with Diodes products. Diodes products may be used to facilitate safety-related applications; however, in all instances customers and users are responsible for (a) selecting the appropriate Diodes products for their applications, (b) evaluating the suitability of the Diodes products for their intended applications, (c) ensuring their applications, which incorporate Diodes products, comply the applicable legal and regulatory requirements as well as safety and functional-safety related standards, and (d) ensuring they design with appropriate safeguards (including testing, validation, quality control techniques, redundancy, malfunction prevention, and appropriate treatment for aging degradation) to minimize the risks associated with their applications.
3. Diodes assumes no liability for any application-related information, support, assistance or feedback that may be provided by Diodes from time to time. Any customer or user of this document or products described herein will assume all risks and liabilities associated with such use, and will hold Diodes and all companies whose products are represented herein or on Diodes' websites, harmless against all damages and liabilities.
4. Products described herein may be covered by one or more United States, international or foreign patents and pending patent applications. Product names and markings noted herein may also be covered by one or more United States, international or foreign trademarks and trademark applications. Diodes does not convey any license under any of its intellectual property rights or the rights of any third parties (including third parties whose products and services may be described in this document or on Diodes' website) under this document.
5. Diodes products are provided subject to Diodes' Standard Terms and Conditions of Sale (<https://www.diodes.com/about/company/terms-and-conditions/terms-and-conditions-of-sales/>) or other applicable terms. This document does not alter or expand the applicable warranties provided by Diodes. Diodes does not warrant or accept any liability whatsoever in respect of any products purchased through unauthorized sales channel.
6. Diodes products and technology may not be used for or incorporated into any products or systems whose manufacture, use or sale is prohibited under any applicable laws and regulations. Should customers or users use Diodes products in contravention of any applicable laws or regulations, or for any unintended or unauthorized application, customers and users will (a) be solely responsible for any damages, losses or penalties arising in connection therewith or as a result thereof, and (b) indemnify and hold Diodes and its representatives and agents harmless against any and all claims, damages, expenses, and attorney fees arising out of, directly or indirectly, any claim relating to any noncompliance with the applicable laws and regulations, as well as any unintended or unauthorized application.
7. While efforts have been made to ensure the information contained in this document is accurate, complete and current, it may contain technical inaccuracies, omissions and typographical errors. Diodes does not warrant that information contained in this document is error-free and Diodes is under no obligation to update or otherwise correct this information. Notwithstanding the foregoing, Diodes reserves the right to make modifications, enhancements, improvements, corrections or other changes without further notice to this document and any product described herein. This document is written in English but may be translated into multiple languages for reference. Only the English version of this document is the final and determinative format released by Diodes.
8. Any unauthorized copying, modification, distribution, transmission, display or other use of this document (or any portion hereof) is prohibited. Diodes assumes no responsibility for any losses incurred by the customers or users or any third parties arising from any such unauthorized use.

Copyright © 2020 Diodes Incorporated

www.diodes.com

Looking for pricing, stock, or lifecycle information?

Click below to explore more details on WIN SOURCE:

- ⊖ [View AP7351D-30W5-7 on WIN SOURCE](#)
- ⊖ [Diodes Incorporated Information](#)

Optimize Your Supply Chain with WIN SOURCE Solutions

- ✓ Global Sourcing Solution
- ✓ Obsolete Management
- ✓ Cost Control Management
- ✓ Shortage Management
- ✓ Alternative Solution
- ✓ Excess Inventory Management