



**THE DATASHEET OF
ISL80410IBEZ**



ISL80410

40V, Low Quiescent Current, High Accuracy, 150mA Linear Regulator

The [ISL80410](#) is a high voltage, adjustable V_{OUT} , low quiescent current linear regulator ideally suited for “always-on” and “keep alive” applications. The ISL80410 operates from an input voltage of +6V to +40V under normal operating conditions and consumes only 18 μ A of quiescent current at no load.

The ISL80410 features an EN pin that can be used to put the device into a low-quiescent current shutdown mode in which it draws only 2 μ A of supply current. The device features over-temperature shutdown and current limit protection.

The ISL80410 is rated to operate across the -40°C to +125°C temperature range and is available in an 8 Ld Small Outline Exposed Pad Plastic Package (EPSOIC).

Applications

- Industrial
- Telecommunications

Features

- Wide V_{IN} range of 6V to 40V
- Adjustable output voltage from 2.5V to 12V
- Ensured 150mA output current
- Ultra low 18 μ A typical quiescent current
- Low 2 μ A of typical shutdown current
- $\pm 1\%$ accurate voltage reference (over temperature, load)
- Low dropout voltage of 295mV at 150mA
- Low 26 μ V_{RMS} noise
- 40V tolerant logic level (TTL/CMOS) enable input
- Stable operation with 10 μ F output capacitor
- 5kV ESD HBM rated
- Thermal shutdown and current limit protection
- 8 Ld exposed pad EPSOIC package

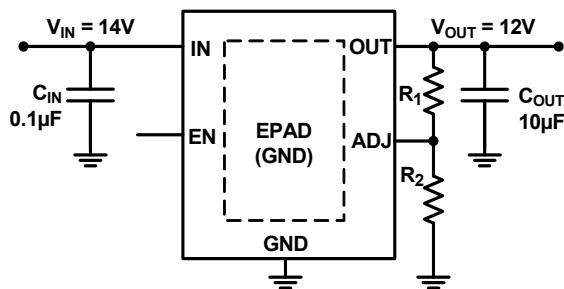

Figure 1. Typical Application

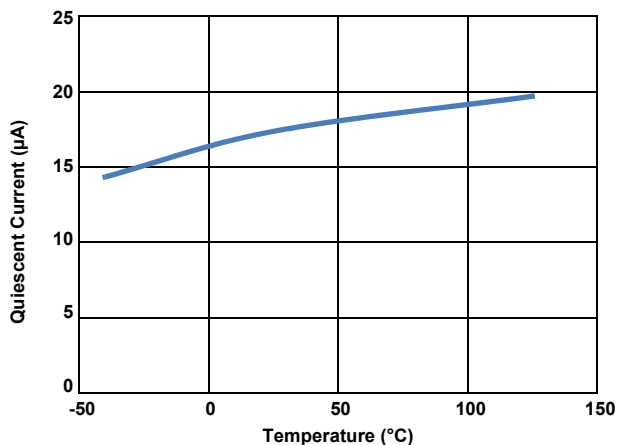

Figure 2. Quiescent Current vs Temperature (at Unity Gain), $V_{IN} = 14V$

1. Overview

1.1 Block Diagram

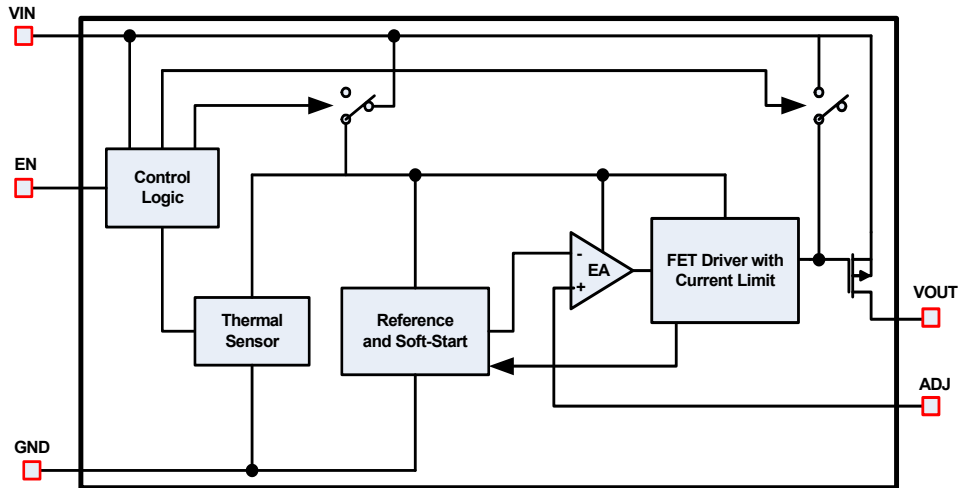

Figure 3. Block Diagram

1.2 Ordering Information

| Part Number (Notes 2, 3) | Part Marking | Enable Pin | Output Voltage (V) | Package (RoHS Compliant) | Pkg. Dwg. # | Carrier Type (Note 1) | Temp. Range (°C) |
|-----------------------------|---------------------|------------|--------------------|--------------------------|-------------|--------------------------|------------------|
| ISL80410IBEZ | 80410 | Yes | ADJ | 8 Ld EPSON | M8.15B | Tube | -40 to +125 |
| ISL80410IBEZ-T | IBEZ | | | | | Reel, 2.5k | |
| ISL80410IBEZ-T7A | | | | | | Reel, 250 | |
| ISL80410EVAL1Z | Evaluation Platform | | | | | | |

Notes:

- See [TB347](#) for details about reel specifications.
- These Pb-free plastic packaged products employ special Pb-free material sets, molding compounds/die attach materials, and 100% matte tin plate plus anneal (e3 termination finish, which is RoHS compliant and compatible with both SnPb and Pb-free soldering operations). Pb-free products are MSL classified at Pb-free peak reflow temperatures that meet or exceed the Pb-free requirements of IPC/JEDEC J STD-020.
- For Moisture Sensitivity Level (MSL), see the [ISL80410](#) device page. For more information about MSL, see [TB363](#).

Table 1. Key Differences in Family of 40V LDO Parts

| Part Number | Minimum I_{OUT} | IC Package |
|-------------|-------------------|--------------|
| ISL80410 | 150mA | 8 Ld EPSON |
| ISL80136 | 50mA | 8 Ld EPSON |
| ISL80138 | 150mA | 14 LD HTSSOP |

1.3 Pin Configuration

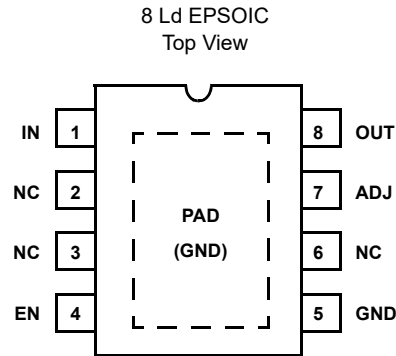

1.4 Pin Descriptions

| Pin Number | Pin Name | Description |
|------------|----------|---|
| 1 | IN | Input voltage pin. A minimum 0.1µF X5R/X7R capacitor is required for proper operation. Range: 6V to 40V |
| 2, 3, 6 | NC | These pins have internal termination and can be left unconnected. Connection to ground is optional. |
| 4 | EN | Set this pin high to enable the device. Range: 0V to V_{IN} |
| 5 | GND | Ground pin. |
| 7 | ADJ | This pin is connected to the external feedback resistor divider, which sets the LDO output voltage. |
| 8 | OUT | Regulated output voltage. A 10µF X5R/X7R output capacitor is required for stability. Range: 0V to 12V |
| - | PAD | It is recommended to solder the PAD to the ground plane. |

2. Specifications

2.1 Absolute Maximum Ratings

| Parameter | Minimum | Maximum | Unit |
|--|------------|---------|------|
| IN Pin to GND Voltage | GND - 0.3 | 45 | V |
| OUT Pin to GND Voltage | GND - 0.3 | 16 | V |
| ADJ Pin to GND Voltage | GND - 0.3 | 3 | V |
| EN Pin to GND Voltage | GND - 0.3 | VIN | V |
| Output Short-Circuit Duration | Indefinite | | - |
| ESD Rating | Value | | Unit |
| Human Body Model (Tested per JESD22-A114E) | | 5 | kV |
| Machine Model (Tested per JESD-A115-A) | | 200 | V |
| Charge Device Model (Tested per JESD22-C101C) | | 2.2 | kV |
| Latch-up (Tested per JESD78B; Class II, Level A) | | 100 | mA |

CAUTION: Do not operate at or near the maximum ratings listed for extended periods of time. Exposure to such conditions can adversely impact product reliability and result in failures not covered by warranty.

2.2 Thermal Information

| Thermal Resistance (Typical) | θ_{JA} (°C/W) | θ_{JC} (°C/W) |
|---|----------------------|----------------------|
| 8 Ld EPSON Package (Notes 4, 5) | 50 | 9 |

Notes:

- θ_{JA} is measured in free air with the component mounted on a high-effective thermal conductivity test board with "direct attach" features. See [TB379](#) for more information.
- For θ_{JC} , the "case temp" location is the center of the exposed metal pad on the package underside.

| Parameter | Minimum | Maximum | Unit |
|-----------------------------------|---------------------------|---------|------|
| Maximum Junction Temperature | | +150 | °C |
| Maximum Storage Temperature Range | -65 | +175 | °C |
| Pb-Free Reflow Profile | See TB493 | | |

2.3 Recommended Operating Conditions

| Parameter | Minimum | Maximum | Unit |
|---------------------------|---------|---------|------|
| Ambient Temperature Range | -40 | +125 | °C |
| IN pin to GND Voltage | +6 | +40 | V |
| OUT pin to GND Voltage | +2.5 | 12 | V |
| EN pin to GND Voltage | 0 | 40 | V |

2.4 Electrical Specifications

Recommended Operating Conditions, unless otherwise noted. $V_{IN} = 14V$, $I_{OUT} = 1mA$, $T_A = T_J = -40^{\circ}C$ to $+125^{\circ}C$, unless otherwise noted. Typical specifications are at $T_A = +25^{\circ}C$. **Boldface limits apply across the operating temperature range, $-40^{\circ}C$ to $+125^{\circ}C$.**

| Parameter | Symbol | Test Conditions | Min (Note 8) | Typ | Max (Note 8) | Unit |
|--------------------------------|---|---|-----------------|-------|-----------------|---------------|
| Input Voltage Range | V_{IN} | | 6 | | 40 | V |
| Guaranteed Output Current | I_{OUT} | $V_{IN} = V_{OUT} + V_{DO}$ | 150 | | | mA |
| ADJ Reference Voltage | V_{OUT} | EN = High, $V_{IN} = 14V$, $I_{OUT} = 0.1mA$ to $150mA$ | 1.211 | 1.223 | 1.235 | V |
| Line Regulation | $(V_{OUT\ low\ line} - V_{OUT\ high\ line}) / I_{OUT\ low\ line}$ | $6V < V_{IN} < 40V$, $I_{OUT} = 1mA$ | | 0.04 | 0.15 | % |
| Load Regulation | $(V_{OUT\ no\ load} - V_{OUT\ high\ load}) / I_{OUT\ no\ load}$ | $V_{IN} = 14V$, $I_{OUT} = 100\mu A$ to $150mA$ | | 0.3 | 0.6 | % |
| Dropout Voltage (Note 6) | ΔV_{DO} | $I_{OUT} = 1mA$, $V_{OUT} = 2.5V$ | | 7 | 33 | mV |
| | | $I_{OUT} = 150mA$, $V_{OUT} = 2.5V$ | | 380 | 610 | mV |
| | | $I_{OUT} = 1mA$, $V_{OUT} = 5V$ | | 7 | 33 | mV |
| | | $I_{OUT} = 150mA$, $V_{OUT} = 5V$ | | 295 | 545 | mV |
| Shutdown Current | I_{SHDN} | EN = LOW | | 2 | 3.64 | μA |
| Quiescent Current | IQ | EN = HIGH, $I_{OUT} = 0mA$ | | 18 | 24 | μA |
| | | EN = HIGH, $I_{OUT} = 1mA$ | | 22 | 42 | μA |
| | | EN = HIGH, $I_{OUT} = 10mA$ | | 34 | 60 | μA |
| | | EN = HIGH, $I_{OUT} = 150mA$ | | 90 | 125 | μA |
| Power Supply Rejection Ratio | PSRR | $f = 100Hz$; $V_{IN_RIPPLE} = 500mV_{P-P}$; Load = $150mA$ | | 66 | | dB |
| Output Voltage Noise | | $V_{IN} = 14V$, $V_{OUT} = 3.3V$, $C_{OUT} = 10\mu F$, $I_{OUT} = 10mA$, BW = $100Hz$ to $100kHz$ | | 26 | | μV_{RMS} |
| EN Function | | | | | | |
| EN Threshold Voltage | V_{EN_H} | $V_{OUT} = \text{Off to On}$ | | | 1.485 | V |
| | V_{EN_L} | $V_{OUT} = \text{On to Off}$ | 0.975 | | | V |
| EN Pin Current | I_{EN} | $V_{OUT} = 0V$ | | 0.026 | | μA |
| EN to Regulation Time (Note 7) | t_{EN} | | | 1.65 | 1.93 | ms |
| Protection Features | | | | | | |
| Output Current Limit | I_{LIMIT} | $V_{OUT} = 0V$ | 175 | 410 | | mA |
| Thermal Shutdown | T_{SHDN} | Junction Temperature Rising | | +165 | | $^{\circ}C$ |
| Thermal Shutdown Hysteresis | T_{HYST} | | | +20 | | $^{\circ}C$ |

Notes:

- Dropout voltage is defined as $(V_{IN} - V_{OUT})$ when V_{OUT} is 2% below the value of V_{OUT} .
- Enable to Regulation Time is the time the output takes to reach 95% of its final value with $V_{IN} = 14V$. EN is taken from V_{IL} to V_{IH} in 5ns. For the adjustable versions, the output voltage is set at 5V.
- Parameters with MIN and/or MAX limits are 100% tested at $+25^{\circ}C$, unless otherwise specified. Temperature limits established by characterization and are not production tested.

3. Typical Performance Curves

$V_{IN} = 14V$, $I_{OUT} = 1mA$, $V_{OUT} = 5V$, $T_J = +25^{\circ}C$, unless otherwise specified.

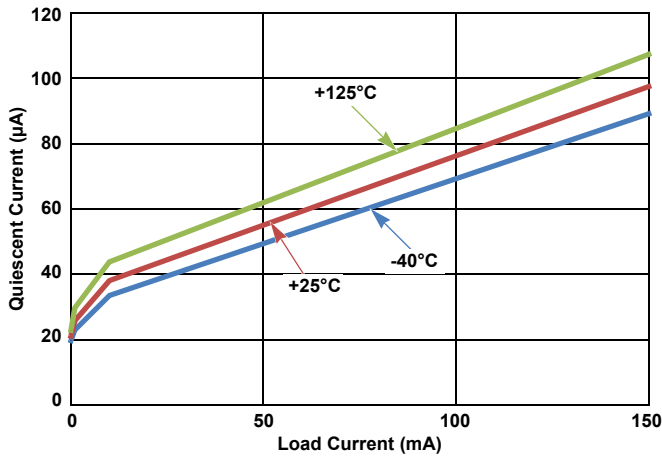

Figure 4. Quiescent Current vs Load Current

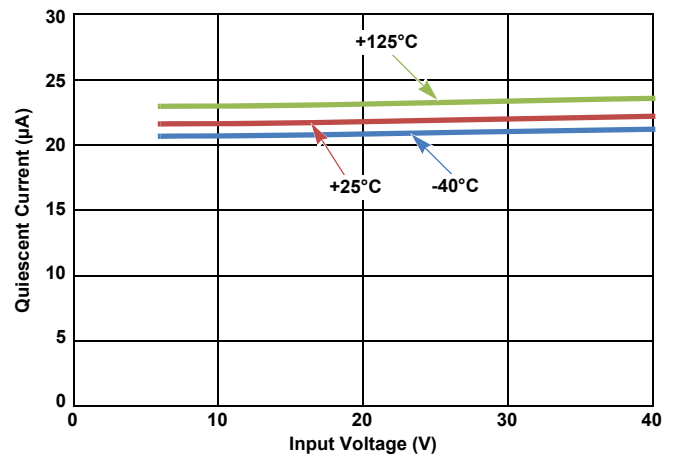

Figure 5. Quiescent Current vs Input Voltage (No Load)

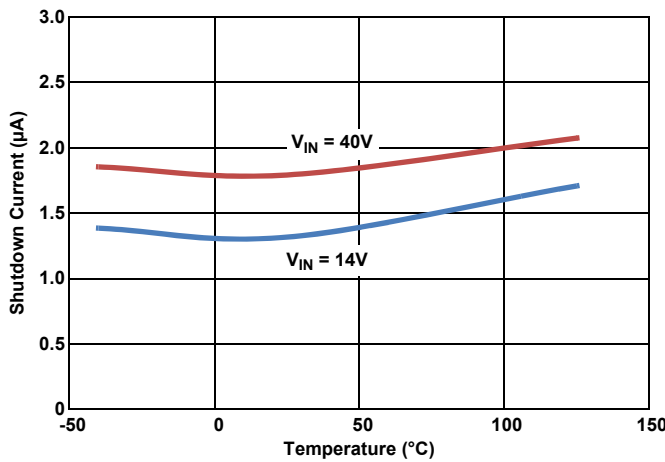

Figure 6. Shutdown Current vs Temperature (EN = 0)

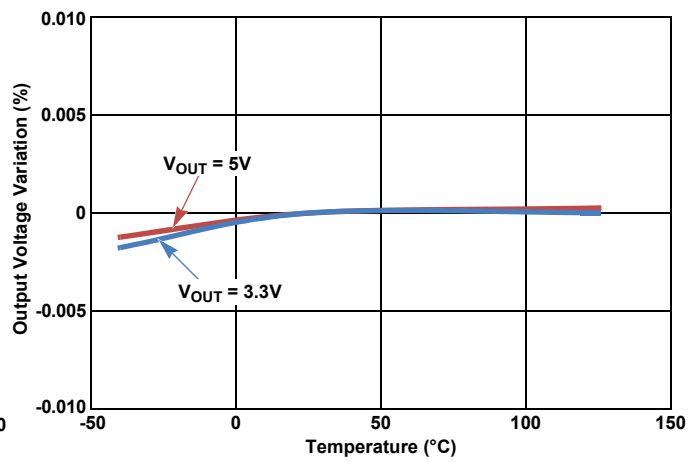

Figure 7. Output Voltage vs Temperature (Load = 50mA)

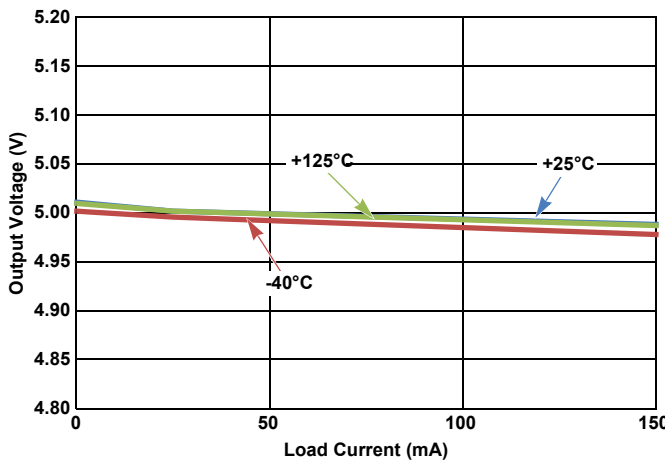

Figure 8. Output Voltage vs Load Current

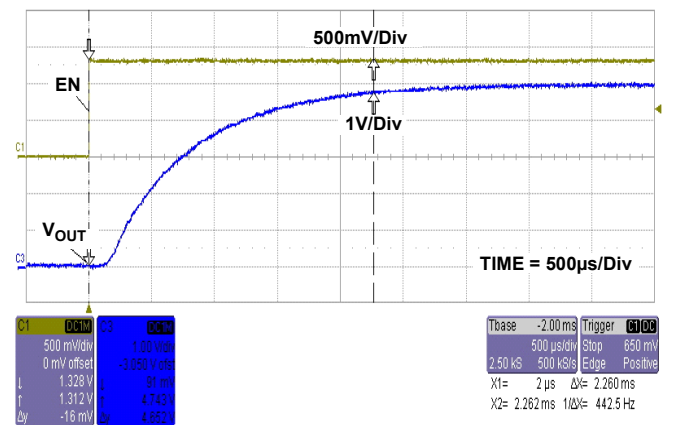

Figure 9. Start-Up Waveform

$V_{IN} = 14V$, $I_{OUT} = 1mA$, $V_{OUT} = 5V$, $T_J = +25^{\circ}C$, unless otherwise specified. (Continued)

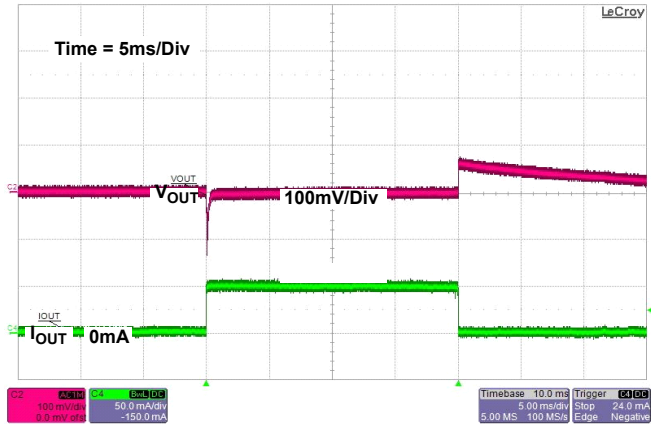

Figure 10. Load Transient Response

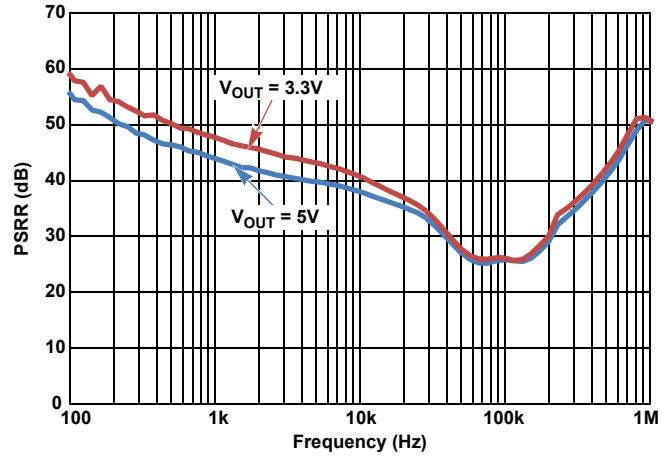

Figure 11. PSRR vs Frequency for Various Output Voltages, (Load = 150mA)

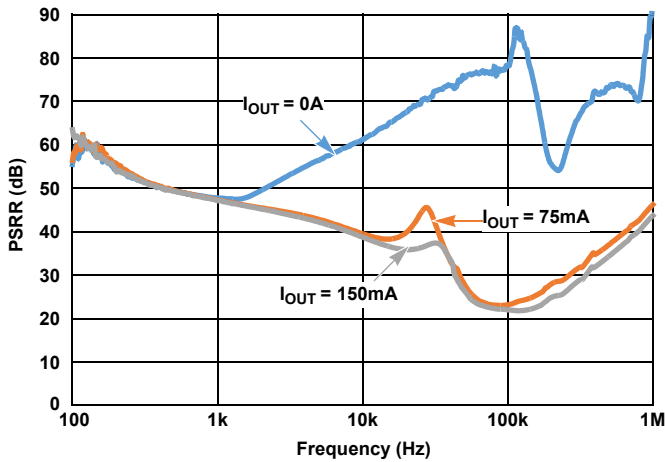

Figure 12. PSRR vs Frequency for Various Load Currents, $V_{OUT} = 3.3V$

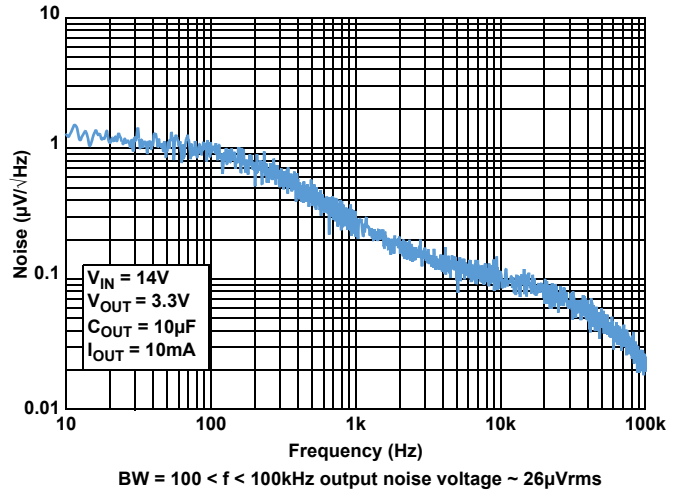

Figure 13. Output Noise Spectral Density, $I_{OUT} = 10mA$

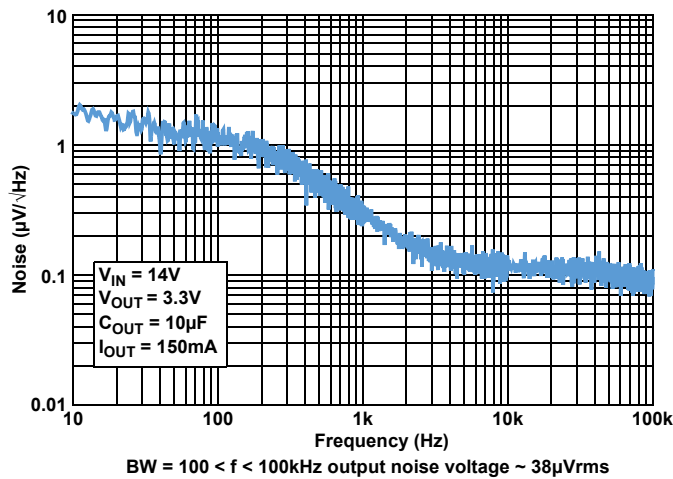

Figure 14. Output Noise Spectral Density, $I_{OUT} = 150mA$

4. Functional Description

4.1 Functional Overview

The ISL80410 is a high performance, high voltage, Low-Dropout regulator (LDO) with 150mA sourcing capability. The part is rated to operate across the -40°C to +125°C temperature range. Its ultra low quiescent current makes it an ideal choice for “always-on” applications. It works well under a “load dump condition” in which the input voltage could rise up to 40V. This LDO device also features current limit and thermal shutdown protection.

4.2 Enable Control

The ISL80410 has an enable pin, which turns the device on when pulled high. When EN is low, the IC goes into shutdown mode and draws less than 2μA of current. Tie the EN pin directly to IN for “always-on” operation.

4.3 Current Limit Protection

The ISL80410 has internal current limiting functionality to protect the regulator during fault conditions. During current limit, the output sources a fixed amount of current largely independent of the output voltage. If the short or overload is removed from V_{OUT} , the output returns to normal voltage regulation mode.

4.4 Thermal Fault Protection

If the die temperature exceeds a typical value of +165°C, the output of the LDO shuts down until the die temperature cools to a typical value of +145°C. The level of power dissipated, combined with the ambient temperature and the thermal impedance of the package, determines if the junction temperature exceeds the thermal shutdown temperature. See [“Power Dissipation” on page 9](#) for more details.

5. Application Information

5.1 Input and Output Capacitors

A minimum 0.1µF ceramic capacitor is recommended at the input for proper operation. For the output, a ceramic capacitor with a capacitance of 10µF is recommended for the ISL80410 to maintain stability. Route the ground connection of the output capacitor directly to the GND pin of the device and place it close to the IC.

5.2 Output Voltage Setting

The ISL80410 output voltage is programmed using an external resistor divider as shown in [Figure 15](#).

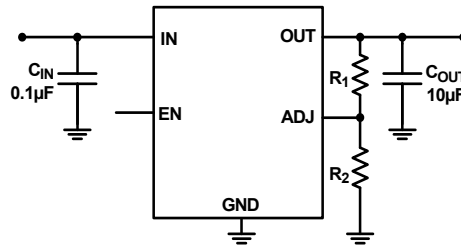

Figure 15. Output Voltage Setting

The output voltage is calculated using [Equation 1](#):

$$(EQ. 1) \quad V_{OUT} = 1.223V \times \left(\frac{R_1}{R_2} + 1 \right)$$

5.3 Power Dissipation

The junction temperature must not exceed the range specified in [“Recommended Operating Conditions” on page 4](#). The power dissipation can be calculated using [Equation 2](#):

$$(EQ. 2) \quad P_D = (V_{IN} - V_{OUT}) \times I_{OUT} + V_{IN} \times I_{GND}$$

The maximum allowable junction temperature, $T_{J(MAX)}$, and the maximum expected ambient temperature, $T_{A(MAX)}$, determine the maximum allowable junction temperature rise (ΔT_J), as shown in [Equation 3](#):

$$(EQ. 3) \quad \Delta T_J = T_{J(MAX)} - T_{A(MAX)}$$

To calculate the maximum ambient operating temperature, use the junction-to-ambient thermal resistance (θ_{JA}) as shown in [Equation 4](#):

$$(EQ. 4) \quad T_{J(MAX)} = P_{D(MAX)} \times \theta_{JA} + T_A$$

5.4 Board Layout Recommendations

A good Printed Circuit Board (PCB) layout is important to achieve expected performance. When placing the components and routing the trace, minimize the ground impedance and keep the parasitic inductance low. The input and output capacitors should have a good ground connection and be placed as close to the IC as possible. The feedback trace in the adjustable version should be away from other noisy traces. Connect the exposed pad to the ground plane using as many vias as possible within the pad for the best thermal relief.

6. Revision History

| Rev. | Date | Description |
|------|--------------|---|
| 2.01 | Oct 2, 2023 | Updated M8.15B POD to the latest revision (corrected typo). |
| 2.00 | Aug 8, 2019 | Updated POD to the latest revision. Changes are as follows: -Updated L Millimeter minimum in detail A from 0.41 to 0.406. -Updated the following in the Side View: -Changed total package height Millimeter MIN and MAX values from: 1.43 MIN and 1.68 MAX to: 1.422 MIN and 1.700 MAX and Inches max from 0.066 to 0.067. -Changed A1 Inches MIN from: 0.001 to 0.0, and A1 Millimeters MIN from 0.03 to 0.0 |
| 1.00 | Feb 8, 2019 | Updated title Updated the 6th bullet and added the 8th bullet in the features list. Updated Related Literature section. Updated ordering information table with tape and reel information and updated notes. Added Output Voltage Noise specification. |
| 0.00 | Jan 24, 2018 | Initial release. |

7. Package Outline Drawing

For the most recent package outline drawing, see [M8.15B](#).

M8.15B
 8 Lead Narrow Body Small Outline Exposed Pad Plastic Package
 Rev 8, 9/2023

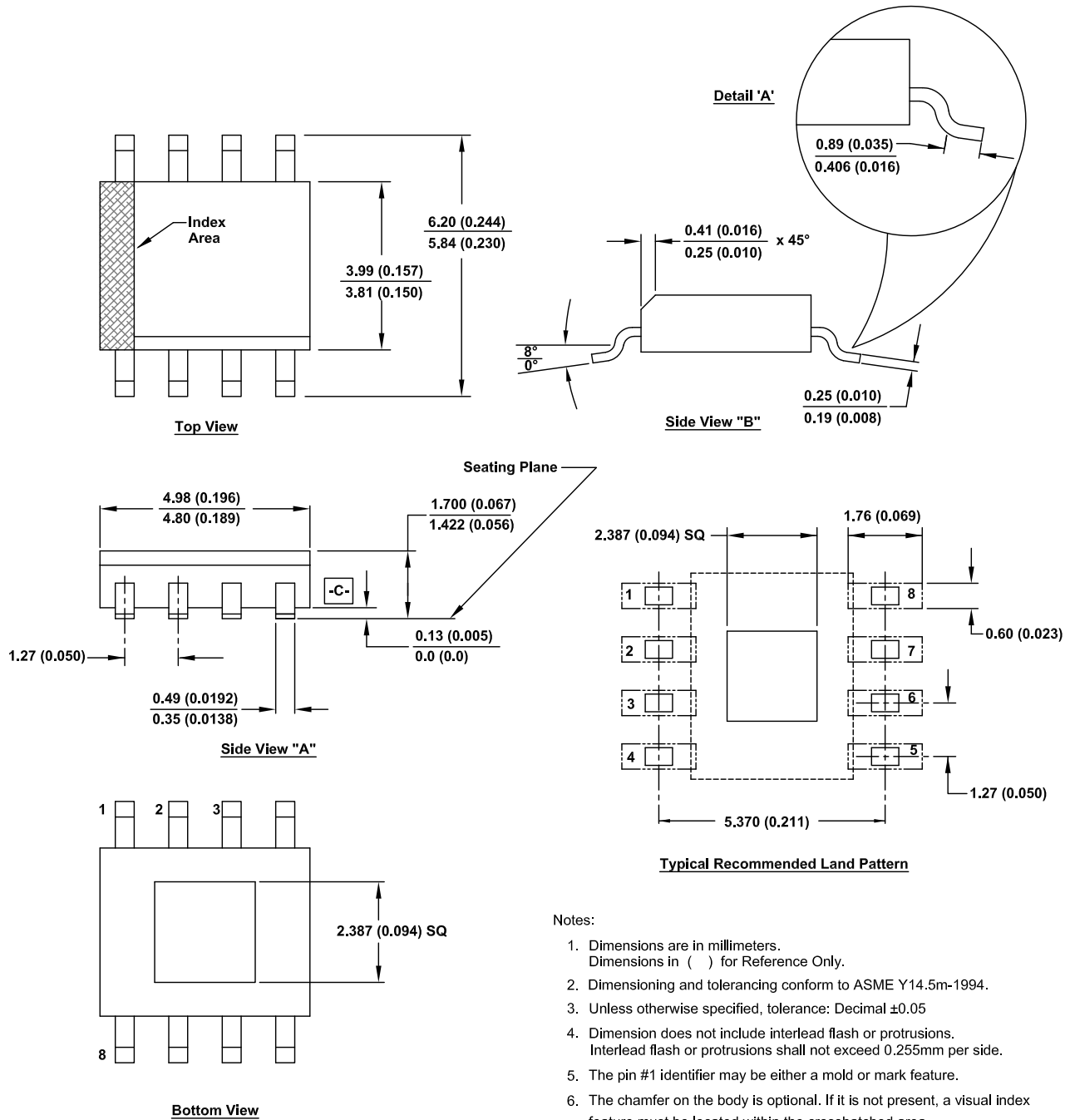

IMPORTANT NOTICE AND DISCLAIMER

RENESAS ELECTRONICS CORPORATION AND ITS SUBSIDIARIES (“RENESAS”) PROVIDES TECHNICAL SPECIFICATIONS AND RELIABILITY DATA (INCLUDING DATASHEETS), DESIGN RESOURCES (INCLUDING REFERENCE DESIGNS), APPLICATION OR OTHER DESIGN ADVICE, WEB TOOLS, SAFETY INFORMATION, AND OTHER RESOURCES “AS IS” AND WITH ALL FAULTS, AND DISCLAIMS ALL WARRANTIES, EXPRESS OR IMPLIED, INCLUDING, WITHOUT LIMITATION, ANY IMPLIED WARRANTIES OF MERCHANTABILITY, FITNESS FOR A PARTICULAR PURPOSE, OR NON-INFRINGEMENT OF THIRD PARTY INTELLECTUAL PROPERTY RIGHTS.

These resources are intended for developers skilled in the art designing with Renesas products. You are solely responsible for (1) selecting the appropriate products for your application, (2) designing, validating, and testing your application, and (3) ensuring your application meets applicable standards, and any other safety, security, or other requirements. These resources are subject to change without notice. Renesas grants you permission to use these resources only for development of an application that uses Renesas products. Other reproduction or use of these resources is strictly prohibited. No license is granted to any other Renesas intellectual property or to any third party intellectual property. Renesas disclaims responsibility for, and you will fully indemnify Renesas and its representatives against, any claims, damages, costs, losses, or liabilities arising out of your use of these resources. Renesas' products are provided only subject to Renesas' Terms and Conditions of Sale or other applicable terms agreed to in writing. No use of any Renesas resources expands or otherwise alters any applicable warranties or warranty disclaimers for these products.

(Disclaimer Rev.1.0 Mar 2020)

Corporate Headquarters

TOYOSU FORESIA, 3-2-24 Toyosu,
Koto-ku, Tokyo 135-0061, Japan
www.renesas.com

Contact Information

For further information on a product, technology, the most up-to-date version of a document, or your nearest sales office, please visit:
www.renesas.com/contact/

Trademarks

Renesas and the Renesas logo are trademarks of Renesas Electronics Corporation. All trademarks and registered trademarks are the property of their respective owners.

Looking for pricing, stock, or lifecycle information?

Click below to explore more details on WIN SOURCE:

- ⊖ [View ISL80410IBEZ on WIN SOURCE](#)
- ⊖ [Renesas Electronics America](#) Information

Optimize Your Supply Chain with WIN SOURCE Solutions

- ✓ Global Sourcing Solution
- ✓ Obsolete Management
- ✓ Cost Control Management
- ✓ Shortage Management
- ✓ Alternative Solution
- ✓ Excess Inventory Management