



**THE DATASHEET OF
NCV6324BMTAAWTBG**



Buck Converter - Synchronous 3 MHz, 2 A

NCP6324, NCV6324

The NCP/NCV6324, a family of synchronous buck converters, which is optimized to supply different sub systems of portable applications powered by one cell Li-ion or three cell Alkaline/NiCd/NiMH batteries. The devices are able to deliver up to 2 A on an external adjustable voltage. Operation with 3 MHz switching frequency allows employing small size inductor and capacitors. Input supply voltage feedforward control is employed to deal with wide input voltage range. Synchronous rectification and automatic PWM/PFM power save mode offer improved system efficiency. The NCP/NCV6324 is in a space saving, low profile 2.0 x 2.0 x 0.75 mm WDFN8 package or a WDFNW8 wettable flank package.

Features

- 2.5 V to 5.5 V Input Voltage Range
- External Adjustable Voltage
- Up to 2 A Output Current
- 3 MHz Switching Frequency
- Synchronous Rectification
- Automatic Power Save (NCx6324B) or External Mode Selection (NCx6324C)
- Enable Input
- Power Good Output Option (NCx6324B)
- Soft Start
- Over Current Protection
- Active Discharge When Disabled
- Thermal Shutdown Protection
- WDFN-8, 2 x 2 mm, 0.5 mm Pitch Package and WDFNW8, 2 x 2 mm, 0.5 mm Pitch Package with Wettable Flanks
- Maximum 0.8mm Height for Super Thin Applications
- NCV Prefix for Automotive and Other Applications Requiring Unique Site and Control Change Requirements; AEC-Q100 Qualified and PPAP Capable
- These Devices are Pb-Free, Halogen Free/BFR Free and are RoHS Compliant

Typical Applications

- Cellular Phones, Smart Phones, and PDAs
- Portable Media Players
- Digital Still Cameras
- Wireless and DSL Modems
- USB Powered Devices
- Point of Load
- Game and Entertainment System



ON Semiconductor®

www.onsemi.com



WDFN8
CASE 511BE



WDFNW8
CASE 511CL

MARKING DIAGRAM

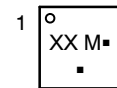

- XX = Specific Device Code
- M = Date Code
- = Pb-Free Package

(Note: Microdot may be in either location)

PINOUT

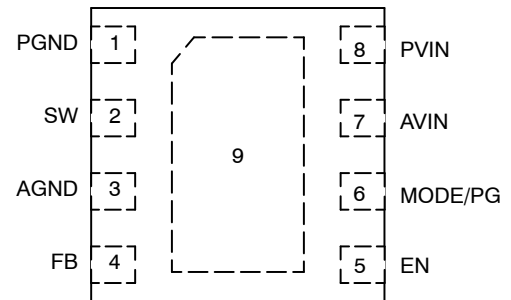

(Top View)

ORDERING INFORMATION

See detailed ordering, marking and shipping information on page 2 of this data sheet.

NCP6324, NCV6324

ORDERING INFORMATION

Device	Marking	Package	Shipping†
NCP6324BMTAATBG	4A	WDFN8 (Pb-Free)	3000 / Tape & Reel
NCV6324BMTAATBG*	CE		
NCP6324CMTAATBG	C4		
NCV6324CMTAATBG*	HA		
NCV6324BMTAAWTBG*	WC	WDFNW8 with Wettable Flanks (Pb-Free)	
NCV6324CMTAAWTBG*	LF		

†For information on tape and reel specifications, including part orientation and tape sizes, please refer to our Tape and Reel Packaging Specifications Brochure, BRD8011/D.

*NCV Prefix for Automotive and Other Applications Requiring Unique Site and Control Change Requirements; AEC-Q100 Qualified and PPAP Capable.

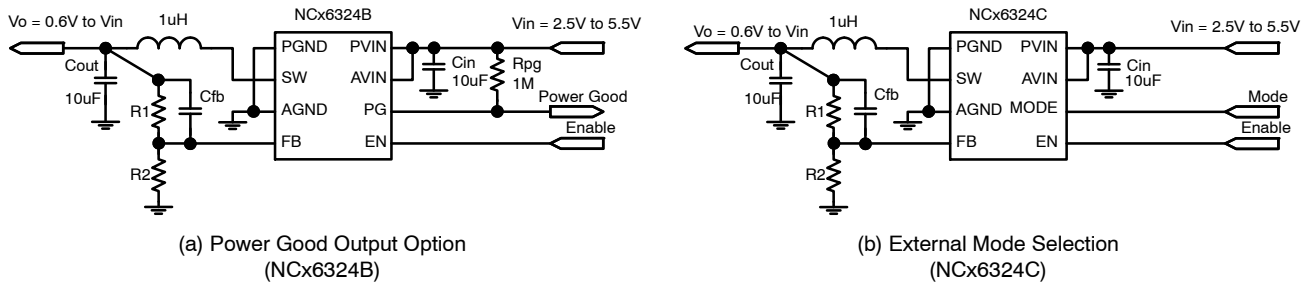

Figure 1. Typical Application Circuits

NCP6324, NCV6324

PIN DESCRIPTION

Pin	Name	Type	Description
1	PGND	Power Ground	Power Ground for power, analog blocks. Must be connected to the system ground.
2	SW	Power Output	Switch Power pin connects power transistors to one end of the inductor.
3	AGND	Analog Ground	Analog Ground analog and digital blocks. Must be connected to the system ground.
4	FB	Analog Input	Feedback Voltage from the buck converter output. This is the input to the error amplifier. This pin is connected to the resistor divider network between the output and AGND.
5	EN	Digital Input	Enable of the IC. High level at this pin enables the device. Low level at this pin disables the device.
6	PG/MODE	Digital Output	PG pin is for NCx6324B with Power Good option. It is open drain output. Low level at this pin indicates the device is not in power good, while high impedance at this pin indicates the device is in power good. When not used, PG pin of the NCx6324B can be left unconnected. MODE pin is for NCx6324C with mode external selection option. High level at this pin forces the device to operate in forced PWM mode. Low level at this pin enables the device to operate in automatic PFM/PWM mode for power saving function.
7	AVIN	Analog Input	Analog Supply. This pin is the analog and the digital supply of the device. An optional 1 μ F or larger ceramic capacitor bypasses this input to the ground. This capacitor should be placed as close as possible to this input.
8	PVIN	Power Input	Power Supply Input. This pin is the power supply of the device. A 10 μ F or larger ceramic capacitor must bypass this input to the ground. This capacitor should be placed as close a possible to this input.
9	PAD	Exposed Pad	Exposed Pad. Must be soldered to system ground to achieve power dissipation performances. This pin is internally unconnected

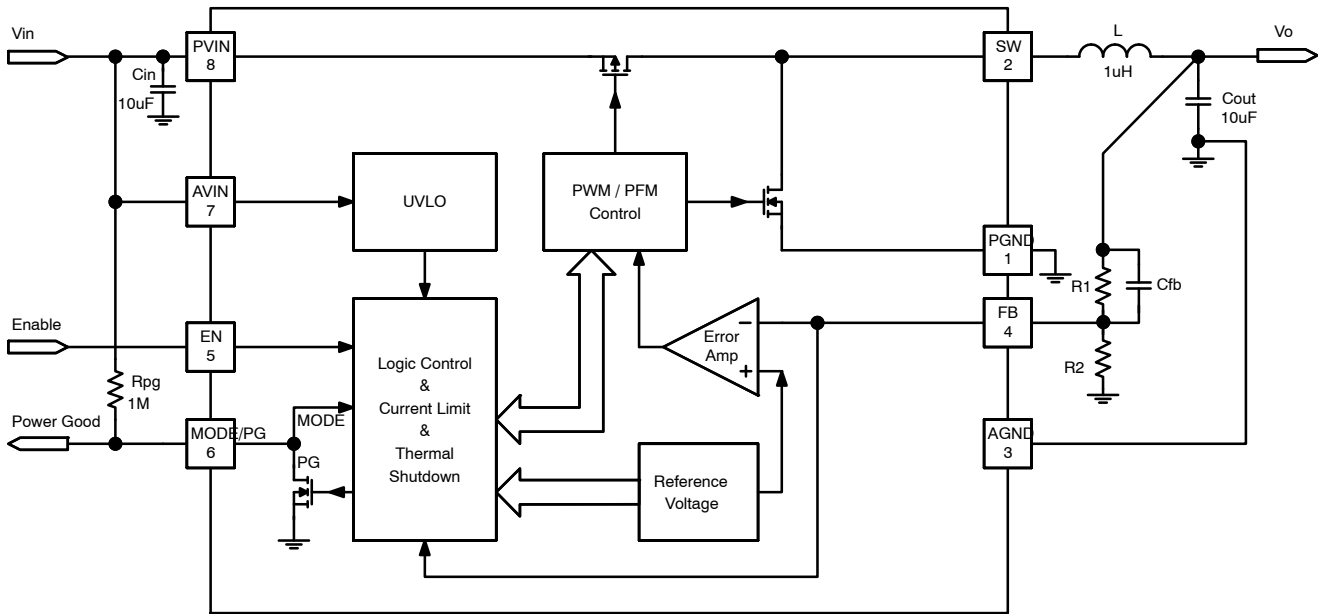

Figure 2. Functional Block Diagram

NCP6324, NCV6324

MAXIMUM RATINGS

Rating	Symbol	Value		Unit
		Min	Max	
Analog Pins DC non switching: AVIN, PG, FB, EN	V_{A-DC}	-0.3	6.0	V
Power Pins DC non switching: PVIN, SW	V_{P-DC}	-0.3	6.0	V
Between PVIN, PGND pins, transient 3 ns – 3 MHz	V_{P-TR}	-0.3	7.5	V
Human Body Model (HBM) ESD Rating are (Note 1)	ESD HBM		2000	V
Machine Model (MM) ESD Rating (Note 1)	ESD MM		200	V
Latchup Current (Note 2)	I_{LU}	-100	100	mA
Junction Temperature Range (Note 3)	T_{JMAX}	-40	TSD	°C
Storage Temperature Range	T_{STG}	-55	150	°C
Thermal Resistance Junction-to-Top Case (Note 4)	$R_{\theta JC}$	12		°C/W
Thermal Resistance Junction-to-Board (Note 4)	$R_{\theta JB}$	30		°C/W
Thermal Resistance Junction-to-Ambient (Note 4)	$R_{\theta JA}$	62		°C/W
Power Dissipation (Note 5)	P_D	1.6		W
Moisture Sensitivity Level (Note 6)	MSL	1		-

Stresses exceeding those listed in the Maximum Ratings table may damage the device. If any of these limits are exceeded, device functionality should not be assumed, damage may occur and reliability may be affected.

- This device series contains ESD protection and passes the following tests:
Human Body Model (HBM) ± 2.0 kV per JEDEC standard: JESD22-A114.
Machine Model (MM) ± 200 V per JEDEC standard: JESD22-A115.
- Latchup Current per JEDEC standard: JESD78 Class II.
- The thermal shutdown set to 150°C (typical) avoids potential irreversible damage on the device due to power dissipation.
- The thermal resistance values are dependent of the PCB heat dissipation. The board used to drive this data was an 80x50 mm NCP6324EVb board. It is a multilayer board with 1 ounce internal power and ground planes and 2-1 ounce copper traces on top and bottom of the board. If the copper traces of top and bottom are 1 ounce too, $R_{\theta JC} = 11^\circ\text{C/W}$, $R_{\theta JB} = 30^\circ\text{C/W}$, and $R_{\theta JA} = 72^\circ\text{C/W}$.
- The maximum power dissipation (PD) is dependent on input voltage, maximum output current and external components selected.
- Moisture Sensitivity Level (MSL): 1 per IPC/JEDEC standard: J-STD-020A.

RECOMMENDED OPERATING CONDITIONS

Rating	Symbol	Min	Typ	Max	Unit
Analog Input Supply	AV_{INR}	2.5	-	5.5	V
Power Input Supply	PV_{INR}	2.5	-	5.5	V
Operating Junction Temperature Range (Note 7)	T_J	-40	-	+125	°C
Inductor for DC to DC Converter (Note 8)	L_{OUT}	0.67	1.0	-	μH
Output Capacitor (Note 8, 9)	C_{OUT}	7.0	10	-	μF
Input Capacitor for Power Supply (Note 8)	C_{PVIN}	7.0	10	-	μF

Functional operation above the stresses listed in the Recommended Operating Ranges is not implied. Extended exposure to stresses beyond the Recommended Operating Ranges limits may affect device reliability.

- The thermal shutdown set to 170°C (typical) avoids potential irreversible damage due to power dissipation.
- Including de-ratings (Refer to the Application Information section of this document for further details).
- The output capacitor value contributes to the regulator loop stability. Special care should be taken for C_{OUT} selection. In case of doubt, please contact your sales office.

NCP6324, NCV6324

ELECTRICAL CHARACTERISTICS ($V_{IN} = 3.6\text{ V}$, $V_{OUT} = 1.8\text{ V}$, $L = 1\ \mu\text{H}$, $C = 10\ \mu\text{F}$, typical values are referenced to $T_J = 25^\circ\text{C}$, Min and Max values are referenced to T_J up to 125°C , unless other noted.)

Symbol	Characteristics	Test Conditions	Min	Typ	Max	Unit
--------	-----------------	-----------------	-----	-----	-----	------

SUPPLY VOLTAGE

V_{IN}	Input Voltage V_{IN} Range	(Note 13)	2.5	–	5.5	V
----------	------------------------------	-----------	-----	---	-----	---

SUPPLY CURRENT

I_Q	V_{IN} Quiescent Supply Current	EN high, no load, no switching, PFM Mode EN high, no load, Forced PWM Mode	– –	30 5.7	– –	μA mA
I_{SD}	V_{IN} Shutdown Current	EN low (Note 12 for NCP6324)	–	–	1	μA

OUTPUT VOLTAGE

V_{OUT}	Output Voltage Range	(Note 10)	0.6	–	V_{IN}	V
V_{FB}	FB Voltage	PWM Mode	594	600	606	mV
	FB Voltage in Load Regulation	$V_{IN} = 3.6\text{ V}$, I_{OUT} from 200 mA to I_{OUTMAX} , PWM mode (Note 10)	–	–0.5	–	%/A
	FB Voltage in Line Regulation	$I_{OUT} = 200\text{ mA}$, V_{IN} from MAX ($V_{NOM} + 0.5\text{ V}$, 2.5 V) to 5.5 V, PWM mode (Note 10)	–	0	–	%/V
D_{MAX}	Maximum Duty Cycle	(Note 10)	–	100	–	%

OUTPUT CURRENT

I_{OUTMAX}	Output Current Capability	(Note 10)	2.0	–	–	A
I_{LIMP}	Output Peak Current Limit P-Channel		2.3	2.8	3.3	A
I_{LIMN}	Output Peak Current Limit N-Channel			0.9		A

VOLTAGE MONITOR

V_{INUV-}	V_{IN} UVLO Falling Threshold		–	–	2.4	V
V_{INHYS}	V_{IN} UVLO Hysteresis		60	140	200	mV
V_{PGL}	Power Good Low Threshold	V_{OUT} falls down to cross the threshold (percentage of FB voltage) (Note 11)	87	90	92	%
V_{PGHYS}	Power Good Hysteresis	V_{OUT} rises up to cross the threshold (percentage of Power Good Low Threshold (V_{PGL}) voltage) (Note 11)	0	5	7	%
T_{dPGH1}	Power Good High Delay in Start Up	From EN rising edge to PG going high. (Note 11)	–	1.15	–	ms
T_{dPGL1}	Power Good Low Delay in Shut Down	From EN falling edge to PG going low. (Notes 10 and 11)	–	8	–	μs
T_{dPGH}	Power Good High Delay in Regulation	From V_{FB} going higher than 95% nominal level to PG going high. Not for the first time in start up. (Notes 10 and 11)	–	5	–	μs
T_{dPGL}	Power Good Low Delay in Regulation	From V_{FB} going lower than 90% nominal level to PG going low. (Notes 10 and 11)	–	8	–	μs
V_{PG_L}	Power Good Pin Low Voltage	Voltage at PG pin with 5 mA sink current (Note 11)	–	–	0.3	V
PG_LK	Power Good Pin Leakage Current	3.6 V at PG pin when power good valid (Note 11)	–	–	100	nA

INTEGRATED MOSFETS

R_{ON_H}	High-Side MOSFET ON Resistance	$V_{IN} = 3.6\text{ V}$ (Note 12 for NCP6324) $V_{IN} = 5\text{ V}$ (Note 12 for NCP6324)	– –	160 130	200 –	$\text{m}\Omega$
R_{ON_L}	Low-Side MOSFET ON Resistance	$V_{IN} = 3.6\text{ V}$ (Note 12 for NCP6324) $V_{IN} = 5\text{ V}$ (Note 12 for NCP6324)	– –	110 100	140 –	$\text{m}\Omega$

10. Guaranteed by design, not tested in production.

11. Power Good function is for NCx6324B devices only.

12. Maximum value applies for $T_J = 85^\circ\text{C}$.

13. Operation above 5.5 V input voltage for extended periods may affect device reliability. At the first power-up, input voltage must be $> 2.6\text{ V}$.

NCP6324, NCV6324

ELECTRICAL CHARACTERISTICS ($V_{IN} = 3.6\text{ V}$, $V_{OUT} = 1.8\text{ V}$, $L = 1\ \mu\text{H}$, $C = 10\ \mu\text{F}$, typical values are referenced to $T_J = 25^\circ\text{C}$, Min and Max values are referenced to T_J up to 125°C , unless other noted.)

Symbol	Characteristics	Test Conditions	Min	Typ	Max	Unit
--------	-----------------	-----------------	-----	-----	-----	------

SWITCHING FREQUENCY

F_{SW}	Normal Operation Frequency		2.7	3.0	3.3	MHz
----------	----------------------------	--	-----	-----	-----	-----

SOFT START

T_{START}	Start Time	Time from EN to 90% of output voltage target	0	0.18	1	ms
T_{SS}	Soft-Start Time	Time from 10% to 90% of output voltage target	–	0.1	–	ms

CONTROL LOGIC

V_{EN_H}	EN Input High Voltage		1.1	–	–	V
V_{EN_L}	EN Input Low Voltage		–	–	0.4	V
V_{EN_HYS}	EN Input Hysteresis		–	270	–	mV
I_{EN_BIAS}	EN Input Bias Current			0.1	1	μA
V_{MODE_H}	MODE Input High Voltage	(Note 14)	1.1	–	–	V
V_{MODE_L}	MODE Input Low Voltage	(Note 14)	–	–	0.4	V
V_{MODE_HYS}	MODE Input Hysteresis	(Note 14)	–	270	–	mV
I_{MODE_BIAS}	MODE Input Bias Current	(Note 14)		0.1	1	μA

OUTPUT ACTIVE DISCHARGE

R_{DIS}	Internal Output Discharge Resistance	from SW to PGND	75	500	700	Ω
-----------	--------------------------------------	-----------------	----	-----	-----	----------

THERMAL SHUTDOWN

T_{SD}	Thermal Shutdown Threshold		–	150	–	$^\circ\text{C}$
T_{SD_HYS}	Thermal Shutdown Hysteresis		–	25	–	$^\circ\text{C}$

Product parametric performance is indicated in the Electrical Characteristics for the listed test conditions, unless otherwise noted. Product performance may not be indicated by the Electrical Characteristics if operated under different conditions.

14. Mode function is for NCx6324C devices only.

TYPICAL OPERATING CHARACTERISTICS

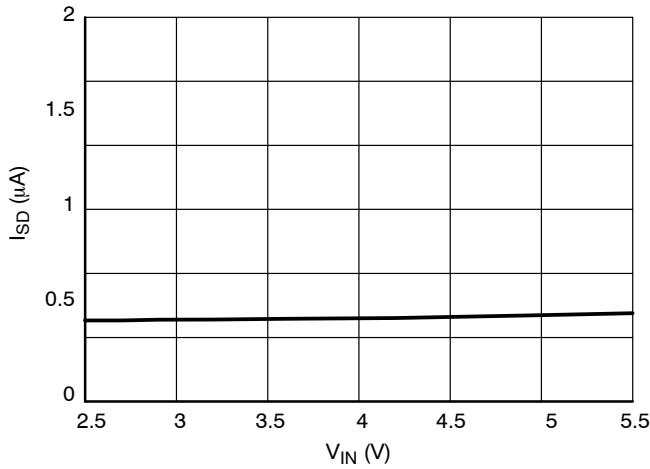

Figure 3. Shutdown Current vs. Input Voltage
(EN = Low, $T_A = 25^\circ\text{C}$)

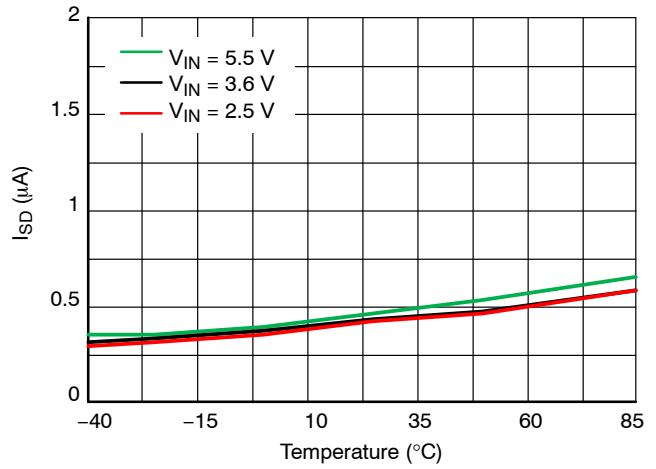

Figure 4. Shutdown Current vs. Temperature
(EN = Low, $V_{IN} = 3.6\text{ V}$)

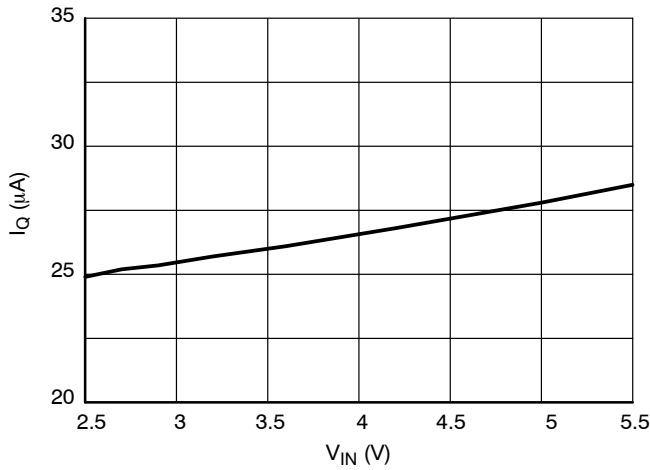

Figure 5. Quiescent Current vs. Input Voltage
(EN = High, Open Loop, $V_{OUT} = 1.8\text{ V}$,
 $T_A = 25^\circ\text{C}$)

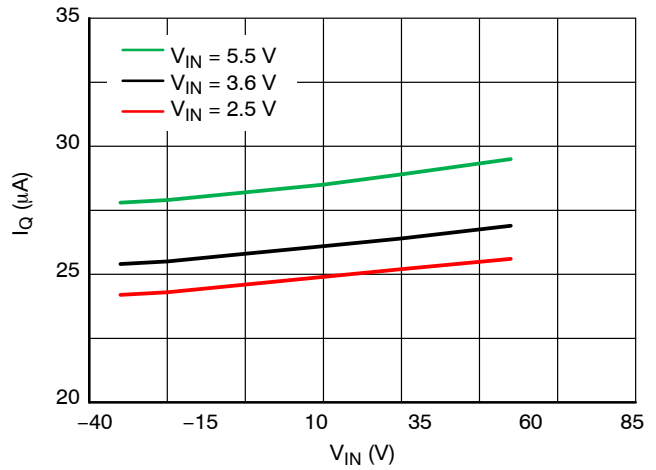

Figure 6. Quiescent Current vs. Temperature
(EN = High, Open Loop, $V_{OUT} = 1.8\text{ V}$,
 $V_{IN} = 3.6\text{ V}$)

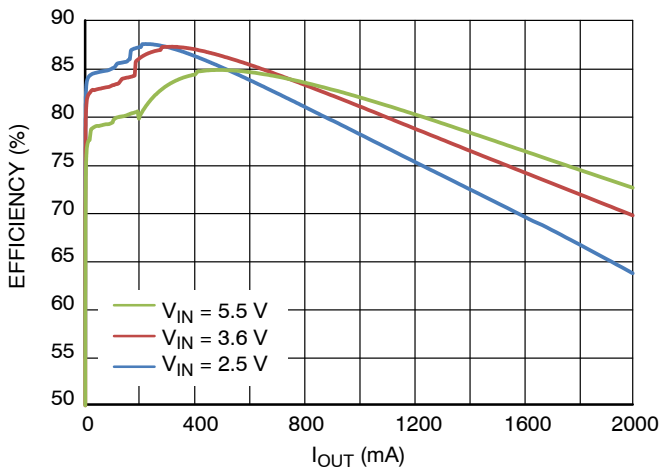

Figure 7. Efficiency vs. Output Current and
Input Voltage ($V_{OUT} = 1.05\text{ V}$, $T_A = 25^\circ\text{C}$)

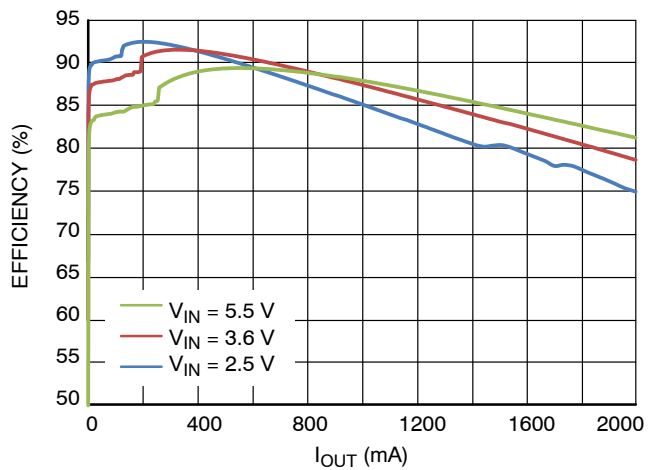

Figure 8. Efficiency vs. Output Current and
Input Voltage ($V_{OUT} = 1.8\text{ V}$, $T_A = 25^\circ\text{C}$)

NCP6324, NCV6324

TYPICAL OPERATING CHARACTERISTICS

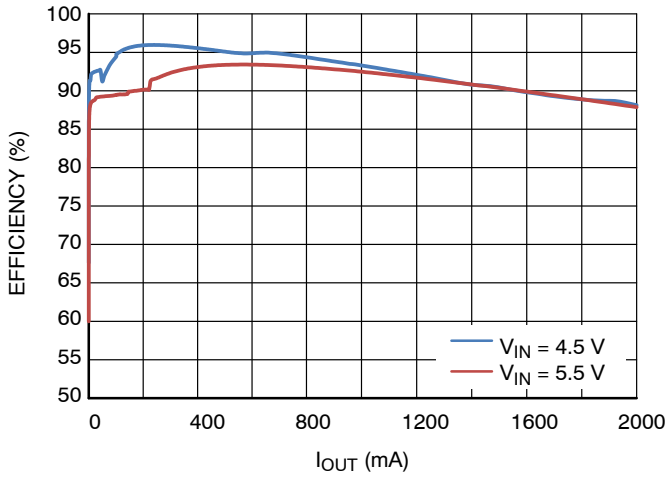

Figure 9. Efficiency vs. Output Current and Input Voltage ($V_{OUT} = 3.3\text{ V}$, $T_A = 25^\circ\text{C}$)

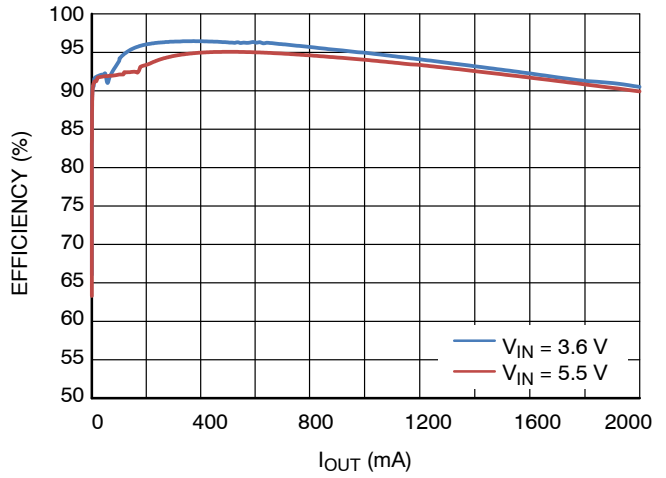

Figure 10. Efficiency vs. Output Current and Input Voltage ($V_{OUT} = 4\text{ V}$, $T_A = 25^\circ\text{C}$)

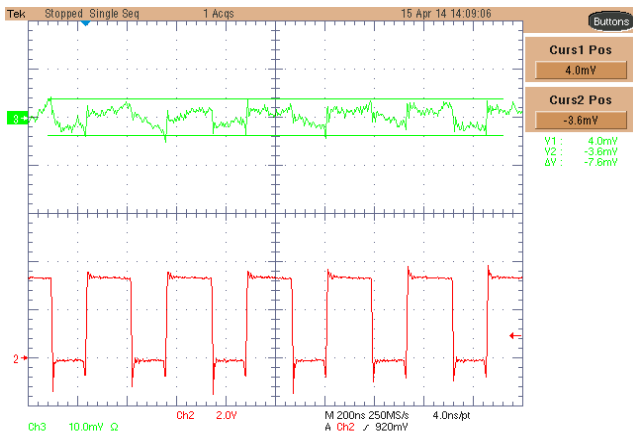

Figure 11. Output Ripple Voltage in PWM Mode ($V_{IN} = 3.6\text{ V}$, $V_{OUT} = 1.8\text{ V}$, $I_{OUT} = 1\text{ A}$, $L = 1\text{ }\mu\text{H}$, $C_{OUT} = 10\text{ }\mu\text{F}$)

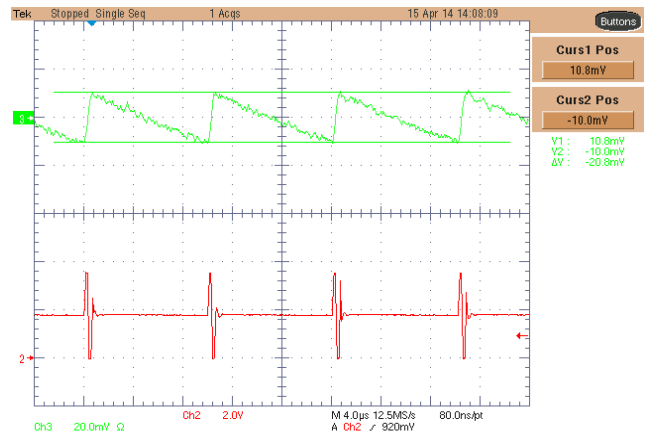

Figure 12. Output Ripple Voltage in PFM Mode ($V_{IN} = 3.6\text{ V}$, $V_{OUT} = 1.8\text{ V}$, $I_{OUT} = 10\text{ mA}$, $L = 1\text{ }\mu\text{H}$, $C_{OUT} = 10\text{ }\mu\text{F}$)

TYPICAL OPERATING CHARACTERISTICS

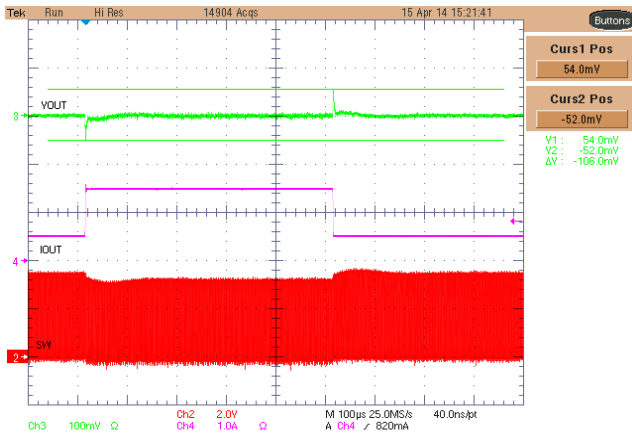

Figure 13. Load Transient Response ($V_{IN} = 3.6\text{ V}$, $V_{OUT} = 1.8\text{ V}$, $I_{OUT} = 500\text{ mA}$ to 1500 mA , $L = 1\text{ }\mu\text{H}$, $C_{OUT} = 10\text{ }\mu\text{F}$)

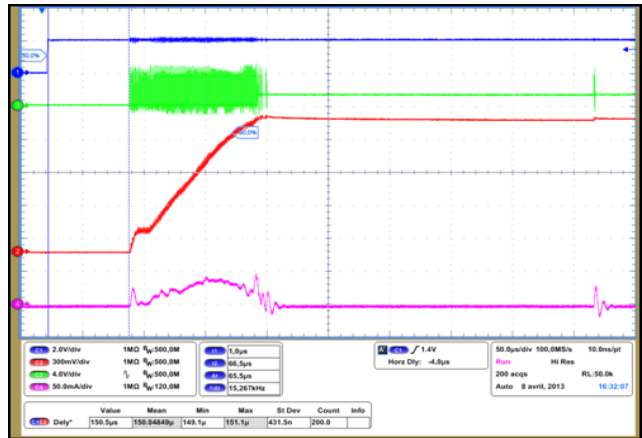

Figure 14. Power Up Sequence and Inrush Current in Input ($V_{IN} = 3.6\text{ V}$, $V_{OUT} = 1.8\text{ V}$, $I_{OUT} = 0\text{ A}$, $L = 1\text{ }\mu\text{H}$, $C_{OUT} = 10\text{ }\mu\text{F}$)

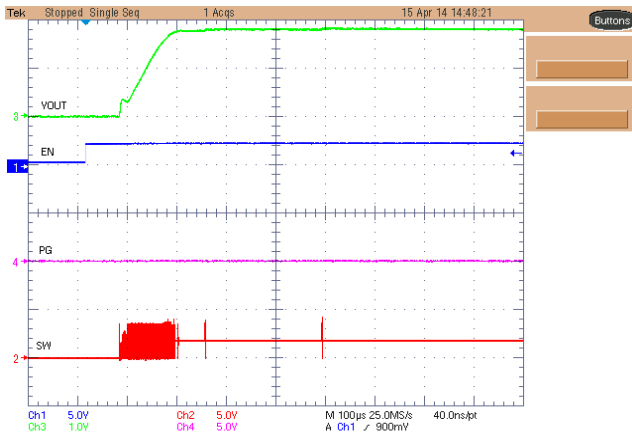

Figure 15. Power Up Sequence and Power Good ($V_{IN} = 3.6\text{ V}$, $V_{OUT} = 1.8\text{ V}$, $I_{OUT} = 0\text{ A}$, $L = 1\text{ }\mu\text{H}$, $C_{OUT} = 10\text{ }\mu\text{F}$)

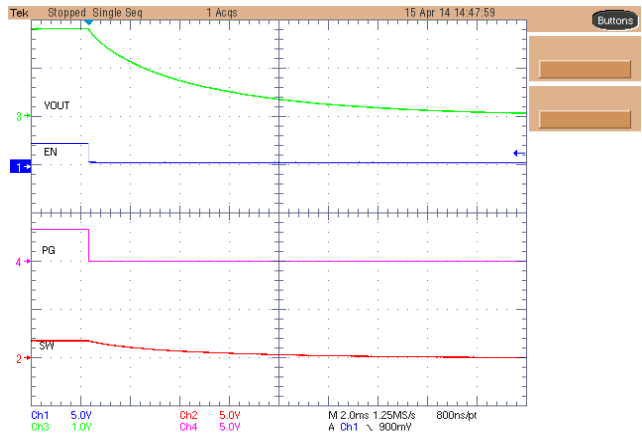

Figure 16. Power Down Sequence and Active Output Discharge ($V_{IN} = 3.6\text{ V}$, $V_{OUT} = 1.8\text{ V}$, $I_{OUT} = 0\text{ A}$, $L = 1\text{ }\mu\text{H}$, $C_{OUT} = 10\text{ }\mu\text{F}$)

DETAILED DESCRIPTION

General

The NCP/NCV6324, a family of voltage-mode synchronous buck converters, which is optimized to supply different sub-systems of portable applications powered by one cell Li-ion or three cell Alkaline/NiCd/NiMH batteries. The devices are able to deliver up to 2 A on an external adjustable voltage. Operation with 3 MHz switching frequency allows employing small size inductor and capacitors. Input supply voltage feedforward control is employed to deal with wide input voltage range. Synchronous rectification and automatic PWM/PFM power save mode offer improved system efficiency.

Operation Mode Selection (NCx6324C)

For NCx6324C with an external mode selection option, high level (above 1.1 V) at MODE pin forces the device to operate in forced PWM mode. Low level (below 0.4 V) at this pin enables the device to operate in automatic PFM/PWM mode for power saving function.

PWM Mode Operation

In medium and heavy load range, the inductor current is continuous and the device operates in PWM mode with fixed switching frequency, which has a typical value of 3 MHz. In this mode, the output voltage is regulated by on-time pulse width modulation of an internal P-MOSFET. An internal N-MOSFET operates as synchronous rectifier and its turn-on signal is complimentary to that of the P-MOSFET.

PFM Mode Operation

In light load range, the inductor current becomes discontinuous and the device automatically operates in PFM mode with an adaptive fixed on time and variable switching frequency. In this mode, the output voltage is regulated by pulse frequency modulation of the internal P-MOSFET, and the switching frequency is almost proportional to the loading current. The internal N-MOSFET operates as synchronous rectifier after each on pulse of the P-MOSFET with a very small negative current limit. When the load increases and the inductor current becomes continuous, the controller automatically turns back to the fixed-frequency PWM mode operation.

Undervoltage Lockout

The input voltage V_{IN} must reach or exceed 2.4 V (typical) before the NCP/NCV6324 enables the converter output to begin the start up sequence. The UVLO threshold hysteresis is typically 100 mV.

Enable

The NCP/NCV6324 has an enable logic input pin EN. A high level (above 1.1 V) on this pin enables the device to active mode. A low level (below 0.4 V) on this pin disables the device and makes the device in shutdown mode. There is an internal filter with 5 μ s time constant. The EN pin is pulled down by an internal 10 nA sink current source. In most of applications, the EN signal can be programmed independently to V_{IN} power sequence.

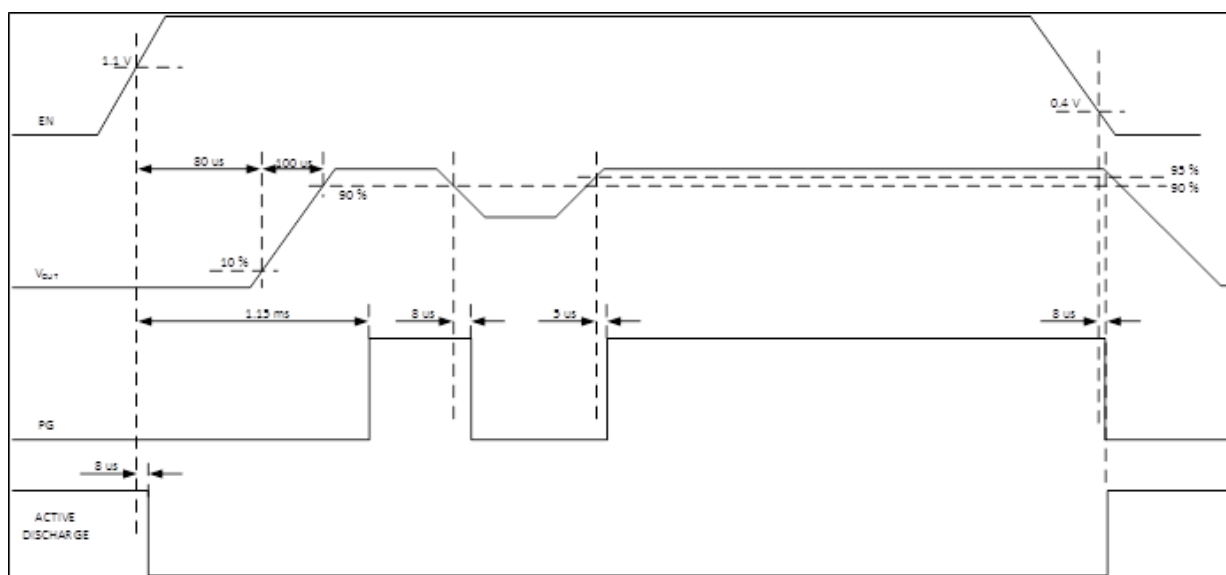

Figure 17. Power Good and Active Discharge Timing Diagram

Power Good Output (NCx6324B)

For NCx6324B with a power good output, the device monitors the output voltage and provides a power good output signal at the PG pin. This pin is an open-drain output pin. To indicate the output of the converter is established, a

power good signal is available. The power good signal is low when EN is high but the output voltage has not been established. Once the output voltage of the converter drops out below 90% of its regulation during operation, the power good signal is pulled low and indicates a power failure. A 5%

NCP6324, NCV6324

hysteresis is required on power good comparator before signal going high again. When not used, it is allowed to leave this pin unconnected.

Soft-Start

A soft start limits inrush current when the converter is enabled. After a minimum 80 μ s delay time following the enable signal, the output voltage starts to ramp up. Ramping from 10% to 90% of the target voltage takes 100 μ s, typical.

Active Output Discharge

An output discharge operation is active in when EN is low. A discharge resistor (500 Ω typical) is enabled in this condition to discharge the output capacitor through SW pin.

Cycle-by-Cycle Current Limitation

The NCP/NCV6324 protects the device from over current with a fixed-value cycle-by-cycle current limitation. The typical peak current limit ILMT is 2.8 A. If inductor current exceeds the current limit threshold, the P-MOSFET will be

turned off cycle-by-cycle. The maximum output current can be calculated by

$$I_{MAX} = I_{LMT} - \frac{V_{OUT} \cdot (V_{IN} - V_{OUT})}{2 \cdot V_{IN} \cdot f_{SW} \cdot L} \quad (\text{eq. 1})$$

where VIN is input supply voltage, VOUT is output voltage, L is inductance of the filter inductor, and f_{SW} is 3 MHz normal switching frequency.

Negative Current Protection

The NCP/NCV6324 includes a 1 A negative current protection. It helps to protect the internal NMOS in case of applications which require high output capacitor value.

Thermal Shutdown

The NCP/NCV6324 has a thermal shutdown protection to protect the device from overheating when the die temperature exceeds 150°C. After the thermal protection is triggered, the fault state can be ended by re-applying VIN and/or EN when the temperature drops down below 125°C.

APPLICATION INFORMATION

Output Filter Design Considerations

The output filter introduces a double pole in the system at a frequency of

$$f_{LC} = \frac{1}{2 \cdot \pi \cdot \sqrt{L \cdot C}} \quad (\text{eq. 2})$$

The internal compensation network design of the NCP/NCV6324 is optimized for the typical output filter comprised of a 1.0 μH inductor and a 10 μF ceramic output capacitor, which has a double pole frequency at about 50 kHz. Other possible output filter combinations may have a double pole around 50 kHz to have optimum operation with the typical feedback network. Normal selection range of the inductor is from 0.47 μH to 4.7 μH, and normal selection range of the output capacitor is from 4.7 μF to 22 μF.

Inductor Selection

The inductance of the inductor is determined by given peak-to-peak ripple current I_{L_PP} of approximately 20%

to 50% of the maximum output current I_{OUT_MAX} for a trade-off between transient response and output ripple. The inductance corresponding to the given current ripple is

$$L = \frac{(V_{IN} - V_{OUT}) \cdot V_{OUT}}{V_{IN} \cdot f_{SW} \cdot I_{L_PP}} \quad (\text{eq. 3})$$

The selected inductor must have high enough saturation current rating to be higher than the maximum peak current that is

$$I_{L_MAX} = I_{OUT_MAX} + \frac{I_{L_PP}}{2} \quad (\text{eq. 4})$$

The inductor also needs to have high enough current rating based on temperature rise concern. Low DCR is good for efficiency improvement and temperature rise reduction. Table 1 shows some recommended inductors for high power applications and Table 2 shows some recommended inductors for low power applications.

Table 1. LIST OF RECOMMENDED INDUCTORS FOR HIGH POWER APPLICATIONS

Manufacturer	Part Number	Case Size (mm)	L (μH)	Rated Current (mA) (Inductance Drop)	Structure
MURATA	LQH44PN2R2MP0	4.0 x 4.0 x 1.8	2.2	2500 (-30%)	Wire Wound
MURATA	LQH44PN1R0NP0	4.0 x 4.0 x 1.8	1.0	2950 (-30%)	Wire Wound
MURATA	LQH32PNR47NNP0	3.0 x 2.5 x 1.7	0.47	3400 (-30%)	Wire Wound

Table 2. LIST OF RECOMMENDED INDUCTORS FOR LOW POWER APPLICATIONS

Manufacturer	Part Number	Case Size (mm)	L (μH)	Rated Current (mA) (Inductance Drop)	Structure
MURATA	LQH44PN2R2MJ0	4.0 x 4.0 x 1.1	2.2	1320 (-30%)	Wire Wound
MURATA	LQH44PN1R0NJ0	4.0 x 4.0 x 1.1	1.0	2000 (-30%)	Wire Wound
TDK	VLS201612ET-2R2	2.0 x 1.6 x 1.2	2.2	1150 (-30%)	Wire Wound
TDK	VLS201612ET-1R0	2.0 x 1.6 x 1.2	1.0	1650 (-30%)	Wire Wound

Output Capacitor Selection

The output capacitor selection is determined by output voltage ripple and load transient response requirement. For a given peak-to-peak ripple current I_{L_PP} in the inductor of the output filter, the output voltage ripple across the output capacitor is the sum of three ripple components as below.

$$V_{OUT_PP} \approx V_{OUT_PP(C)} + V_{OUT_PP(ESR)} + V_{OUT_PP(ESL)} \quad (\text{eq. 5})$$

where $V_{OUT_PP(C)}$ is a ripple component by an equivalent total capacitance of the output capacitors, $V_{OUT_PP(ESR)}$ is a ripple component by an equivalent ESR of the output capacitors, and $V_{OUT_PP(ESL)}$ is a ripple component by an equivalent ESL of the output capacitors. In PWM

operation mode, the three ripple components can be obtained by

$$V_{OUT_PP(C)} = \frac{I_{L_PP}}{8 \cdot C \cdot f_{SW}} \quad (\text{eq. 6})$$

$$V_{OUT_PP(ESR)} = I_{L_PP} \cdot ESR \quad (\text{eq. 7})$$

$$V_{OUT_PP(ESL)} = \frac{ESL}{ESL + L} \cdot V_{IN} \quad (\text{eq. 8})$$

and the peak-to-peak ripple current is

$$I_{L_PP} = \frac{(V_{IN} - V_{OUT}) \cdot V_{OUT}}{V_{IN} \cdot f_{SW} \cdot L} \quad (\text{eq. 9})$$

NCP6324, NCV6324

In applications with all ceramic output capacitors, the main ripple component of the output ripple is $V_{OUT_PP}(C)$. So that the minimum output capacitance can be calculated regarding to a given output ripple requirement V_{OUT_PP} in PWM operation mode.

$$C_{MIN} = \frac{I_{L_PP}}{8 \cdot V_{OUT_PP} \cdot f_{SW}} \quad (\text{eq. 10})$$

Input Capacitor Selection

One of the input capacitor selection guides is the input voltage ripple requirement. To minimize the input voltage ripple and get better decoupling in the input power supply rail, ceramic capacitor is recommended due to low ESR and ESL. The minimum input capacitance regarding to the input ripple voltage V_{IN_PP} is

$$C_{IN_MIN} = \frac{I_{OUT_MAX} \cdot (D - D^2)}{V_{IN_PP} \cdot f_{SW}} \quad (\text{eq. 11})$$

where

$$D = \frac{V_{OUT}}{V_{IN}} \quad (\text{eq. 12})$$

In addition, the input capacitor needs to be able to absorb the input current, which has a RMS value of

$$I_{IN_RMS} = I_{OUT_MAX} \cdot \sqrt{D - D^2} \quad (\text{eq. 13})$$

The input capacitor also needs to be sufficient to protect the device from over voltage spike, and normally at least a 4.7 μF capacitor is required. The input capacitor should be located as close as possible to the IC on PCB.

Table 3. LIST OF RECOMMENDED INPUT CAPACITORS AND OUTPUT CAPACITORS

Manufacturer	Part Number	Case Size	Height Max (mm)	C (μF)	Rated Voltage (V)	Structure
MURATA	GRM21BR60J226ME39, X5R	0805	1.4	22	6.3	MLCC
TDK	C2012X5R0J226M, X5R	0805	1.25	22	6.3	MLCC
MURATA	GRM21BR61A106KE19, X5R	0805	1.35	10	10	MLCC
TDK	C2012X5R1A106M, X5R	0805	1.25	10	10	MLCC
MURATA	GRM188R60J106ME47, X5R	0603	0.9	10	6.3	MLCC
TDK	C1608X5R0J106M, X5R	0603	0.8	10	6.3	MLCC
MURATA	GRM188R60J475KE19, X5R	0603	0.87	4.7	6.3	MLCC

Design of Feedback Network

For NCP/NCV6324 devices with an external adjustable output voltage, the output voltage is programmed by an external resistor divider connected from V_{OUT} to FB and then to AGND, as shown in the typical application schematic Figure 1(a). The programmed output voltage is

$$V_{OUT} = V_{FB} \cdot \left(1 + \frac{R_1}{R_2} \right) \quad (\text{eq. 14})$$

where V_{FB} is equal to the internal reference voltage 0.6 V, R_1 is the resistance from V_{OUT} to FB, which has a normal value range from 50 k Ω to 1 M Ω and a typical value of

220 k Ω for applications with the typical output filter. R_2 is the resistance from FB to AGND, which is used to program the output voltage according to equation (14) once the value of R_1 has been selected. A capacitor C_{fb} needs to be employed between the V_{OUT} and FB in order to provide feedforward function to achieve optimum transient response. Normal value range of C_{fb} is from 0 to 100 pF, and a typical value is 15 pF for applications with the typical output filter and $R_1 = 220$ k Ω .

Table 4 provides reference values of R_1 and C_{fb} in case of different output filter combinations. The final design may need to be fine tuned regarding to application specifications.

Table 4. Reference Values of Feedback Networks (R_1 and C_{fb}) for Output Filter Combinations (L and C)

R_1 (k Ω)		L (μH)					
C_{fb} (pF)		0.47	0.68	1	2.2	3.3	4.7
C (μF)	4.7	220	220	220	220	330	330
		3	5	8	15	15	22
	10	220	220	220	220	330	330
		8	10	15	27	27	39
	22	220	220	220	220	330	330
		15	22	27	39	47	56

LAYOUT CONSIDERATIONS

Electrical Layout Considerations

Good electrical layout is a key to make sure proper operation, high efficiency, and noise reduction. Electrical layout guidelines are:

- Use wide and short traces for power paths (such as PVIN, VOUT, SW, and PGND) to reduce parasitic inductance and high-frequency loop area. It is also good for efficiency improvement.
- The device should be well decoupled by input capacitor and input loop area should be as small as possible to reduce parasitic inductance, input voltage spike, and noise emission.
- SW node should be a large copper pour, but compact because it is also a noise source.
- It would be good to have separated ground planes for PGND and AGND and connect the two planes at one point. Directly connect AGND pin to the exposed pad and then connect to AGND ground plane through vias. Try best to avoid overlap of input ground loop and output ground loop to prevent noise impact on output regulation.

- Arrange a “quiet” path for output voltage sense and feedback network, and make it surrounded by a ground plane.

Thermal Layout Considerations

Good thermal layout helps high power dissipation from a small package with reduced temperature rise. Thermal layout guidelines are:

- The exposed pad must be well soldered on the board.
- A four or more layers PCB board with solid ground planes is preferred for better heat dissipation.
- More free vias are welcome to be around IC and/or underneath the exposed pad to connect the inner ground layers to reduce thermal impedance.
- Use large area copper especially in top layer to help thermal conduction and radiation.
- Do not put the inductor to be too close to the IC, thus the heat sources are distributed.

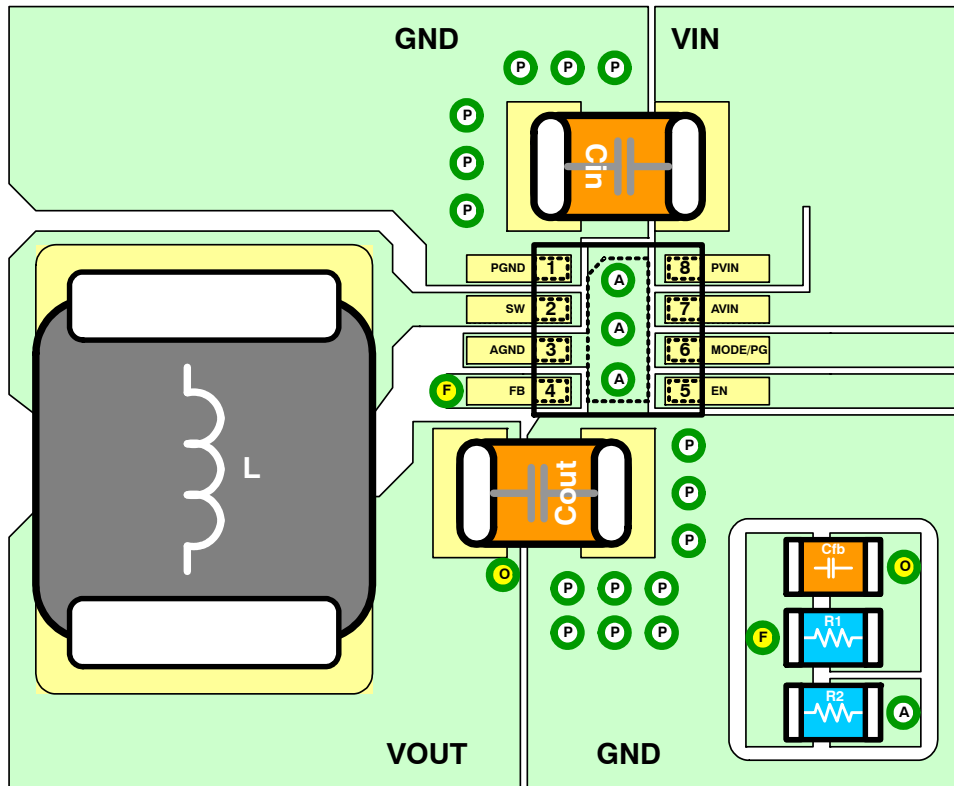

Figure 18. Recommended PCB Layout for Application Boards

MECHANICAL CASE OUTLINE

PACKAGE DIMENSIONS

ON Semiconductor®



SCALE 2:1

WDFN8 2x2, 0.5P
CASE 511BE-01
ISSUE A

DATE 27 MAY 2011

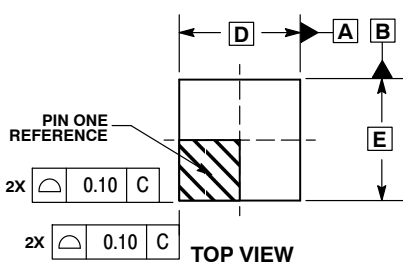

TOP VIEW

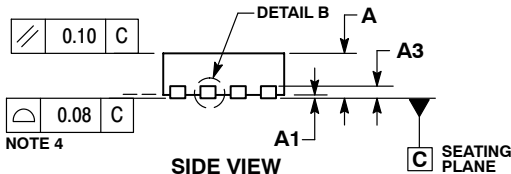

SIDE VIEW

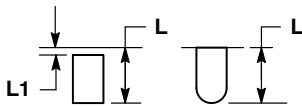

DETAIL A
ALTERNATE
CONSTRUCTIONS

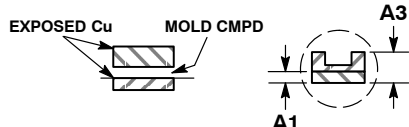

DETAIL B
ALTERNATE
CONSTRUCTIONS

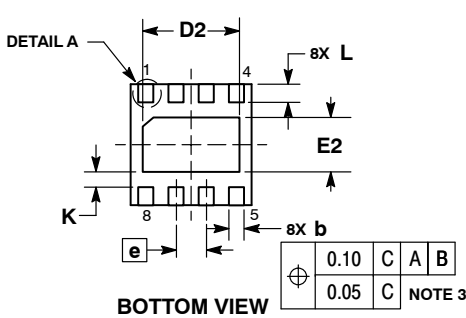

BOTTOM VIEW

- NOTES:
1. DIMENSIONING AND TOLERANCING PER ASME Y14.5M, 1994.
 2. CONTROLLING DIMENSION: MILLIMETERS.
 3. DIMENSION b APPLIES TO PLATED TERMINAL AND IS MEASURED BETWEEN 0.15 AND 0.30 MM FROM TERMINAL TIP.
 4. COPLANARITY APPLIES TO THE EXPOSED PAD AS WELL AS THE TERMINALS.

DIM	MILLIMETERS	
	MIN	MAX
A	0.70	0.80
A1	0.00	0.05
A3	0.20 REF	
b	0.20	0.30
D	2.00 BSC	
D2	1.50	1.70
E	2.00 BSC	
E2	0.80	1.00
e	0.50 BSC	
K	0.25 REF	
L	0.20	0.40
L1	---	0.15

GENERIC MARKING DIAGRAM*

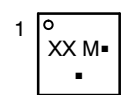

- XX = Specific Device Code
- M = Date Code
- = Pb-Free Package

(Note: Microdot may be in either location)
*This information is generic. Please refer to device data sheet for actual part marking. Pb-Free indicator, "G" or microdot "▪", may or may not be present.

RECOMMENDED SOLDERING FOOTPRINT*

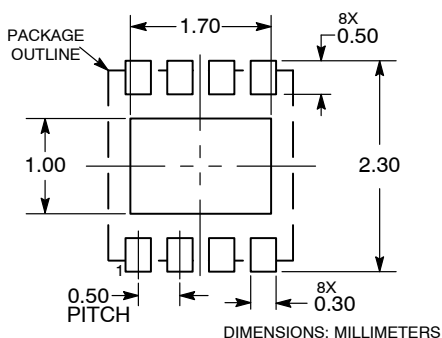

*For additional information on our Pb-Free strategy and soldering details, please download the ON Semiconductor Soldering and Mounting Techniques Reference Manual, SOLDERRM/D.

DOCUMENT NUMBER:	98AON48936E	Electronic versions are uncontrolled except when accessed directly from the Document Repository. Printed versions are uncontrolled except when stamped "CONTROLLED COPY" in red.
DESCRIPTION:	WDFN8, 2X2, 0.5P	PAGE 1 OF 1

ON Semiconductor and ON are trademarks of Semiconductor Components Industries, LLC dba ON Semiconductor or its subsidiaries in the United States and/or other countries. ON Semiconductor reserves the right to make changes without further notice to any products herein. ON Semiconductor makes no warranty, representation or guarantee regarding the suitability of its products for any particular purpose, nor does ON Semiconductor assume any liability arising out of the application or use of any product or circuit, and specifically disclaims any and all liability, including without limitation special, consequential or incidental damages. ON Semiconductor does not convey any license under its patent rights nor the rights of others.

MECHANICAL CASE OUTLINE PACKAGE DIMENSIONS

ON Semiconductor®



SCALE 2:1

WDFNW8 2x2, 0.5P CASE 511CL ISSUE B

DATE 03 DEC 2019

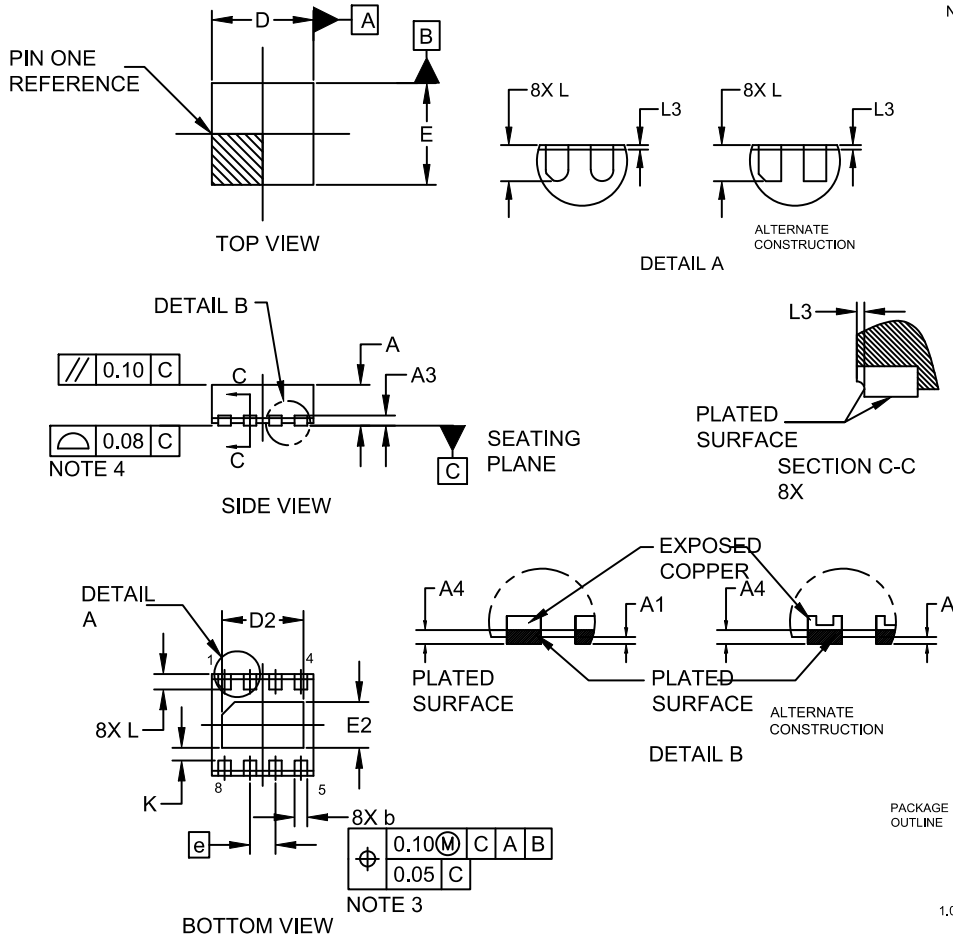

NOTES:

1. DIMENSIONING AND TOLERANCING PER ASME Y14.5M, 2009.
2. CONTROLLING DIMENSION: MILLIMETERS
3. DIMENSIONS b AND b1 APPLY TO PLATED TERMINALS AND ARE MEASURED BETWEEN 0.15 AND 0.30MM FROM THE TERMINAL TIP.
4. COPLANARITY APPLIES TO THE EXPOSED PAD AS WELL AS THE TERMINALS.

DIM	MILLIMETERS		
	MIN.	NOM.	MAX.
A	0.70	0.75	0.80
A1	0.00	---	0.05
A3	0.20 REF		
A4	0.10	---	---
b	0.20	0.25	0.30
D	1.90	2.00	2.10
D2	1.50	1.60	1.70
E	1.90	2.00	2.10
E2	0.80	0.90	1.00
e	0.50 BSC		
K	0.25 REF		
L	0.20	0.30	0.40
L3	---	---	0.10

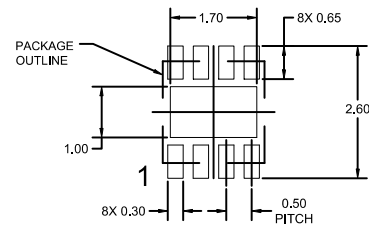

RECOMMENDED MOUNTING FOOTPRINT

* For additional information on our Pb-Free strategy and soldering details, please download the ON Semiconductor Soldering and Mounting Techniques Reference Manual, SOLDERRM/D.

GENERIC MARKING DIAGRAM*

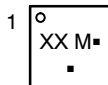

- XX = Specific Device Code
- M = Date Code
- = Pb-Free Package

(Note: Microdot may be in either location)

*This information is generic. Please refer to device data sheet for actual part marking. Pb-Free indicator, "G" or microdot "▪", may or may not be present. Some products may not follow the Generic Marking.

DOCUMENT NUMBER:	98AON12825G	Electronic versions are uncontrolled except when accessed directly from the Document Repository. Printed versions are uncontrolled except when stamped "CONTROLLED COPY" in red.
DESCRIPTION:	WDFNW8 2x2, 0.5P	PAGE 1 OF 1

ON Semiconductor and ON are trademarks of Semiconductor Components Industries, LLC dba ON Semiconductor or its subsidiaries in the United States and/or other countries. ON Semiconductor reserves the right to make changes without further notice to any products herein. ON Semiconductor makes no warranty, representation or guarantee regarding the suitability of its products for any particular purpose, nor does ON Semiconductor assume any liability arising out of the application or use of any product or circuit, and specifically disclaims any and all liability, including without limitation special, consequential or incidental damages. ON Semiconductor does not convey any license under its patent rights nor the rights of others.

onsemi, **Onsemi**, and other names, marks, and brands are registered and/or common law trademarks of Semiconductor Components Industries, LLC dba "**onsemi**" or its affiliates and/or subsidiaries in the United States and/or other countries. **onsemi** owns the rights to a number of patents, trademarks, copyrights, trade secrets, and other intellectual property. A listing of **onsemi**'s product/patent coverage may be accessed at www.onsemi.com/site/pdf/Patent-Marking.pdf. **onsemi** reserves the right to make changes at any time to any products or information herein, without notice. The information herein is provided "as-is" and **onsemi** makes no warranty, representation or guarantee regarding the accuracy of the information, product features, availability, functionality, or suitability of its products for any particular purpose, nor does **onsemi** assume any liability arising out of the application or use of any product or circuit, and specifically disclaims any and all liability, including without limitation special, consequential or incidental damages. Buyer is responsible for its products and applications using **onsemi** products, including compliance with all laws, regulations and safety requirements or standards, regardless of any support or applications information provided by **onsemi**. "Typical" parameters which may be provided in **onsemi** data sheets and/or specifications can and do vary in different applications and actual performance may vary over time. All operating parameters, including "Typicals" must be validated for each customer application by customer's technical experts. **onsemi** does not convey any license under any of its intellectual property rights nor the rights of others. **onsemi** products are not designed, intended, or authorized for use as a critical component in life support systems or any FDA Class 3 medical devices or medical devices with a same or similar classification in a foreign jurisdiction or any devices intended for implantation in the human body. Should Buyer purchase or use **onsemi** products for any such unintended or unauthorized application, Buyer shall indemnify and hold **onsemi** and its officers, employees, subsidiaries, affiliates, and distributors harmless against all claims, costs, damages, and expenses, and reasonable attorney fees arising out of, directly or indirectly, any claim of personal injury or death associated with such unintended or unauthorized use, even if such claim alleges that **onsemi** was negligent regarding the design or manufacture of the part. **onsemi** is an Equal Opportunity/Affirmative Action Employer. This literature is subject to all applicable copyright laws and is not for resale in any manner.

ADDITIONAL INFORMATION

TECHNICAL PUBLICATIONS:

Technical Library: www.onsemi.com/design/resources/technical-documentation
onsemi Website: www.onsemi.com

ONLINE SUPPORT: www.onsemi.com/support

For additional information, please contact your local Sales Representative at www.onsemi.com/support/sales

Looking for pricing, stock, or lifecycle information?

Click below to explore more details on WIN SOURCE:

 [View NCV6324BMTAAWTBG on WIN SOURCE](#)

 [ON Semiconductor](#) Information

Optimize Your Supply Chain with WIN SOURCE Solutions

-  Global Sourcing Solution
-  Obsolete Management
-  Cost Control Management
-  Shortage Management
-  Alternative Solution
-  Excess Inventory Management