



**THE DATASHEET OF
ASTMTXK-32.768KHZ-LG-T**



ECN/PCN No.: 4116

For Manufacturer			
Product Description: PLASTIC SMD MEMS OSCILLATOR	Abracon Part Number / Part Series: ASTMTXK	<input type="checkbox"/> Documentation only <input type="checkbox"/> ECN <input checked="" type="checkbox"/> EOL	<input checked="" type="checkbox"/> Series <input type="checkbox"/> Part Number
Affected Revision: A	New Revision: EOL	Application:	<input type="checkbox"/> Safety <input checked="" type="checkbox"/> Non-Safety
Prior to Change: Active https://abracon.com/Oscillators/ASTMTXK.pdf			
After Change: EOL			
Cause/Reason for Change: Discontinuation of manufacturing capability.			
Change Plan			
Effective Date: 2/7/2022	Additional Remarks: N/A		
Change Declaration: N/A			
Issued Date: 2/7/2022	Issued By: <i>Brooke Cushman Product Engineer</i>	Issued Department: Engineering	
Approval: <i>Thomas Culhane Engineering Director</i>	Approval: <i>Reuben Quintanilla Quality Director</i>	Approval: <i>Ying Huang Purchasing Director</i>	
For Abracon EOL only			
Last Time Buy (if applicable): 5/7/2022	Alternate Part Number / Part Series: none		
Additional Approval:	Additional Approval:	Additional Approval:	
Customer Approval (If Applicable)			
Qualification Status: <input type="checkbox"/> Approved <input type="checkbox"/> Not accepted <i>Note: It is considered approved if there is no feedback from the customer 1 month after ECN/PCN is released.</i>			
Customer Part Number:		Customer Project:	
Company Name:	Company Representative:	Representative Signature:	
Customer Remarks:			

Ultra-miniature, Low Power, 32.768kHz MEMS Oscillator



1.54 x 0.84 x 0.60mm

ASTMTXX



RoHS/RoHS II compliant

Moisture Sensitivity Level (MSL) – 1

FEATURES:

- Smallest 32.768kHz TCXO in the market: 1.54 x 0.84 x 0.6mm
- Supply Voltage: 1.5V to 3.63V
- Ultra-Low Current Consumption: 1.52µA max.(core current, no load)
- Frequency Stabilities include: ±5ppm, ±10ppm, ±20ppm over 0 to +70°C and -40 to +85°C
- Internal power supply filtering eliminates external bypass capacitor for V_{dd} port.

APPLICATIONS:

- Fitness/Medical monitoring sensors
- Smart Meters
- Portable devices
- RTC reference clock

STANDARD SPECIFICATIONS:

Parameters	Min	Typ	Max	Unit	Notes
Output Frequency (F _{out})	32.768			kHz	
Frequency Stability over Temperature (F _{stab}) ⁽¹⁾ (without Initial Offset ⁽²⁾)	-5		+5	ppm	Stability Option "G"
	-10		+10		Stability Option "Y"
	-20		+20		Stability Option "J"
Frequency Stability over Temperature (F _{stab}) (with Initial Offset ⁽²⁾)	-10		+10	ppm	Stability Option "G"
	-13		+13		Stability Option "Y"
	-22		+22		Stability Option "J"
Frequency Stability vs Voltage (F _{V_{dd}})	-0.75		+0.75	ppm	1.8V±10%
	-1.5		+1.5		1.5-3.63V
Aging (@+25°C)	-1		+1	ppm	First year. V _{dd} = 3.3V
Supply Voltage (V _{dd})	1.5		3.63	V	T _A = -40°C to +85°C
Core Supply Current (I _{dd}) ⁽³⁾	0.99			µA	T _A = +25°C, V _{dd} : 1.8V. LVCMOS output. No load.
	1.52				T _A = -40°C to +85°C, V _{dd} max: 1.5V - 3.63V. No load.
Power Supply Ramp (t _{V_{dd} Ramp})			100	ms	T _A = -40°C to +60°C, 0 to 90%*V _{dd}
Start-up Time at Power-up (T _{start})	180			ms	T _A = -40°C to +60°C, valid output
	300				T _A = +60°C to +70°C, valid output
	350				T _A = +70°C to +85°C, valid output
Operating Temperature Range (T _{use})	0		+70	°C	Option "N"
	-40		+85		Option "L"
Long Term Jitter			2.5	µs _{pp}	81920 cycles (2.5sec), 100 samples
Period Jitter		35		ns _{RMS}	Cycles=10000, T _A = +25°C, V _{dd} :1.5-3.63V
LVCMOS Output Option (T _A = -40°C to +85°C. Typical values are at T _A = +25°C)					
Output Rise/Fall Time (t _r /t _f)	100			ns	10-90%(V _{dd}), 15pF load
	50				10-90%(V _{dd}), 5pF load, V _{dd} ≥1.62V
Output Clock Duty Cycle	48		52	%	
Output Voltage	V _{OH}	90%*V _{dd}		V	V _{dd} :1.5-3.63V. I _{OH} = -1µA, 15pF
	V _{OL}	10%*V _{dd}			V _{dd} :1.5-3.63V. I _{OL} = 1µA, 15pF

Note:

1. No board level underfill. Measured as peak-to-peak/2. Inclusive of 3x-reflow and ±20% load variation. Tested with Agilent 53132A frequency counter. Due to the low operating frequency, the gate time must be ≥100ms to ensure an accurate frequency measurement.
2. Initial offset is defined as the frequency deviation from the ideal 32.768kHz at room temperature, past reflow.
3. Core operating current does not include output driver operating current or load current. To derive total operating current (no load), add core operating current + output driver operating current, where output driver operating current = C_{driver}*V_{out}*F_{out}.

Ultra-miniature, Low Power, 32.768kHz MEMS Oscillator



1.54 x 0.84 x 0.60mm

ASTMTXK



RoHS/RoHS II compliant

Absolute Maximum Ratings

Attempted operation outside the absolute maximum ratings may cause permanent damage to the part. Actual performance of the IC is only guaranteed within the operational specifications, not at absolute maximum ratings.

Parameters	Test Condition	Value	Unit
Continuous Power Supply Voltage Range (V_{dd})		-0.5 to 3.63	V
Short Duration Max. Power Supply Voltage (V_{dd})	≤ 30 minutes	4.0	V
Continuous Maximum Operating Temperature Range	$V_{dd}: 1.5-3.63V$	105	$^{\circ}C$
Short Duration Max. Operating Temperature Range	$V_{dd}: 1.5-3.63V, \leq 30$ minutes	125	$^{\circ}C$
Human Body Model (HBM) ESD Protection	JESD22-A114	3000	V
Charge-Device Model (CDM) ESD Protection	JESD22-C101	750	V
Machine Model (MM) ESD Protection	JESD22-A115	300	V
Latch-up Tolerance	JESD78 Compliant		
Mechanical Shock Resistance	Mil 883, Method 2002	10000	g
Mechanical Vibration Resistance	Mil 883, Method 2007	70	g
1508 CSP Junction Temperature		150	$^{\circ}C$
Storage Temperature		-65 to +150	$^{\circ}C$

Block Diagram

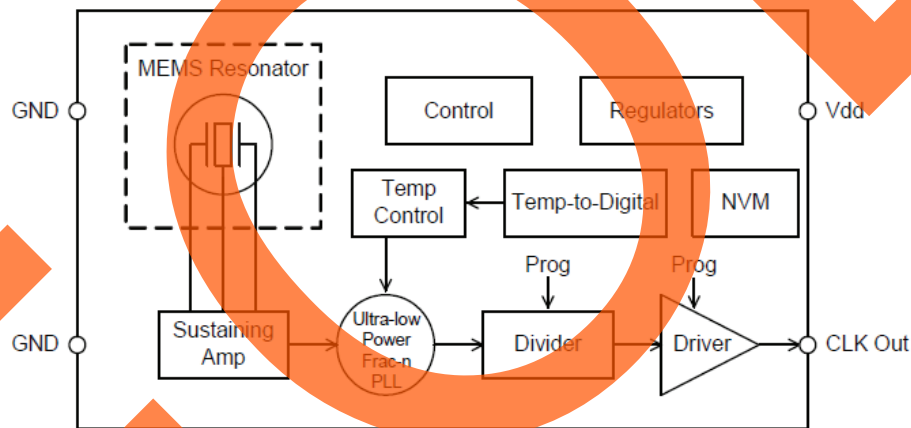

PART IDENTIFICATION:

ASTMTXK - 32.768 kHz - [] - [] - []

Operating Temp.
N: $0^{\circ}C \sim +70^{\circ}C$
L: $-40^{\circ}C \sim +85^{\circ}C$

Freq. Stability
G: $\pm 5ppm$
Y: $\pm 10 ppm$
J: $\pm 20 ppm$

Packaging
Blank: Bulk
T3: Tape & Reel (3kpcs / reel)
T10: Tape & Reel (10kpcs / reel)

Ultra-miniature, Low Power, 32.768kHz MEMS Oscillator



1.54 x 0.84 x 0.60mm

ASTMTXX



RoHS/RoHS II compliant

Typical Performance Data (TA=25°C, Vdd=1.8V, unless otherwise stated)

Frequency Stability vs. Operating Temperature Range (Pre-Reflow)

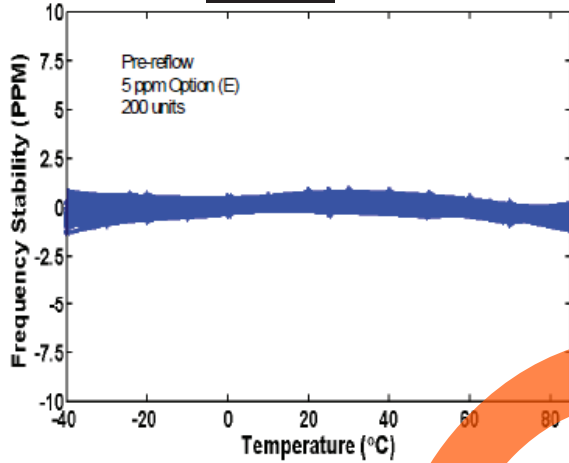

Frequency Stability vs. Operating Temperature Range (Post-Reflow)

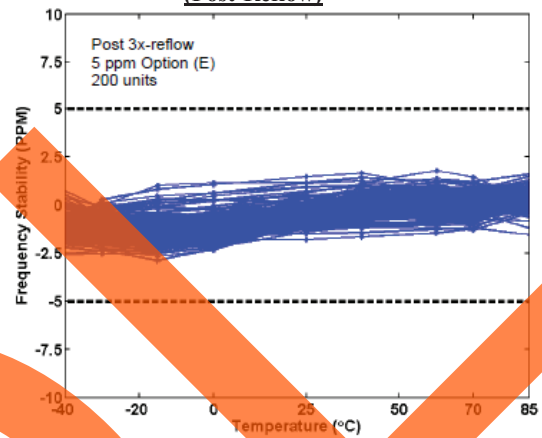

Core Current vs. Operating Temperature Range

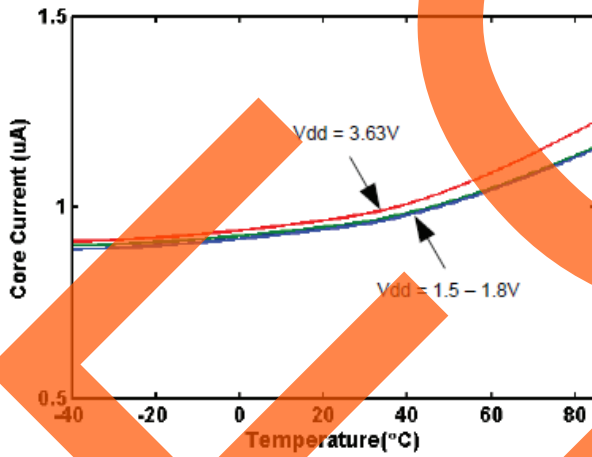

Total Supply Current vs. Operating Temperature Range (Core+LVCMOS Output Driver, No Load)

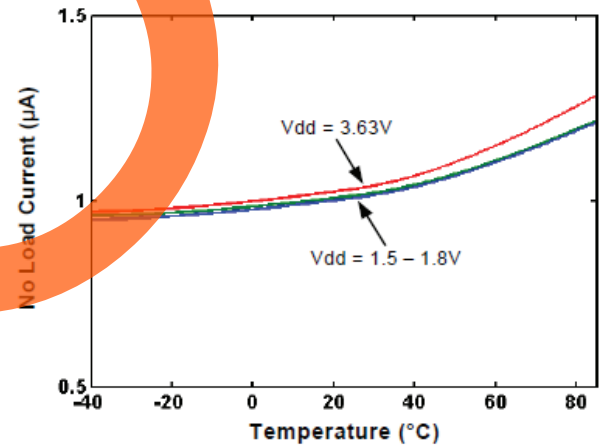

Start-up and Steady-State Current Profile

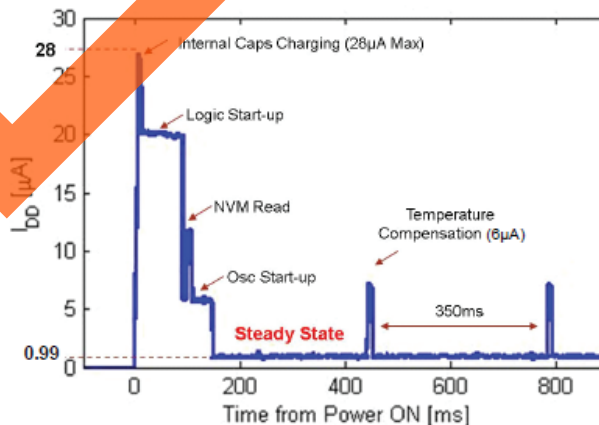

Ultra-miniature, Low Power, 32.768kHz MEMS Oscillator



1.54 x 0.84 x 0.60mm

ASTMTXX



RoHS/RoHS II compliant

PART IDENTIFICATION:

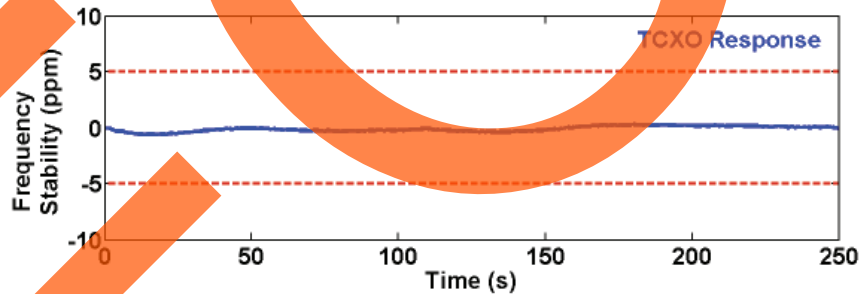
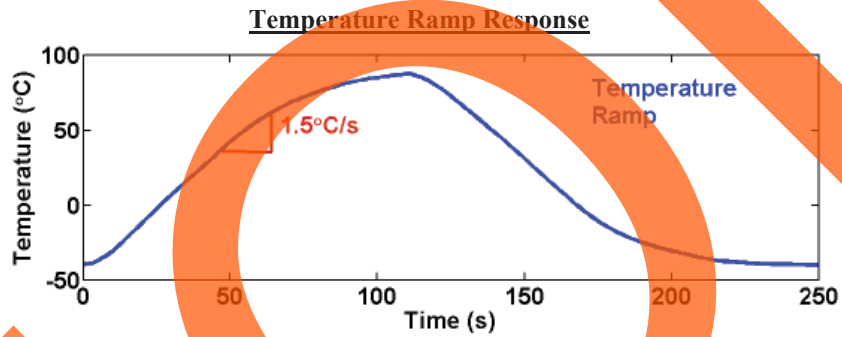
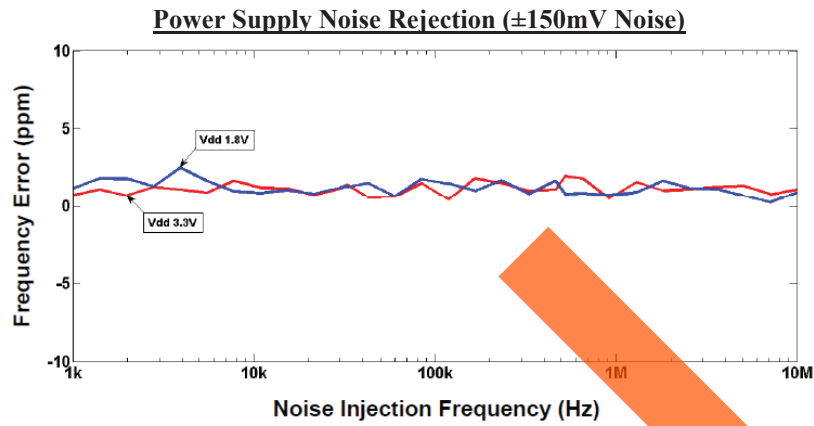

LVC MOS Output Waveform

($V_{\text{swing}} = 1.8\text{V}$, 10pF load)

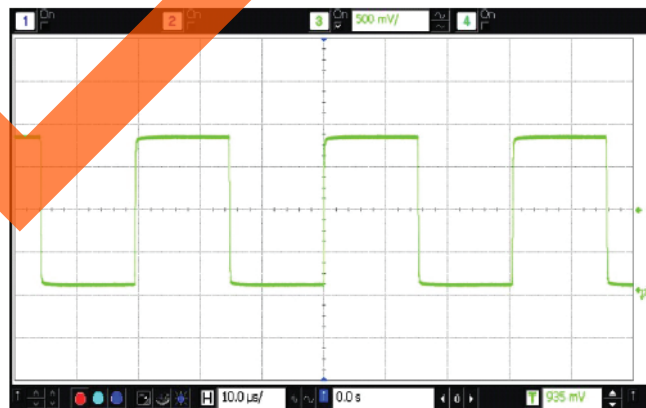

Ultra-miniature, Low Power, 32.768kHz MEMS Oscillator



1.54 x 0.84 x 0.60mm

ASTMTXX



RoHS/RoHS II compliant

OUTLINE DIMENSION:

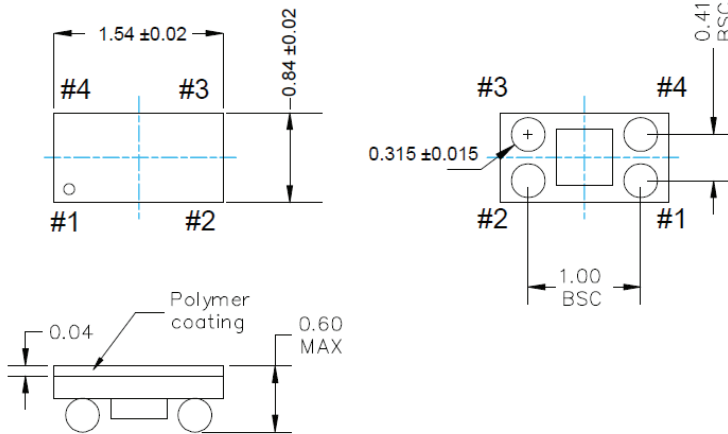

Recommended Land Pattern

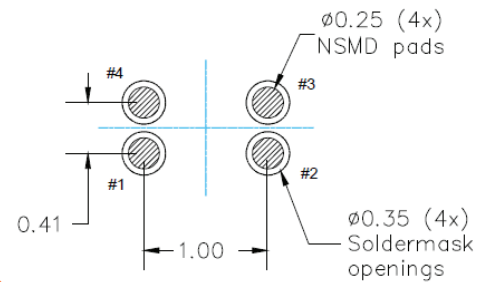

(soldermask openings shown with heavy dashed line)

Recommend 4-mil (0.1mm) stencil thickness

Pin	Name	I/O	Functionality
1,4	GND	Power Supply Ground	Connect to ground. All GND pins must be connected to power supply ground. The GND pins can be connected together, as long as both GND pins are connected to ground.
2	CLK Out	OUT	Oscillator clock output.
3	V _{dd}	Power Supply	Connect to power supply $1.5V \leq V_{dd} \leq 3.63V$. Under normal operating conditions, V _{dd} doesn't require external bypass/decoupling capacitor(s). Internal power supply filtering will reject more than $\pm 150mV_{pp}$ with frequency components through 10MHz.

Dimensions: mm

REFLOW PROFILE:

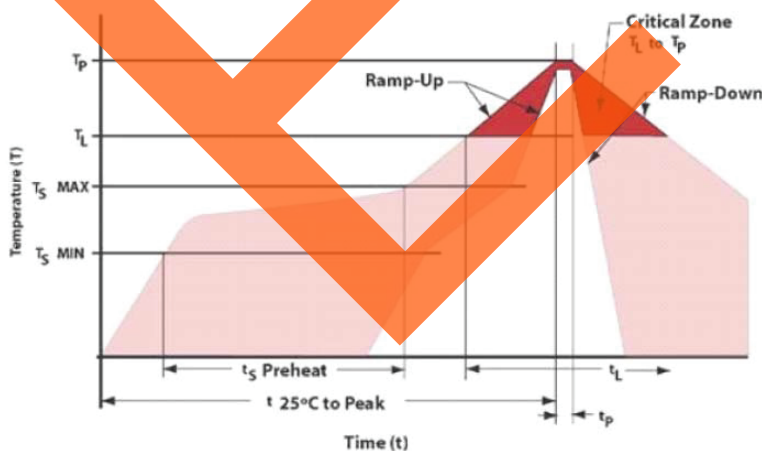

Item	Conditions
T _S MAX to T _L (Ramp-up Rate)	3°C/second max
Preheat	
Temperature Minimum (T _S MIN)	150°C
Temperature Typical (T _S TYP)	175°C
Temperature Maximum (T _S MAX)	200°C
Time (t _s)	60 – 180 seconds
Ramp-up Rate (T _L to T _P)	3°C/second max
Time Maintained Above	
Temperature (T _L)	217°C
Time (t _L)	60 – 150 seconds
Peak Temperature (T _P)	260°C max
Target Peak Temperature (T _P Target)	255°C
Time within 5°C of actual peak (t _p)	20 – 40 seconds
Max. Number of Reflow Cycles	3
Ramp-down Rate	6°C/second max
Time 25°C to Peak Temperature (t)	8 minutes max

Ultra-miniature, Low Power, 32.768kHz MEMS Oscillator



1.54 x 0.84 x 0.60mm

ASTMTXX



RoHS/RoHS II compliant

TAPE & REEL:

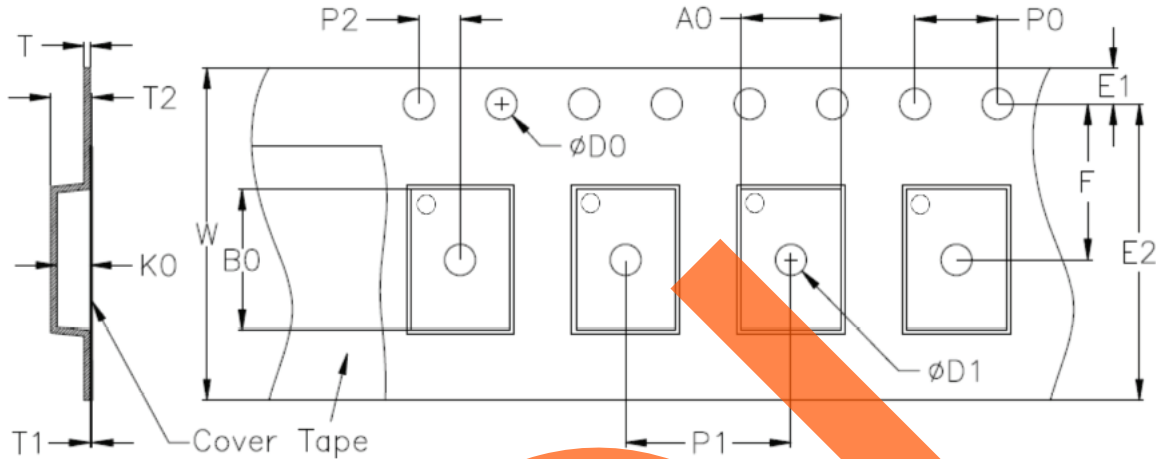

Unit: mm

D0	D1 min.	E1	E2 min.	F	P0	P1	P2
1.55±0.05	0.18	1.75±0.1	6.05	3.5±0.05	4.0±0.1	4.0±0.1	2.0±0.05
T	T1 max.	T2 max.	W max.	A0	B0	K0	
0.20±0.02	0.1	1.55	8.3	0.96±0.03	1.66±0.03	0.63±0.03	

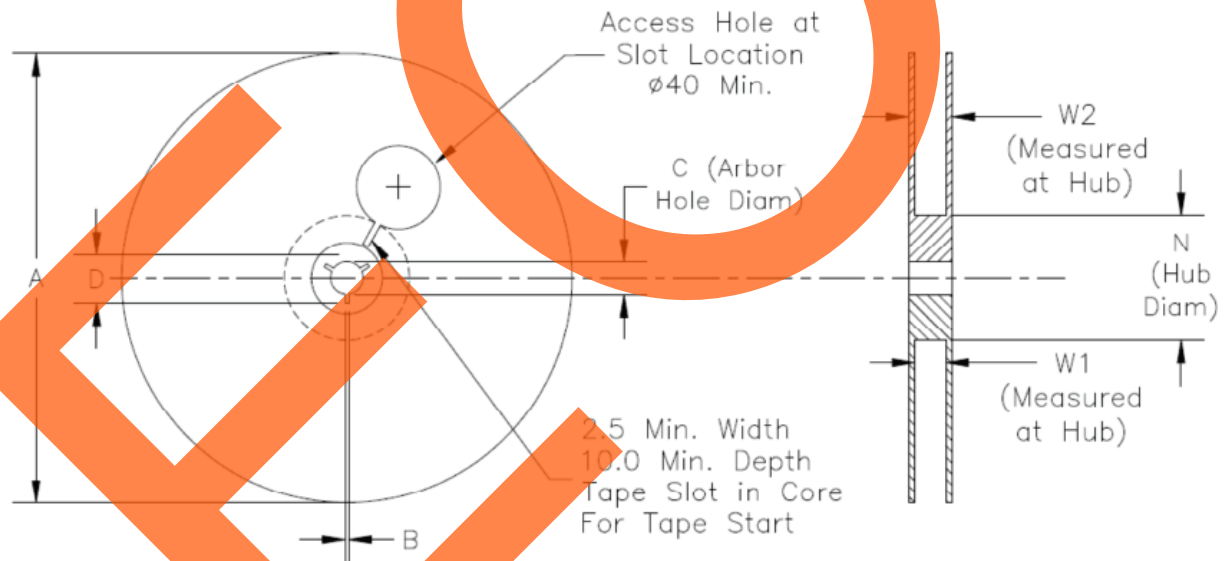

Unit: mm

Option	A max.	B min.	C	D min.	N	W1	W2 max.
T3	180	1.5	13.0+0.6/-0.2	20.2	60±0.5	8.4+1.5/-0	14.4
T10	330	1.5	13.0±0.2	20.2	100±0.5	8.4+1.5/-0	14.4

T3= Tape and reel (3,000pcs/reel)

T10= Tape and reel (10,000pcs/reel)

ATTENTION: Abracon LLC's products are COTS – Commercial-Off-The-Shelf products; suitable for Commercial, Industrial and, where designated, Automotive Applications. Abracon's products are not specifically designed for Military, Aviation, Aerospace, Life-dependent Medical applications or any application requiring high reliability where component failure could result in loss of life and/or property. For applications requiring high reliability and/or presenting an extreme operating environment, written consent and authorization from Abracon LLC is required. Please contact Abracon LLC for more information.



5101 Hidden Creek Ln Spicewood TX 78669
 Phone: 512-371-6159 | Fax: 512-351-8858
 For terms and conditions of sales, please visit:
www.abracon.com

REVISED: 05.27.2021

ABRACON IS
 ISO9001-2015
 CERTIFIED

Looking for pricing, stock, or lifecycle information?

Click below to explore more details on WIN SOURCE:

- ⊖ [View ASTM TXK-32.768KHZ-LG-T on WIN SOURCE](#)
- ⊖ [Abracon LLC Information](#)

Optimize Your Supply Chain with WIN SOURCE Solutions

- ✓ Global Sourcing Solution
- ✓ Obsolete Management
- ✓ Cost Control Management
- ✓ Shortage Management
- ✓ Alternative Solution
- ✓ Excess Inventory Management