



# INDUSTRIAL GRADE PLASTIC PACKAGE ULTRA MINIATURE PURE SILICON™ CLOCK OSCILLATOR

**ASFLMB**

Request Samples 

Check Inventory 



5.0 x 3.2 x 0.85 mm  
**RoHS/RoHS II Compliant**  
 MSL Level = 1

## Features

- Low Power Consumption <10mA
- Exceptional Stability +/- 10ppm Over Temp. at -40 to +105°C
- Compact QFN Plastic Packaging

## Applications

- CCD Clock for VTR Camera
- Equipment Connected to PCs
- Low Profile Equipment
- Computers and Peripherals
- Portable Electronics
- Consumer Electronics
- Vibrant, Shock-Prone & Humid Environments for Industrial Equipment
- Demanding Military & Automotive Electronics

## Key Electrical Specifications

Parameters	Min.	Typ.	Max.	Units	Notes
Frequency Range	1.0		150	MHz	
Operating Temperature	0		+70	°C	See options
Storage Temperature	-55		+150	°C	
Overall Frequency Stability*:	-50		+50	ppm	See options
Supply Voltage (Vdd):	+1.8 ~ +3.3			V	
Output Load:			15, 25, or 40	pF	See options
	10			kΩ	
Symmetry:	45		55	%	@1/2Vdd
Startup Time:		1.5	3.0	ms	
Disable Time:		20	100	ns	
Disable Stand-by Current:			15	uA	
Tri-state Function (Stand-by) :	"1" (VIH≥0.75*Vdd) or Open: Oscillation "0" (VIL<0.25*Vdd) : Hi Z			V	
Aging:	-5.0		+5.0	ppm	First year



5101 Hidden Creek Ln Spicewood TX 78669  
 Phone: 512-371-6159 | Fax: 512-351-8858  
 For terms and conditions of sales, please visit:  
[www.abracon.com](http://www.abracon.com)

REVISED: 09-21-23

ABRACON IS  
 ISO9001-2015  
 CERTIFIED

# INDUSTRIAL GRADE PLASTIC PACKAGE ULTRA MINIATURE PURE SILICON™ CLOCK OSCILLATOR

**ASFLMB**

Request Samples



Check Inventory



ESD Sensitive



5.0 x 3.2 x 0.85 mm

RoHS/RoHS II Compliant

MSL Level = 1

## Key Electrical Specifications– $V_{dd} = 1.8V$

Parameters		Min.	Typ.	Max.	Units	Notes
Supply Current (no load):	1.0 to 39.9999MHz		5	15	mA	CL=0p RL=∞ T=25°C (Standard CL: 15pF)
	40.0 to 79.9999MHz		6	15	mA	
	80.0 to 124.9999MHz		7	15	mA	
	125.0 to 150MHz		8	15	mA	
	1.0 to 39.9999MHz		6	15	mA	CL=0p RL=∞ T=25°C (CL option: 25pF)
	40.0 to 79.9999MHz		7	15	mA	
	80.0 to 124.9999MHz		8	15	mA	
	125.0 to 150MHz		9	15	mA	
	1.0 to 39.9999MHz		7	15	mA	CL=0p RL=∞ T=25°C (CL option: 40pF)
	40.0 to 79.9999MHz		8	15	mA	
	80.0 to 124.9999MHz		9	15	mA	
	125.0 to 150MHz		10	15	mA	
Output Voltage:	$V_{OH}$	$0.8 * V_{dd}$			V	CL=15, 25, 40pF
	$V_{OL}$			$0.2 * V_{dd}$	V	
Rise Time: Fall Time:	$T_r$		1.8	3.0	ns	CL=15pF; T=25°C 20%/80%*VDD
	$T_f$		1.0	3.0	ns	
	$T_r$		1.5	3.0	ns	CL=25pF; T=25°C 20%/80%*VDD
	$T_f$		1.2	3.0	ns	
	$T_r$		1.4	3.0	ns	CL=40pF; T=25°C 20%/80%*VDD
	$T_f$		1.1	3.0	ns	
Cycle to Cycle Jitter:			60		ps	F=100MHz
Period Jitter RMS:			10		ps	F=100MHz

# INDUSTRIAL GRADE PLASTIC PACKAGE ULTRA MINIATURE PURE SILICON™ CLOCK OSCILLATOR

**ASFLMB**

Request Samples



Check Inventory



ESD Sensitive



5.0 x 3.2 x 0.85 mm

RoHS/RoHS II Compliant

MSL Level = 1

## Key Electrical Specifications– $V_{dd} = 2.5V$

Parameters		Min.	Typ.	Max.	Units	Notes
Supply Current (no load):	1.0 to 39.9999MHz		6	15	mA	CL=0p RL=∞ T=25°C (Standard CL: 15pF)
	40.0 to 79.9999MHz		7	15	mA	
	80.0 to 124.9999MHz		8	15	mA	
	125.0 to 150MHz		9	15	mA	
	1.0 to 39.9999MHz		7	15	mA	CL=0p RL=∞ T=25°C (CL option: 25pF)
	40.0 to 79.9999MHz		8	15	mA	
	80.0 to 124.9999MHz		9	15	mA	
	125.0 to 150MHz		10	15	mA	
	1.0 to 39.9999MHz		8	16	mA	CL=0p RL=∞ T=25°C (CL option: 40pF)
	40.0 to 79.9999MHz		9	16	mA	
	80.0 to 124.9999MHz		10	16	mA	
	125.0 to 150MHz		11	16	mA	
Output Voltage:	$V_{OH}$	$0.8 * V_{dd}$			V	CL=15, 25pF
	$V_{OL}$			$0.2 * V_{dd}$	V	
	$V_{OH}$	$0.9 * V_{dd}$			V	
	$V_{OL}$			$0.1 * V_{dd}$	V	
Rise Time: Fall Time:	$T_r$		1.0	2.0	ns	CL=15pF; T=25°C 20%/80%*VDD
	$T_f$		0.9	2.0	ns	
	$T_r$		1.1	2.0	ns	CL=25pF; T=25°C 20%/80%*VDD
	$T_f$		0.9	2.0	ns	
	$T_r$		1.0	2.0	ns	CL=40pF; T=25°C 20%/80%*VDD
	$T_f$		0.9	2.0	ns	
Cycle to Cycle Jitter:			50		ps	F=100MHz
Period Jitter RMS:			5		ps	F=100MHz

# INDUSTRIAL GRADE PLASTIC PACKAGE ULTRA MINIATURE PURE SILICON™ CLOCK OSCILLATOR

**ASFLMB**

Request Samples

Check Inventory



**5.0 x 3.2 x 0.85 mm**  
**RoHS/RoHS II Compliant**  
**MSL Level = 1**

## Key Electrical Specifications– Vdd = 3.3V

Parameters		Min.	Typ.	Max.	Units	Notes
Supply Current (no load):	1.0 to 39.9999MHz		7	15	mA	CL=0p RL=∞ T=25°C (Standard CL: 15pF)
	40.0 to 79.9999MHz		8	15	mA	
	80.0 to 124.9999MHz		9	15	mA	
	125.0 to 150MHz		10	15	mA	
	1.0 to 39.9999MHz		8	16	mA	CL=0p RL=∞ T=25°C (CL option: 25pF)
	40.0 to 79.9999MHz		9	16	mA	
	80.0 to 124.9999MHz		10	16	mA	
	125.0 to 150MHz		11	16	mA	
	1.0 to 39.9999MHz		8	16	mA	CL=0p RL=∞ T=25°C (CL option: 40pF)
	40.0 to 79.9999MHz		9	16	mA	
	80.0 to 124.9999MHz		10	16	mA	
	125.0 to 150MHz		11	16	mA	
Output Voltage:	V <sub>OH</sub>	0.8*V <sub>dd</sub>			V	CL=15pF
	V <sub>OL</sub>			0.2*V <sub>dd</sub>	V	
	V <sub>OH</sub>	0.9*V <sub>dd</sub>			V	CL=25, 40pF
	V <sub>OL</sub>			0.1*V <sub>dd</sub>	V	
Rise Time: Fall Time:	Tr		1.0	2.0	ns	CL=15pF; T=25°C 20%/80%*VDD
	Tf		0.9	2.0	ns	
	Tr		1.0	2.0	ns	CL=25pF; T=25°C 20%/80%*VDD
	Tf		0.9	2.0	ns	
	Tr		0.8	2.0	ns	CL=40pF; T=25°C 20%/80%*VDD
	Tf		0.8	2.0	ns	
Cycle to Cycle Jitter:			50		ps	F=100MHz
Period Jitter RMS:			5		ps	F=100MHz

## Absolute Maximum Ratings

Parameters	Min.	Max.	Units	Condition
Supply Voltage	-0.3	+4.0	V	
Input Voltage	-0.3	Vdd+0.3	V	
Junction Temp.		+150	°C	
Storage Temp.	-55	+150	°C	
Soldering Temp.		+260	°C	40sec max
ESD			V	
HBM		4,000		
MM		200		
CDM		1,500		



5101 Hidden Creek Ln Spicewood TX 78669  
 Phone: 512-371-6159 | Fax: 512-351-8858  
 For terms and conditions of sales, please visit:  
[www.abracon.com](http://www.abracon.com)

**REVISED: 09-21-23**

ABRACON IS  
 ISO9001-2015  
 CERTIFIED

# INDUSTRIAL GRADE PLASTIC PACKAGE ULTRA MINIATURE PURE SILICON™ CLOCK OSCILLATOR

**ASFLMB**

Request Samples 

Check Inventory 



5.0 x 3.2 x 0.85 mm  
**RoHS/RoHS II Compliant**  
 MSL Level = 1

## Options and Part Identification (left blank if standard)

ASFLMB-  MHz-   -  -

Frequency in MHz
e.g. 14.3181 MHz (Maximum 4 digits after decimal)

Operating Temp.
Blank: 0°C ~ +70°C
E: -20°C ~ +70°C
L: -40°C ~ +85°C
X: -40°C ~ +105°C

Overall Freq. Stability
C: ±50ppm (STD)
Y: ±10ppm
R: ±25 ppm

Output Load
Blank: 15pF
25: 25pF
40: 40pF

Packaging
Blank: 72pcs / Tube
T: 1,000pcs / reel



5101 Hidden Creek Ln Spicewood TX 78669  
 Phone: 512-371-6159 | Fax: 512-351-8858  
 For terms and conditions of sales, please visit:  
[www.abracon.com](http://www.abracon.com)

**REVISED: 09-21-23**

ABRACON IS  
 ISO9001-2015  
 CERTIFIED

ASFLMB

Request Samples



Check Inventory



ESD Sensitive



5.0 x 3.2 x 0.85 mm  
RoHS/RoHS II Compliant  
MSL Level = 1

**Mechanical Dimensions**

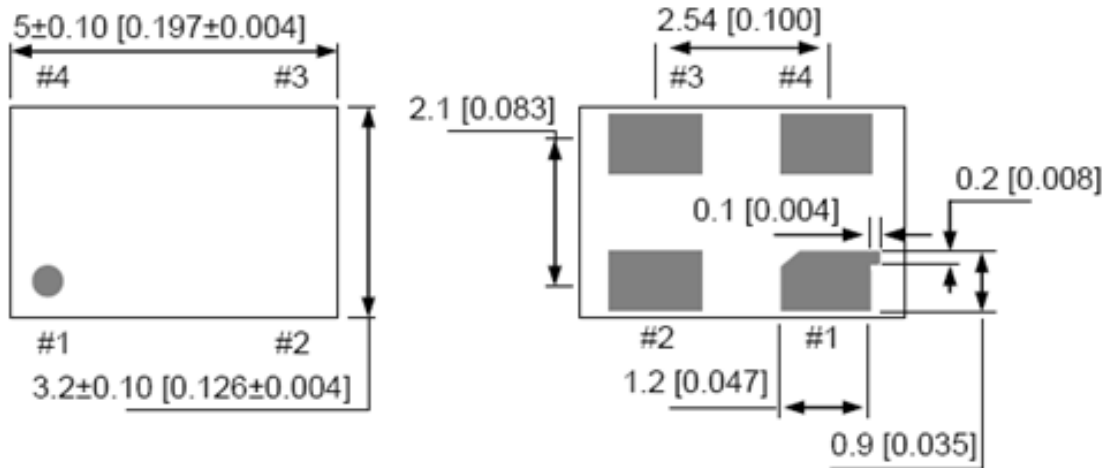

No.	Pin Terminal
1	Standby#
2	GND
3	Output
4	VDD

**Recommended Land Pattern**

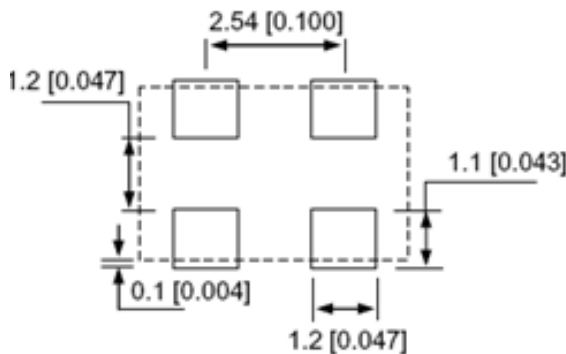

Note: Recommend using an approximately 0.01uF bypass capacitor between PIN 2 and 4

Dimensions: mm (inches)



5101 Hidden Creek Ln Spicewood TX 78669  
Phone: 512-371-6159 | Fax: 512-351-8858  
For terms and conditions of sales, please visit:  
www.abracon.com

REVISED: 09-21-23

ABRACON IS  
ISO9001-2015  
CERTIFIED

ASFLMB

Request Samples

Check Inventory



5.0 x 3.2 x 0.85 mm  
RoHS/RoHS II Compliant  
MSL Level = 1

Reflow Profile [JEDEC J-STD-020]

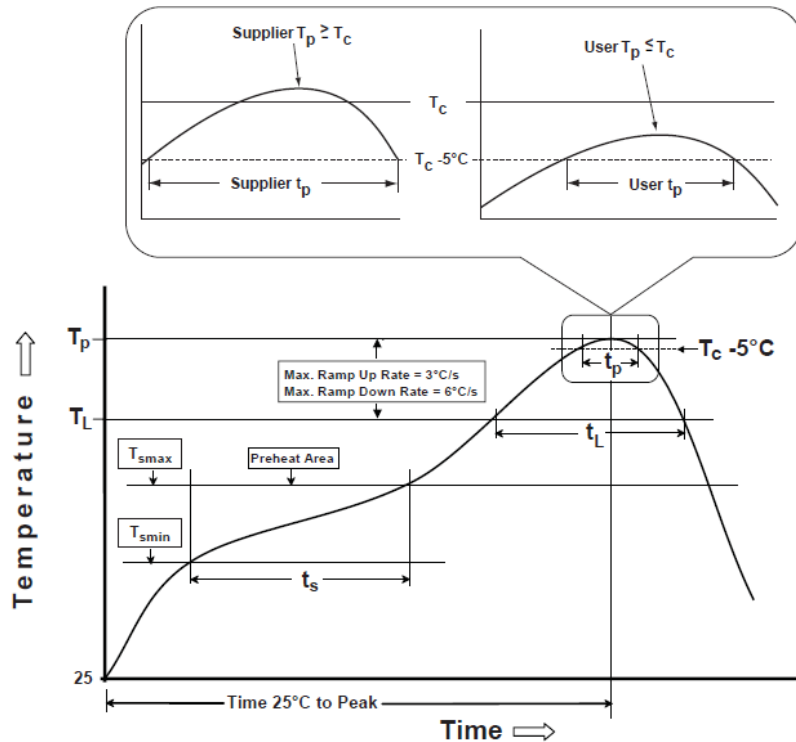

Table 1

SnPb Eutectic Process  
Classification Temperatures ( $T_c$ )

Package Thickness	Volume mm <sup>3</sup> <350	Volume mm <sup>3</sup> ≥350
<2.5 mm	235 °C	220 °C
≥2.5 mm	220 °C	220 °C

Table 2

Pb-Free Process  
Classification Temperatures ( $T_c$ )

Package Thickness	Volume mm <sup>3</sup> <350	Volume mm <sup>3</sup> 350-2000	Volume mm <sup>3</sup> >2000
<1.6 mm	260 °C	260 °C	260 °C
1.6 mm - 2.5 mm	260 °C	250 °C	245 °C
>2.5 mm	250 °C	245 °C	245 °C

Profile Feature	Sn-Pb Eutectic Assembly	Pb-Free Assembly
Preheat / soak		
Temperature minimum ( $T_{smin}$ )	100°C	150°C
Temperature maximum ( $T_{smax}$ )	150°C	200°C
Time ( $T_{smin}$ to $T_{smax}$ ) ( $t_s$ )	60 - 120 sec.	60 - 120 sec.
Average ramp-up rate ( $T_{smax}$ to $T_p$ )	3°C/sec. max	3°C/sec. max
Liquidous temperature ( $T_L$ )	183°C	217°C
Time at liquidous ( $t_L$ )	60 - 150 sec.	60 - 150 sec.
Peak package body temperature ( $T_p$ )*	see Table 1	see Table 2
Time ( $t_p$ )** within 5°C of the specified classification temperature ( $T_c$ )	20 sec.	30 sec.
Ramp-down rate ( $T_p$ to $T_{smax}$ )	6°C/sec. max	6°C/sec. max
Time 25°C to peak temperature	6 min. max	8 min. max
Reflow cycles	2 max	2 max

\*Tolerance for peak profile temperature ( $T_p$ ) is defined as a supplier minimum and a user maximum.

\*\*Tolerance for time at peak profile temperature ( $t_p$ ) is defined as supplier minimum and a user maximum.



5101 Hidden Creek Ln Spicewood TX 78669  
Phone: 512-371-6159 | Fax: 512-351-8858  
For terms and conditions of sales, please visit:  
www.abracon.com

REVISED: 09-21-23

ABRACON IS  
ISO9001-2015  
CERTIFIED

# INDUSTRIAL GRADE PLASTIC PACKAGE ULTRA MINIATURE PURE SILICON™ CLOCK OSCILLATOR

**ASFLMB**

Request Samples



Check Inventory



ESD Sensitive



5.0 x 3.2 x 0.85 mm  
 RoHS/RoHS II Compliant  
 MSL Level = 1

## Packaging

T = 1,000pcs/reel (D=180mm)

Tape 1

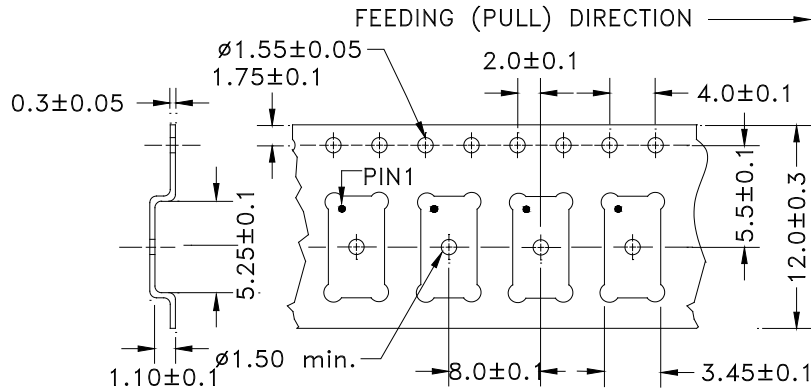

Tape 2

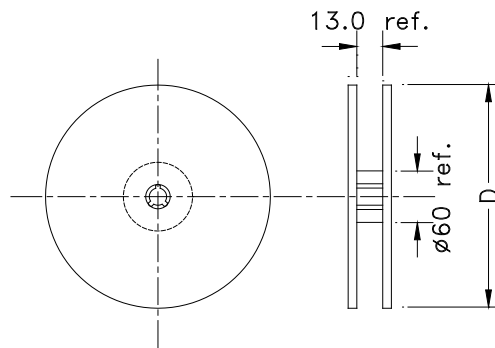
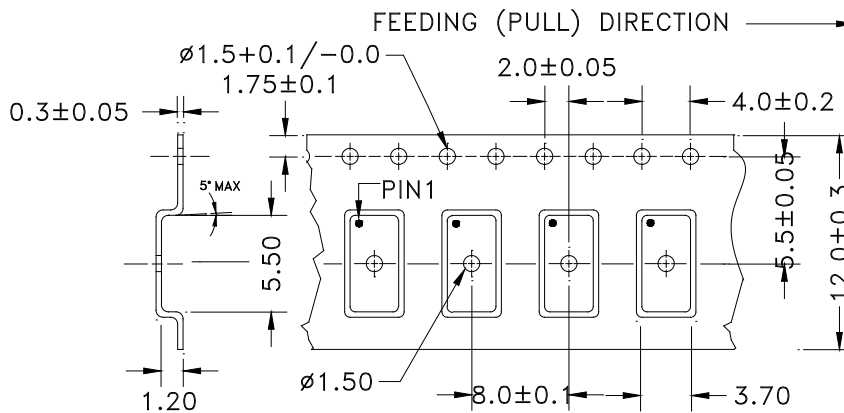

# INDUSTRIAL GRADE PLASTIC PACKAGE ULTRA MINIATURE PURE SILICON™ CLOCK OSCILLATOR

ASFLMB

Request Samples



Check Inventory



ESD Sensitive



5.0 x 3.2 x 0.85 mm  
RoHS/RoHS II Compliant  
MSL Level = 1

Tube: 72 pcs/tube

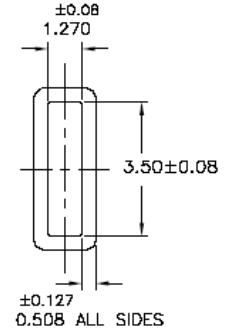
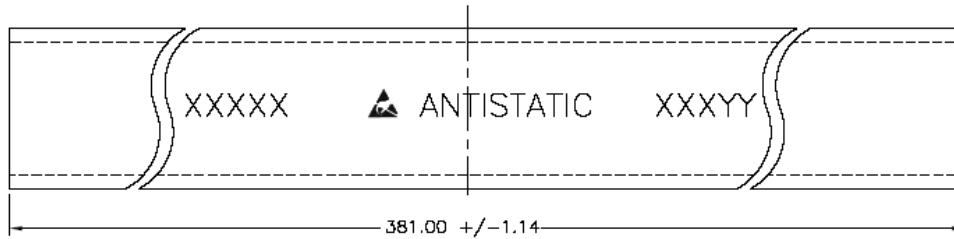

Unit orientation in tube:



Dimensions: mm

**ATTENTION:** Abracon LLC's products are COTS – Commercial-Off-The-Shelf products; suitable for Commercial, Industrial and, where designated, Automotive Applications. Abracon's products are not specifically designed for Military, Aviation, Aerospace, Life-dependent Medical applications or any application requiring high reliability where component failure could result in loss of life and/or property. For applications requiring high reliability and/or presenting an extreme operating environment, written consent and authorization from Abracon LLC is required. Please contact Abracon LLC for more information.



5101 Hidden Creek Ln Spicewood TX 78669  
Phone: 512-371-6159 | Fax: 512-351-8858  
For terms and conditions of sales, please visit:  
[www.abracon.com](http://www.abracon.com)

REVISED: 09-21-23

ABRACON IS  
ISO9001-2015  
CERTIFIED

## Looking for pricing, stock, or lifecycle information?

Click below to explore more details on WIN SOURCE:

- ⊖ [View ASFLMB-33.333MHZ-LY-T on WIN SOURCE](#)
- ⊖ [Abracon LLC Information](#)

## Optimize Your Supply Chain with WIN SOURCE Solutions

- ✓ Global Sourcing Solution
- ✓ Obsolete Management
- ✓ Cost Control Management
- ✓ Shortage Management
- ✓ Alternative Solution
- ✓ Excess Inventory Management