



**THE DATASHEET OF
EBM22DRXN**





.156" [3.96 mm] Contact Centers, .431" [10.95 mm] Insulator Height, Dip Solder/Eyelet/Right Angle

SPECIFICATIONS

- Accommodates .062" ± .008" [1.57 mm ± 0.20 mm] PC board
- Molded-in key available
- 3 Amps current rating for one contact energized (for 5 Amps application, consult factory)
- 30 milli Ohms maximum at rated current
- UL Flammability Rating: 94V-0

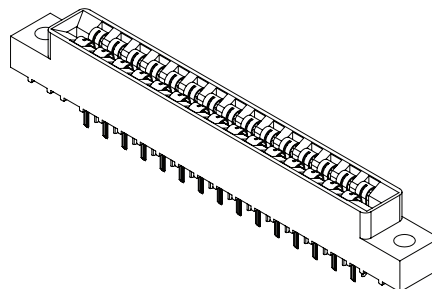

READOUT

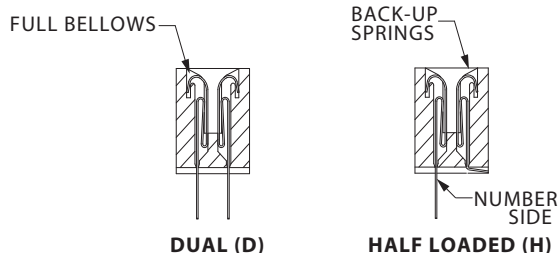

POLARIZING KEY

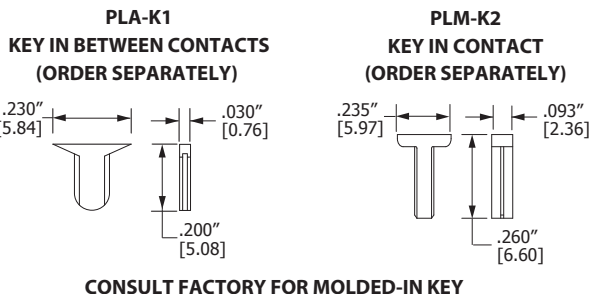

TERMINATION TYPE

EYELET ACCEPTS 3-#22 AWG



ALTERNATE EYELET SHAPE * (RE) .014" [0.36] THICK

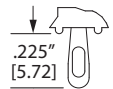

(SE) .007" [0.18] THICK (RE) .014" [0.36] THICK

EYELET (SE OR RE)

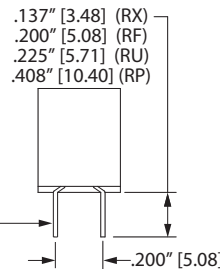
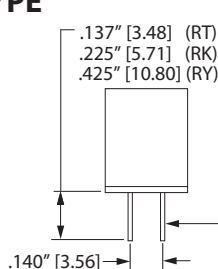

(RA) .125" [3.18] FOR ALL POSITIONS
 (SA) .270" [6.85] 02 THRU 25 POSITIONS
 (SA) .230" [5.84] 28 THRU 36 POSITIONS
 (SA) .190" [4.82] 43 POSITIONS
 TOLERANCE: (RA) ± .025" [0.64]
 (SA) ± .040" [1.00]

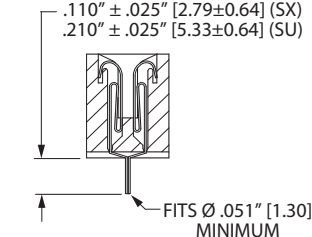
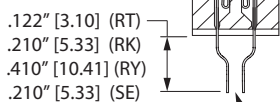
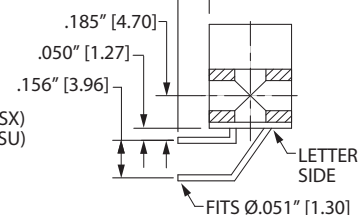

MOUNTING STYLE

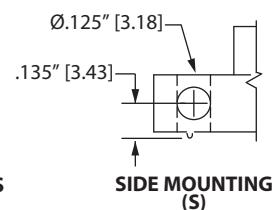
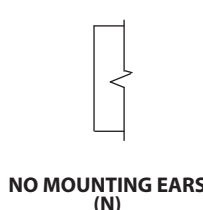
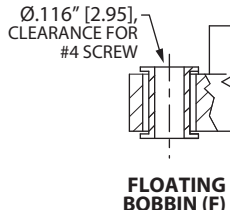
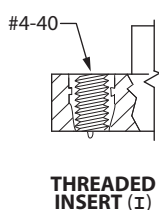
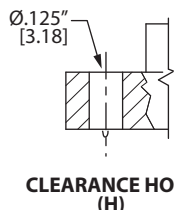

* Beryllium Copper & Beryllium Nickel (H, A, J, F, C & W Material Codes) Only.



.156" [3.96 mm] Contact Centers, .431" [10.95 mm] Insulator Height, Dip Solder/Eyelet/Right Angle

PART NUMBER OPTIONS

MATERIALS (INSULATOR/CONTACT)

- E = PBT/Phosphor Bronze (Standard)
- R = PPS/Phosphor Bronze
- G = PA9T/Phosphor Bronze
- H = PBT/Beryllium Copper
- A = PPS/Beryllium Copper
- J = PA9T/Beryllium Copper
- *F = PPS/Spinodal (Overall Gold Plating Only)
Consult Factory for Special Soldering Guidelines
- *C = PPS/Beryllium Nickel (Overall Gold Plating Only)
- *W = PEEK/Beryllium Nickel (Overall Gold Plating Only)
- *Consult factory for availability.
- Refer to Page 7 for Operating/Processing Temperatures

CONTACT FINISH - RoHS Compliant

All platings are Lead Free and have .000050" Nickel underplate

Contact Surface	Termination
B = .000010" Gold	.000100" Pure Tin, Matte
C = .000030" Gold	.000100" Pure Tin, Matte
G = .000010" Gold	.000005" Gold
Y = .000030" Gold	.000005" Gold
Contact Surface	Overall Plating
S = .000010" Gold	.000010" Gold
M = .000030" Gold	.000010" Gold
E = .000100" Pure Tin, Matte	.000100" Pure Tin, Matte

CONTACT CENTERS

M = .156" [3.96 mm]

NUMBER OF CONTACT POSITIONS

See Chart Below

E B M 43 D RK H - Sxxx

MODIFICATION CODE (Consult Factory)
OMIT FOR STANDARD

-S13 = Card Extender Accepts .062" [1.57 mm] PCB
(RT, RK, RY, SE Terminations Only)

MOUNTING STYLE (Opposite Page)

- H = .125" [3.18 mm] Clearance Holes
- N = No Mounting
- S = Side Mounting
- I = Threaded Insert
- F = Floating Bobbin

TERMINATION TYPE (Opposite Page)

- RA = .125" [3.18 mm] Right Angle Dip Solder
- SA = Long Right Angle Dip Solder
- RT = .140" X .137" [3.56 mm X 3.48 mm] Dip Solder
- RK = .140" X .225" [3.56 mm X 5.72 mm] Dip Solder
- RY = .140" X .425" [3.56 mm X 10.80 mm] Dip Solder
- RX = .200" X .137" [5.08 mm X 3.48 mm] Dip Solder
- RF = .200" X .200" [5.08 mm X 5.08 mm] Dip Solder
- RU = .200" X .225" [5.08 mm X 5.72 mm] Dip Solder
- RP = .200" X .408" [5.08 mm X 10.36 mm] Dip Solder
- SX = .110" [2.79 mm] Centered Dip Solder
- SU = .210" [5.33 mm] Centered Dip Solder
- SE = .007" [0.18 mm] Thick Eyelet
- RE = .014" [0.36 mm] Thick Eyelet

READOUT (Opposite Page)

- D = Dual
- D = Dual Row/ Crimp to Center for
Single Readout (SX, SU Termination Only)
- H = Half Loaded

DIMENSIONS Dimensions in [] are in millimeters, all others are in inches.

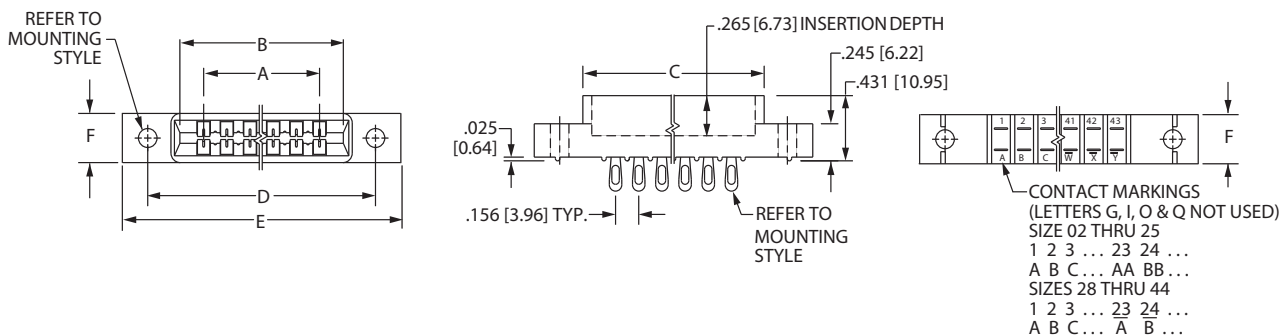

Tolerances on non-critical dimensions may vary slightly due to shrinkage differential per insulator material; Consult factory.

POSITIONS/ CONTACTS	INCHES						MILLIMETERS					
	A±.008	B±.008	C±.015	D±.010	E MAX	F+.005/-0.015	A±0.20	B±0.20	C±0.38	D±0.25	E MAX	F+0.13/-0.38
02/04	0.156	0.476	0.596	'N' MOUNTING			3.96	12.09	15.14	'N' MOUNTING		
03/06	0.312	0.632	0.752				7.92	16.05	19.10			
04/08*	0.468	0.788	0.908				11.89	20.02	23.06			
06/12	0.780	1.100	1.220	1.533	1.902	0.325	19.81	27.94	30.99	38.94	48.31	8.26
07/14	0.936	1.256	1.376	1.689	2.058		23.77	31.90	34.95	42.90	52.27	
08/16	1.092	1.412	1.532	1.845	2.214		27.74	35.86	38.91	46.86	56.24	
10/20	1.404	1.724	1.844	2.157	2.526		35.66	43.79	46.84	54.79	64.16	
11/22	1.560	1.880	2.000	2.313	2.682		39.62	47.75	50.80	58.75	68.12	
12/24	1.716	2.036	2.156	2.469	2.838		43.59	51.71	54.76	62.71	72.09	
15/30	2.184	2.504	2.624	2.937	3.306		55.47	63.60	66.65	74.60	83.97	
18/36	2.652	2.972	3.092	3.405	3.774		67.36	75.49	78.54	86.49	95.86	
22/44	3.276	3.596	3.716	4.029	4.398		83.21	91.34	94.39	102.34	111.71	
24/48	3.588	3.908	4.028	4.341	4.710		91.14	99.26	102.31	110.26	119.63	
25/50	3.744	4.064	4.184	4.497	4.866		95.10	103.23	106.27	114.22	123.60	
28/56	4.212	4.532	4.652	4.965	5.334		0.438	106.98	115.11	118.16	126.11	
36/72	5.460	5.780	5.900	6.213	6.582	138.68		146.81	149.86	157.81	167.18	
43/86	6.552	6.872	6.992	7.305	7.674	0.500	166.42	174.55	177.60	185.55	194.92	12.70
44/88	6.708	7.028	7.148	7.461	7.830		170.38	178.51	181.56	189.51	198.88	

* Consult factory for availability.

Female Card Edge

Looking for pricing, stock, or lifecycle information?

Click below to explore more details on WIN SOURCE:

- ⊖ [View EBM22DRXN on WIN SOURCE](#)
- ⊖ [Sullins Connector Solutions Information](#)

Optimize Your Supply Chain with WIN SOURCE Solutions

- ✓ Global Sourcing Solution
- ✓ Obsolete Management
- ✓ Cost Control Management
- ✓ Shortage Management
- ✓ Alternative Solution
- ✓ Excess Inventory Management