



**THE DATASHEET OF
DNT12S0A0R03NFA**



DELPHI SERIES



FEATURES

- High Efficiency: 92.5% @ 12Vin, 5V/3A out
- Small size and low profile:
 - 0.80" x 0.45" x 0.27" (SMD)
 - 0.90" x 0.40" x 0.25" (SIP)
- Standard footprint and pinout
- Resistor-based trim
- Output voltage programmable from 0.75Vdc to 5.0Vdc via external resistors
- Pre-bias startup
- No minimum load required
- Fixed frequency operation
- Input UVLO, OCP
- Remote ON/OFF
- ISO 9001, TL 9000, ISO 14001, QS9000, OHSAS18001 certified manufacturing facility
- UL/cUL 60950 (US & Canada) Recognized

Delphi series DNT12 Non-Isolated Point of Load DC/DC Power Modules: 8.3~14Vin, 0.75~5.0Vo, 3A

The Delphi series DNT12, 8.3V~14V input, 3A single output, non-isolated point of load DC/DC converters are the latest offering from a world leader in power systems technology and manufacturing — Delta Electronics, Inc. The DNT12, 3A series provides a programmable output voltage from 0.75V to 5V using external resistors. This product family is available in a surface mount or SIP package and provides up to 3A of current in an industry standard footprint and pinout. With creative design technology and optimization of component placement, these converters possess outstanding electrical and thermal performance and extremely high reliability under highly stressful operating conditions. The DNT12, 3A SIP modules have excellent thermal performance and can provide full output current with little air flow.

OPTIONS

- Negative on/off logic
- SMD package

APPLICATIONS

- Telecom/DataCom
- Distributed power architectures
- Servers and workstations
- LAN/WAN applications
- Data processing applications

DATASHEET
DS_DNT12SIP03_07042017

TECHNICAL SPECIFICATIONS

(T_A = 25°C, airflow rate = 300 LFM, V_{in} = 8.3Vdc and 14Vdc, nominal V_{out} unless otherwise noted.)

PARAMETER	NOTES and CONDITIONS	DNT12S0A0R03NFA			
		Min.	Typ.	Max.	Units
ABSOLUTE MAXIMUM RATINGS					
Input Voltage		0		15	Vdc
Operating Temperature		-40		85	°C
Storage Temperature		-55		125	°C
INPUT CHARACTERISTICS					
Operating Input Voltage		8.3	12	14	V
Input Under-Voltage Lockout					
Turn-On Voltage Threshold			7.95		V
Turn-Off Voltage Threshold			7.80		V
Maximum Input Current	V _{in} =V _{in,min} to V _{in,max} , I _o =I _{o,max}			2.2	A
No-Load Input Current	V _o =5V		50	70	mA
Off Converter Input Current			1	5	mA
Inrush Transient	V _{in} = V _{in,min} to V _{in,max} , I _o =I _{o,min} to I _{o,max}			0.4	A ² S
Recommended Input Fuse		5			A
OUTPUT CHARACTERISTICS					
Output Voltage Set Point	V _{in} =12V, I _o =I _{o,max}	-1.5	V _{o,set}	+1.5	% V _{o,set}
Output Voltage Adjustable Range		0.7525		5.0	V
Output Voltage Regulation					
Over Line	V _{in} =V _{in,min} to V _{in,max}		0.4		% V _{o,set}
Over Load	I _o =I _{o,min} to I _{o,max}		0.4		%
Over Temperature			0.4		% V _{o,set}
Total Output Voltage Range	Over sample load, line and temperature	-3.0		+3.0	% V _{o,set}
Output Voltage Ripple and Noise	5Hz to 20MHz bandwidth				
Peak-to-Peak	V _{in} =min to max, I _o =min to max 1μF ceramic, 10μF Tan		40	70	mV
RMS	V _{in} =min to max, I _o =min to max 1μF ceramic, 10μF Tan		20	25	mV
Output Current Range		0		3	A
Output Voltage Over-shoot at Start-up				5	% V _{o,set}
Output DC Current-Limit Inception			200		% I _o
Output Short-Circuit Current (Hiccup mode)	I _{o,s/c}		1.5		Adc (rms)
DYNAMIC CHARACTERISTICS					
Dynamic Load Response	47μF Tan & 1μF ceramic load cap, 2.5A/μs				
Positive Step Change in Output Current	50% I _o , max to 100% I _o , max		200		mVpk
Negative Step Change in Output Current	100% I _o , max to 50% I _o , max		200		mVpk
Setting Time to 10% of Peak Deviation			25		μs
Turn-On Transient	I _o =I _{o,max}				
Start-Up Time, From On/Off Control	V _{on/off} , V _o =10% of V _{o,set}		8	15	ms
Start-Up Time, From Input	V _{in} =V _{in,min} , V _o =10% of V _{o,set}		8	15	ms
Maximum Output Startup Capacitive Load	Full load; ESR ≥ 1mΩ			1000	μF
	Full load; ESR ≥ 10mΩ			3000	μF
EFFICIENCY					
V _o =0.75V	V _{in} =12V, I _o =I _{o,max}		72.5		%
V _o =1.2V	V _{in} =12V, I _o =I _{o,max}		80.0		%
V _o =1.5V	V _{in} =12V, I _o =I _{o,max}		83.0		%
V _o =1.8V	V _{in} =12V, I _o =I _{o,max}		85.0		%
V _o =2.5V	V _{in} =12V, I _o =I _{o,max}		88.0		%
V _o =3.3V	V _{in} =12V, I _o =I _{o,max}		90.0		%
V _o =5.0V	V _{in} =12V, I _o =I _{o,max}		92.5		%
FEATURE CHARACTERISTICS					
Switching Frequency			300		kHz
ON/OFF Control, (Negative logic)					
Logic Low Voltage	Module On, V _{on/off}	-0.2		0.3	V
Logic High Voltage	Module Off, V _{on/off}	2.5		V _{in,max}	V
Logic Low Current	Module On, I _{on/off}			10	μA
Logic High Current	Module Off, I _{on/off}		0.2	1	mA
GENERAL SPECIFICATIONS					
MTBF	I _o =I _{o,max} , T _a =25°C		22.8		M hours
Weight			2.1		grams



ELECTRICAL CHARACTERISTICS CURVES

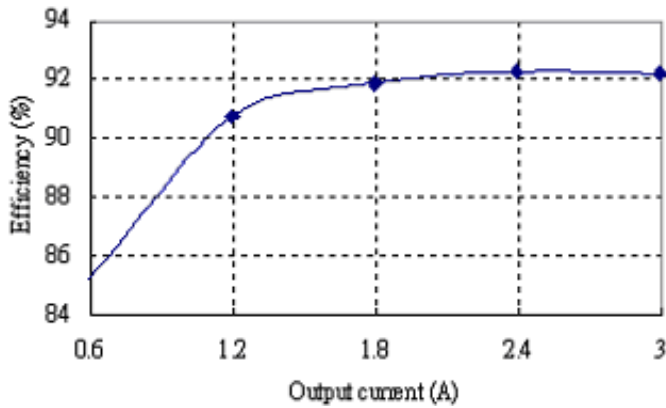

Figure 1: Converter efficiency vs. output current
(12V in, 5V output voltage)

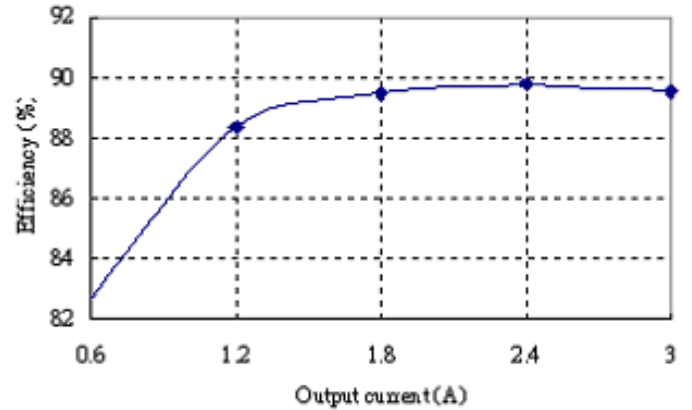

Figure 2: Converter efficiency vs. output current
(12V in, 3.3V output voltage)

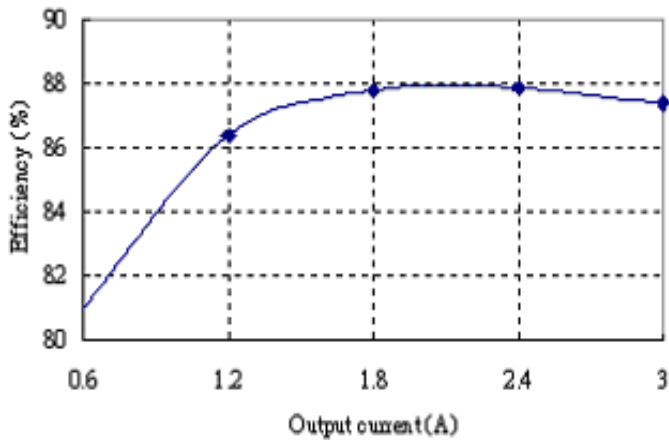

Figure 3: Converter efficiency vs. output current
(12V in, 2.5V output voltage)

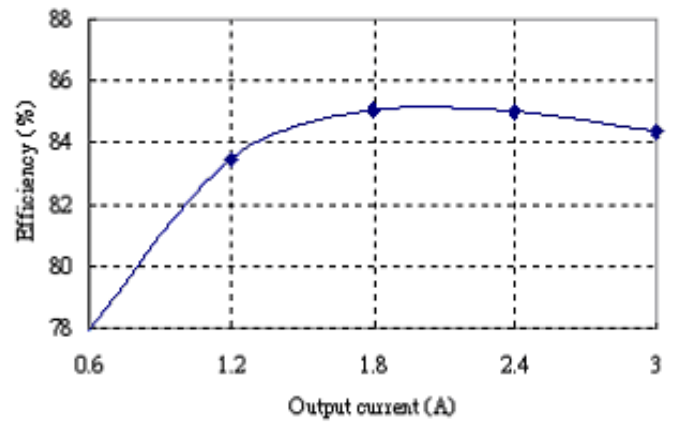

Figure 4: Converter efficiency vs. output current
(12V in, 1.8V output voltage)

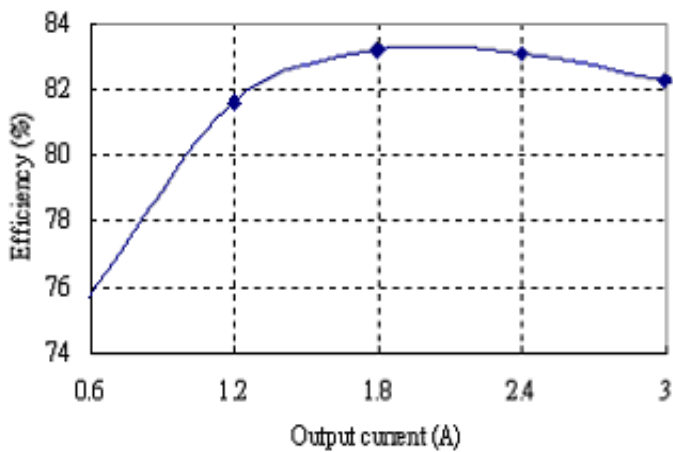

Figure 5: Converter efficiency vs. output current
(12V in, 1.5V output voltage)

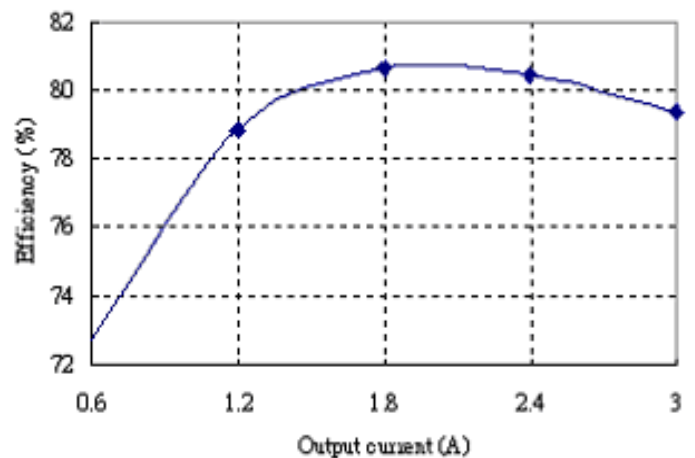

Figure 6: Converter efficiency vs. output current
(12V in, 1.2V output voltage)



ELECTRICAL CHARACTERISTICS CURVES

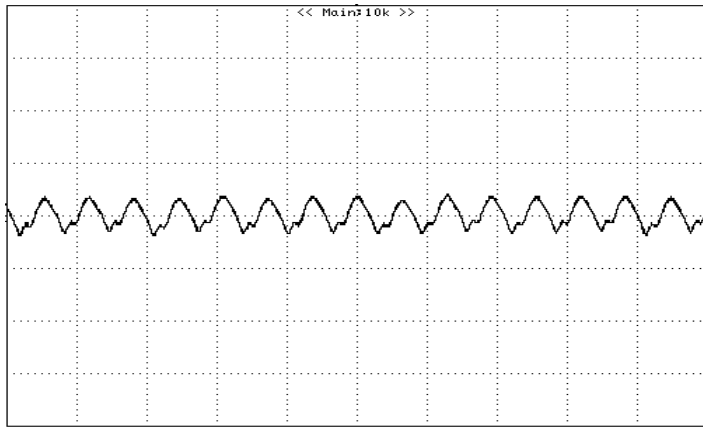

Figure 7: Output ripple & noise at 12Vin, 1.2V/3A out
20mV/div, pk-pk : 12.50mV, rms : 2.79mV(20mV/div,5uS/div)

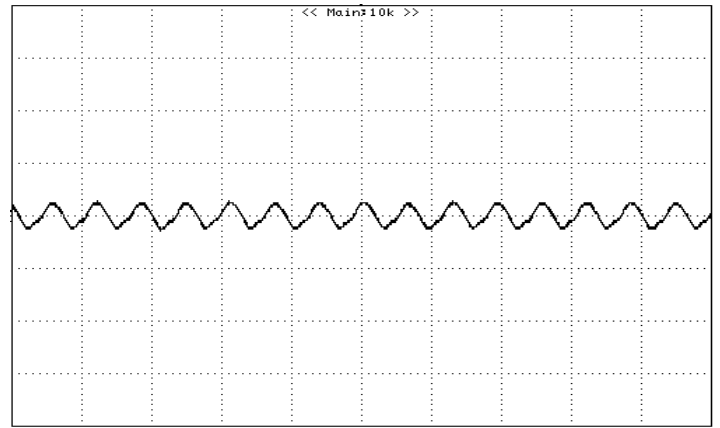

Figure 8: Output ripple & noise at 12Vin, 2.5V/3A out
50mV/div, pk-pk :27.50mV, rms :7.67mV(50mV/div,5uS/div)

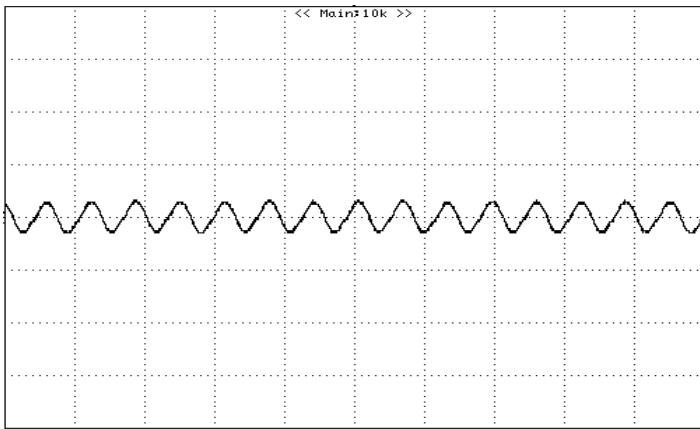

Figure 9: Output ripple & noise at 12Vin, 3.3V/3A out
50mV/div, pk-pk :300.00mV, rms :11.9mV(50mV/div,5uS/div)

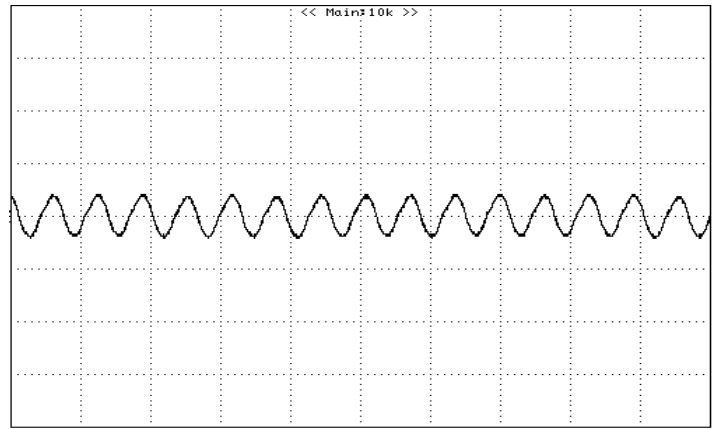

Figure 10: Output ripple & noise at 12Vin, 5.0V/3A out
pk-pk :44.16mV, rms :15.36mV (50mV/div,5uS/div)

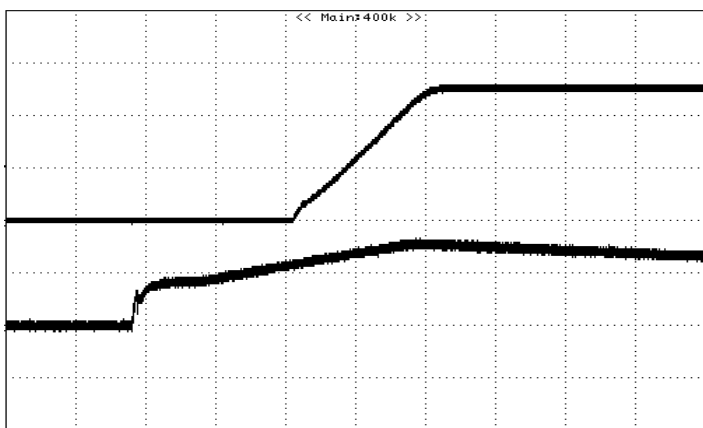

Figure 11: Turn on delay time at 12vin, 5.0V/3A out (2mS/div)
Top trace :Vout , 2V/ div ; Bottom trace :Vin ,20V/div

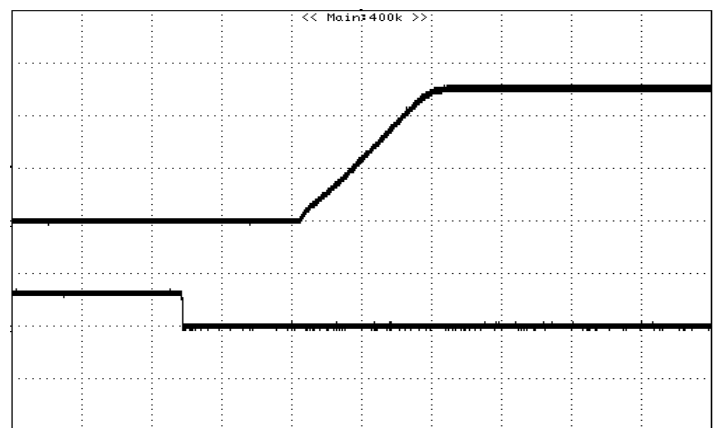

Figure 12: Turn on delay time at Remote On/Off, 5.0V/3A out (2mS/div). Top trace: Vout ,2V/div ;Bottom trace :ON/off , 5V/div.



ELECTRICAL CHARACTERISTICS CURVES

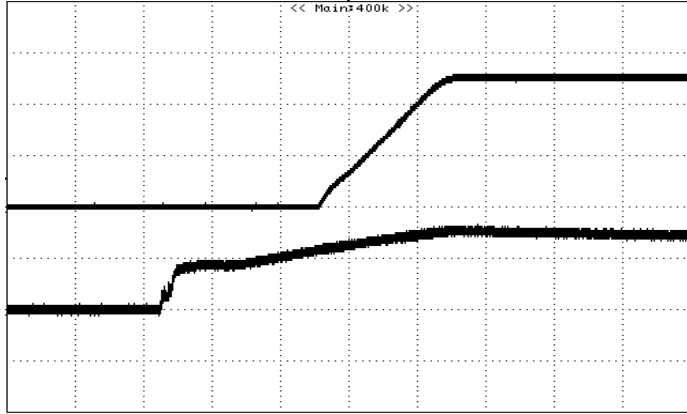

Figure 13: Turn on Using Input On/Off with external capacitors ($C_o=3000 \mu F$), 5.0V/3A out (resistive load)(2mS/div)
Top trace: Vout, 2V/div; Bottom trace: Vin ,10V/div

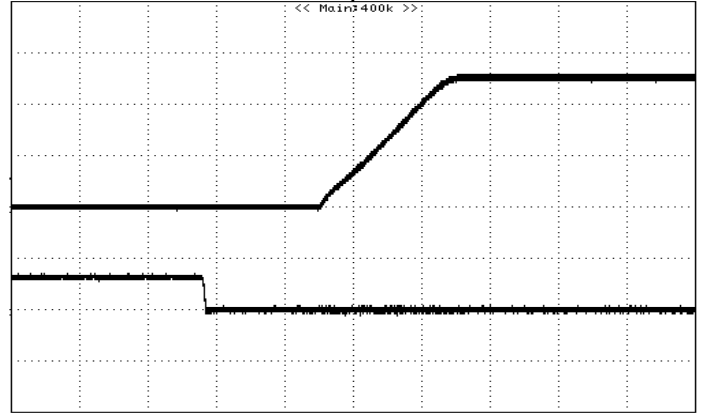

Figure 14: Turn on Using Remote On/Off with external capacitors ($C_o= 3000 \mu F$), 5.0V/3A out(resistive load)(2mS/div)
Top trace: Vout,2V/div; Bottom trace: ON/OFF,5V/div

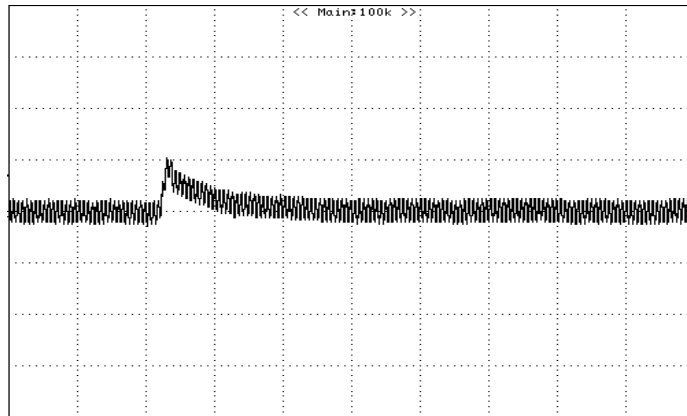

Figure 15: Typical transient response to step load change at 2.5A/μS from 100% to 50% of I_o , max at 12Vin, 5.0V out ($C_{out} = 1\mu F$ ceramic+ 47μF Ceramic)(100mV/div,50uS/div)

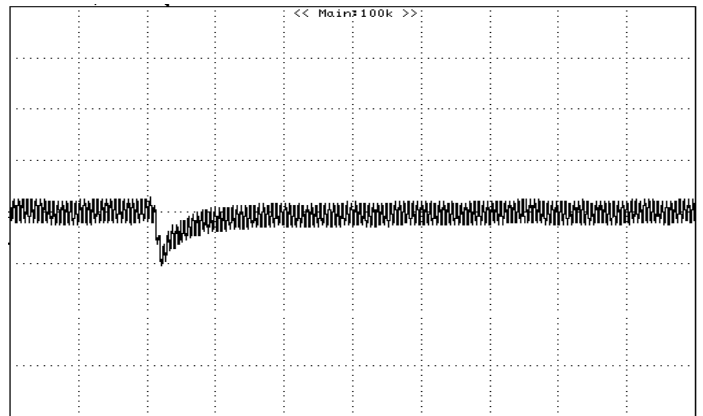

Figure 16: Typical transient response to step load change at 2.5A/μS from 50% to 100% of I_o , max at 12Vin, 5.0V out ($C_{out} = 1\mu F$ ceramic+ 47μF Ceramic)(100mV/div,50uS/div)

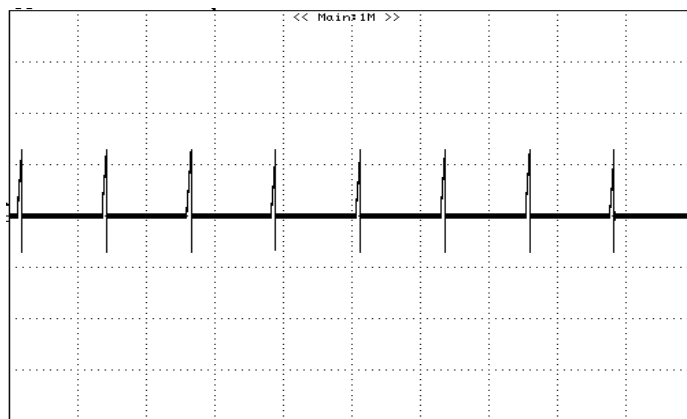

Figure 17: Output short circuit current 12Vin, 0.75Vout (0.5V/div,50mS/div)

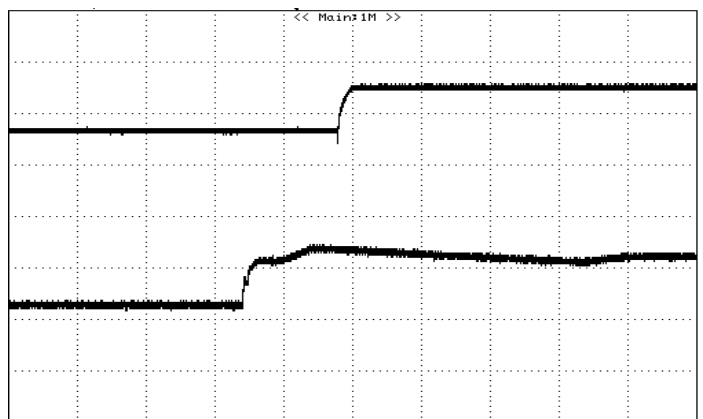
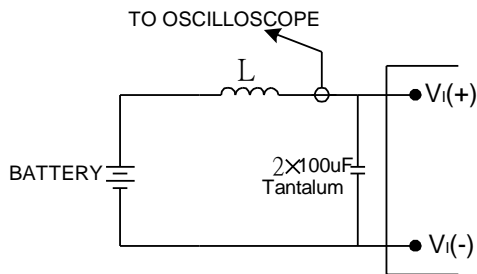

Figure 18: Turn on with Prebias 12Vin, 5V/0A out, $V_{bias} = 3.3V_{dc}$. (5mS/div)
Top trace: Vout,2V/div; Bottom trace: Vin, 10V/div

TEST CONFIGURATIONS



Note: Input reflected-ripple current is measured with a simulated source inductance. Current is measured at the input of the module.

Figure 19: Input reflected-ripple test setup

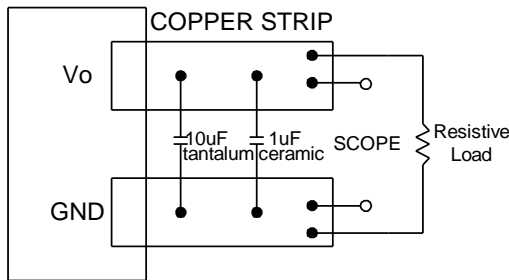

Note: Use a 10 μ F tantalum and 1 μ F capacitor. Scope measurement should be made using a BNC connector.

Figure 20: Peak-peak output noise and startup transient measurement test setup

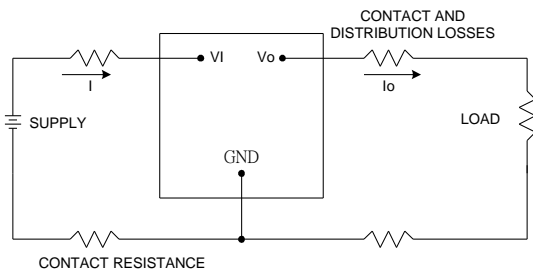

Figure 21: Output voltage and efficiency measurement test setup

Note: All measurements are taken at the module terminals. When the module is not soldered (via socket), place Kelvin connections at module terminals to avoid measurement errors due to contact resistance.

$$\eta = \left(\frac{V_o \times I_o}{V_i \times I_i} \right) \times 100 \quad \%$$

DESIGN CONSIDERATIONS

Input Source Impedance

The power module should be connected to a low ac-impedance input source. Highly inductive source impedances can affect the stability of the module. An input capacitance must be placed close to the modules input pins to filter ripple current and ensure module stability in the presence of inductive traces that supply the input voltage to the module.

Safety Considerations

For safety-agency approval the power module must be installed in compliance with the spacing and separation requirements of the end-use safety agency standards.

For the converter output to be considered meeting the requirements of safety extra-low voltage (SELV), the input must meet SELV requirements. The power module has extra-low voltage (ELV) outputs when all inputs are ELV.

The input to these units is to be provided with a adequate time-delay fuse in the ungrounded lead.

DESIGN CONSIDERATIONS (CON.)

Remote On/Off

The DNT series power modules have an On/Off pin for remote On/Off operation. Both positive and negative On/Off logic options are available in the DNT series power modules.

For positive logic module, connect an open collector (NPN) transistor or open drain (N channel) MOSFET between the On/Off pin and the GND pin (see figure 22). Positive logic On/Off signal turns the module ON during the logic high and turns the module OFF during the logic low. When the positive On/Off function is not used, leave the pin floating or tie to V_{in} (module will be On).

For negative logic module, the On/Off pin is pulled high with an external pull-up resistor (see figure 23) Negative logic On/Off signal turns the module OFF during logic high and turns the module ON during logic low. If the negative On/Off function is not used, leave the pin floating or tie to GND. (module will be On)

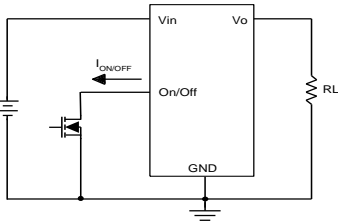

Figure 22: Positive remote On/Off implementation

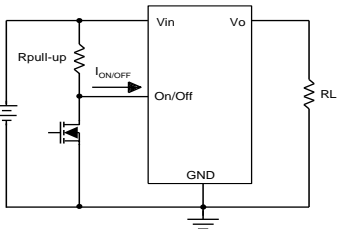

Figure 23: Negative remote On/Off implementation

Over-Current Protection

To provide protection in an output over load fault condition, the unit is equipped with internal over-current protection. When the over-current protection is triggered, the unit enters hiccup mode. The units operate normally once the fault condition is removed.

FEATURES DESCRIPTIONS

Output Voltage Programming

The output voltage of the DNT can be programmed to any voltage between 0.75Vdc and 5.0Vdc by connecting one resistor (shown as R_{trim} in Figure 24) between the TRIM and GND pins of the module. Without this external resistor, the output voltage of the module is 0.7525 Vdc. To calculate the value of the resistor R_{trim} for a particular output voltage V_o , please use the following equation:

$$R_{trim} := \left(\frac{10500}{V_o - 0.7525} - 1000 \right) \cdot \Omega$$

R_{trim} is the external resistor in Ω
 V_o is the desired output voltage

FEATURES DESCRIPTIONS (CON.)

For example, to program the output voltage of the DNT module to 3.3Vdc, Rtrim is calculated as follows:

$$R_{trim} := \left(\frac{10500}{2.5475} - 1000 \right) \cdot \Omega$$

$$R_{trim} = 3.122 \text{ k}\Omega$$

DNT can also be programmed by applying a voltage between the TRIM and GND pins (Figure 25). The following equation can be used to determine the value of Vtrim needed for a desired output voltage Vo:

$$V_{trim} := 0.7 - [(V_o - 0.7525) \cdot 0.0667]$$

Vtrim is the external voltage in V

Vo is the desired output voltage

For example, to program the output voltage of a DNT module to 3.3 Vdc, Vtrim is calculated as follows

$$V_{trim} := 0.7 - (2.5475 - 0.0667)$$

$$V_{trim} = 0.530 \text{ V}$$

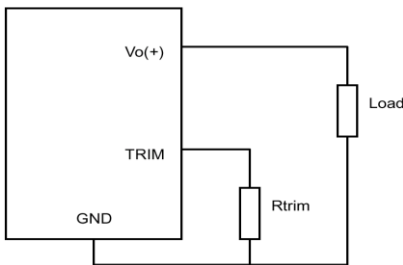

Figure 24: Circuit configuration for programming output voltage using an external resistor

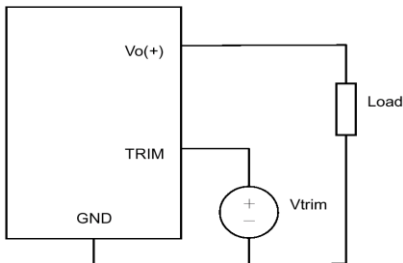

Figure 25: Circuit Configuration for programming output voltage using external voltage source

Table 1 provides Rtrim values required for some common output voltages, while Table 2 provides value of external voltage source, Vtrim, for the same common output voltages. By using a 1% tolerance trim resistor, set point tolerance of $\pm 2\%$ can be achieved as specified in the electrical specification.

DS_DNT12SIP03_07042017

Table 1

VO (V)	Rtrim (K Ω)
0.7525	Open
1.2	22.464
1.5	13.047
1.8	9.024
2.5	5.009
3.3	3.122
5.0	1.472

Table 2

VO (V)	Vtrim (V)
0.7525	Open
1.2	0.670
1.5	0.650
1.8	0.630
2.5	0.583
3.3	0.530
5.0	0.4167

The amount of power delivered by the module is the voltage at the output terminals multiplied by the output current. When using the trim feature, the output voltage of the module can be increased, which at the same output current would increase the power output of the module. Care should be taken to ensure that the maximum output power of the module must not exceed the maximum rated power ($V_{o.set} \times I_{o.max} \leq P_{max}$).

Voltage Margining

Output voltage margining can be implemented in the DNT modules by connecting a resistor, $R_{margin-up}$, from the Trim pin to the ground pin for margining-up the output voltage and by connecting a resistor, $R_{margin-down}$, from the Trim pin to the output pin for margining-down. Figure 26 shows the circuit configuration for output voltage margining. If unused, leave the trim pin unconnected. A calculation tool is available from the evaluation procedure, which computes the values of $R_{margin-up}$ and $R_{margin-down}$ for a specific output voltage and margin percentage.

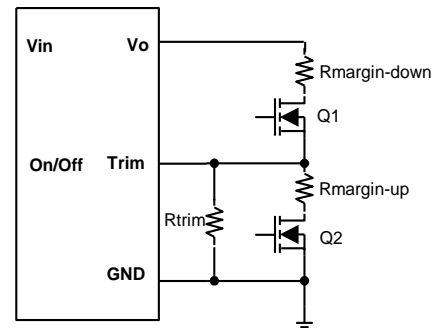

Figure 26: Circuit configuration for output voltage margining



THERMAL CONSIDERATIONS

Thermal management is an important part of the system design. To ensure proper, reliable operation, sufficient cooling of the power module is needed over the entire temperature range of the module. Convection cooling is usually the dominant mode of heat transfer.

Hence, the choice of equipment to characterize the thermal performance of the power module is a wind tunnel.

Thermal Testing Setup

Delta's DC/DC power modules are characterized in heated vertical wind tunnels that simulate the thermal environments encountered in most electronics equipment. This type of equipment commonly uses vertically mounted circuit cards in cabinet racks in which the power modules are mounted.

The following figure shows the wind tunnel characterization setup. The power module is mounted on a test PWB and is vertically positioned within the wind tunnel. The height of this fan duct is constantly kept at 25.4mm (1").

Thermal Derating

Heat can be removed by increasing airflow over the module. To enhance system reliability, the power module should always be operated below the maximum operating temperature. If the temperature exceeds the maximum module temperature, reliability of the unit may be affected.

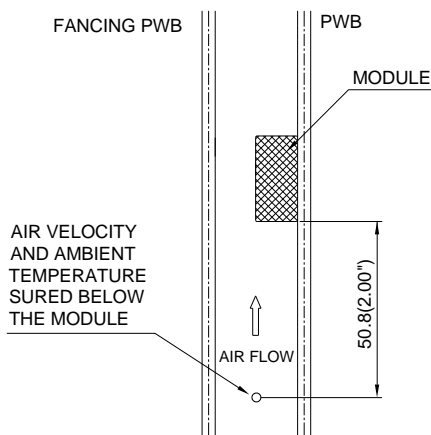

Note: Wind Tunnel Test Setup Figure Dimensions are in millimeters and (Inches)

Figure 27: Wind tunnel test setup

THERMAL CURVES

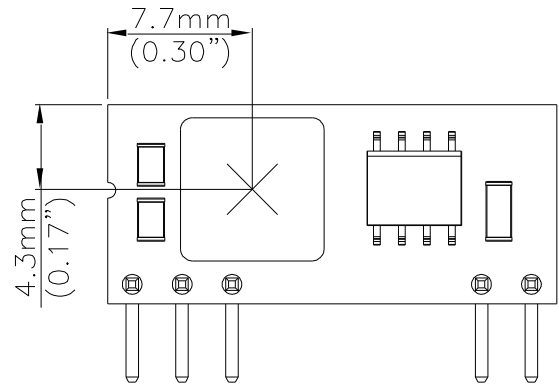

Figure 28: Temperature measurement location
The allowed maximum hot spot temperature is defined at 125°C.

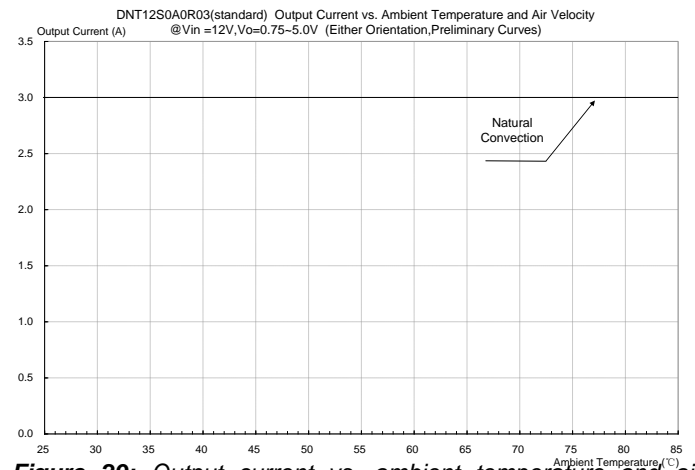
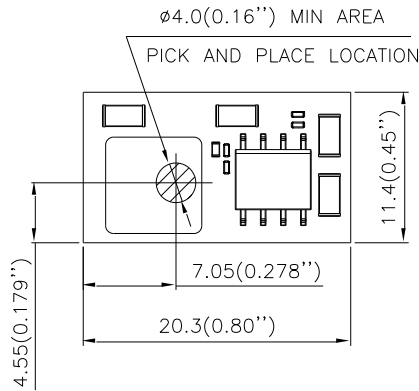

Figure 29: Output current vs. ambient temperature and air velocity @ Vin=12V, Vo=0.75-5V (Either Orientation, preliminary curves)



PICK AND PLACE LOCATION



NOTES:

ALL DIMENSIONS ARE IN MILLIMETERS AND (INCHES)
 TOLERANCES: X.Xmm \pm 0.5mm(X.XX in. \pm 0.02 in.)
 X.XXmm \pm 0.25mm(X.XXX in. \pm 0.010 in.)

SURFACE-MOUNT TAPE & REEL

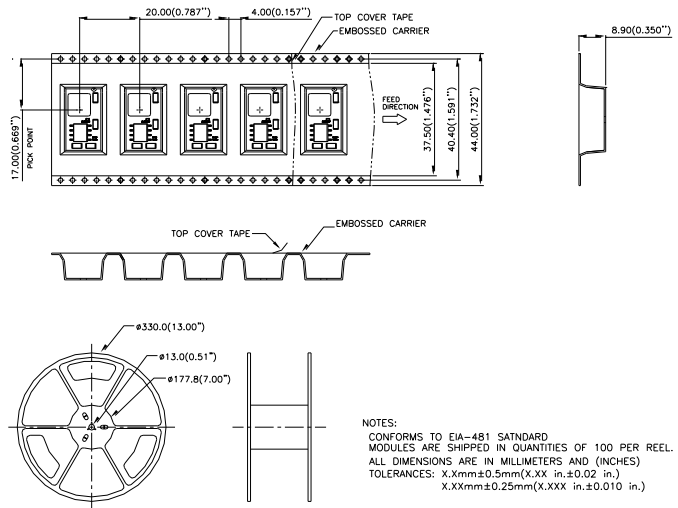

NOTES:

CONFORMS TO EIA-481 STANDARD
 MODULES ARE SHIPPED IN QUANTITIES OF 100 PER REEL.
 ALL DIMENSIONS ARE IN MILLIMETERS AND (INCHES)
 TOLERANCES: X.Xmm \pm 0.5mm(X.XX in. \pm 0.02 in.)
 X.XXmm \pm 0.25mm(X.XXX in. \pm 0.010 in.)

LEAD (Sn/Pb) PROCESS RECOMMEND TEMP. PROFILE

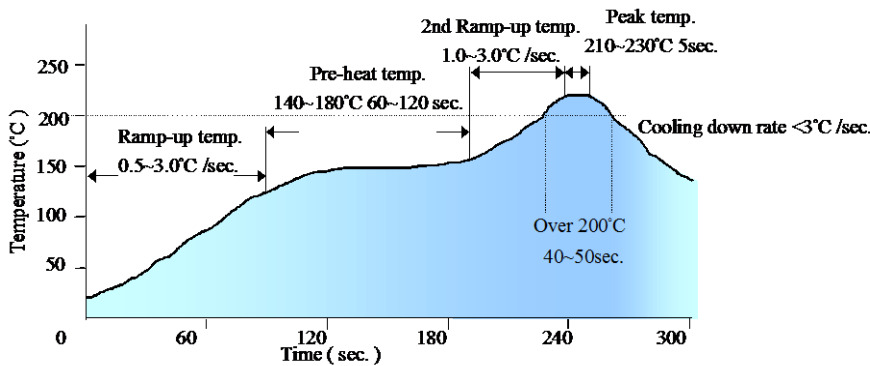

LEAD FREE (SAC) PROCESS RECOMMEND TEMP. PROFILE

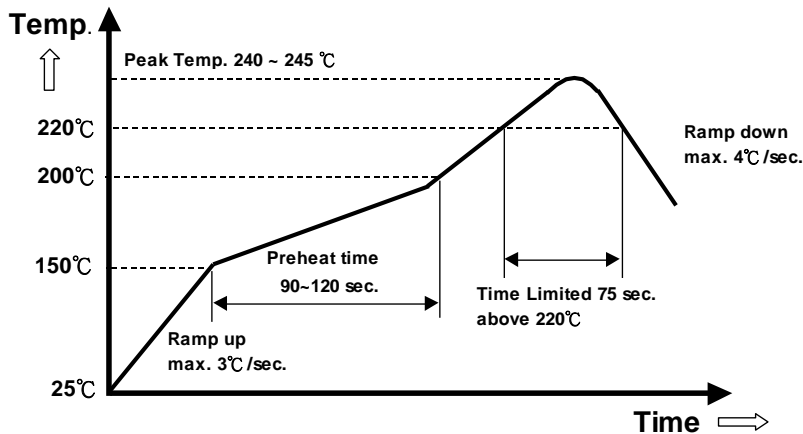

Note: All temperature refers to assembly application board, measured on the land of assembly application board.

MECHANICAL DRAWING

SMD PACKAGE (OPTIONAL)

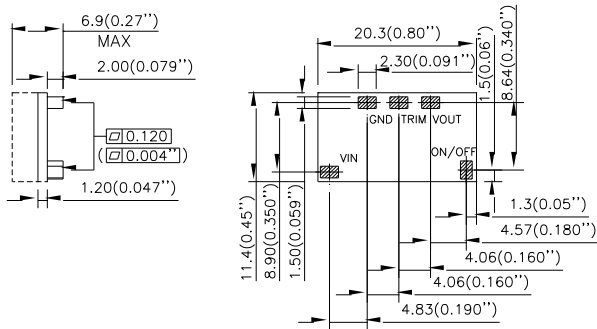

SIDE VIEW

BOTTOM VIEW

SIP PACKAGE

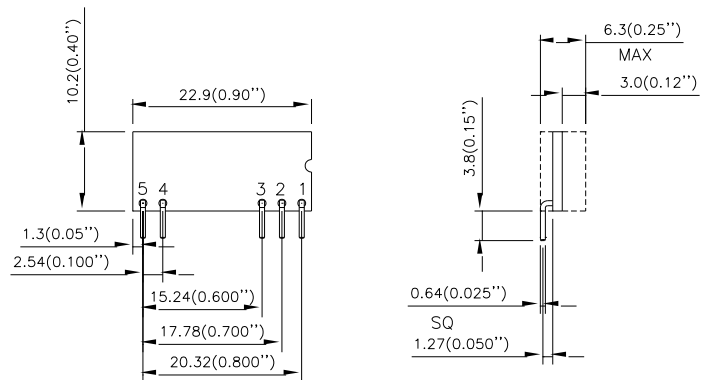

BACK VIEW

SIDE VIEW

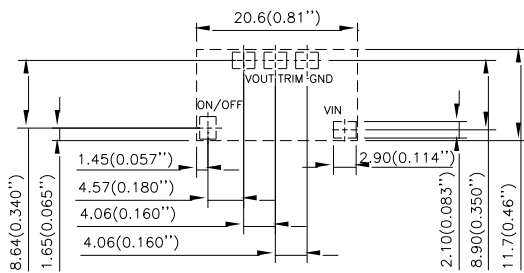

RECOMMEND PWB PAD LAYOUT

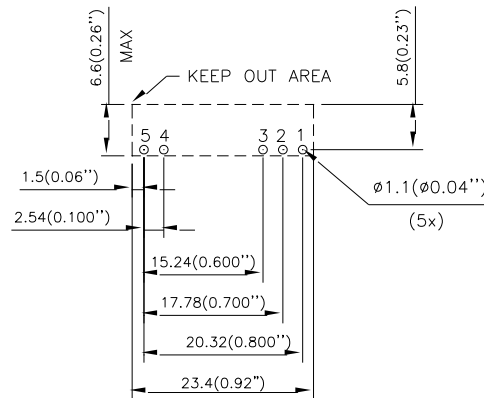

RECOMMEND PWB PAD LAYOUT

PIN#	FUNCTION
1	Vout
2	TRIM
3	GND
4	Vin
5	On/Off

NOTES:

DIMENSIONS ARE IN MILLIMETERS AND (INCHES)

TOLERANCES: X.Xmm±0.5mm(X.XX in.±0.02 in.)

X.XXmm±0.25mm(X.XXX in.±0.010 in.)

Note: All pins are copper alloy with matte tin(Pb free) plated over Nickel under-plating.

PART NUMBERING SYSTEM

DNT	12	S	0A0	R	03	N	F	A
Product Series	Input Voltage	Numbers of Outputs	Output Voltage	Package Type	Output Current	On/Off logic		Option Code
DNT - 3A or 5A	04 - 2.4V ~ 5.5V 12 - 8.3V ~ 14V	S - Single	0A0 - Programmable	R - SIP S - SMD	03 - 3A	N - negative (Default) P - positive	F - RoHS 6/6 (Lead Free)	A - Standard Functions

MODEL LIST

Model Name	Package	Input Voltage	Output Voltage	Output Current	Efficiency 12Vin, 5Vout full load
DNT12S0A0S03NFA	SMD	8.3V ~ 14Vdc	0.75V ~ 5.0Vdc	3A	92.5%
DNT12S0A0R03NFA	SIP	8.3V ~ 14Vdc	0.75V ~ 5.0Vdc	3A	92.5%
DNT12S0A0R03PFA	SIP	8.3V ~ 14Vdc	0.75V ~ 5.0Vdc	3A	92.5%
DNT12S0A0S05NFA	SMD	8.3V ~ 14Vdc	0.75V ~ 5.0Vdc	5A	92%
DNT12S0A0R05NFA	SIP	8.3V ~ 14Vdc	0.75V ~ 5.0Vdc	5A	92%

CONTACT: www.deltaww.com/dcdc **EMAIL:** dcdc@deltaww.com

USA:

Telephone:
East Coast: 978-656-3993
West Coast: 510-668-5100
Fax: (978) 656 3964

Europe:

Phone: +31-20-655-0967
Fax: +31-20-655-0999

Asia & the rest of world:

Telephone: +886 3 4526107 ext 6220-6224
Fax: +886 3 4513485

WARRANTY

Delta offers a two (2) year limited warranty. Complete warranty information is listed on our web site or is available upon request from Delta.

Information furnished by Delta is believed to be accurate and reliable. However, no responsibility is assumed by Delta for its use, nor for any infringements of patents or other rights of third parties, which may result from its use. No license is granted by implication or otherwise under



Looking for pricing, stock, or lifecycle information?

Click below to explore more details on WIN SOURCE:

 [View DNT12S0A0R03NFA on WIN SOURCE](#)

 [Delta Electronics](#) Information

Optimize Your Supply Chain with WIN SOURCE Solutions

-  Global Sourcing Solution
-  Obsolete Management
-  Cost Control Management
-  Shortage Management
-  Alternative Solution
-  Excess Inventory Management