



**THE DATASHEET OF
DMC2004DWK-7**



Features

- Low On-Resistance
- Low Gate Threshold Voltage $V_{GS(th)} < 1V$
- Low Input Capacitance
- Fast Switching Speed
- Low Input/Output Leakage
- Complementary Pair MOSFET
- Ultra-Small Surface Mount Package
- **Lead Free/RoHS Compliant (Note 2)**
- **ESD Protected Gate**
- **"Green" Device (Note 3)**

Mechanical Data

- Case: SOT-363
- Case Material: Molded Plastic. UL Flammability Classification Rating 94V-0
- Moisture Sensitivity: Level 1 per J-STD-020C
- Terminals: Solderable per MIL-STD-202, Method 208
- Lead Free Plating (Matte Tin Finish annealed over Alloy 42 leadframe).
- Terminal Connections: See Diagram
- Marking Information: See Page 7
- Ordering & Date Code Information: See Page 7
- Weight: 0.006 grams (approximate)



TOP VIEW

SOT-363

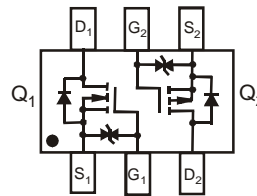

TOP VIEW

Internal Schematic

Maximum Ratings N-CHANNEL – Q₁ @T_A = 25°C unless otherwise specified

Characteristic	Symbol	Value	Unit
Drain Source Voltage	V _{DSS}	20	V
Gate-Source Voltage	V _{GSS}	±8	V
Drain Current (Note 1)	I _D	T _A = 25°C	540
		T _A = 85°C	390

Maximum Ratings P-CHANNEL – Q₂ @T_A = 25°C unless otherwise specified

Characteristic	Symbol	Value	Unit
Drain Source Voltage	V _{DSS}	-20	V
Gate-Source Voltage	V _{GSS}	±8	V
Drain Current (Note 1)	I _D	T _A = 25°C	-430
		T _A = 85°C	-310

Thermal Characteristics – Total Device @T_A = 25°C unless otherwise specified

Characteristic	Symbol	Value	Unit
Power Dissipation (Note 1)	P _d	250	mW
Thermal Resistance, Junction to Ambient	R _{θJA}	500	°C/W
Operating and Storage Temperature Range	T _j , T _{STG}	-65 to +150	°C

- Notes:
1. Device mounted on FR-4 PCB.
 2. No purposefully added lead.
 3. Diodes Inc.'s "Green" policy can be found on our website at http://www.diodes.com/products/lead_free/index.php.

Electrical Characteristics N-CHANNEL – Q₁ @T_A = 25°C unless otherwise specified

Characteristic	Symbol	Min	Typ	Max	Unit	Test Condition
OFF CHARACTERISTICS (Note 4)						
Drain-Source Breakdown Voltage	BV _{DSS}	20	—	—	V	V _{GS} = 0V, I _D = 10μA
Zero Gate Voltage Drain Current	I _{DSS}	—	—	1	μA	V _{DS} = 16V, V _{GS} = 0V
Gate-Source Leakage	I _{GSS}	—	—	± 1	μA	V _{GS} = ±4.5V, V _{DS} = 0V
ON CHARACTERISTICS (Note 4)						
Gate Threshold Voltage	V _{GS(th)}	0.5	—	1.0	V	V _{DS} = V _{GS} , I _D = 250μA
Static Drain-Source On-Resistance	R _{DS(ON)}	—	0.4	0.55	Ω	V _{GS} = 4.5V, I _D = 540mA
		—	0.5	0.70		V _{GS} = 2.5V, I _D = 500mA
		—	0.7	0.90		V _{GS} = 1.8V, I _D = 350mA
Forward Transfer Admittance	Y _{fs}	200	—	—	mS	V _{DS} = 10V, I _D = 0.2A
Diode Forward Voltage (Note 4)	V _{SD}	0.5	—	1.2	V	V _{GS} = 0V, I _S = 115mA
DYNAMIC CHARACTERISTICS						
Input Capacitance	C _{iss}	—	—	150	pF	V _{DS} = 16V, V _{GS} = 0V f = 1.0MHz
Output Capacitance	C _{oss}	—	—	25	pF	
Reverse Transfer Capacitance	C _{rss}	—	—	20	pF	

Electrical Characteristics P-CHANNEL – Q₂ @T_A = 25°C unless otherwise specified

Characteristic	Symbol	Min	Typ	Max	Unit	Test Condition
OFF CHARACTERISTICS (Note 4)						
Drain-Source Breakdown Voltage	BV _{DSS}	-20	—	—	V	V _{GS} = 0V, I _D = -250μA
Zero Gate Voltage Drain Current	I _{DSS}	—	—	-1.0	μA	V _{DS} = -20V, V _{GS} = 0V
Gate-Source Leakage	I _{GSS}	—	—	± 1.0	μA	V _{GS} = ±4.5V, V _{DS} = 0V
ON CHARACTERISTICS (Note 4)						
Gate Threshold Voltage	V _{GS(th)}	-0.5	—	-1.0	V	V _{DS} = V _{GS} , I _D = -250μA
Static Drain-Source On-Resistance	R _{DS(ON)}	—	0.7	0.9	Ω	V _{GS} = -4.5V, I _D = -430mA
		—	1.1	1.4		V _{GS} = -2.5V, I _D = -300mA
		—	1.7	2.0		V _{GS} = -1.8V, I _D = -150mA
Forward Transfer Admittance	Y _{fs}	200	—	—	mS	V _{DS} = 10V, I _D = 0.2A
Diode Forward Voltage (Note 4)	V _{SD}	-0.5	—	-1.2	V	V _{GS} = 0V, I _S = -115mA
DYNAMIC CHARACTERISTICS						
Input Capacitance	C _{iss}	—	—	175	pF	V _{DS} = -16V, V _{GS} = 0V f = 1.0MHz
Output Capacitance	C _{oss}	—	—	30	pF	
Reverse Transfer Capacitance	C _{rss}	—	—	20	pF	

Notes: 4. Short duration pulse test used to minimize self-heating effect.

Q₁, N-CHANNEL

NEW PRODUCT

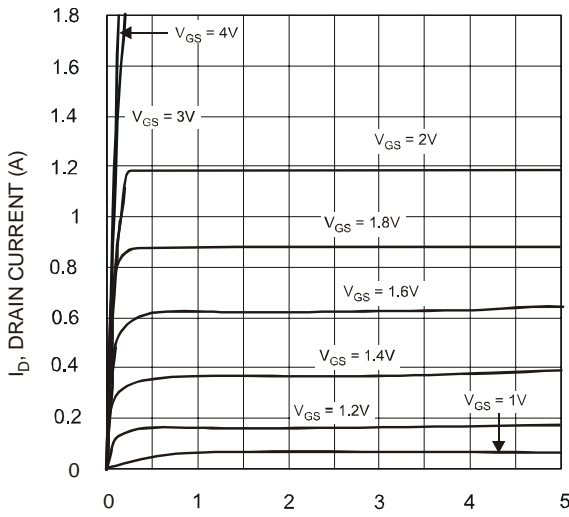

V_{DS} , DRAIN SOURCE VOLTAGE (V)
Fig. 1 Typical Output Characteristics

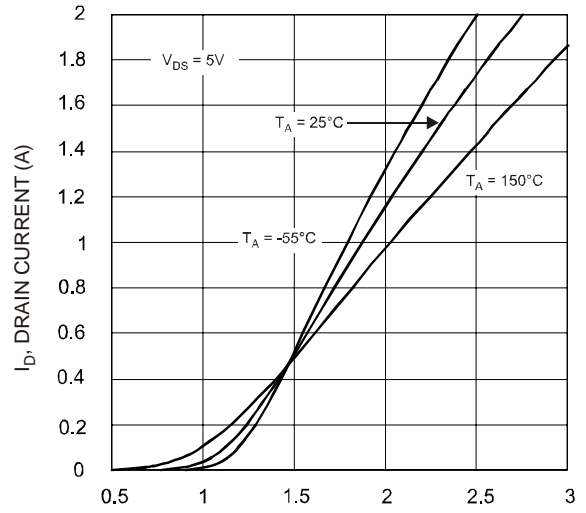

V_{GS} , GATE SOURCE VOLTAGE (V)
Fig. 2 Typical Transfer Characteristics

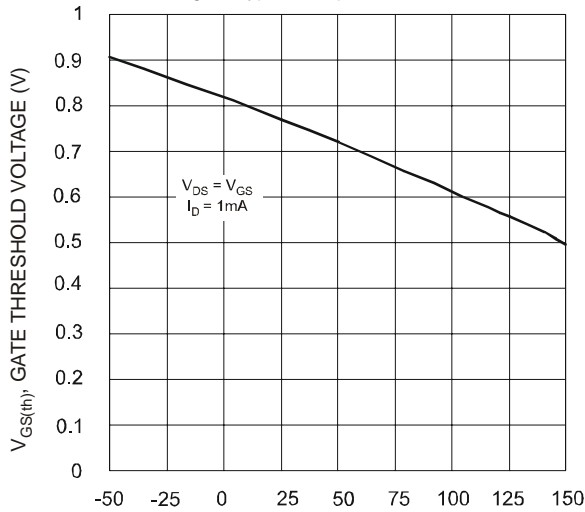

T_A , AMBIENT TEMPERATURE (°C)
Fig. 3 Gate Threshold Voltage vs. Ambient Temperature

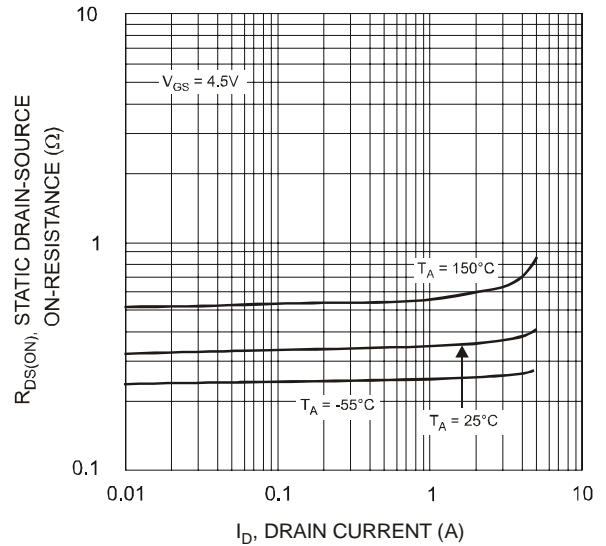

I_D , DRAIN CURRENT (A)
Fig. 4 Static Drain-Source On-Resistance vs. Drain Current

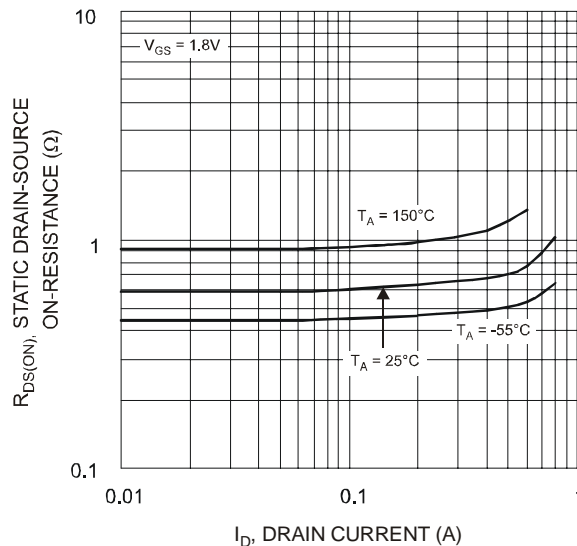

I_D , DRAIN CURRENT (A)
Fig. 5 Static Drain-Source On-Resistance vs. Drain Current

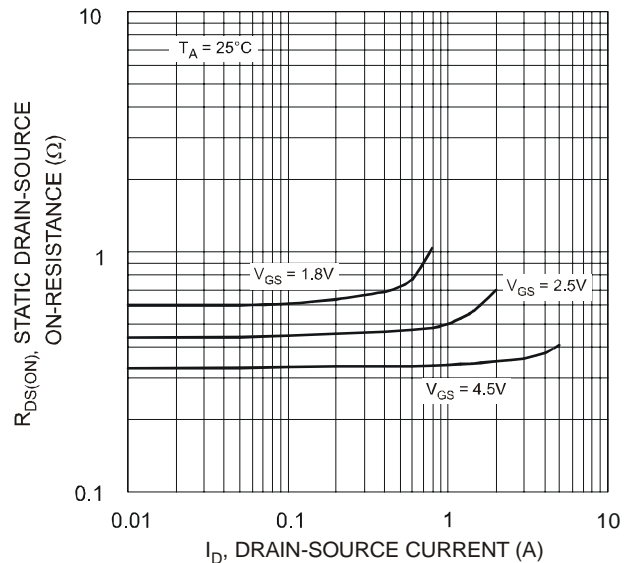

I_{DS} , DRAIN-SOURCE CURRENT (A)
Fig. 6 Static Drain-Source On-Resistance vs. Drain-Source Current vs. Gate Source Voltage

Q₁, N-CHANNEL, continued

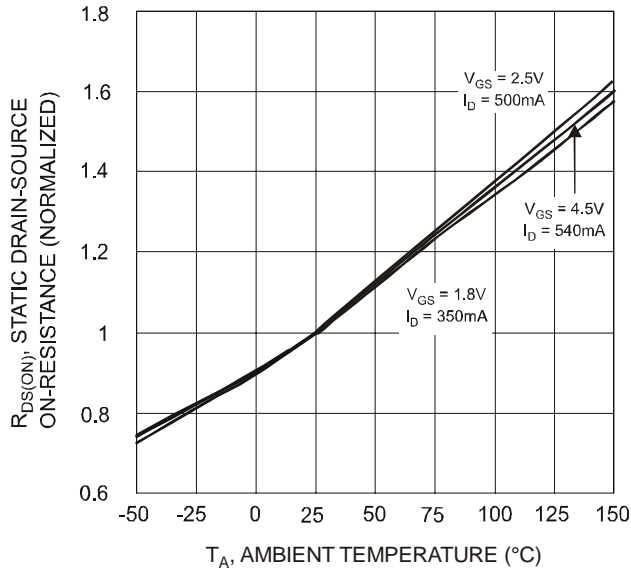

Fig. 7 Static Drain-Source On-State Resistance vs. Ambient Temperature

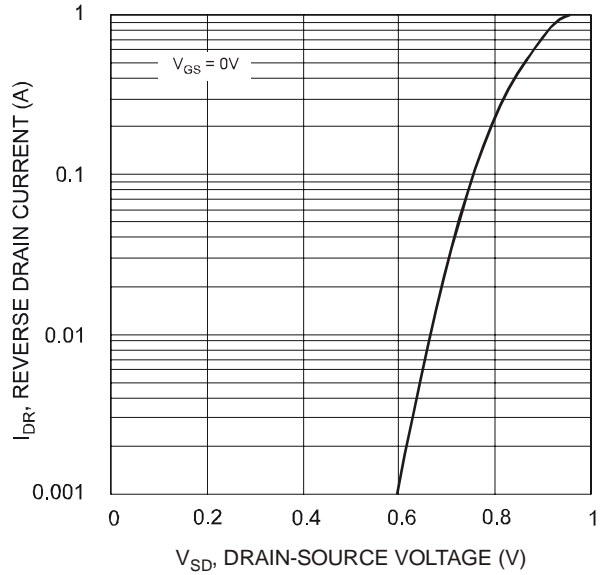

Fig. 8 Reverse Drain Current vs. Source-Drain Voltage

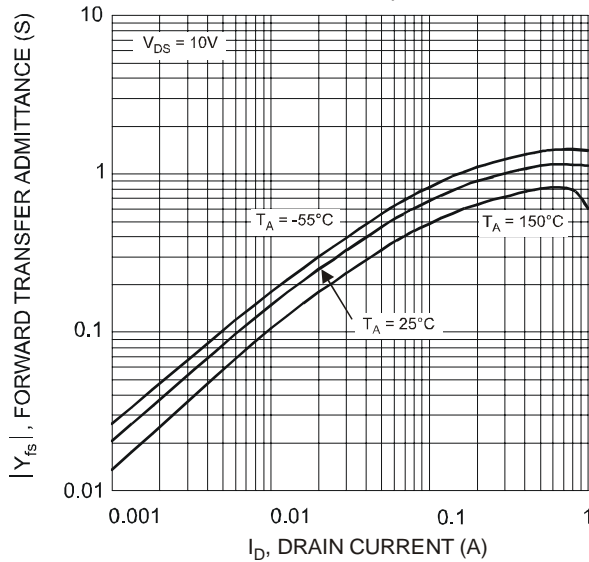

Fig. 9 Forward Transfer Admittance vs. Drain Current

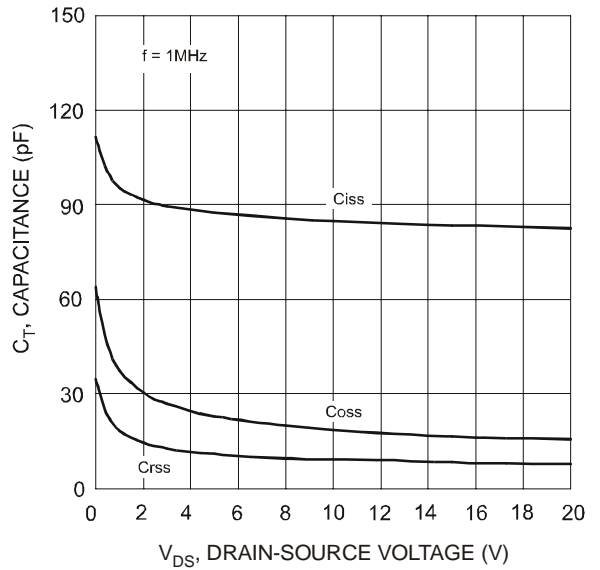

Fig. 10 Typical Capacitance

Q₂, P-CHANNEL

NEW PRODUCT

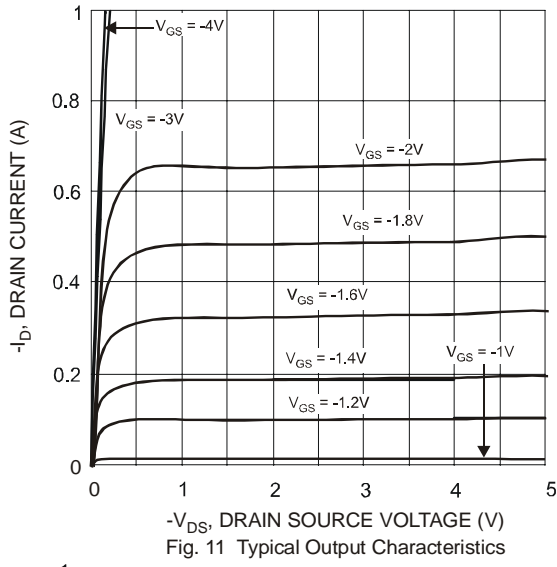

Fig. 11 Typical Output Characteristics

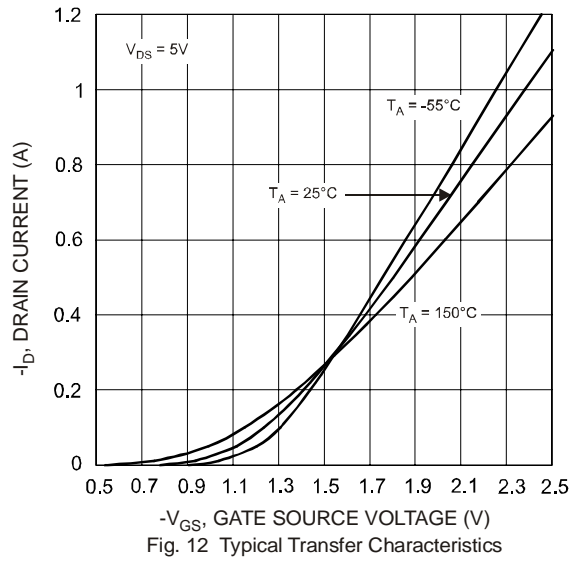

Fig. 12 Typical Transfer Characteristics

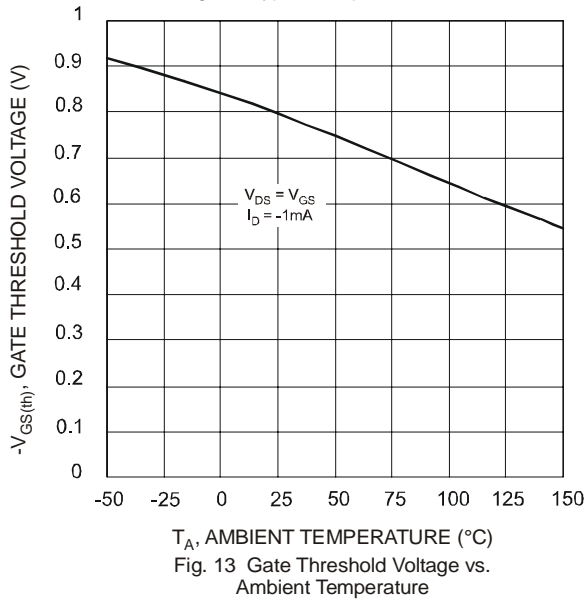

Fig. 13 Gate Threshold Voltage vs. Ambient Temperature

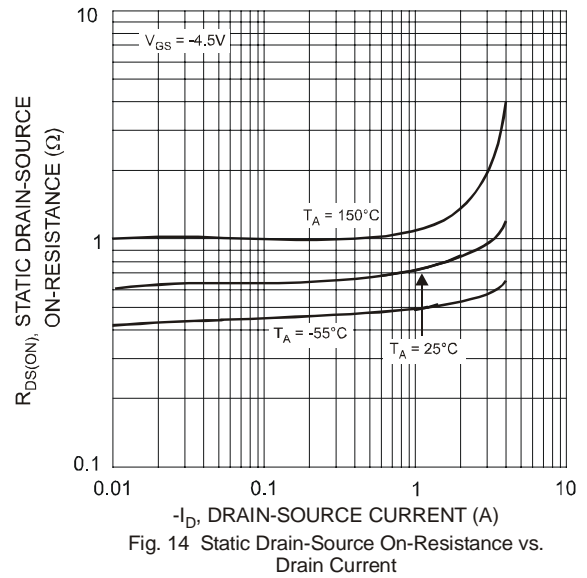

Fig. 14 Static Drain-Source On-Resistance vs. Drain Current

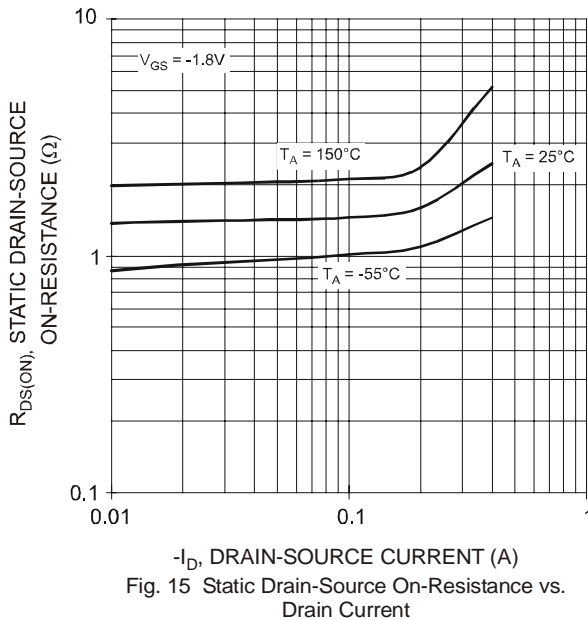

Fig. 15 Static Drain-Source On-Resistance vs. Drain Current

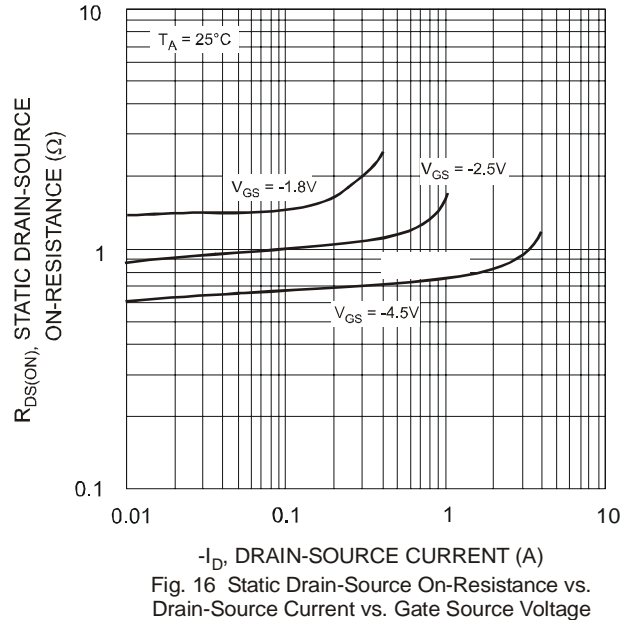

Fig. 16 Static Drain-Source On-Resistance vs. Drain-Source Current vs. Gate Source Voltage

Q₂, P-CHANNEL, Continued

NEW PRODUCT

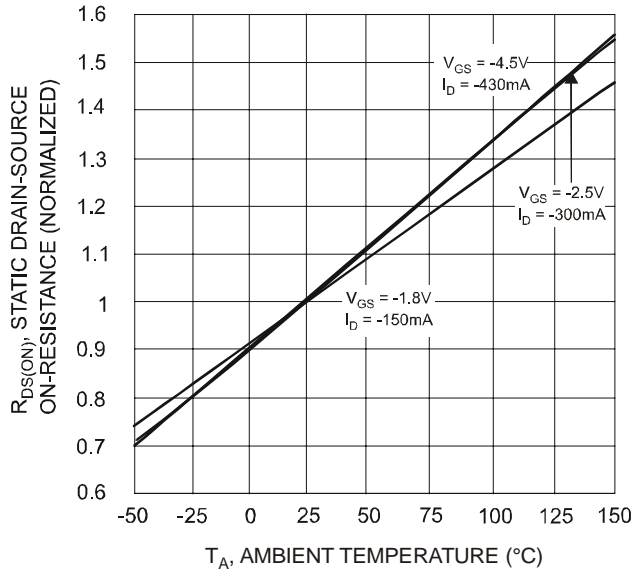

Fig. 17 Static Drain-Source On-State Resistance vs. Ambient Temperature

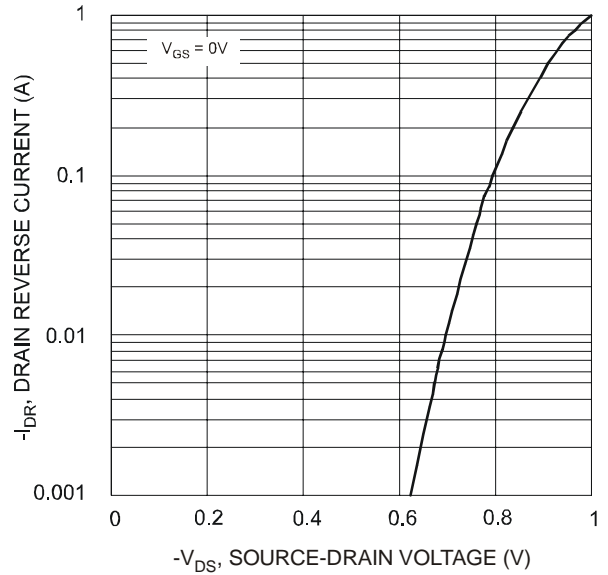

Fig. 18 Reverse Drain Current vs. Source-Drain Voltage

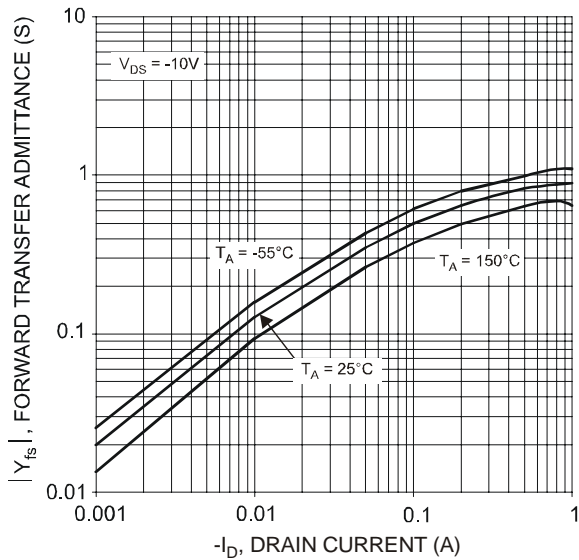

Fig. 19 Forward Transfer Admittance vs. Drain Current

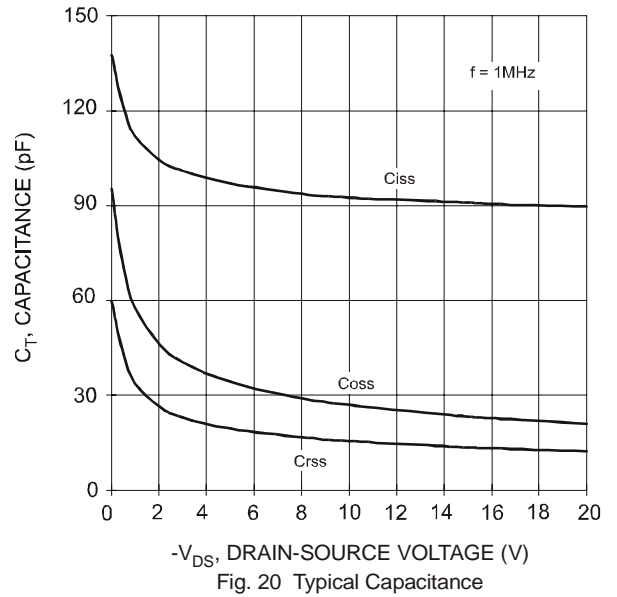

Fig. 20 Typical Capacitance

Ordering Information (Note 5)

Part Number	Case	Packaging
DMC2004DWK-7	SOT-363	3000/Tape & Reel

Notes: 5. For packaging details, go to our website at <http://www.diodes.com/datasheets/ap02007.pdf>.

Marking Information

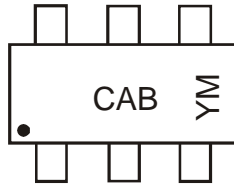

CAB = Marking Code
 YM = Date Code Marking
 Y = Year ex: U = 2007
 M = Month ex: 9 = September

Date Code Key

Year	2007	2008	2009	2010	2011	2012
Code	U	V	W	X	Y	Z

Month	Jan	Feb	Mar	Apr	May	Jun	Jul	Aug	Sep	Oct	Nov	Dec
Code	1	2	3	4	5	6	7	8	9	O	N	D

Package Outline Dimensions

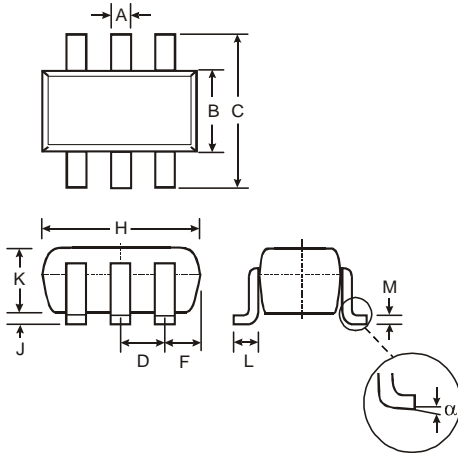

SOT-363		
Dim	Min	Max
A	0.10	0.30
B	1.15	1.35
C	2.00	2.20
D	0.65 Nominal	
F	0.30	0.40
H	1.80	2.20
J	—	0.10
K	0.90	1.00
L	0.25	0.40
M	0.10	0.25
α	0°	8°
All Dimensions in mm		

Suggested Pad Layout

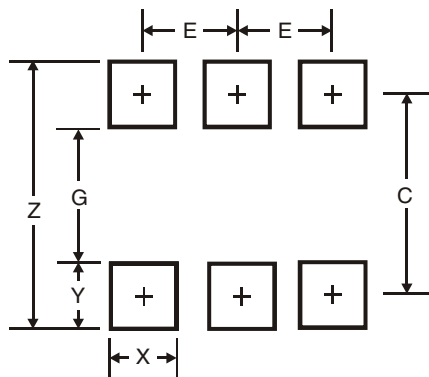

Dimensions	Value (in mm)
Z	2.5
G	1.3
X	0.42
Y	0.6
C	1.9
E	0.65

IMPORTANT NOTICE



Diodes Incorporated and its subsidiaries reserve the right to make modifications, enhancements, improvements, corrections or other changes without further notice to any product herein. Diodes Incorporated does not assume any liability arising out of the application or use of any product described herein; neither does it convey any license under its patent rights, nor the rights of others. The user of products in such applications shall assume all risks of such use and will agree to hold Diodes Incorporated and all the companies whose products are represented on our website, harmless against all damages.

LIFE SUPPORT

Diodes Incorporated products are not authorized for use as critical components in life support devices or systems without the expressed written approval of the President of Diodes Incorporated.

Looking for pricing, stock, or lifecycle information?

Click below to explore more details on WIN SOURCE:

-  [View DMC2004DWK-7 on WIN SOURCE](#)
-  [Diodes Incorporated Information](#)

Optimize Your Supply Chain with WIN SOURCE Solutions

-  Global Sourcing Solution
-  Obsolete Management
-  Cost Control Management
-  Shortage Management
-  Alternative Solution
-  Excess Inventory Management