



**THE DATASHEET OF
L50QS100.T**



L50QS SERIES HIGH-SPEED ROUND BODY FUSES

500 Vac/dc • 35-800 A • Traditional Round Body Bolted Style



Description

The L50QS Series is a next generation High-Speed Fuse for the protection of power semiconductor devices and is designed in the Traditional North American Bolted Style package.

L50QS Series High-Speed Fuses are extremely current limiting and are used to protect power converters, drives and control circuit applications. Designed with lower I²t performance characteristics, these fuses provide balanced performance to extend longevity while lowering potentially damaging heat energy to the devices being protected.

In addition L50QS Series fuses have been designed with a universal mounting option to meet customer requirements for installation into a variety of application configurations

Littelfuse POWR-SPEED™ products offer optimized circuit protection at the extremely fast speed required to protect modern day, sensitive, high-power semiconductor devices. Such products are commonly found in various industries including pulp and paper industries, cranes and heavy-lifting equipment, processing industries, wastewater treatment plants and large factories and MRO facilities.

Features

- Compliance with US and Canadian Requirements
- Traditional North American Bolted Style dimensions
- Class aR performance
- Direct bus-bar mount or stud mount design
- Halogen Free, RoHS and REACH Compliant

Applications

- Power Converters (Inverters, Rectifiers)
- Power Supplies
- UPS
- Variable Speed Drives
- Control Circuits
- Soft Starters

Specifications

Voltage Rating	AC: 500V DC: 500V
Amperage Rating	35 - 800 A
Interrupting Rating	AC: 200 kA DC: 50 kA
Time Constant	10ms
Material	Body: Melamine Caps: Copper Alloy (Silver Plated)
Approvals	UL Recognized (E71611) c-UR-us (E71611)
Environmental	RoHS Compliant, REACH
Country of Origin	Mexico
Operating Temperature	-55C to +125C
Storage Temperature	Up to 35C with Relative Humidity <65%

Part Numbering System

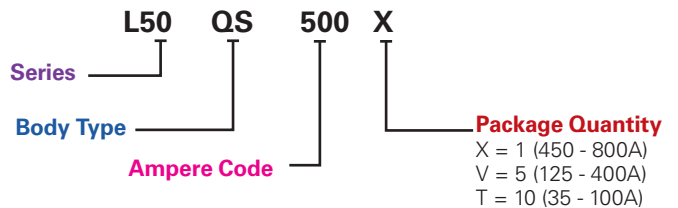

SERIES	BODY TYPE	AMPERE CODE	PACKAGE QUANTITY	CATALOG NUMBER	ORDERING NUMBER
L50	QS	500	1	L50QS500	L50QS500.X

Recommended Fuse Blocks

- LSCR001 (35-200A)
- LSCR002 (225-800A)



Web Resources

Download technical documents: littelfuse.com/L50QS

L50QS SERIES HIGH-SPEED ROUND BODY FUSES

Electrical Specifications

CATALOG NUMBER	AMPERAGE RATING	VOLTAGE RATING		INTERRUPT RATING		MELTING (PRE-ARC) I ² T (A ² s)	TOTAL CLEARING I ² T (A ² s)	TOTAL CLEARING I ² T (A ² s)	WATTS LOSS AT 80% RATED CURRENT	WATTS LOSS AT 100% RATED CURRENT
		AC	DC	AC	DC		200 kA @ 500 Vac	50 kA @ 500 Vdc	(W)	(W)
L50QS035	35	500	500	200kA	50kA	111	430	290	3	5
L50QS040	40	500	500	200kA	50kA	137	530	363	3	9
L50QS050	50	500	500	200kA	50kA	211	770	516	5	8
L50QS060	60	500	500	200kA	50kA	269	1,500	881	5	9
L50QS070	70	500	500	200kA	50kA	393	1,775	1,185	6	11
L50QS080	80	500	500	200kA	50kA	616	3,550	1,720	6	11
L50QS090	90	500	500	200kA	50kA	720	4,075	1,990	8	14
L50QS100	100	500	500	200kA	50kA	905	4,577	2,313	9	17
L50QS125	125	500	500	200kA	50kA	1,503	7,655	4,815	10	17
L50QS150	150	500	500	200kA	50kA	2,382	11,100	7,190	12	21
L50QS175	175	500	500	200kA	50kA	3,148	16,500	9,900	14	25
L50QS200	200	500	500	200kA	50kA	4,102	18,233	11,567	17	32
L50QS225	225	500	500	200kA	50kA	5,379	25,300	16,700	19	35
L50QS250	250	500	500	200kA	50kA	7,094	31,350	22,500	20	37
L50QS275	275	500	500	200kA	50kA	9,655	40,175	30,177	21	39
L50QS300	300	500	500	200kA	50kA	11,240	53,800	36,150	25	46
L50QS325	325	500	500	200kA	50kA	13,183	56,250	41,000	27	51
L50QS350	350	500	500	200kA	50kA	14,246	68,850	44,800	30	61
L50QS400	400	500	500	200kA	50kA	21,155	100,300	67,300	33	65
L50QS450	450	500	500	200kA	50kA	26,425	121,000	84,650	35	63
L50QS500	500	500	500	200kA	50kA	31,747	141,000	103,500	39	72
L50QS600	600	500	500	200kA	50kA	43,922	193,500	128,000	49	92
L50QS700	700	500	500	200kA	50kA	75,597	314,000	230,000	51	92
L50QS800	800	500	500	200kA	50kA	92,717	393,500	280,000	63	117

L50QS SERIES HIGH-SPEED ROUND BODY FUSES

Ordering Information

SERIES	AMPERAGE RATING	AMPERE CODE	CATALOG NUMBER	ORDERING NUMBER	PACK QUANTITY	UPC
L50QS	35	035	L50QS035	L50QS035.T	10 Pcs/ Box	07945885991
L50QS	40	040	L50QS040	L50QS040.T	10 Pcs/ Box	07945885992
L50QS	50	050	L50QS050	L50QS050.T	10 Pcs/ Box	07945885993
L50QS	60	060	L50QS060	L50QS060.T	10 Pcs/ Box	07945885994
L50QS	70	070	L50QS070	L50QS070.T	10 Pcs/ Box	07945885995
L50QS	80	080	L50QS080	L50QS080.T	10 Pcs/ Box	07945885996
L50QS	90	090	L50QS090	L50QS090.T	10 Pcs/ Box	07945885997
L50QS	100	100	L50QS100	L50QS100.T	10 Pcs/ Box	07945885998
L50QS	125	125	L50QS125	L50QS125.V	5 Pcs/ Box	07945885999
L50QS	150	150	L50QS150	L50QS150.V	5 Pcs/ Box	07945886000
L50QS	175	175	L50QS175	L50QS175.V	5 Pcs/ Box	07945886001
L50QS	200	200	L50QS200	L50QS200.V	5 Pcs/ Box	07945886002
L50QS	225	225	L50QS225	L50QS225.V	5 Pcs/ Box	07945886003
L50QS	250	250	L50QS250	L50QS250.V	5 Pcs/ Box	07945886004
L50QS	275	275	L50QS275	L50QS275.V	5 Pcs/ Box	07945886005
L50QS	300	300	L50QS300	L50QS300.V	5 Pcs/ Box	07945886006
L50QS	325	325	L50QS325	L50QS325.V	5 Pcs/ Box	07945886011
L50QS	350	350	L50QS350	L50QS350.V	5 Pcs/ Box	07945886007
L50QS	400	400	L50QS400	L50QS400.V	5 Pcs/ Box	07945886008
L50QS	450	450	L50QS450	L50QS450.X	1 Pc/ Box	07945886009
L50QS	500	500	L50QS500	L50QS500.X	1 Pc/ Box	07945886010
L50QS	600	600	L50QS600	L50QS600.X	1 Pc/ Box	07945886012
L50QS	700	700	L50QS700	L50QS700.X	1 Pc/ Box	07945886013
L50QS	800	800	L50QS800	L50QS800.X	1 Pc/ Box	07945886014

L50QS SERIES HIGH-SPEED ROUND BODY FUSES

Dimensions Millimeters [inches]

Document Number: OL-L50QS000

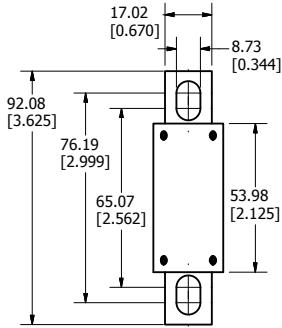

35-100A

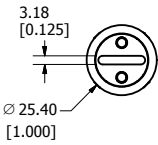

Stud Size: M8 (5/16")

Recommended Torque: 15 Nm (132.76 in-lb)

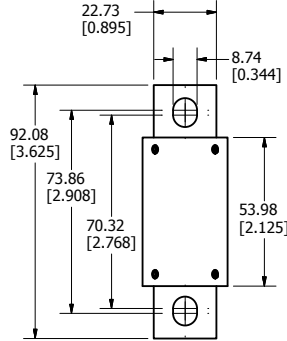

125-200A

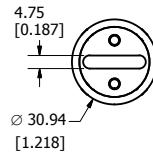

Stud Size: M8 (5/16")

Recommended Torque: 15 Nm (132.76 in-lb)

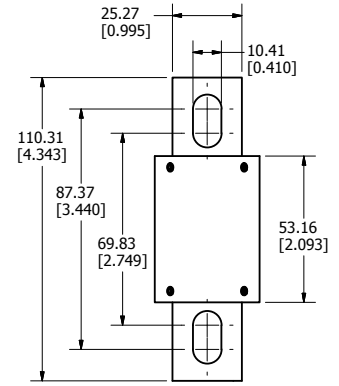

225-400A

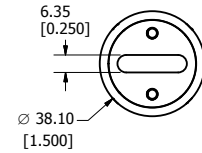

Stud Size: M8 (5/16")

Recommended Torque: 15 Nm (132.76 in-lb)

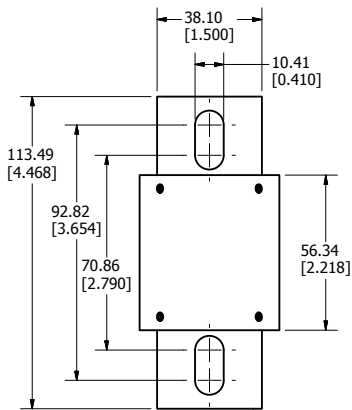

450-600A

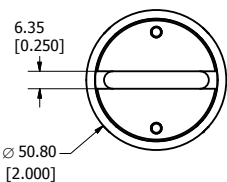

Stud Size: M8 (5/16")

Recommended Torque: 15 Nm (132.76 in-lb)

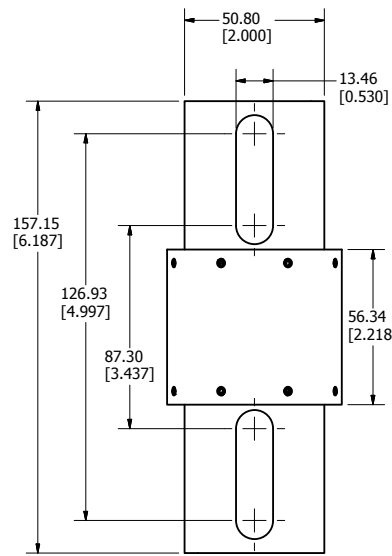

700-800A

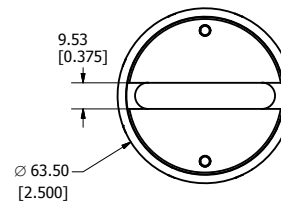

Stud Size: M12 (1/2")

Recommended Torque: 54 Nm (477.94 in-lb)

L50QS SERIES HIGH-SPEED ROUND BODY FUSES

Time Current Curve L50QS Series

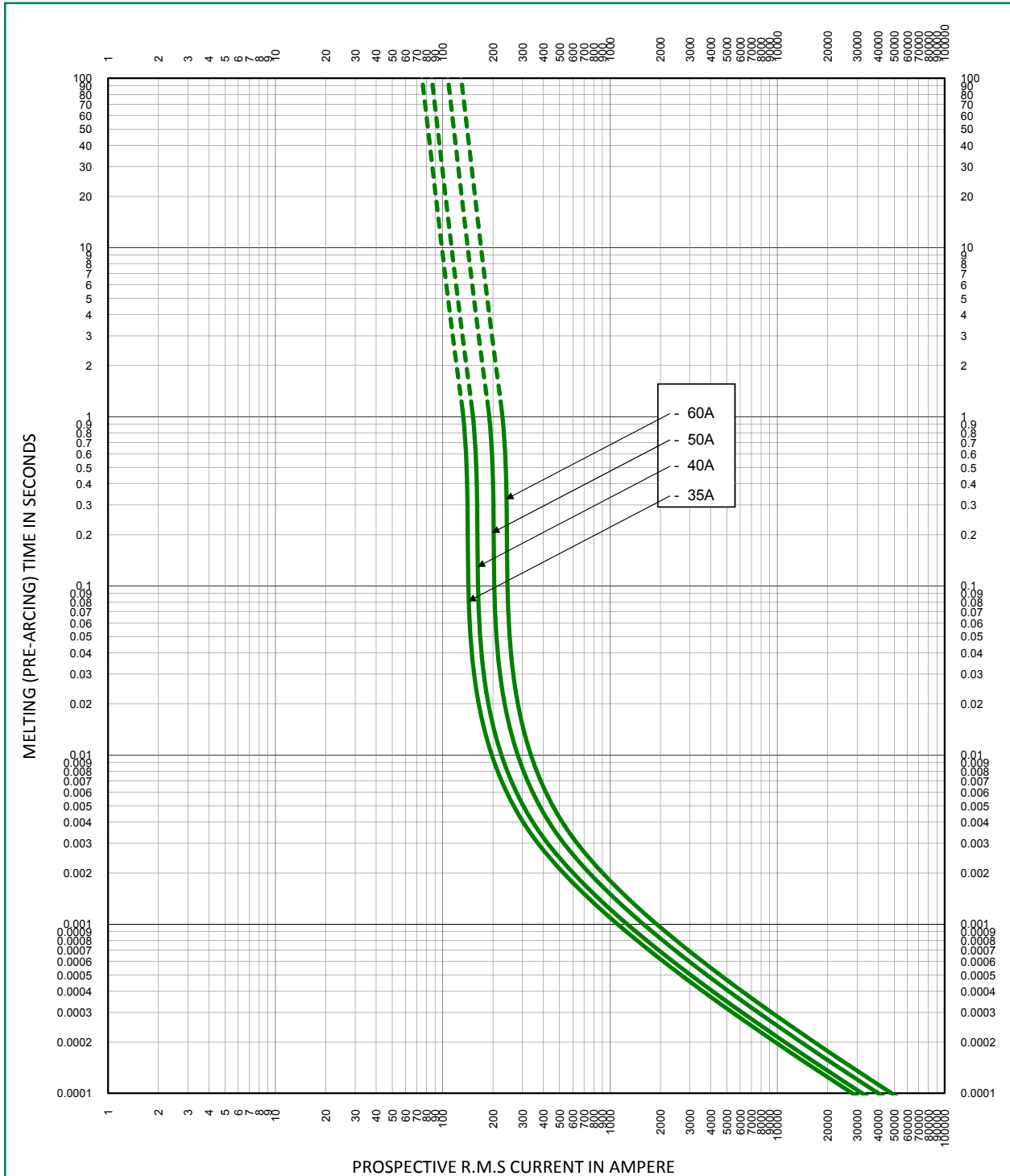

L50QS SERIES HIGH-SPEED ROUND BODY FUSES

Time Current Curve L50QS Series

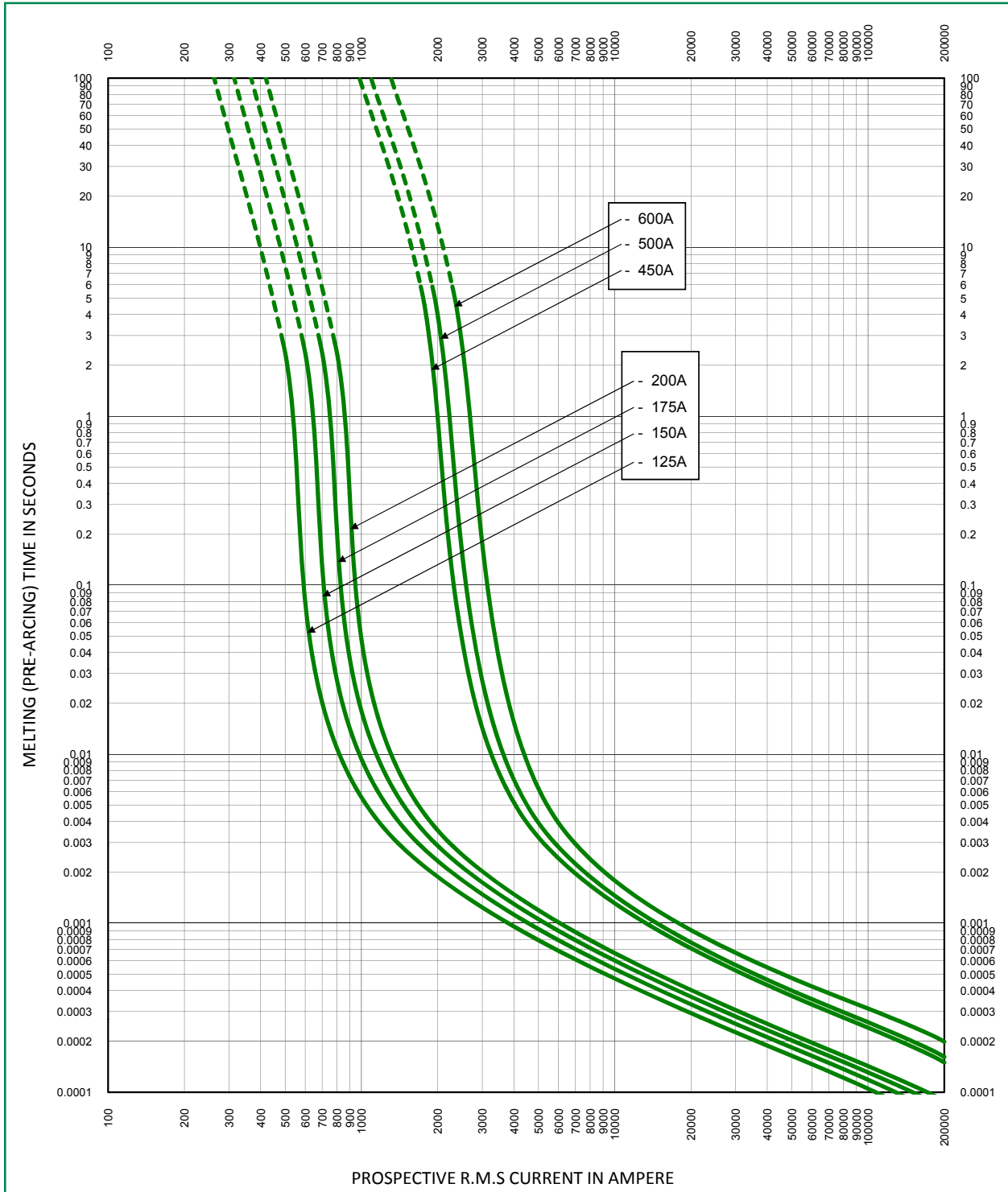

L50QS SERIES HIGH-SPEED ROUND BODY FUSES

Time Current Curve L50QS Series

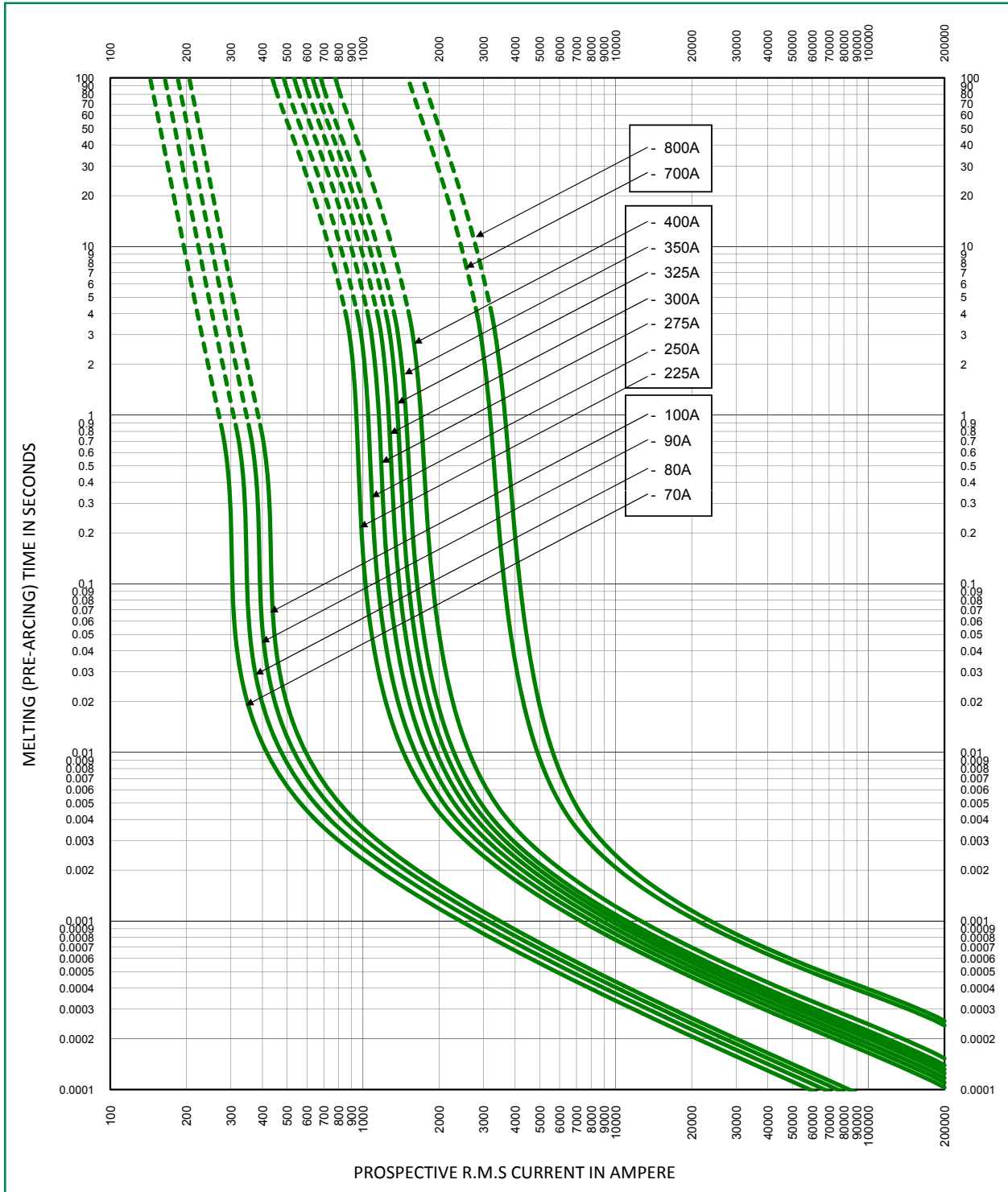

L50QS SERIES HIGH-SPEED ROUND BODY FUSES

Peak Let-Through Curve L50QS Series

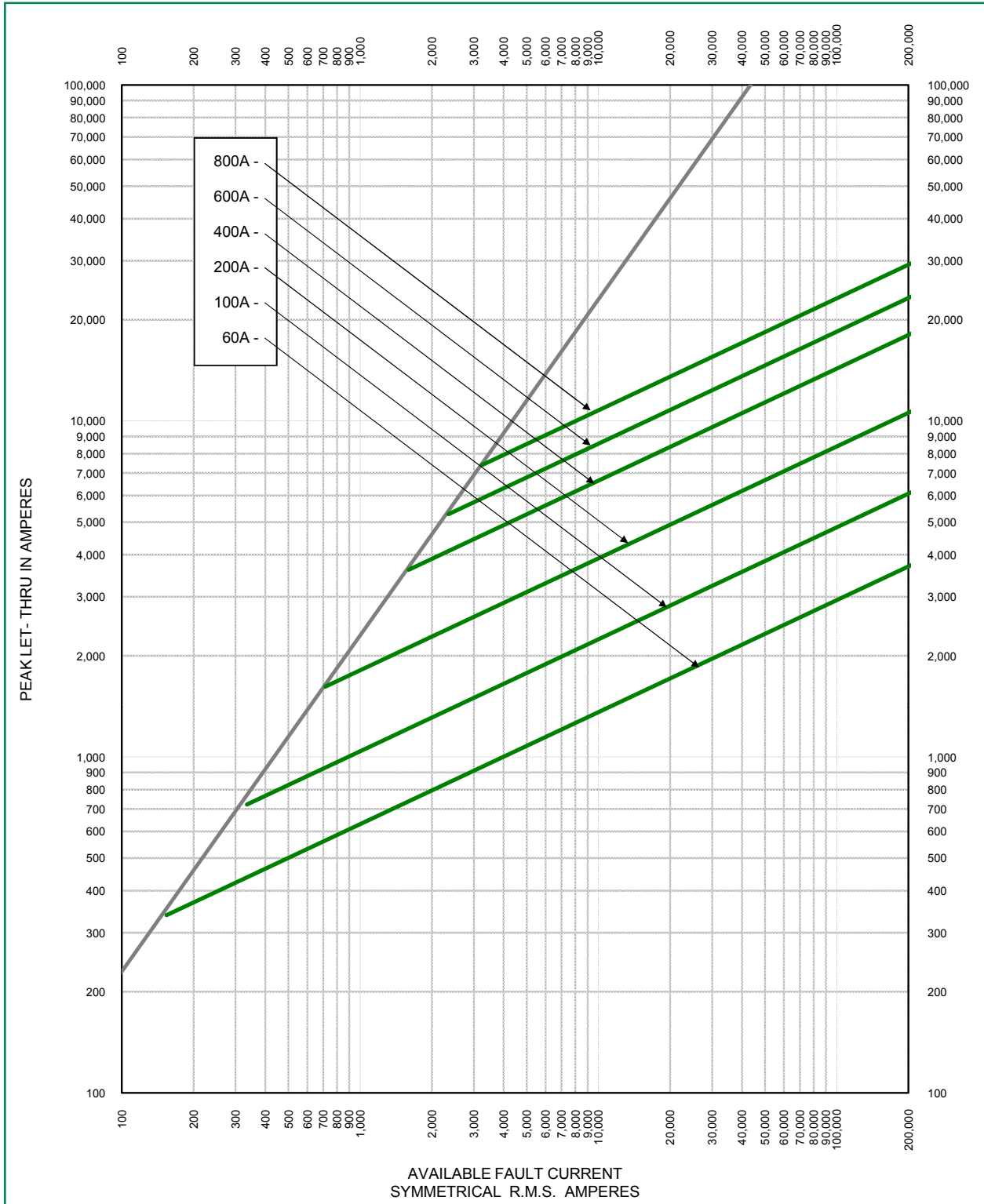

L50QS SERIES HIGH-SPEED ROUND BODY FUSES

Temperature De-rating Curve (Temperature of Air Immediately Surrounding Fuse)
L50QS Series

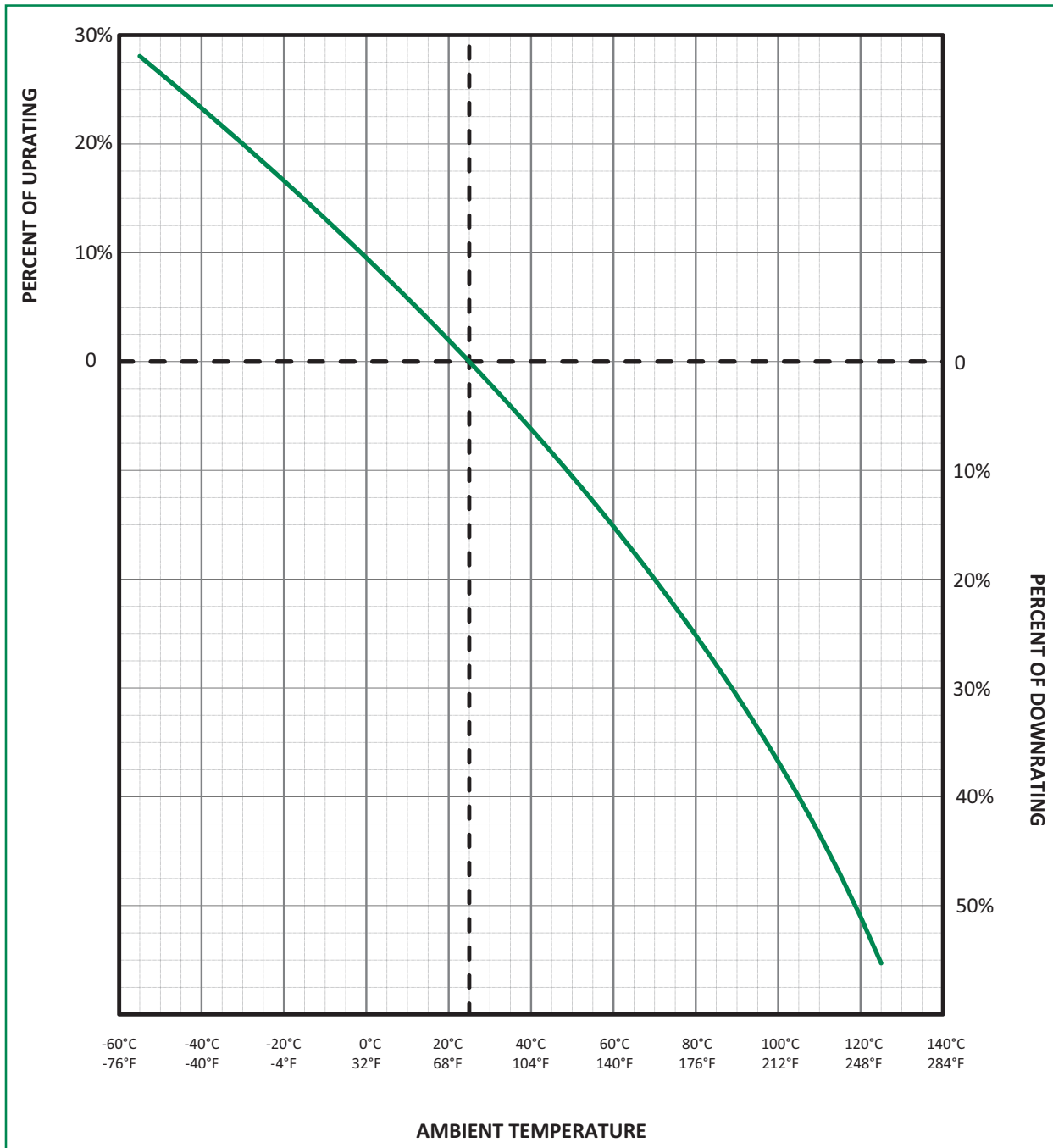

L50QS SERIES HIGH-SPEED ROUND BODY FUSES

Total Clearing I²t Correction Factor Curve

L50QS Series

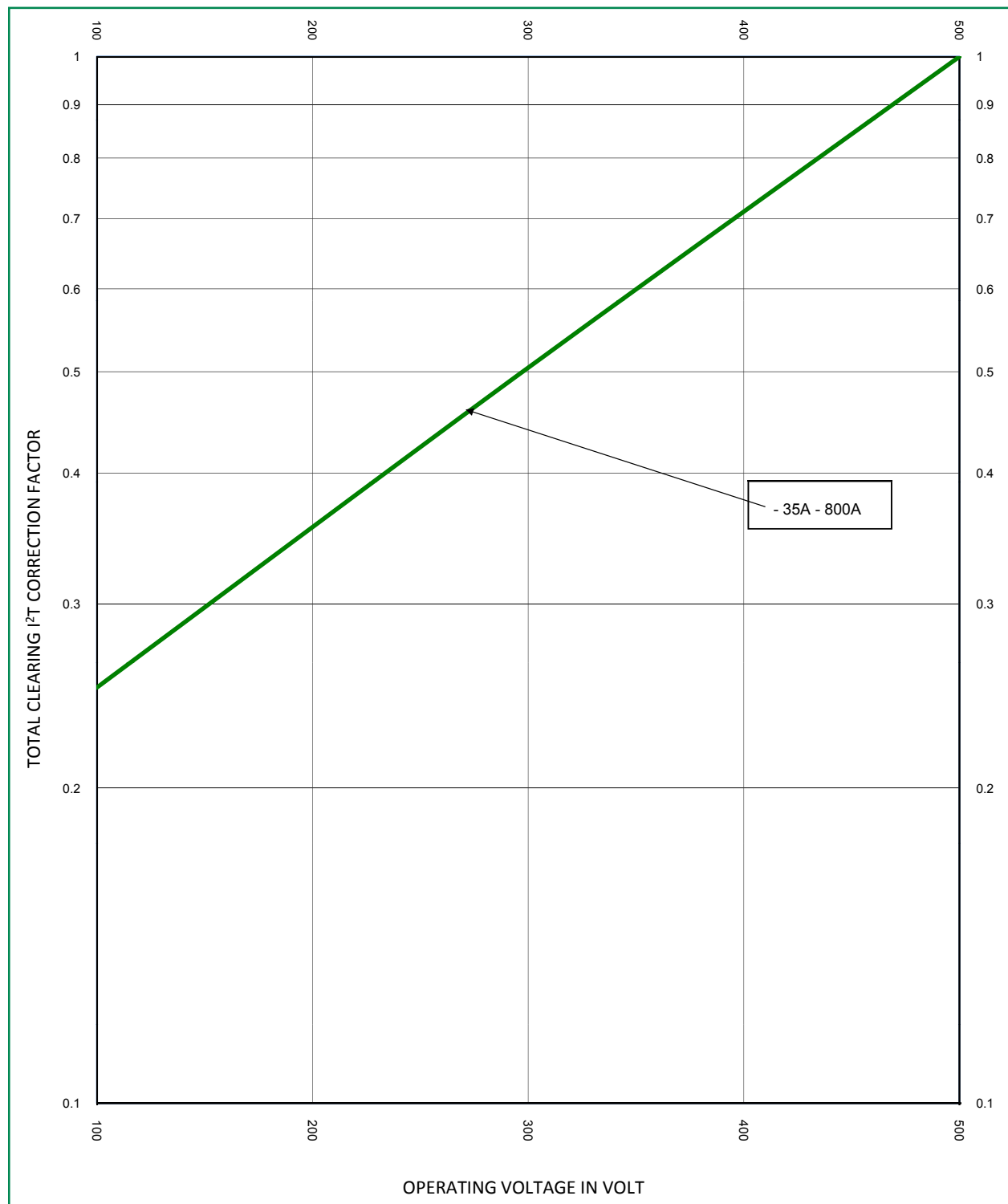

L50QS SERIES HIGH-SPEED ROUND BODY FUSES

Watts Loss Correction Factor Curve

L50QS Series

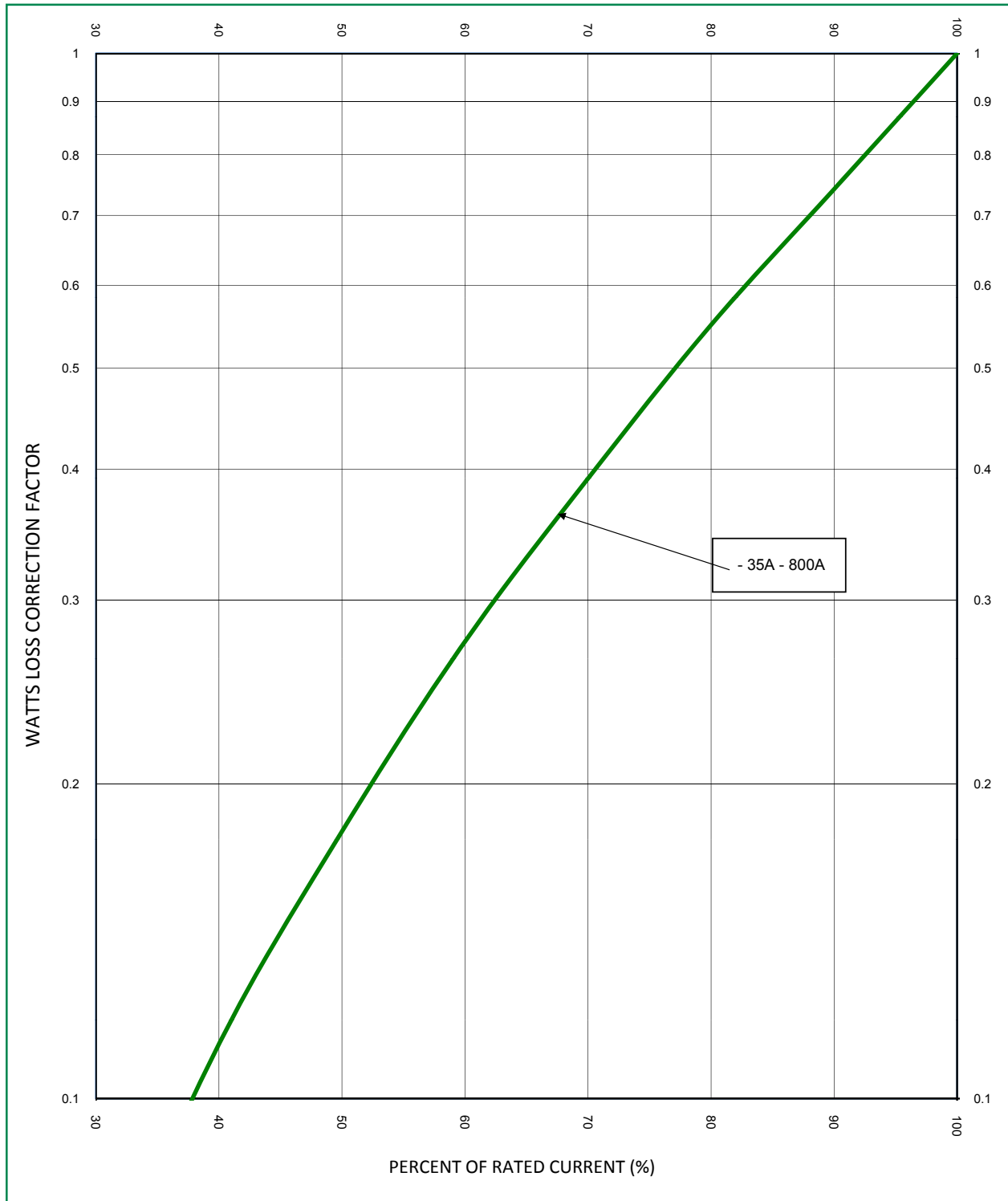

L50QS SERIES HIGH-SPEED ROUND BODY FUSES

Peak Arc Voltage Curve

L50QS Series

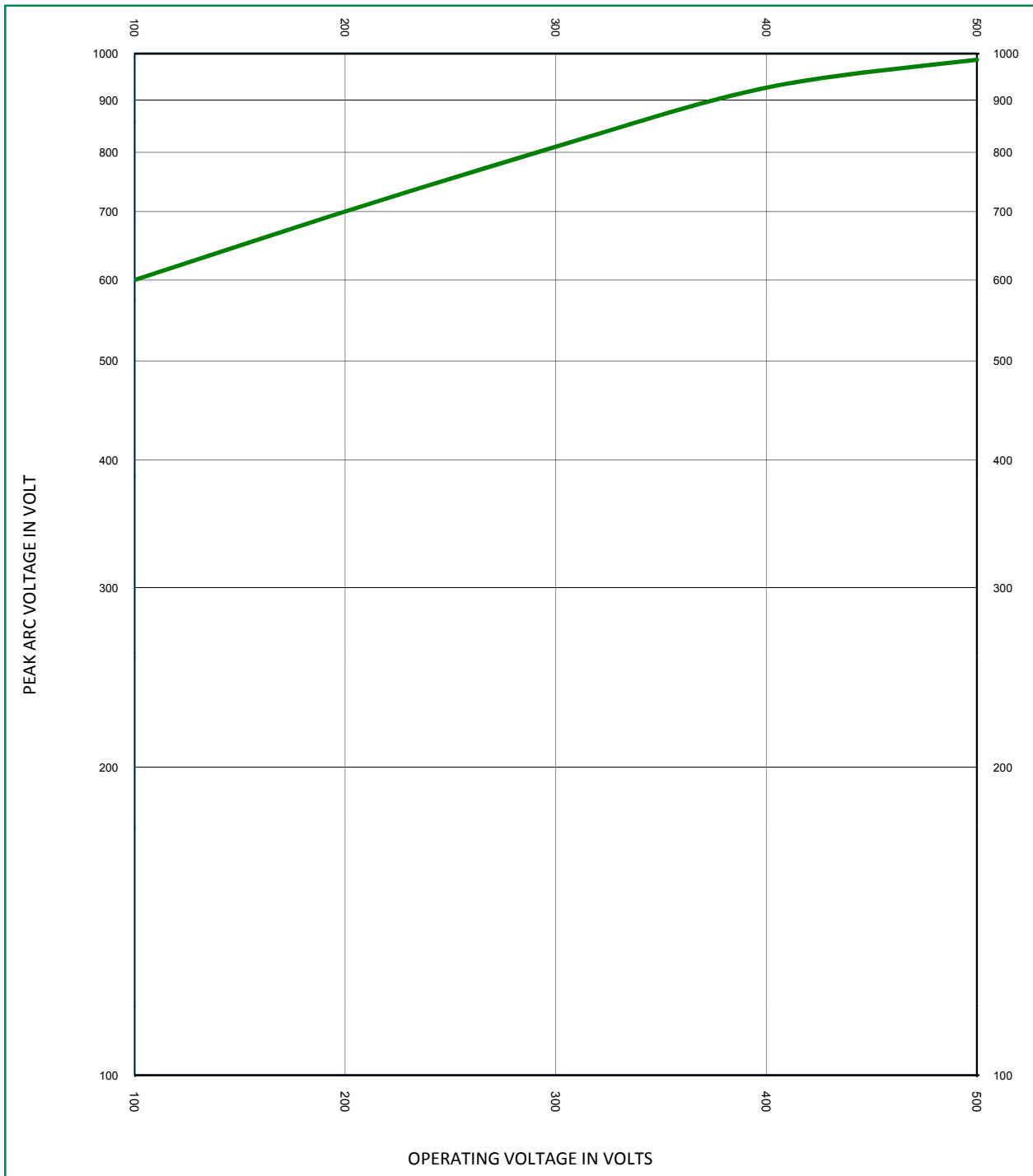

Disclaimer Notice - Littelfuse products are not designed for, and shall not be used for, any purpose (including, without limitation, automotive, military, aerospace, medical, life-saving, life-sustaining or nuclear facility applications, devices intended for surgical implant into the body, or any other application in which the failure or lack of desired operation of the product may result in personal injury, death, or property damage) other than those expressly set forth in applicable Littelfuse product documentation. Warranties granted by Littelfuse shall be deemed void for products used for any purpose not expressly set forth in applicable Littelfuse documentation. Littelfuse shall not be liable for any claims or damages arising out of products used in applications not expressly intended by Littelfuse as set forth in applicable Littelfuse documentation. The sale and use of Littelfuse products is subject to Littelfuse Terms and Conditions of Sale, unless otherwise agreed by Littelfuse.

Littelfuse.com/Product-Disclaimer

Looking for pricing, stock, or lifecycle information?

Click below to explore more details on WIN SOURCE:

 [View L50QS100.T on WIN SOURCE](#)

 [Littelfuse Inc. Information](#)

Optimize Your Supply Chain with WIN SOURCE Solutions

-  Global Sourcing Solution
-  Obsolete Management
-  Cost Control Management
-  Shortage Management
-  Alternative Solution
-  Excess Inventory Management