



**THE DATASHEET OF
DMP2100UCB9-7**



DUAL P-CHANNEL ENHANCEMENT MODE MOSFET
Product Summary (Typ. @ $V_{GS} = -4.5V$, $T_A = +25^{\circ}C$)

V_{DSS}	$R_{DS(on)}$	Q_g	Q_{gd}	I_D
-20V	80m Ω	3.3nC	0.6nC	-4A

Description

This new generation MOSFET is designed to minimize the on-state resistance ($R_{D1D2(ON)}$) and yet maintain superior switching performance, making it ideal for high-efficiency power management applications.

Applications

- Battery Management
- Load Switch
- Battery Protection

Features and Benefits

- LD-MOS Technology with the Lowest Figure of Merit:
 $R_{DS(on)} = 80m\Omega$ to Minimize On-State Losses
 $Q_g = 3.3nC$ for Ultra-Fast Switching
- $V_{gs(th)} = -0.7V$ typ. for a Low Turn-On Potential
- CSP with Footprint 1.5mm x 1.5mm
- Height = 0.62mm for Low Profile
- ESD = 3kV HBM Protection of Gate
- Totally Lead-Free & Fully RoHS Compliant (Notes 1 & 2)**
- Halogen and Antimony Free. "Green" Device (Note 3)**
- Qualified to AEC-Q101 Standards for High Reliability**

Mechanical Data

- Case: U-WLB1515-9
- Terminal Connections: See Diagram Below
- Weight: 0.0018 grams (Approximate)

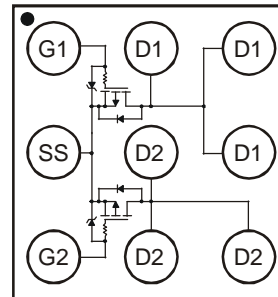

Top View

Ordering Information (Note 4)

Part Number	Case	Packaging
DMP2100UCB9-7	U-WLB1515-9	3,000/Tape & Reel

- Notes:
- No purposely added lead. Fully EU Directive 2002/95/EC (RoHS) & 2011/65/EU (RoHS 2) compliant.
 - See http://www.diodes.com/quality/lead_free.html for more information about Diodes Incorporated's definitions of Halogen- and Antimony-free, "Green" and Lead-free.
 - Halogen- and Antimony-free "Green" products are defined as those which contain <900ppm bromine, <900ppm chlorine (<1500ppm total Br + Cl) and <1000ppm antimony compounds.
 - For packaging details, go to our website at <http://www.diodes.com/products/packages.html>.

Marking Information

U-WLB1515-9

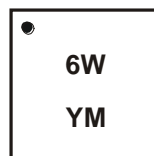

6W = Product Type Marking Code
 YM = Date Code Marking
 Y = Year (ex: Y = 2011)
 M = Month (ex: 9 = September)

Date Code Key

Year	2012	2013	2014	2015	2016	2017	2018
Code	Z	A	B	C	D	E	F

Month	Jan	Feb	Mar	Apr	May	Jun	Jul	Aug	Sep	Oct	Nov	Dec
Code	1	2	3	4	5	6	7	8	9	O	N	D

Maximum Ratings (@T_A = +25°C, unless otherwise specified.)

Characteristic	Symbol	Value	Units
Drain-Source Voltage	V _{D1D2}	-20	V
Gate-Source Voltage	V _{GS}	-6	V
Continuous Drain Current (Note 5) V _{GS} = -4.5V	Steady State	T _C = +25°C	-3.0
		T _C = +70°C	-2.1
Continuous Drain Current (Note 6) V _{GS} = -4.5V	Steady State	T _C = +25°C	-4.0
		T _C = +70°C	-3.0
Continuous Source Pin Current (Note 6)	I _S	-2.0	A
Continuous Gate Clamp Current (Note 6)	I _G	-0.4	A
Pulsed Source Pin Current (Pulse duration 10μs, duty cycle ≤ 1%)	I _{SM}	-15	A
Pulsed Drain Current (Pulse duration 10μs, duty cycle ≤ 1%)	I _{DM}	-28	A
Pulsed Gate Clamp Current (Pulse duration 10μs, duty cycle ≤ 1%)	I _{GM}	-6	A

Thermal Characteristics (@T_A = +25°C, unless otherwise specified.)

Characteristic	Symbol	Value	Units
Total Power Dissipation (Note 5)	P _D	0.8	W
Total Power Dissipation (Note 6)	P _D	1.6	W
Thermal Resistance, Junction to Ambient (Note 5)	R _{θJA}	152	°C/W
Thermal Resistance, Junction to Ambient (Note 6)	R _{θJA}	65	°C/W
Operating and Storage Temperature Range	T _J , T _{STG}	-55 to +150	°C

Electrical Characteristics (@T_A = +25°C, unless otherwise specified.)

Characteristic	Symbol	Min	Typ	Max	Unit	Test Condition
OFF CHARACTERISTICS (Note 7)						
Drain-Source Breakdown Voltage	BV _{D1D2}	-20	—	—	V	V _{GS} = 0V, I _{D1D2} = -250μA
Gate-Source Breakdown Voltage	BV _{GSS}	-6.1	—	—	V	I _{GS} = -250μA, V _{D1D2} = 0V
Zero Gate Voltage Drain Current @T _C = +25°C	I _{DDS}	—	—	-1	μA	V _{D1D2} = -16V, V _{GS} = 0V
Gate-Source Leakage	I _{GSS}	—	—	-100	nA	V _{GS} = -6V, V _{DS} = 0V
ON CHARACTERISTICS (Note 7)						
Gate Threshold Voltage	V _{GS(th)}	-0.4	-0.7	-0.9	V	V _{D1D2} = V _{GS} , I _{DS} = -250μA
Static Drain-Source On-Resistance	R _{D1D2(ON)}	—	80	100	mΩ	V _{GS} = -4.5V, I _{D1D2} = -1A
		—	105	130		V _{GS} = -2.5V, I _{D1D2} = -1A
		—	140	175		V _{GS} = -1.8V, I _{D1D2} = -1A
Forward Transfer Admittance	Y _{fs}	—	5.3	—	S	V _{D1D2} = -10V, I _{D1D2} = -1A
DIODE CHARACTERISTICS						
Diode Forward Voltage (Note 6)	V _{SD}	—	-0.7	-1	V	V _{GS} = 0V, I _{D1D2} = -1A
Reverse Recovery Charge	Q _{rr}	—	18	—	nC	V _{dd} = -9.5V, I _F = -1A, di/dt = 200A/μs
Reverse Recovery Time	t _{rr}	—	34	—	ns	
DYNAMIC CHARACTERISTICS (Note 8)						
Input Capacitance	C _{iss}	—	232	310	pF	V _{D1D2} = -10V, V _{GS} = 0V, f = 1.0MHz
Output Capacitance	C _{oss}	—	107	150	pF	
Reverse Transfer Capacitance	C _{rss}	—	43.5	55	pF	
Total Gate Charge (4.5V)	Q _g	—	3.3	4.2	nC	V _{GS} = -4.5V, V _{D1D2} = -10V, I _{D1D2} = -1A
Gate-Source Charge	Q _{gs}	—	0.3	—	nC	
Gate-Drain Charge	Q _{gd}	—	0.6	—	nC	
Gate Charge at V _{th}	Q _{g(th)}	—	0.2	—	nC	
Turn-On Delay Time	t _{D(on)}	—	8.5	—	ns	V _{D1D2} = -10V, V _{GS} = -4.5V, I _{D1D2} = -1A, R _G = 30Ω,
Turn-On Rise Time	t _r	—	7.0	—	ns	
Turn-Off Delay Time	t _{D(off)}	—	47	—	ns	
Turn-Off Fall Time	t _f	—	28	—	ns	

- Notes:
- Device mounted on FR-4 PCB with minimum recommended pad layout.
 - Device mounted on FR4 material with 1-inch² (6.45-cm²), 2-oz. (0.071-mm thick) Cu.
 - Short duration pulse test used to minimize self-heating effect.
 - Guaranteed by design. Not subject to production testing.

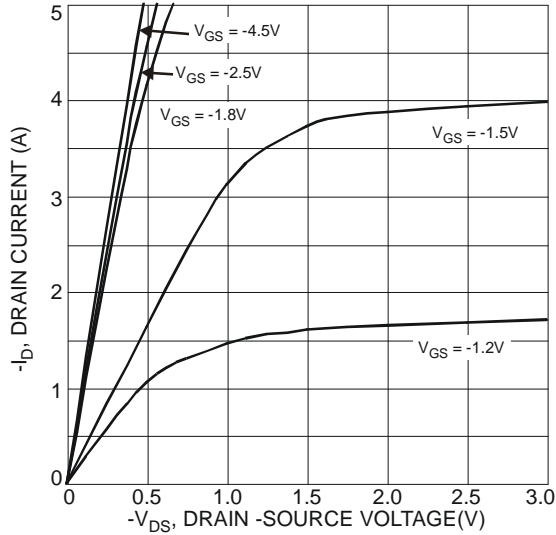

Fig. 1 Typical Output Characteristics

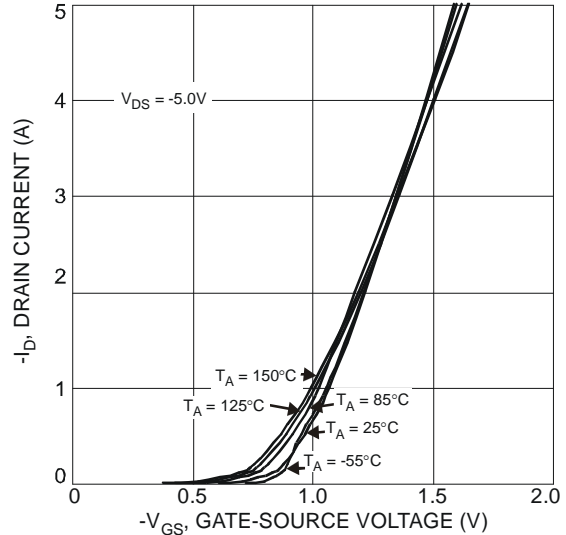

Fig. 2 Typical Transfer Characteristics

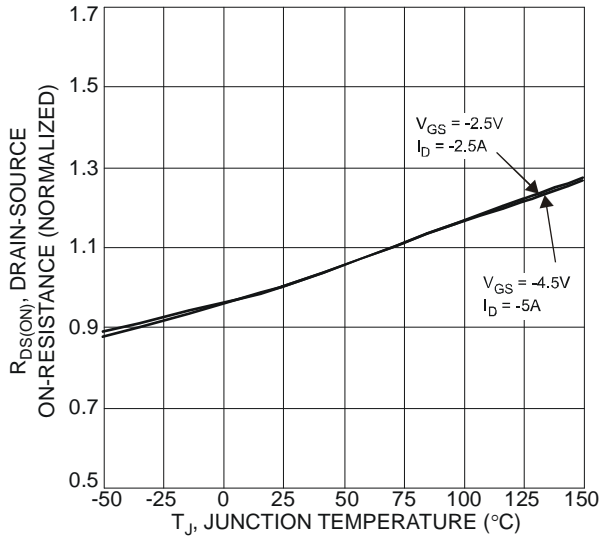

Fig. 3 On-Resistance Variation with Temperature

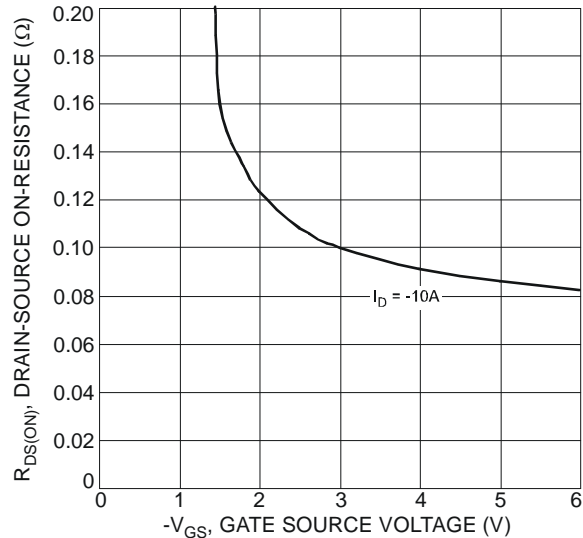

Fig. 4 Typical On-Resistance vs. Drain Current and Gate Voltage

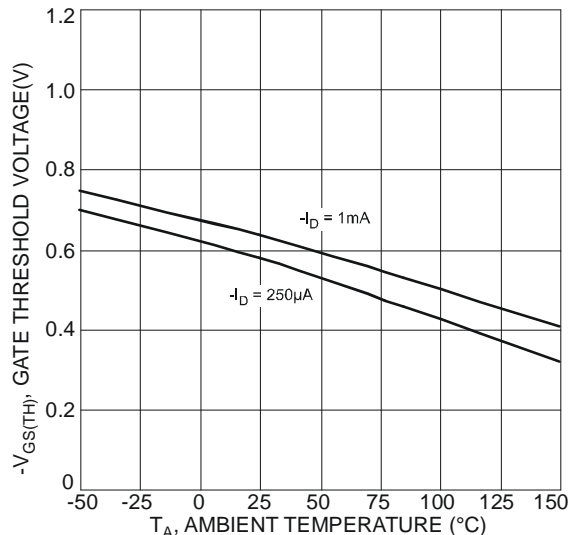

Fig. 5 Gate Threshold Variation vs. Ambient Temperature

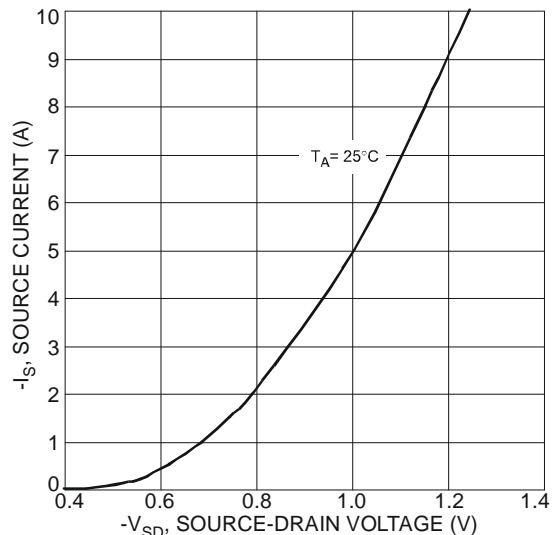

Fig. 6 Diode Forward Voltage vs. Current

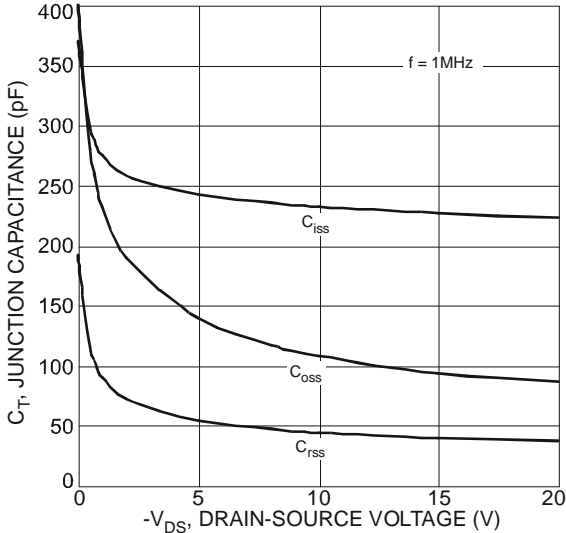

Fig. 7 Typical Junction Capacitance

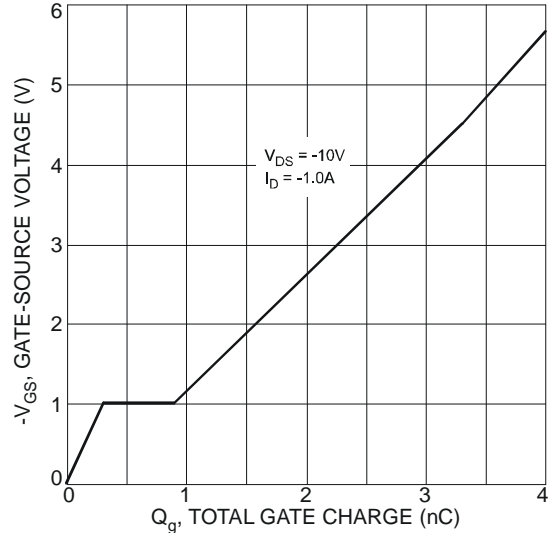

Fig. 8 Gate-Charge Characteristics

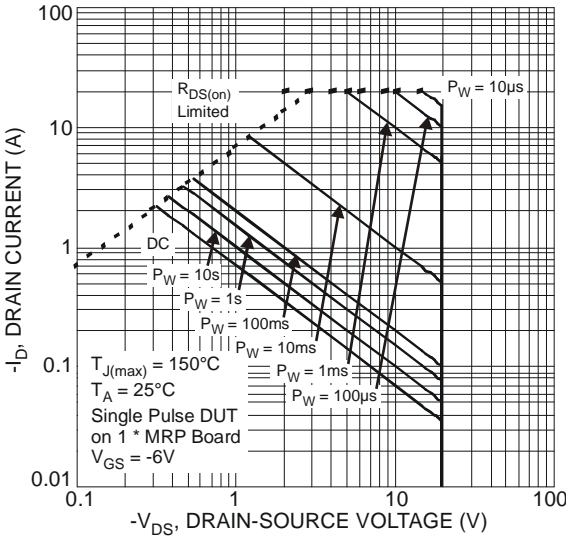

Fig. 9 SOA, Safe Operation Area

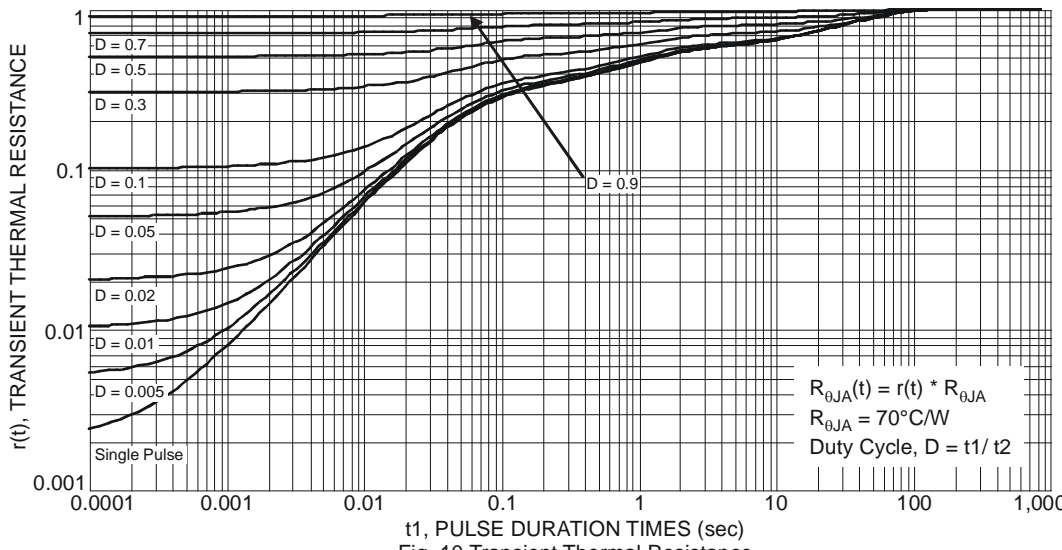
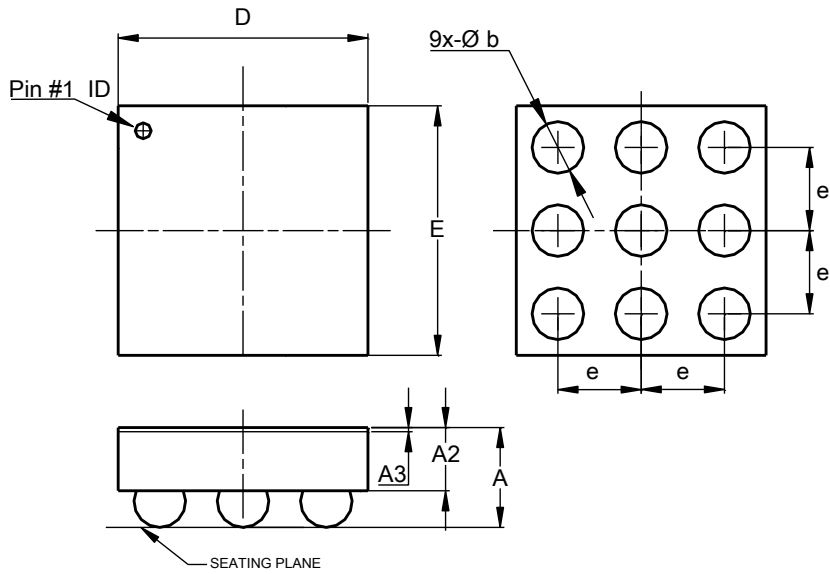

Fig. 10 Transient Thermal Resistance

Package Outline Dimensions

Please see AP02002 at <http://www.diodes.com/datasheets/ap02002.pdf> for the latest version.



U-WLB1515-9			
Dim	Min	Max	Typ
A	--	0.62	--
A2	--	0.36	0.36
A3	0.020	0.030	0.025
b	0.27	0.37	0.32
D	1.47	1.50	1.49
E	1.47	1.50	1.49
e	--	--	0.50
All Dimensions in mm			

Suggested Pad Layout

Please see AP02001 at <http://www.diodes.com/datasheets/ap02001.pdf> for the latest version.

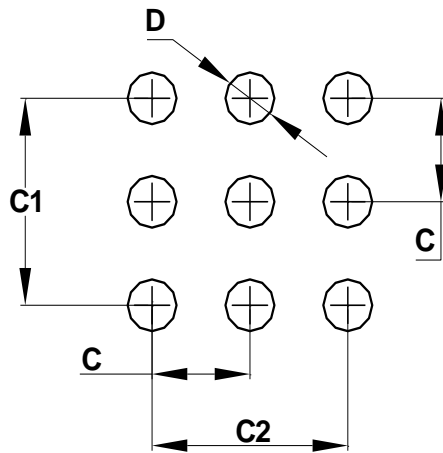

Dimensions	Value (in mm)
C	0.50
C1	1.00
C2	1.00
D	0.25

IMPORTANT NOTICE

DIODES INCORPORATED MAKES NO WARRANTY OF ANY KIND, EXPRESS OR IMPLIED, WITH REGARDS TO THIS DOCUMENT, INCLUDING, BUT NOT LIMITED TO, THE IMPLIED WARRANTIES OF MERCHANTABILITY AND FITNESS FOR A PARTICULAR PURPOSE (AND THEIR EQUIVALENTS UNDER THE LAWS OF ANY JURISDICTION).

Diodes Incorporated and its subsidiaries reserve the right to make modifications, enhancements, improvements, corrections or other changes without further notice to this document and any product described herein. Diodes Incorporated does not assume any liability arising out of the application or use of this document or any product described herein; neither does Diodes Incorporated convey any license under its patent or trademark rights, nor the rights of others. Any Customer or user of this document or products described herein in such applications shall assume all risks of such use and will agree to hold Diodes Incorporated and all the companies whose products are represented on Diodes Incorporated website, harmless against all damages.

Diodes Incorporated does not warrant or accept any liability whatsoever in respect of any products purchased through unauthorized sales channel. Should Customers purchase or use Diodes Incorporated products for any unintended or unauthorized application, Customers shall indemnify and hold Diodes Incorporated and its representatives harmless against all claims, damages, expenses, and attorney fees arising out of, directly or indirectly, any claim of personal injury or death associated with such unintended or unauthorized application.

Products described herein may be covered by one or more United States, international or foreign patents pending. Product names and markings noted herein may also be covered by one or more United States, international or foreign trademarks.

This document is written in English but may be translated into multiple languages for reference. Only the English version of this document is the final and determinative format released by Diodes Incorporated.

LIFE SUPPORT

Diodes Incorporated products are specifically not authorized for use as critical components in life support devices or systems without the express written approval of the Chief Executive Officer of Diodes Incorporated. As used herein:

A. Life support devices or systems are devices or systems which:

1. are intended to implant into the body, or
2. support or sustain life and whose failure to perform when properly used in accordance with instructions for use provided in the labeling can be reasonably expected to result in significant injury to the user.

B. A critical component is any component in a life support device or system whose failure to perform can be reasonably expected to cause the failure of the life support device or to affect its safety or effectiveness.

Customers represent that they have all necessary expertise in the safety and regulatory ramifications of their life support devices or systems, and acknowledge and agree that they are solely responsible for all legal, regulatory and safety-related requirements concerning their products and any use of Diodes Incorporated products in such safety-critical, life support devices or systems, notwithstanding any devices- or systems-related information or support that may be provided by Diodes Incorporated. Further, Customers must fully indemnify Diodes Incorporated and its representatives against any damages arising out of the use of Diodes Incorporated products in such safety-critical, life support devices or systems.

Copyright © 2015, Diodes Incorporated

www.diodes.com

Looking for pricing, stock, or lifecycle information?

Click below to explore more details on WIN SOURCE:

 [View DMP2100UCB9-7 on WIN SOURCE](#)

 [Diodes Incorporated](#) Information

Optimize Your Supply Chain with WIN SOURCE Solutions

-  Global Sourcing Solution
-  Obsolete Management
-  Cost Control Management
-  Shortage Management
-  Alternative Solution
-  Excess Inventory Management