



**THE DATASHEET OF
AP22818AKAWT-7**



Description

The DIODES™ AP22816/17/18 is a single-channel, current-limited, integrated high-side power switch optimized for Universal Serial Bus (USB) and other hot-swap applications. The family of devices complies with USB standards and is available with both polarities of enable input.

The device has fast short-circuit response time for improved overall system robustness, and has an integrated output discharge function to ensure completely controlled discharging of the output voltage capacitor. They provide a complete protection solution for applications subject to heavy capacitive loads and the prospect of short circuit, and offer reverse current blocking, overcurrent, overtemperature and short-circuit protection, as well as controlled rise time and undervoltage lockout functionality. A 6ms deglitch capability on the open-drain flag output prevents false overcurrent reporting and does not require any external components.

The AP22816/17/18 is available in the standard Green and RoHS compliant TSOT25 and MSOP-8 packages.

Features

- Input Voltage Range: 2.7V to 5.5V
- 75mΩ On-resistance
- Built-in Soft-start with 0.6ms Typical Rise Time
- Fault Report (FLG) with Blanking Time (6ms Typ.)
- ESD Protection: 2kV HBM, 500V CDM
- Logic Level Enable Pin: Available with Active-high or Active-low Versions
- Protections:
 - Overcurrent Protection with Auto Recovery
 - Short-Circuit Protection with Auto Recovery
 - Overtemperature Protection with Auto Recovery
 - Output Reverse Current / Voltage Protection
- Thermally-Efficient Low Profile Package
- Moisture Sensitivity: Level 1 per J-STD-020
- Terminals:
 - TSOT-25: Finish – Matte Tin Plated Leads, Solderable per MIL-STD-202, Method 208 (e3)
 - MSOP-8: Finish – Matte Tin Plated Leads, Solderable per MIL-STD-202, Method 208 (e3)
- Weight:
 - TSOT25: 0.013 grams (Approximate)
 - MSOP-8: 0.027grams(Approximate)
- UL Recognized, File Number E322375
- IEC60950-1 CB Scheme Certified
- **Totally Lead-Free & Fully RoHS Compliant (Notes 1 & 2)**
- **Halogen and Antimony Free. “Green” Device (Note 3)**
- **For automotive applications requiring specific change control (i.e. parts qualified to AEC-Q100/101/104/200, PPAP capable, and manufactured in IATF 16949 certified facilities), please [contact us](mailto:contact@diodes.com) or your local Diodes representative. <https://www.diodes.com/quality/product-definitions/>**

Notes: 1. No purposely added lead. Fully EU Directive 2002/95/EC (RoHS), 2011/65/EU (RoHS 2) & 2015/863/EU (RoHS 3) compliant.
 2. See <https://www.diodes.com/quality/lead-free/> for more information about Diodes Incorporated's definitions of Halogen- and Antimony-free, "Green" and Lead-free.
 3. Halogen- and Antimony-free "Green" products are defined as those which contain <900ppm bromine, <900ppm chlorine (<1500ppm total Br + Cl) and <1000ppm antimony compounds.

Pin Assignments

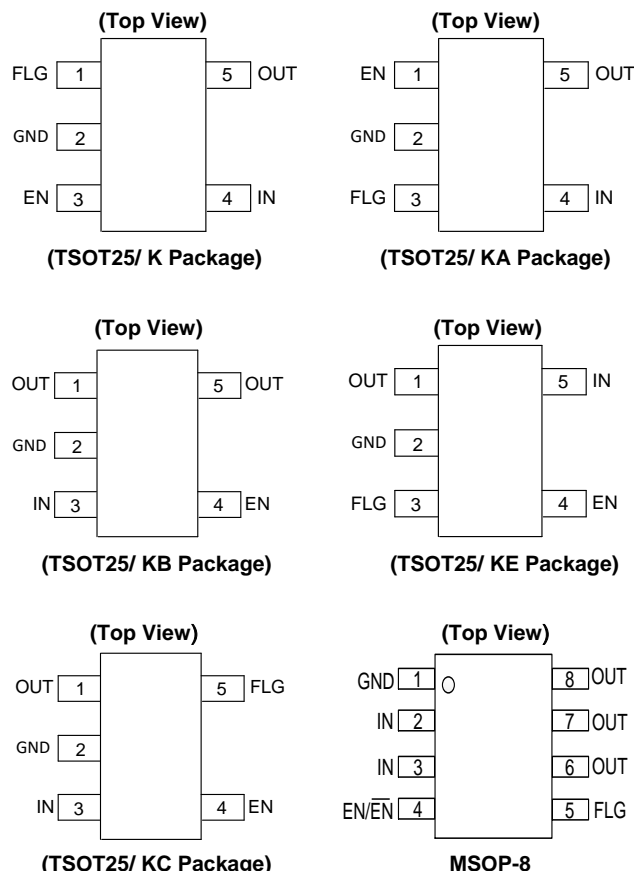

Applications

- Integrated load switches in Ultrabook PCs
- Power up/down sequencing in Ultrabook PCs
- Notebooks
- Netbooks
- Set-top boxes
- SSD (solid state drives)
- Consumer electronics
- Tablet PCs
- Telecom systems

Typical Applications Circuit

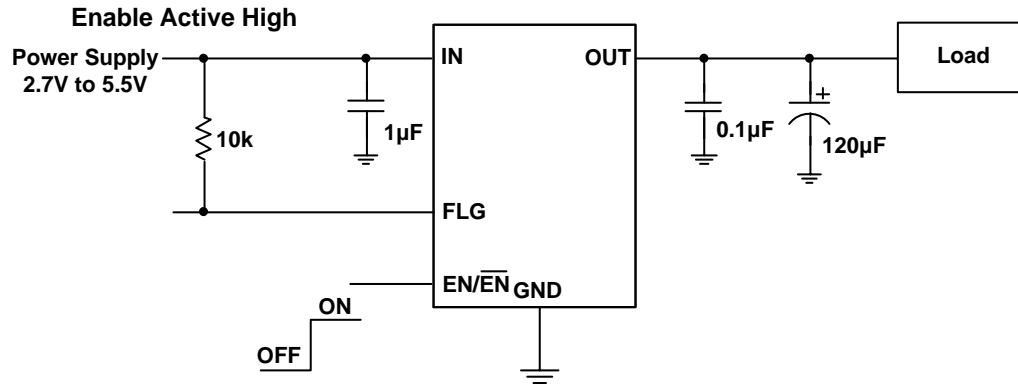

Note: If 1µF input cap. Will lead to large V_{IN} spike, it's recommended to use 10µF capacitor instead.

Pin Descriptions

Pin Number		Pin Name	Function
TSOT25	MSOP-8		
5(K/KA)	6, 7, 8	OUT	Voltage Output Pin, connect a 0.1µF bypass capacitor and a high-value capacitor to GND, close to IC. (At least 10µF in USB applications.)
1, 5(KB)			
1(KE)			
2	1	GND	Ground pin of the circuitry
1(K)	5	FLG	Overcurrent and Overtemperature fault report; Open-Drain flag is active-low when triggered.
3(KA/KE)			
5(KC)			
3(K)	4	EN/ $\overline{\text{EN}}$	Enable input
1(KA)			AP22816A/17A/18A: Active-High
4(KB/KE)			AP22816B/17B/18B: Active-Low
4(K/KA)	2, 3	IN	Voltage Input Pin, connect a 1µF low ESR capacitor to GND, close to IC.
3(KB)			
5(KE)			

Functional Block Diagram

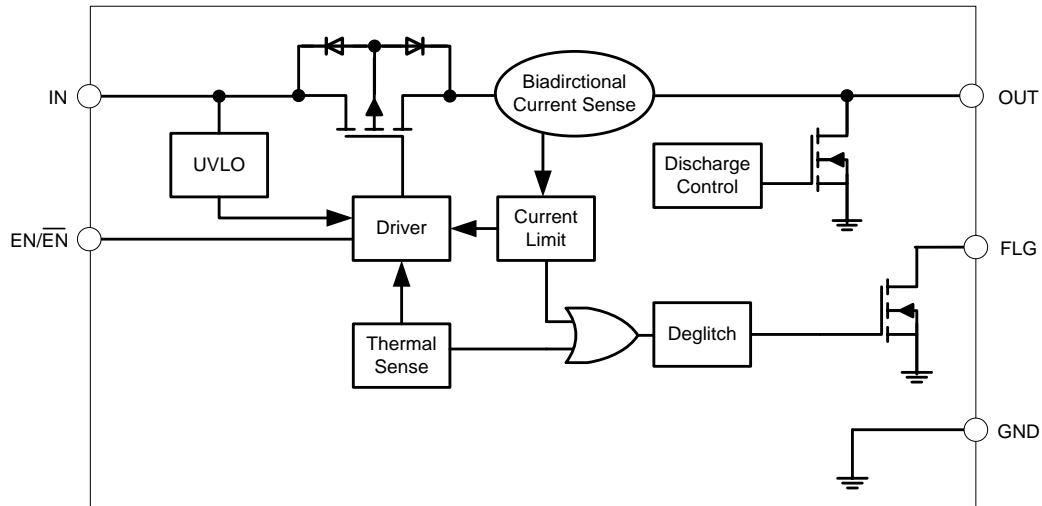

Absolute Maximum Ratings (@ $T_A = +25^\circ\text{C}$, unless otherwise specified.) (Note 4)

Symbol	Parameter		Ratings	Units
ESD	HBM	Human Body ESD Protection	2000	V
	CDM	Charged Device Model ESD Protection	500	V
	IEC System Level	Surges per IEC61000-4-2, 1999 Applied to Output Terminals of EVM (Note 6)	15	kV
V_{IN}	Input Voltage		-0.3 to 6.0	V
V_{OUT}	Output Voltage		-0.3 to ($V_{IN} + 0.3$)	V
$V_{EN/EN-}$	Enable Voltage		-0.3 to ($V_{IN} + 0.3$)	V
I_L	Load Current		Internal Limited	$^\circ\text{C}$
$T_{J(max)}$	Maximum Junction Temperature		+150	$^\circ\text{C}$
T_{ST}	Storage Temperature		-65 to +150	$^\circ\text{C}$
$R_{\theta JA}$	Thermal Resistance, Junction to Ambient	MSOP-8 (Note 5, 7)	165	$^\circ\text{C/W}$
	Thermal Resistance, Junction to Case	TSOT25 (Note 6, 7)	123	
$R_{\theta JC}$	Thermal Resistance, Junction to Case	MSOP-8 (Note 5, 7)	33	
		TSOT25 (Note 6, 7)	32	

- Notes:
- Stresses greater than the 'Absolute Maximum Ratings' specified above may cause permanent damage to the device. These are stress ratings only; functional operation of the device at these or any other conditions exceeding those indicated in this specification is not implied. Device reliability may be affected by exposure to absolute maximum rating conditions for extended periods of time.
 - External capacitors need to be connected to the output, EVM board was tested with external capacitor. This level is a pass test only and not a limit.
 - Test condition for TSOT25/MSOP-8: Device mounted on 1"x1"/2"x2" FR-4 substrate PC board, 2oz copper with minimum recommended pad layout.
 - $R_{\theta JA}$ and $R_{\theta JC}$ are measured at $T_A = 25^\circ\text{C}$ on a high effective thermal conductivity four-layer test board per JEDEC 51-7.

Recommended Operating Conditions (@ $T_A = +25^\circ\text{C}$, unless otherwise specified.) (Note 8)

Symbol	Parameter		Min	Max	Unit
V_{IN}	Input Voltage		2.7	5.5	V
I_{OUT}	Output Current	AP22816	0	1.0	A
		AP22817	0	1.5	
		AP22818	0	2.0	
V_{IL}	$\overline{EN/EN-}$ Input Logic Low Voltage		0	0.5	V
V_{IH}	$\overline{EN/EN-}$ Input Logic High Voltage		1.5	V_{IN}	V
T_A	Operating Ambient Temperature		-40	+85	$^\circ\text{C}$

- Note: 8. Refer to the typical application circuit.

Electrical Characteristics ($V_{IN} = 5V @ T_A = +25^{\circ}C, C_{IN} = 1\mu F, C_L = 100nF$, unless otherwise specified.)

Symbol	Parameter	Test Conditions	Min	Typ	Max	Unit
V_{UVLO}	Input UVLO	V_{IN} Rising	1.8	2.3	2.6	V
ΔV_{UVLO}	Input UVLO Hysteresis	V_{IN} Decreasing	—	180	—	mV
I_{SHDN}	Input Shutdown Current	Disabled, OUT = Open	—	0.1	1	μA
I_Q	Input Quiescent Current	Enabled, OUT = Open	—	80	—	μA
I_{LEAK}	Input Leakage Current	Disabled, OUT Grounded	—	0.1	1	μA
I_{REV}	Reverse Leakage Current	Disabled, $V_{IN} = 0V, V_{OUT} = 5V, I_{REV}$ at V_{IN}	—	0.01	1	μA
$R_{DS(ON)}$	Switch On-Resistance	$V_{IN} = 5V, I_{OUT} = 1A, T_A = +25^{\circ}C$	—	75	95	m Ω
I_{LIMIT}	Over Load Current Limit	$V_{IN} = 5V, V_{OUT} = 4.5V$ (AP22818)	2.2	2.7	3.2	A
		$V_{IN} = 5V, V_{OUT} = 4.5V$ (AP22817)	1.65	2.2	2.8	A
		$V_{IN} = 5V, V_{OUT} = 4.5V$ (AP22816)	1.1	1.5	2.1	A
I_{SHORT}	Short-Circuit Current Limit	Enabled, Output short to ground	—	0.5	—	A
V_{IL}	EN/ \overline{EN} Input Logic Low Voltage	$V_{IN} = 2.7V$ to $5.5V$	—	—	0.5	V
V_{IH}	EN/ \overline{EN} Input Logic High Voltage	$V_{IN} = 2.7V$ to $5.5V$	1.5	—	—	V
$I_{LEAK-EN/\overline{EN}}$	EN/ \overline{EN} Input Leakage	$V_{IN} = 5V, V_{EN/\overline{EN}} = 0V$ and $5.5V$	—	0.01	1	μA
I_{LEAK-O}	Output Leakage Current	Disabled, $V_{OUT} = 0V$	—	0.5	1	μA
$t_{D(ON)}$	Output Turn-On Delay Time	$C_L = 4.7\mu F, R_{LOAD} = 10\Omega @ V_{IN} = 3.3V$ Figure 1	—	1.5	—	ms
t_R	Output Turn-On Rise Time	$C_L = 4.7\mu F, R_{LOAD} = 10\Omega @ V_{IN} = 3.3V$ Figure 1	1.0	2.1	3.5	ms
$t_{D(OFF)}$	Output Turn-Off Delay Time	$C_L = 4.7\mu F, R_{LOAD} = 10\Omega @ V_{IN} = 3.3V$ Figure 1	—	20	—	μs
t_F	Output Turn-Off Fall Time	$C_L = 4.7\mu F, R_{LOAD} = 10\Omega @ V_{IN} = 3.3V$ Figure 1	—	0.15	—	ms
R_{FLG}	FLG Output FET On-Resistance	$I_{FLG} = 10mA$	—	30	60	Ω
I_{FOH}	FLG Off Current	$V_{FLG} = 5V$	—	0.01	1	μA
t_{BLANK}	FLG Blanking Time	Assertion or deassertion due to overcurrent and overtemperature condition	2	5	15	ms
t_{DIS}	Discharge Time	$C_L = 1\mu F, V_{IN} = 5V$, disabled to $V_{OUT} < 0.5V$	—	0.4	—	ms
R_{DIS}	Discharge Resistance	$V_{IN} = 5V$, Disabled, $I_{OUT} = 1mA$	—	140	200	Ω
T_{SHDN}	Thermal Shutdown Threshold	Enabled	—	+150	—	$^{\circ}C$
T_{HYS}	Thermal Shutdown Hysteresis	—	—	+40	—	$^{\circ}C$
V_{RVP}	Reverse-Voltage Comparator Trip Point	$V_{OUT} - V_{IN}$	35	70	105	mV
I_{ROCP}	Reverse Current Limit	$V_{OUT} - V_{IN} = 150mV$	—	350	—	mA
t_{TRIG}	Time from Reverse-Voltage Condition to MOSFET Turn off	V_{IN}	2	5	15	ms

Performance Characteristics

Figure 1. Voltage Waveforms: AP22816B (Active Low, Left), AP22816A (Active High, Right)

Performance Characteristics ($T_A = +25^\circ\text{C}$, $V_{IN} = 5\text{V}$, $C_{IN} = 1\mu\text{F}$, $C_L = 0.1\mu\text{F}$, unless otherwise specified.) (continued)

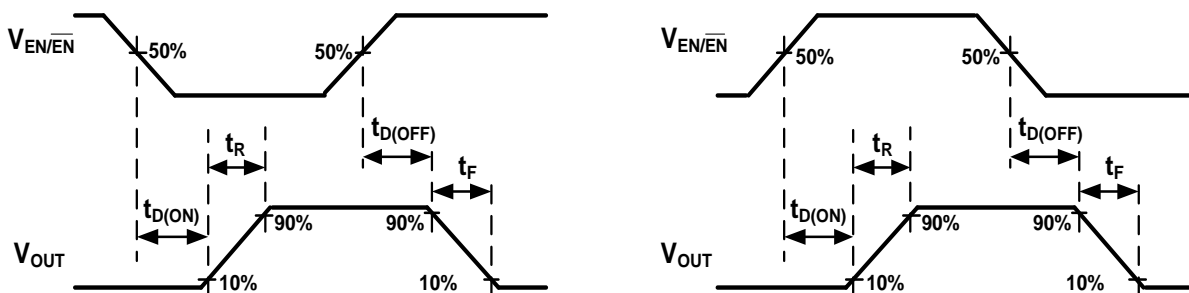
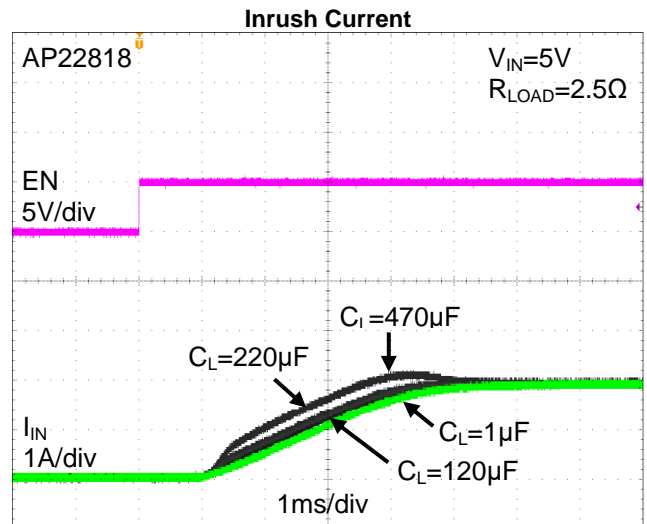
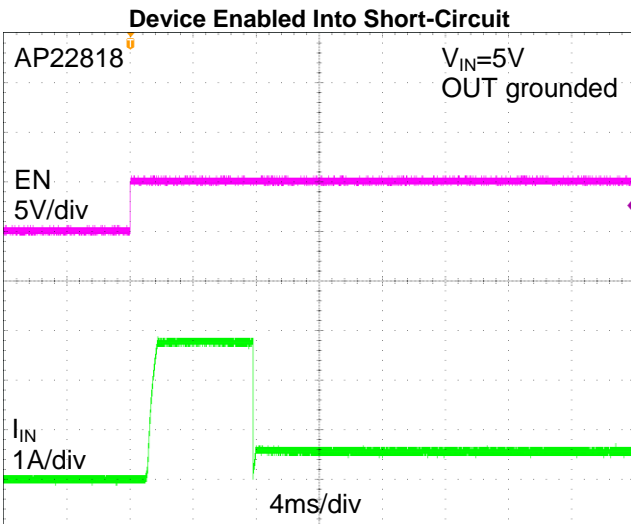
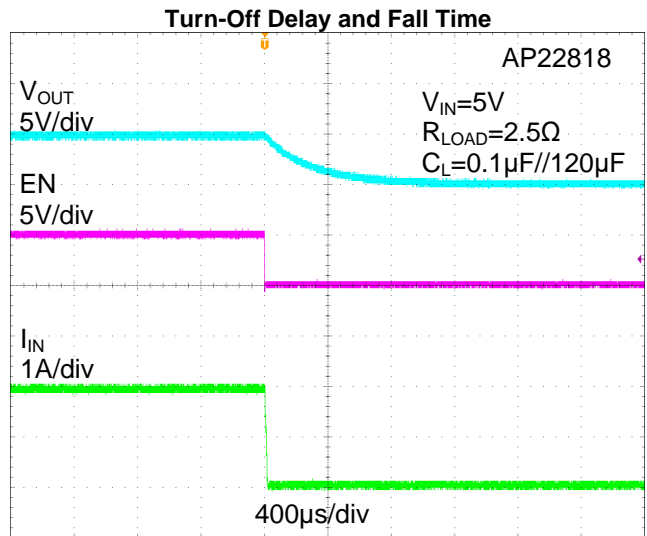
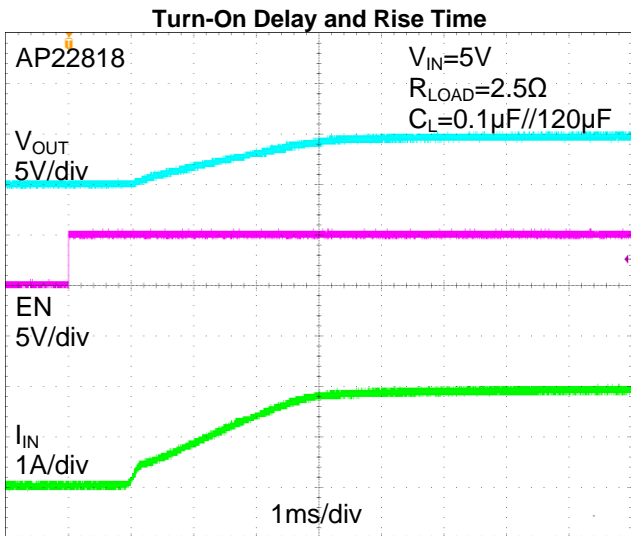
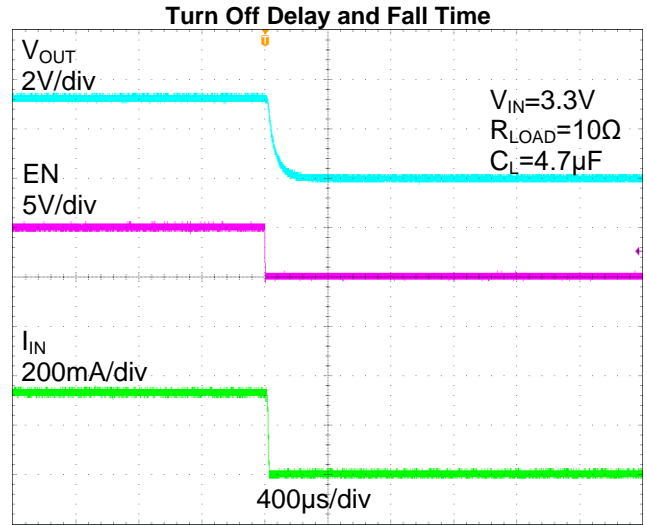
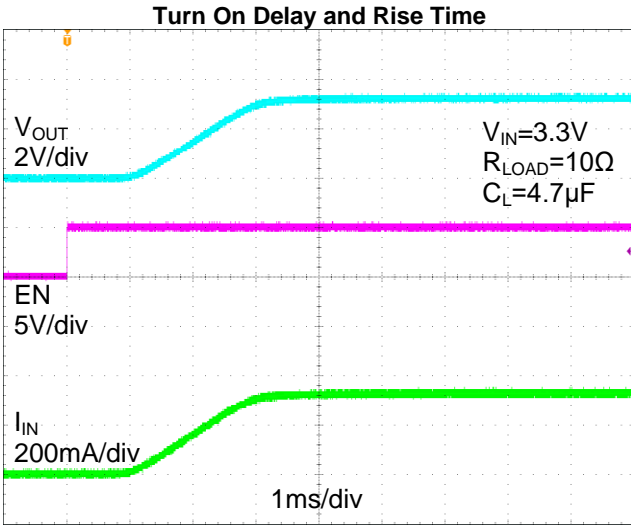

Performance Characteristics ($T_A = +25^\circ\text{C}$, $V_{IN} = 5\text{V}$, $C_{IN} = 1\mu\text{F}$, $C_L = 0.1\mu\text{F}$, unless otherwise specified.) (continued)

Full-Load to Short-Circuit Transient Response

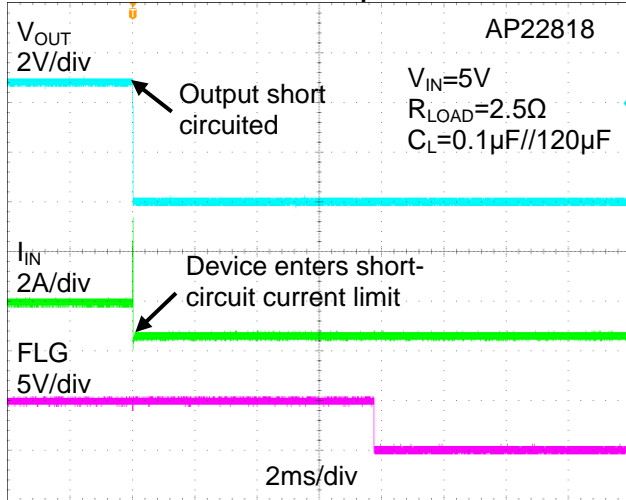

Short-Circuit to Full-Load Recovery Response

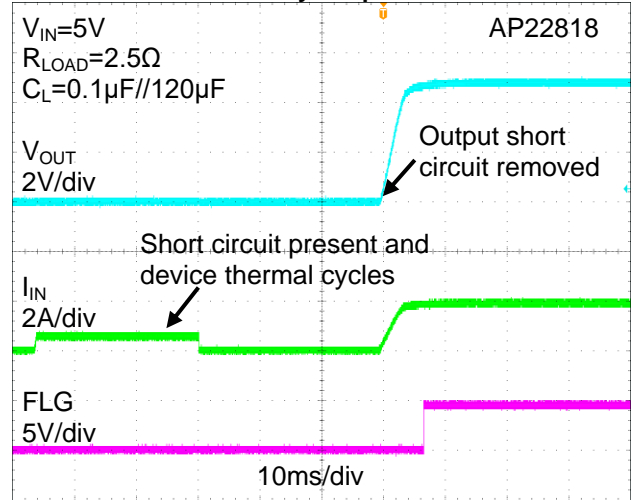

No-Load to Short-Circuit Transient Response

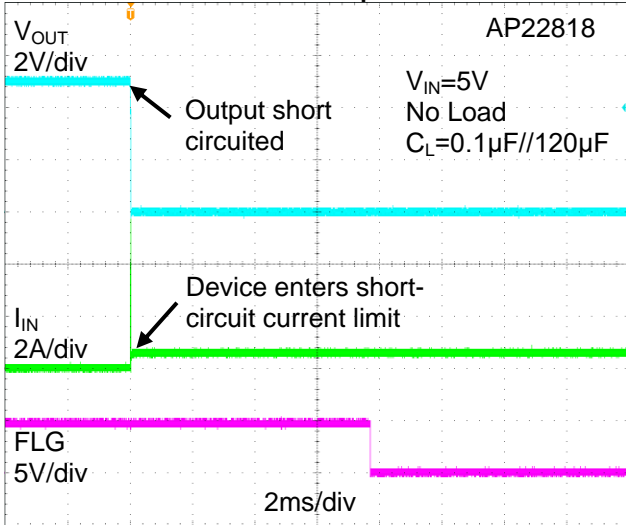

Short-Circuit to No-Load Recovery Response

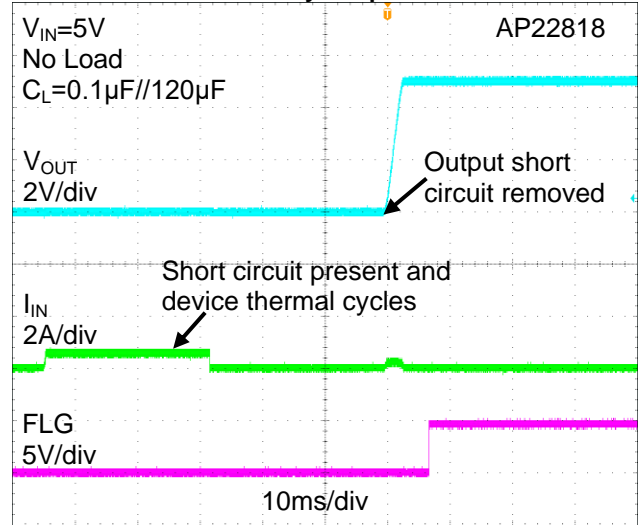

Power ON

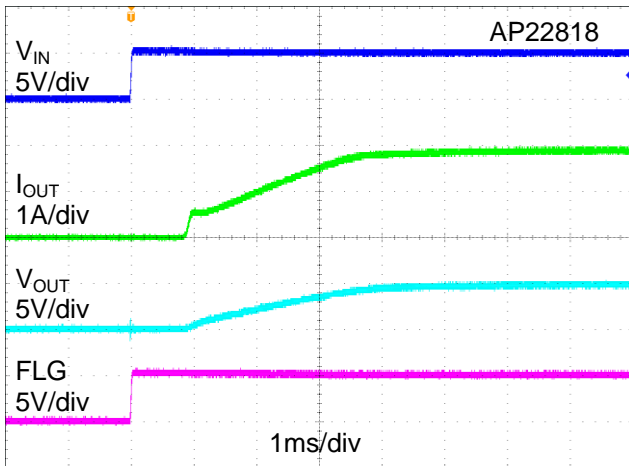

Short-Circuit with Blanking Time and Recovery

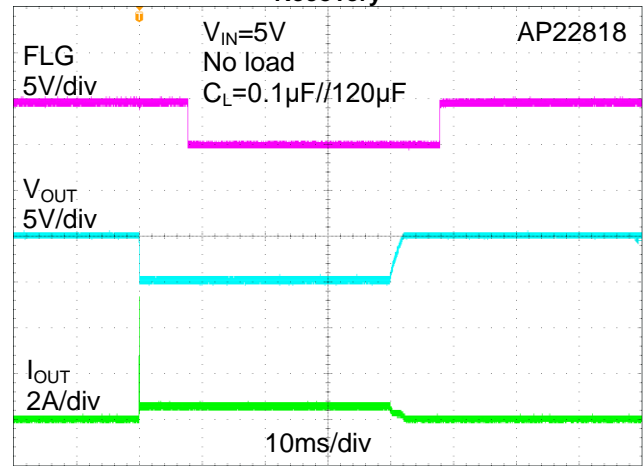

Performance Characteristics ($T_A = +25^\circ\text{C}$, $V_{IN} = 5\text{V}$, $C_{IN} = 1\mu\text{F}$, $C_L = 0.1\mu\text{F}$, unless otherwise specified.) (continued)

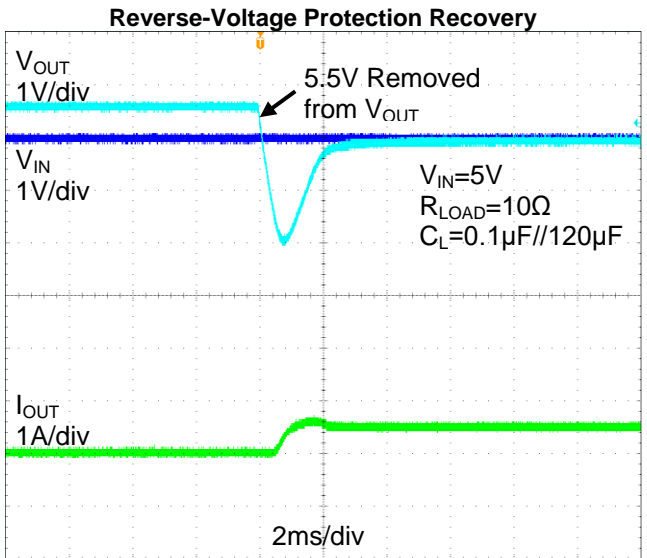
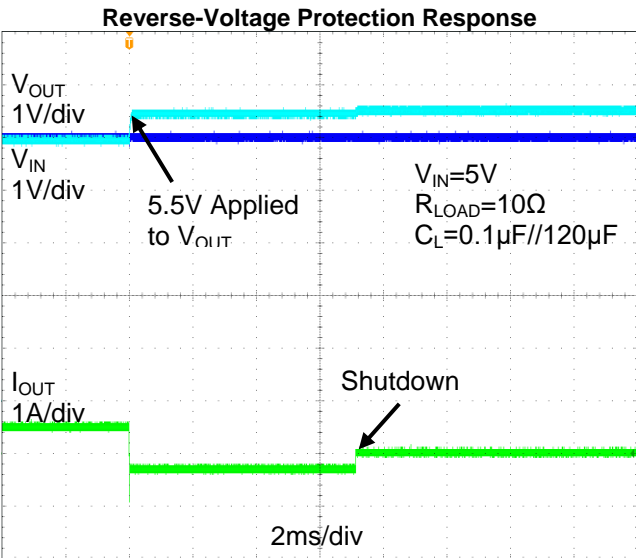
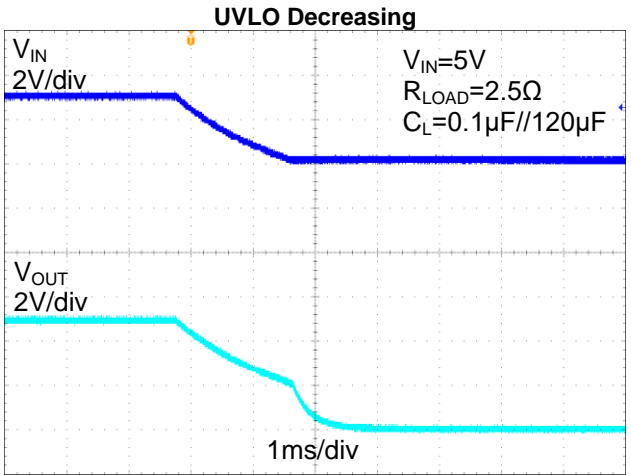
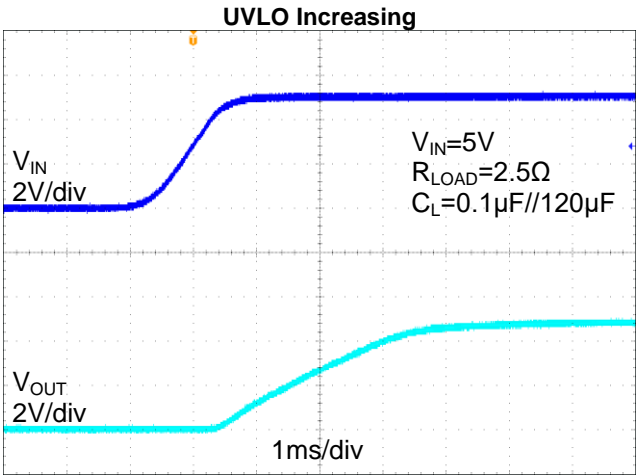

Performance Characteristics ($T_A = +25^\circ\text{C}$, $V_{IN} = 5\text{V}$, $C_{IN} = 1\mu\text{F}$, $C_L = 0.1\mu\text{F}$, unless otherwise specified.) (continued)

Turn-on Time vs. Input Voltage

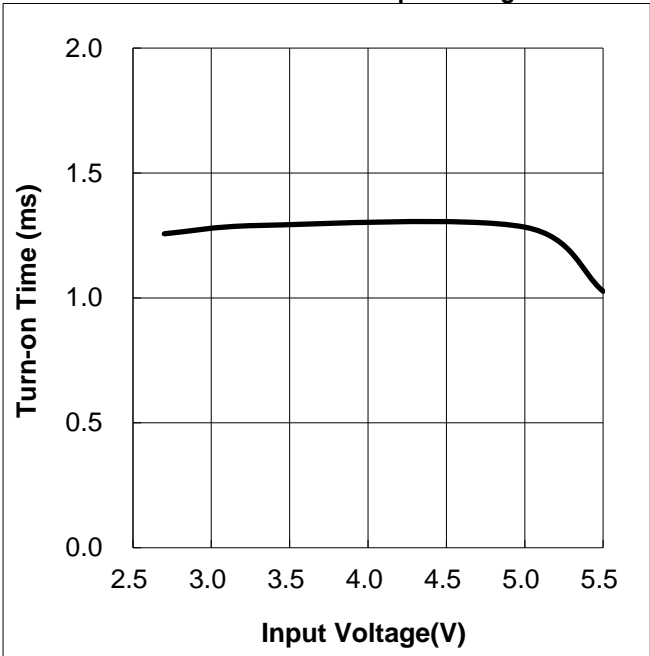

Turn-off Time vs. Input Voltage

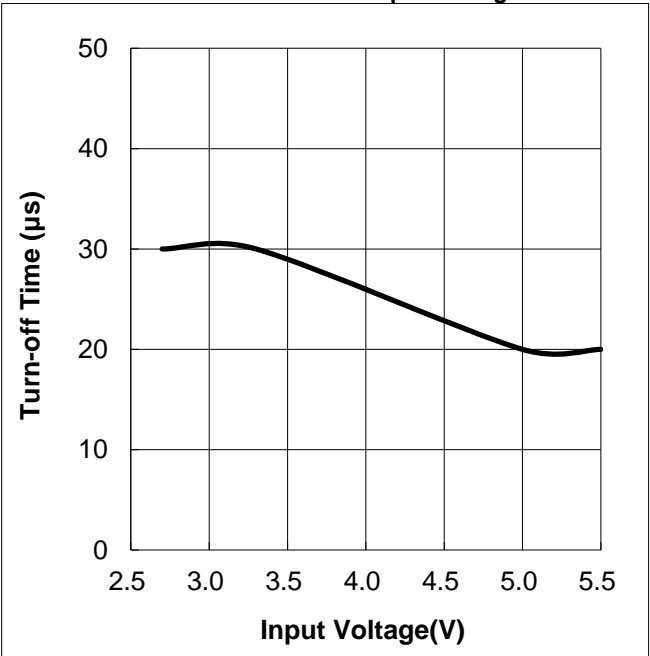

Rise Time vs. Input Voltage

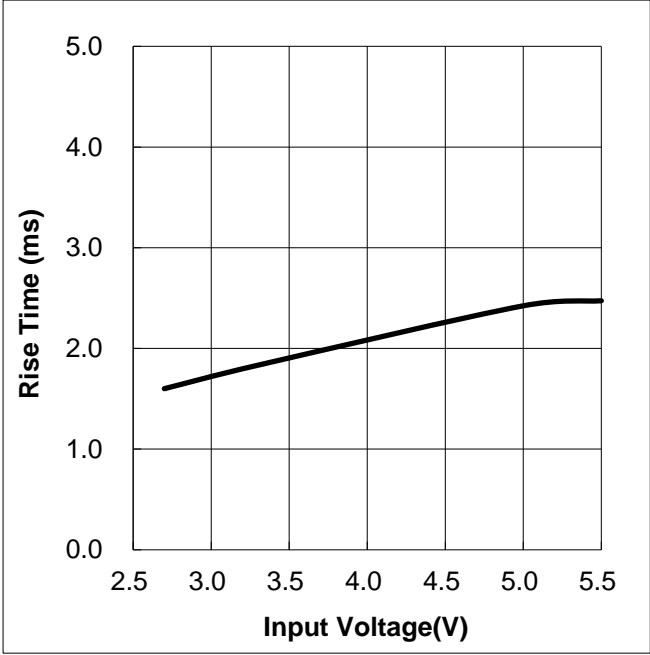

Fall Time vs. Input Voltage

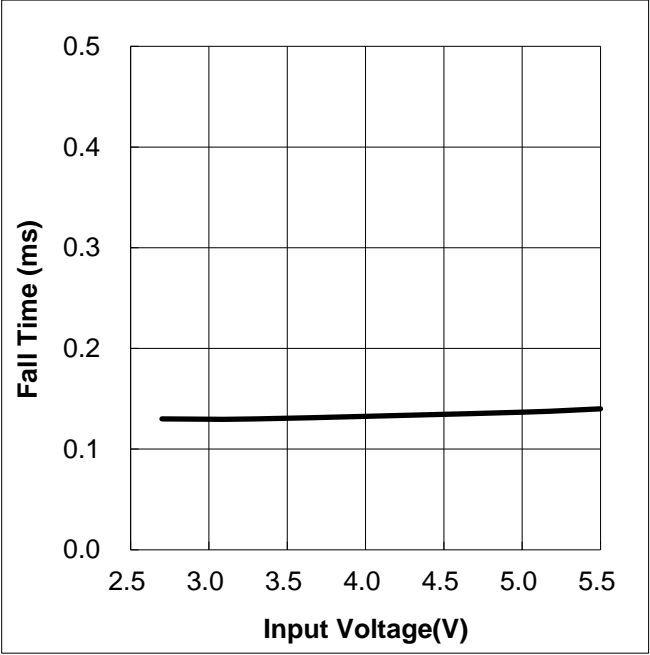

Performance Characteristics ($T_A = +25^\circ\text{C}$, $V_{IN} = 5\text{V}$, $C_{IN} = 1\mu\text{F}$, $C_L = 0.1\mu\text{F}$, unless otherwise specified.) (continued)

Supply Current vs. Temperature (Output Enabled)

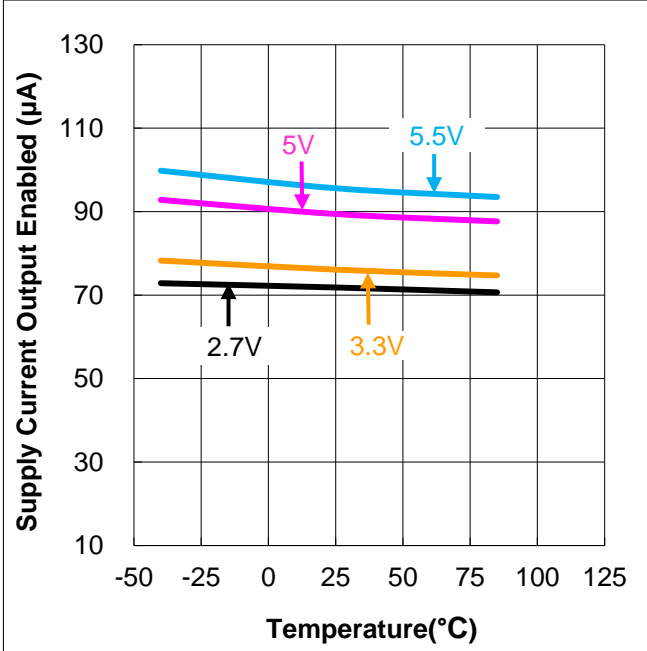

Supply Current vs. Temperature (Output Disabled)

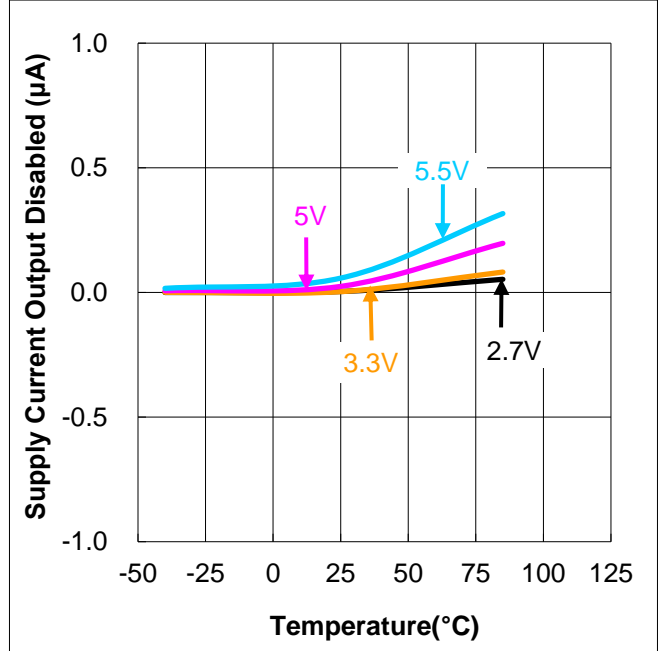

$R_{DS(ON)}$ vs. Temperature

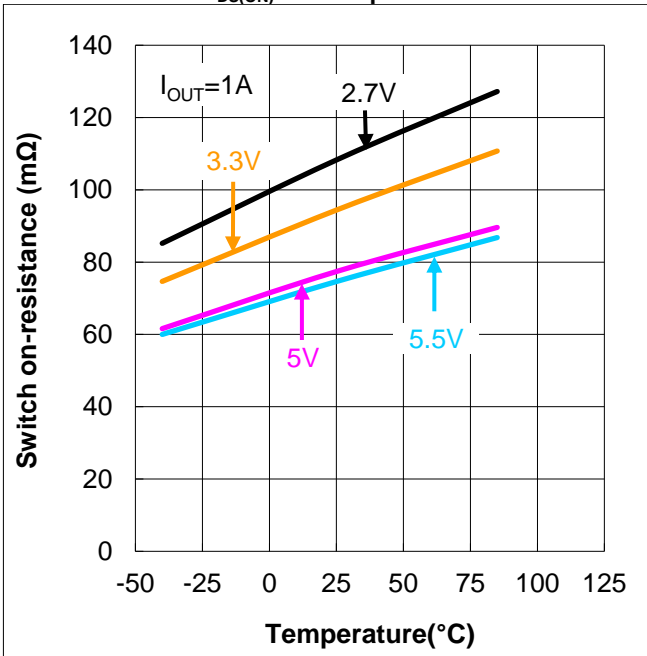

Short-Circuit Output Current vs. Temperature

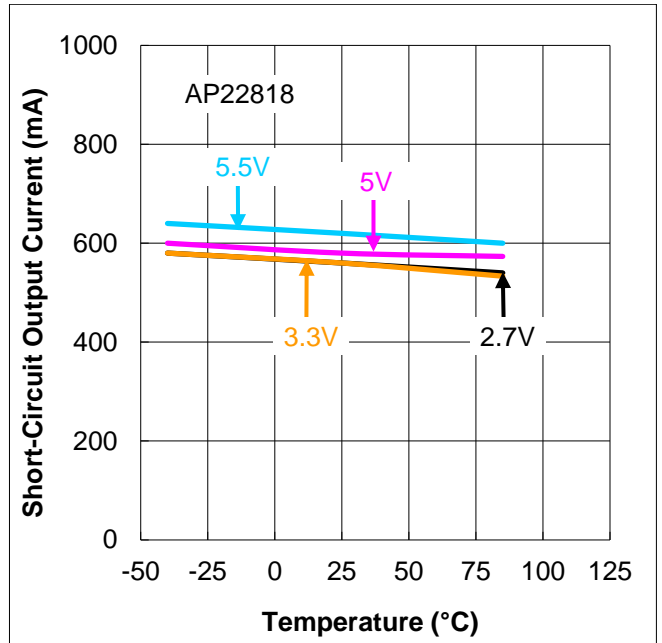

Performance Characteristics ($T_A = +25^\circ\text{C}$, $V_{IN} = 5\text{V}$, $C_{IN} = 1\mu\text{F}$, $C_L = 0.1\mu\text{F}$, unless otherwise specified.) (continued)

Under Voltage Lockout vs. Temperature

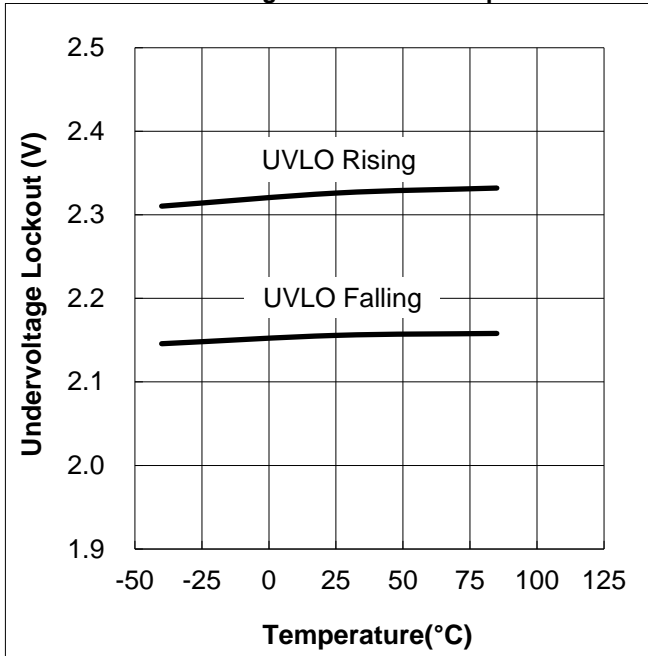

Over Load Current Limit vs. Temperature

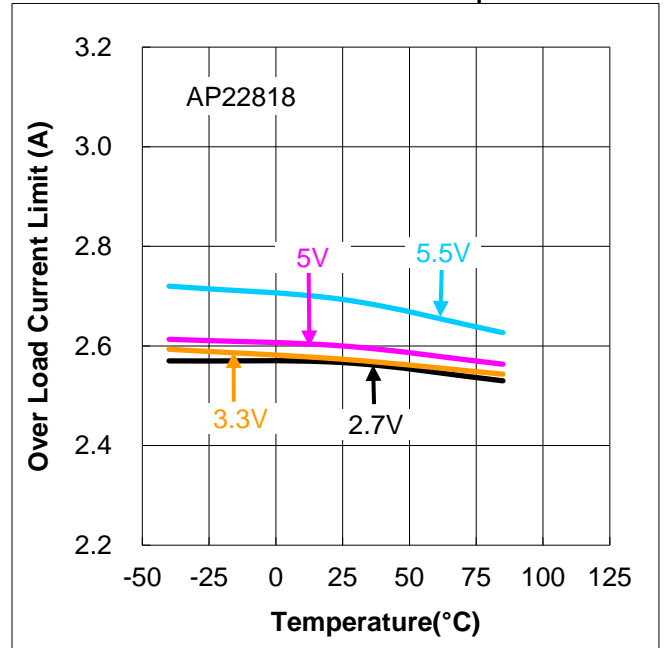

Reverse-Voltage Comparator Trip vs. Temperature

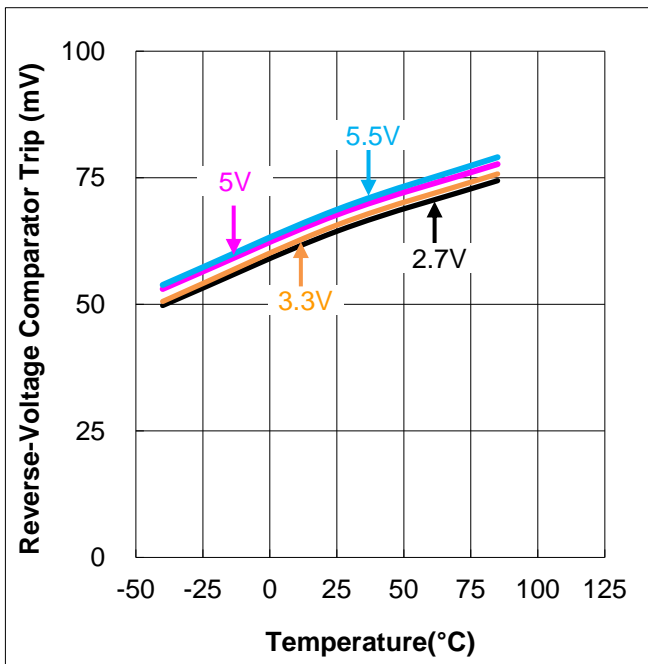

Reverse Current Limit vs. Temperature

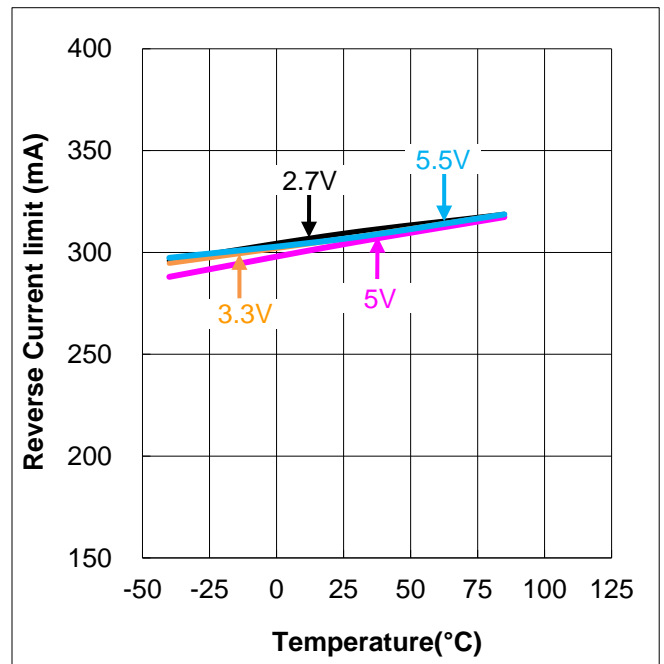

Application Information

Input and Output Capacitors

It is needed to place a 1 μ F X7R or X5R ceramic bypass capacitor between the IN and GND, close to the device. Placing a high-value capacitor (10 μ F or 47 μ F) close to the input pin is also recommended when the output transient load is heavy. This precaution reduces power-supply transients that may cause ringing on the input.

Also needed for hot-plug applications is the connection of a minimum 100 μ F low ESR electrolytic or tantalum capacitor (or 10 μ F MLCC) between OUT and GND is. It is necessary to bypass the output with a 0.1 μ F ceramic capacitor, which improves the immunity of the device to short-circuit transients. The Bulky 100 μ F or larger capacitors help to reduce output droop voltage when a device is plugged in. When abnormal short-circuit condition happens, these capacitors can also reduce output negative voltage due to parasitic inductive effect and avoid device damage.

Please note that without the bypass capacitors, an output short may cause ringing on the input; if the voltage is over the maximum voltage rating, it will destroy the internal control circuitry even if the duration is short.

FLG Response

When an overcurrent or overtemperature shutdown condition is encountered, the FLG open-drain output goes active low after a nominal 6ms deglitch timeout. The FLG output remains low until both overcurrent and overtemperature conditions are removed. Connecting a heavy capacitive load to the output of the device can cause a momentary overcurrent condition, which does not trigger the FLG due to the 6ms deglitch timeout. The AP22816(1.0A)/17(1.5A)/18(2.0A) is designed to eliminate false overcurrent reporting without the need of external components to remove unwanted pulses.

Overcurrent and Short Circuit Protection

An internal sensing FET is employed to check for overcurrent conditions. Unlike current-sense resistors, sense FETs do not increase the series resistance of the current path. When an overcurrent condition is detected, the device maintains a constant output current and reduces the output voltage accordingly. Complete shutdown occurs only if the fault stays long enough to activate thermal limiting.

Three possible overload conditions can occur. In the first condition, the output has been shorted to GND before the device is enabled or before V_{IN} has been applied. The AP22816(1.0A)/17(1.5A)/18(2.0A) senses the short circuit and immediately clamps output current to a certain safe level.

In the second condition, an output short or an overload occurs while the device is enabled. At the instance the overload occurs, higher current may flow for a very short period of time before the current limit function can react. After the current limit function has tripped, the device switches into current limiting mode and the current is clamped at I_{LIMIT} , or I_{SHORT} .

In the third condition, the load has been gradually increased beyond the recommended operating current. The current is permitted to rise until the current-limit threshold (I_{TRIG}) is reached or until the thermal limit of the device is exceeded. The AP22816(1.0A)/17(1.5A)/18(2.0A) is capable of delivering current up to the current-limit threshold without damaging the device. Once the threshold has been reached, the device switches into its current limiting mode and is set at I_{LIMIT} .

Thermal Protection

Thermal protection prevents the IC from damage when heavy-overload or short-circuit faults are present for extended periods of time. The AP22816(1.0A)/17(1.5A)/18(2.0A) implements a thermal sensing to monitor the operating junction temperature of the power distribution switch. Once the die temperature rises to approximately +140°C due to excessive power dissipation in an overcurrent or short-circuit condition, the internal thermal sense circuitry turns the power switch off, thus preventing the power switch from damage. Hysteresis is built into the thermal sense circuit allowing the device to cool down approximately +35°C before the switch turns back on. The switch continues to cycle in this manner until the load fault or input power is removed. The FLG open-drain output is asserted when an overtemperature shutdown or overcurrent occurs with 6ms deglitch.

ON/OFF Input Operator

The $\overline{EN/EN}$ input allows the output current to be switched on and off using a GPIO compatible input. The high signal (switched on) should be at least 1.5V, and the low signal (switch off) no higher than 0.65V. This pin should not be left floating. It is advisable to hold the $\overline{EN/EN}$ signal low when applying or removing power.

Application Information (continued)

Undervoltage Lockout (UVLO)

Undervoltage lockout function (UVLO) keeps the internal power switch from being turned on until the power supply has reached at least 2V, even if the switch is enabled. Whenever the input voltage falls below approximately 2V, the power switch is quickly turned off. This facilitates the design of hot-insertion systems where it is not possible to turn off the power switch before input power is removed.

Discharge Function

The discharge function of the device is active when the enable is disabled or de-asserted. The discharge function with the N-MOS power switch implementation is activated and offers a resistive discharge path for the external storage capacitor. This is designed for discharging any residue of the output voltage when either no external output resistance or load resistance is present at the output.

Output Reverse-Voltage/Current Protection

The output reverse-voltage protection turns off the MOSFET switch whenever the output voltage is higher than the input voltage by 50mV for 6ms. The MOSFET switch will turn on when output reverse-voltage/current conditions are removed.

Power Dissipation and Junction Temperature

The low on-resistance of the internal MOSFET allows the small surface-mount packages to pass large currents. Using the maximum operating ambient temperature (T_A) and $R_{DS(ON)}$, the power dissipation can be calculated by:

$$P_D = R_{DS(ON)} \times I^2$$

Finally, calculate the junction temperature:

$$T_J = P_D \times R_{\theta JA} + T_A$$

Where:

T_A = Ambient temperature °C

$R_{\theta JA}$ = Thermal resistance

P_D = Total power dissipation

Board Layout Instruction

To minimize the effects of parasitic inductance, place input and output capacitors (1 μ F and 0.1 μ F+100 μ F respectively) close and next to the device's pins. For the best performance, all trace lengths should be kept as short as possible and the input and output PCB traces should be as wide as possible. Use a ground plane to enhance the power dissipation capability of the device. For TOS25 Type KB and MSOP-8, it is recommended to connect all IN pins together and all OUT pins together to improve overall resistance value.

Ordering Information

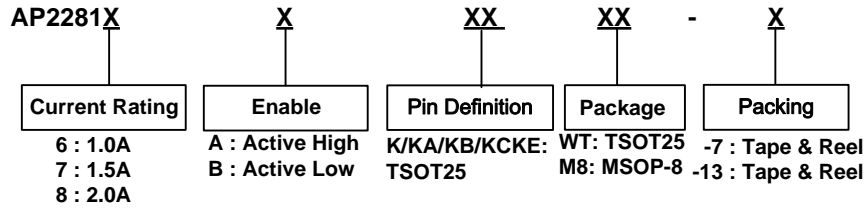

Part Number	Package Code	Package	7" and 13" Tape and Reel	
			Quantity	Part Number Suffix
AP22816AKWT-7	WT	TSOT25	3000/Tape & Reel	-7
AP22816BKWT-7	WT	TSOT25	3000/Tape & Reel	-7
AP22816AKAWT-7	WT	TSOT25	3000/Tape & Reel	-7
AP22816BKAWT-7	WT	TSOT25	3000/Tape & Reel	-7
AP22816AKBWT-7	WT	TSOT25	3000/Tape & Reel	-7
AP22816BKBWT-7	WT	TSOT25	3000/Tape & Reel	-7
AP22816AKCWT-7	WT	TSOT25	3000/Tape & Reel	-7
AP22816BKCWT-7	WT	TSOT25	3000/Tape & Reel	-7
AP22816AKEWT-7	WT	TSOT25	3000/Tape & Reel	-7
AP22816BKEWT-7	WT	TSOT25	3000/Tape & Reel	-7
AP22817AKAWT-7	WT	TSOT25	3000/Tape & Reel	-7
AP22817BKAWT-7	WT	TSOT25	3000/Tape & Reel	-7
AP22817AKBWT-7	WT	TSOT25	3000/Tape & Reel	-7
AP22817BKBWT-7	WT	TSOT25	3000/Tape & Reel	-7
AP22817AKCWT-7	WT	TSOT25	3000/Tape & Reel	-7
AP22817BKCWT-7	WT	TSOT25	3000/Tape & Reel	-7
AP22817AKEWT-7	WT	TSOT25	3000/Tape & Reel	-7
AP22817BKEWT-7	WT	TSOT25	3000/Tape & Reel	-7
AP22818AKWT-7	WT	TSOT25	3000/Tape & Reel	-7
AP22818BKWT-7	WT	TSOT25	3000/Tape & Reel	-7
AP22818AKAWT-7	WT	TSOT25	3000/Tape & Reel	-7
AP22818BKAWT-7	WT	TSOT25	3000/Tape & Reel	-7
AP22818AKBWT-7	WT	TSOT25	3000/Tape & Reel	-7
AP22818BKBWT-7	WT	TSOT25	3000/Tape & Reel	-7
AP22818AKCWT-7	WT	TSOT25	3000/Tape & Reel	-7
AP22818BKCWT-7	WT	TSOT25	3000/Tape & Reel	-7
AP22818AKEWT-7	WT	TSOT25	3000/Tape & Reel	-7
AP22818BKEWT-7	WT	TSOT25	3000/Tape & Reel	-7
AP22818AM8-13	M8	MSOP-8	2500/Tape & Reel	-13
AP22818BM8-13	M8	MSOP-8	2500/Tape & Reel	-13

Marking Information

(1) TSOT25

(Top View)

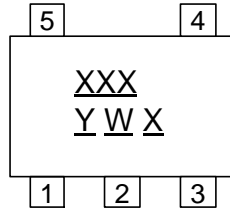

XXX : Identification Code
 Y : Year 0 to 9
 W : Week : A to Z : 1 to 26 week;
 a to z : 27 to 52 week; z represents 52 and 53 week
 X : Internal Code

Part Number	Package	Identification Code
AP22816AKWT-7	TSOT25	F2A
AP22816BKWT-7	TSOT25	F2B
AP22816AKAWT-7	TSOT25	F2C
AP22816BKAWT-7	TSOT25	F2D
AP22816AKBWT-7	TSOT25	F2E
AP22816BKBWT-7	TSOT25	F2F
AP22816AKCWT-7	TSOT25	F2G
AP22816BKCWT-7	TSOT25	F2H
AP22816AKEWT-7	TSOT25	F2J
AP22816BKEWT-7	TSOT25	F2K
AP22817AKAWT-7	TSOT25	F2M
AP22817BKAWT-7	TSOT25	F2N
AP22817AKBWT-7	TSOT25	F2P
AP22817BKBWT-7	TSOT25	F2R
AP22817AKCWT-7	TSOT25	F2S
AP22817BKCWT-7	TSOT25	F2T
AP22817AKEWT-7	TSOT25	F2U
AP22817BKEWT-7	TSOT25	F2V
AP22818AKWT-7	TSOT25	F2W
AP22818BKWT-7	TSOT25	F2X
AP22818AKAWT-7	TSOT25	F2Y
AP22818BKAWT-7	TSOT25	F2Z
AP22818AKBWT-7	TSOT25	F22
AP22818BKBWT-7	TSOT25	F23
AP22818AKCWT-7	TSOT25	F24
AP22818BKCWT-7	TSOT25	F25
AP22818AKEWT-7	TSOT25	F26
AP22818BKEWT-7	TSOT25	F27

(2) MSOP-8

(Top View)

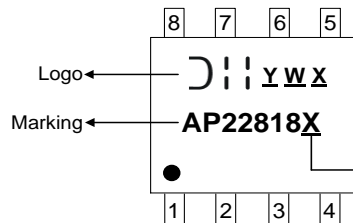

Y : Year : 0~9
 W : Week : A~Z : 1~26 week;
 a~z : 27~52 week; z represents 52 and 53 week
 X : Internal Code
 A : Active High
 B : Active Low

Part Number	Package	Identification Code
AP22818AM8-13	MSOP-8	AP22818A
AP22818BM8-13	MSOP-8	AP22818B

Package Outline Dimensions

Please see <http://www.diodes.com/package-outlines.html> for the latest version.

TSOT25

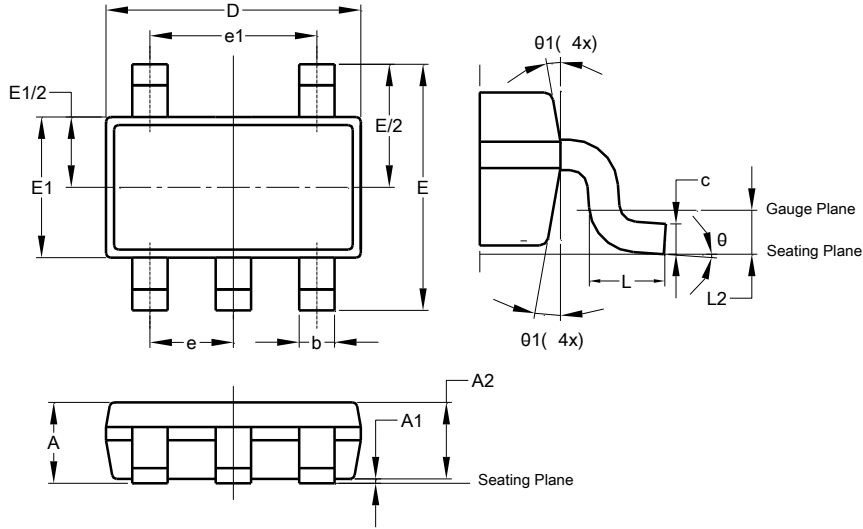

TSOT25			
Dim	Min	Max	Typ
A	-	1.00	-
A1	0.01	0.10	-
A2	0.84	0.90	-
b	0.30	0.45	-
c	0.12	0.20	-
D	2.80	3.00	2.90
E	2.70	2.90	2.80
E1	1.50	1.70	1.60
e	0.95 BSC		
e1	1.90 BSC		
L	0.30	0.50	
L2	0.25 BSC		
theta	0°	8°	4°
theta1	4°	12°	-
All Dimensions in mm			

MSOP-8

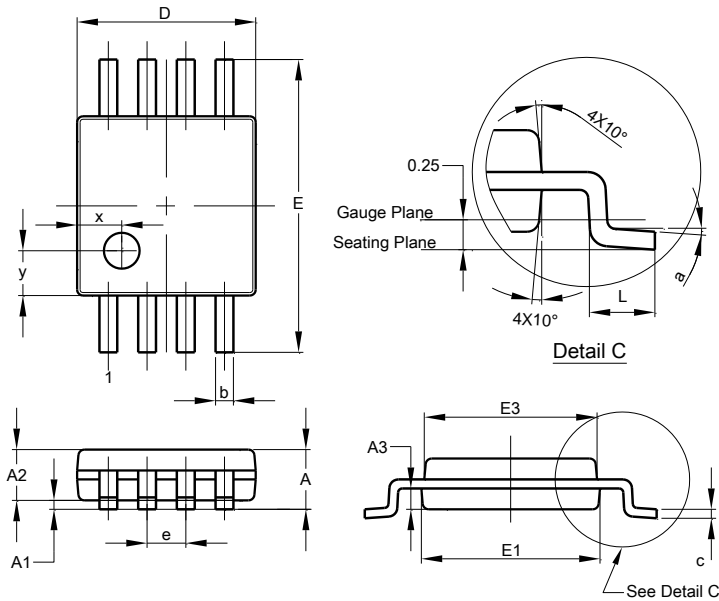

MSOP-8			
Dim	Min	Max	Typ
A	-	1.10	-
A1	0.05	0.15	0.10
A2	0.75	0.95	0.86
A3	0.29	0.49	0.39
b	0.22	0.38	0.30
c	0.08	0.23	0.15
D	2.90	3.10	3.00
E	4.70	5.10	4.90
E1	2.90	3.10	3.00
E3	2.85	3.05	2.95
e	-	-	0.65
L	0.40	0.80	0.60
a	0°	8°	4°
x	-	-	0.750
y	-	-	0.750
All Dimensions in mm			

Suggested Pad Layout

Please see <http://www.diodes.com/package-outlines.html> for the latest version.

TSOT25

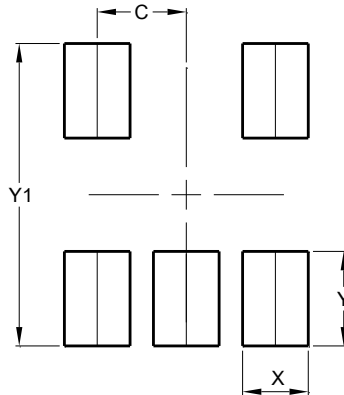

Dimensions	Value (in mm)
C	0.950
X	0.700
Y	1.000
Y1	3.199

MSOP-8

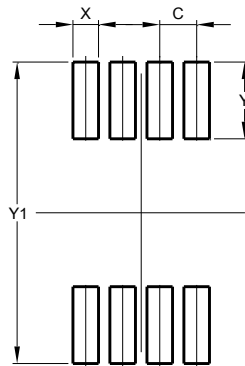

Dimensions	Value (in mm)
C	0.650
X	0.450
Y	1.350
Y1	5.300

IMPORTANT NOTICE

1. DIODES INCORPORATED (Diodes) AND ITS SUBSIDIARIES MAKE NO WARRANTY OF ANY KIND, EXPRESS OR IMPLIED, WITH REGARDS TO ANY INFORMATION CONTAINED IN THIS DOCUMENT, INCLUDING, BUT NOT LIMITED TO, THE IMPLIED WARRANTIES OF MERCHANTABILITY, FITNESS FOR A PARTICULAR PURPOSE OR NON-INFRINGEMENT OF THIRD PARTY INTELLECTUAL PROPERTY RIGHTS (AND THEIR EQUIVALENTS UNDER THE LAWS OF ANY JURISDICTION).
2. The Information contained herein is for informational purpose only and is provided only to illustrate the operation of Diodes' products described herein and application examples. Diodes does not assume any liability arising out of the application or use of this document or any product described herein. This document is intended for skilled and technically trained engineering customers and users who design with Diodes' products. Diodes' products may be used to facilitate safety-related applications; however, in all instances customers and users are responsible for (a) selecting the appropriate Diodes products for their applications, (b) evaluating the suitability of Diodes' products for their intended applications, (c) ensuring their applications, which incorporate Diodes' products, comply the applicable legal and regulatory requirements as well as safety and functional-safety related standards, and (d) ensuring they design with appropriate safeguards (including testing, validation, quality control techniques, redundancy, malfunction prevention, and appropriate treatment for aging degradation) to minimize the risks associated with their applications.
3. Diodes assumes no liability for any application-related information, support, assistance or feedback that may be provided by Diodes from time to time. Any customer or user of this document or products described herein will assume all risks and liabilities associated with such use, and will hold Diodes and all companies whose products are represented herein or on Diodes' websites, harmless against all damages and liabilities.
4. Products described herein may be covered by one or more United States, international or foreign patents and pending patent applications. Product names and markings noted herein may also be covered by one or more United States, international or foreign trademarks and trademark applications. Diodes does not convey any license under any of its intellectual property rights or the rights of any third parties (including third parties whose products and services may be described in this document or on Diodes' website) under this document.
5. Diodes' products are provided subject to Diodes' Standard Terms and Conditions of Sale (<https://www.diodes.com/about/company/terms-and-conditions/terms-and-conditions-of-sales/>) or other applicable terms. This document does not alter or expand the applicable warranties provided by Diodes. Diodes does not warrant or accept any liability whatsoever in respect of any products purchased through unauthorized sales channel.
6. Diodes' products and technology may not be used for or incorporated into any products or systems whose manufacture, use or sale is prohibited under any applicable laws and regulations. Should customers or users use Diodes' products in contravention of any applicable laws or regulations, or for any unintended or unauthorized application, customers and users will (a) be solely responsible for any damages, losses or penalties arising in connection therewith or as a result thereof, and (b) indemnify and hold Diodes and its representatives and agents harmless against any and all claims, damages, expenses, and attorney fees arising out of, directly or indirectly, any claim relating to any noncompliance with the applicable laws and regulations, as well as any unintended or unauthorized application.
7. While efforts have been made to ensure the information contained in this document is accurate, complete and current, it may contain technical inaccuracies, omissions and typographical errors. Diodes does not warrant that information contained in this document is error-free and Diodes is under no obligation to update or otherwise correct this information. Notwithstanding the foregoing, Diodes reserves the right to make modifications, enhancements, improvements, corrections or other changes without further notice to this document and any product described herein. This document is written in English but may be translated into multiple languages for reference. Only the English version of this document is the final and determinative format released by Diodes.
8. Any unauthorized copying, modification, distribution, transmission, display or other use of this document (or any portion hereof) is prohibited. Diodes assumes no responsibility for any losses incurred by the customers or users or any third parties arising from any such unauthorized use.
9. This Notice may be periodically updated with the most recent version available at <https://www.diodes.com/about/company/terms-and-conditions/important-notice>

DIODES is a trademark of Diodes Incorporated in the United States and other countries.
The Diodes logo is a registered trademark of Diodes Incorporated in the United States and other countries.
© 2022 Diodes Incorporated. All Rights Reserved.

www.diodes.com

Looking for pricing, stock, or lifecycle information?

Click below to explore more details on WIN SOURCE:

 [View AP22818AKAWT-7 on WIN SOURCE](#)

 [Diodes Incorporated Information](#)

Optimize Your Supply Chain with WIN SOURCE Solutions

-  Global Sourcing Solution
-  Obsolete Management
-  Cost Control Management
-  Shortage Management
-  Alternative Solution
-  Excess Inventory Management