

Electrical Characteristics

Part Number	Inductance (nH)	Tolerance (±%)	Test Frequency (MHz)	Q Typ.	SRF (MHz)Min.	RDC (Ω)Max.	Irms (mA)Typ.
BWLS000604042N2□00	2.2	10	100	5	3000	0.09	1600
BWLS000604046N8□00	6.8	10 / 5	100	6	2400	0.11	950
BWLS000604047N8□00	7.8	10 / 5	100	7	2500	0.11	1050
BWLS0006040415N□00	15	10 / 5	100	7	2300	0.12	750
BWLS0006040417N□00	17	10 / 5	100	7	2400	0.13	750
BWLS0006040426N□00	26	10 / 5	100	7	2200	0.20	750
BWLS0006040428N□00	28	10 / 5	100	7	2400	0.2.	700
BWLS0006040439N□00	39	10 / 5	100	7	2300	0.24	580
BWLS0006040443N□00	43	10 / 5	100	7	2200	0.24	600
BWLS0006040456N□00	56	10 / 5	100	7	2200	0.26	550
BWLS0006040459N□00	59	10 / 5	100	7	2200	0.26	500
BWLS0006040476N□00	76	10 / 5	100	7	2000	0.30	500
BWLS0006040478N□00	78	10 / 5	100	7	2000	0.30	500
BWLS00060404R10□00	100	10 / 5	100	7	1500	0.41	430
BWLS00060404R13□00	130	10 / 5	100	7	1500	0.44	400
BWLS00060404R16□00	160	10 / 5	100	7	1400	0.71	350
BWLS00060404R20□00	200	10 / 5	50	9	1400	0.95	260

Note: When ordering, please specify tolerance code. Tolerance : J=±5% , K=±10%

- Operating temperature range - 25°C ~ 105°C(Including self - temperature rise)
- I_{rms} for a 15°C temperature rise from 25°C ambient with current
- Measure Equipment :
 L & Q : Agilent E4991A+Agilent HP16197A
 SRF : Agilent E4991A
 RDC : HP4287
 I_{rms} : HP4284A+HP42841A

Test Instruments : Agilent E4991A Material/Impedance Analyzer

Typical L vs. Frequency

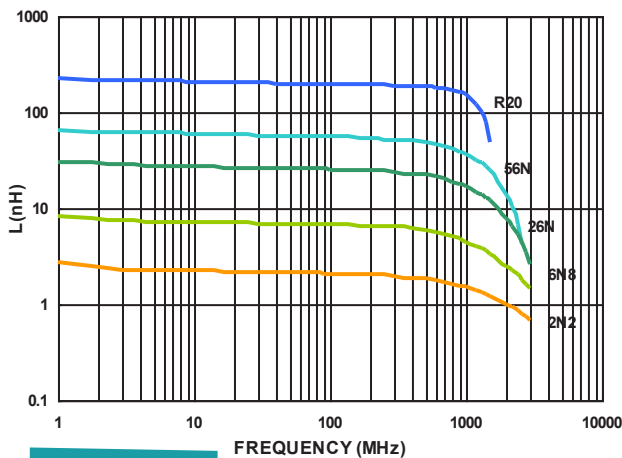

Typical Q vs. Frequency

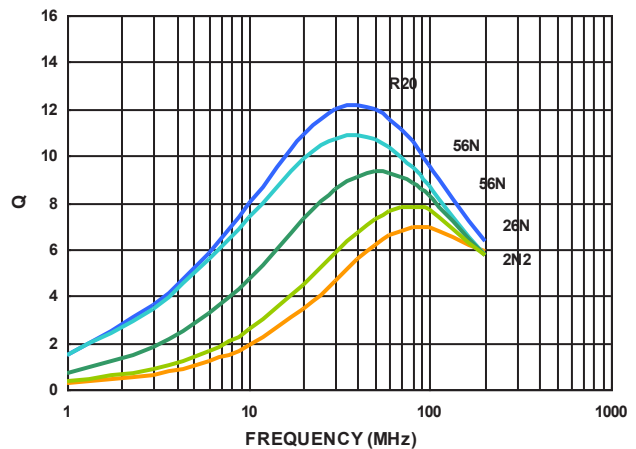

Electrical Characteristics

Part Number	Inductance (μ H)	Tolerance (\pm %)	Test Frequency (MHz)	Q Typ.	SRF (MHz)Typ.	RDC (Ω) Max	Irms (mA)Typ.
BWLS0010060618N□00	0.018	10 / 5	100	10	2600	0.055	1600
BWLS0010060620N□00	0.020	10 / 5	100	10	2600	0.050	1600
BWLS0010060622N□00	0.022	10	100	10	2500	0.072	1300
BWLS0010060633N□00	0.033	10 / 5	100	10	2300	0.060	1400
BWLS0010060636N□00	0.036	10 / 5	100	10	2300	0.092	1000
BWLS0010060639N□00	0.039	10 / 5	100	10	2200	0.150	830
BWLS0010060651N□00	0.051	10	100	10	1930	0.070	1100
BWLS0010060656N□00	0.056	10	100	10	1900	0.125	900
BWLS0010060672N□00	0.072	10 / 5	100	10	1650	0.100	900
BWLS0010060678N□00	0.078	10 / 5	100	10	1600	0.190	850
BWLS00100606R10□00	0.10	10	100	9	1400	0.160	900
BWLS00100606R14□00	0.14	10 / 5	50	11	1220	0.260	540
BWLS00100606R18□00	0.18	10	50	11	1150	0.330	560
BWLS00100606R20□00	0.20	10 / 5	50	11	1000	0.440	400
BWLS00100606R22□00	0.22	10 / 5	50	11	1150	0.530	380
BWLS00100606R25□00	0.25	10 / 5	25	11	900	0.360	520
BWLS00100606R27□00	0.27	10	25	11	860	0.550	360
BWLS00100606R30□00	0.30	10 / 5	25	11	860	0.410	420
BWLS00100606R33□00	0.33	10 / 5	7.9	11	820	0.680	350
BWLS00100606R36□00	0.36	10 / 5	7.9	11	810	0.575	360
BWLS00100606R39□00	0.39	10 / 5	7.9	11	760	0.890	300
BWLS00100606R42□00	0.42	10 / 5	7.9	11	700	1.100	340
BWLS00100606R47□00	0.47	10	7.9	11	650	0.730	310
BWLS00100606R56□00	0.56	10 / 5	7.9	11	600	1.100	200

Note: When ordering, please specify tolerance code. Tolerance : J=±5% , K=±10%

- Operating temperature range - 25°C ~ 105°C(Including self - temperature rise)
- Irms for a 15°C temperature rise from 25°C ambient with current
- Measure Equipment :
 L & Q : Agilent E4991A+Agilent HP16197A
 SRF : Agilent E4991A
 RDC : Chroma 16502
 Irms : HP4284A+HP42841A

SMD Wire Wound Ferrite Chip Inductors

BWLS Series



Test Instruments : Agilent E4991A Material/Impedance Analyzer

Typical **L** vs. **F** Frequency

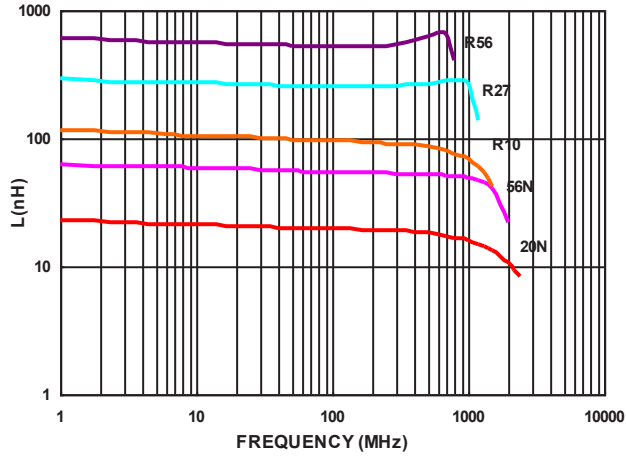

Typical **Q** vs. **F** Frequency

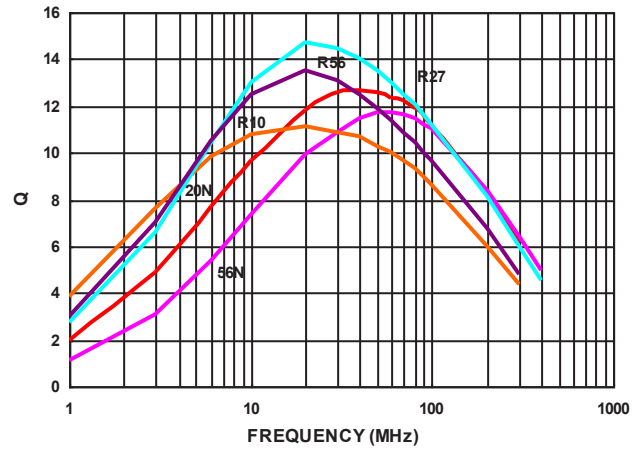

Electrical Characteristics

Part Number	Inductance (μ H)	Tolerance (\pm %)	Test Frequency (MHz)	Q Typ.	SRF (MHz) Min	RDC (Ω) Max	IDC (mA)	Color
BWLS0016110947N□00	0.047	10 / 5	7.9	17	1700	0.075	1500	Black
BWLS0016110972N□00	0.072	10 / 5	7.9	17	1700	0.12	1500	Brown
BWLS00161109R10□00	0.10	10 / 5	7.9	17	1650	0.13	1500	Red
BWLS00161109R12□00	0.12	10 / 5	7.9	17	1350	0.15	1500	Orange
BWLS00161109R15□00	0.15	10 / 5	7.9	17	1350	0.15	1450	Yellow
BWLS00161109R18□00	0.18	10 / 5	7.9	17	1150	0.15	1400	Green
BWLS00161109R22□00	0.22	10 / 5	7.9	17	1050	0.16	1350	Blue
BWLS00161109R24□00	0.24	10 / 5	7.9	17	1050	0.19	1300	Violet
BWLS00161109R27□00	0.27	10 / 5	7.9	17	1050	0.30	1050	Gray
BWLS00161109R33□00	0.33	10 / 5	7.9	17	850	0.46	1200	White
BWLS00161109R39□00	0.39	10 / 5	7.9	17	810	0.51	1200	Black
BWLS00161109R47□00	0.47	10 / 5	7.9	17	720	0.62	1050	Brown
BWLS00161109R56□00	0.56	10 / 5	7.9	17	600	0.44	850	Red
BWLS00161109R68□00	0.68	10 / 5	7.9	17	600	0.52	850	Orange
BWLS00161109R78□00	0.78	10 / 5	7.9	17	460	0.83	850	Yellow
BWLS00161109R82□00	0.82	10 / 5	7.9	17	480	0.69	750	Green
BWLS00161109R91□00	0.91	10 / 5	7.9	17	330	0.76	670	Black
BWLS001611091R0□00	1.0	10 / 5	7.9	18	310	0.81	600	Blue
BWLS001611091R2□00	1.2	10 / 5	7.9	17	270	0.87	550	Violet
BWLS001611091R5□00	1.5	10 / 5	7.9	17	270	1.06	540	Gray
BWLS001611091R8□00	1.8	10 / 5	7.9	17	230	1.10	520	White
BWLS001611092R2□00	2.2	10 / 5	7.9	17	140	1.20	500	Black
BWLS001611092R7□00	2.7	10 / 5	7.9	17	105	1.50	480	Brown
BWLS001611093R3□00	3.3	10 / 5	7.9	17	84	1.50	440	Red
BWLS001611093R9□00	3.9	10 / 5	7.9	17	80	1.60	430	Orange
BWLS001611094R7□00	4.7	10 / 5	7.9	18	69	2.10	420	Yellow
BWLS001611095R6□00	5.6	10 / 5	7.9	18	65	2.60	400	Green
BWLS001611096R8□00	6.8	10 / 5	7.9	19	55	3.10	400	Blue
BWLS001611097R8□00	7.8	10 / 5	7.9	17	47	3.50	400	Violet
BWLS001611098R2□00	8.2	10 / 5	7.9	17	42	3.80	400	Gray

BWLS00161109100□00	10	10 / 5	7.9	19	40	4.80	300	White
--------------------	----	--------	-----	----	----	------	-----	-------

Note: When ordering, please specify tolerance code. Tolerance : J=±5% , K=±10%

- Operating temperature range - 25°C ~ 105°C(Including self - temperature rise)
- IDC for Inductance drop 10% from its value without current
- Measure Equipment :
 L & Q : Agilent E4991A+Agilent HP16197A
 SRF : Agilent HP8753D/Agilent E4991A
 RDC : Chroma 16502
 IDC : HP4284A+HP42841A/HP4285A+HP42841A

Test Instruments : Agilent E4991A Material/Impedance Analyzer

Typical L vs. Frequency

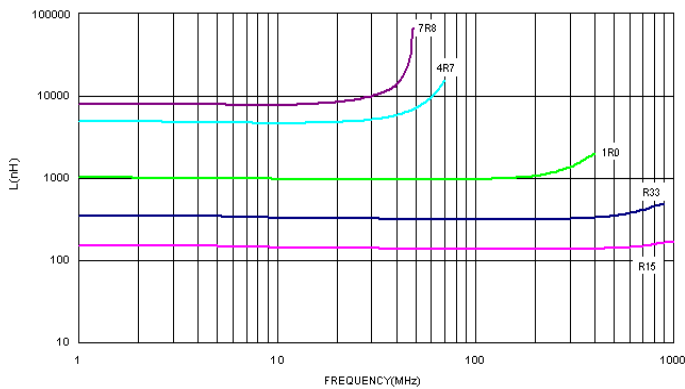

Typical Q vs. Frequency

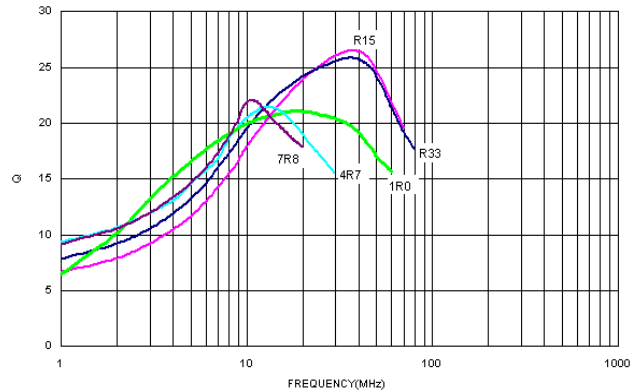

Electrical Characteristics

Part Number	Inductance (μ H)	Tolerance (\pm %)	Test Frequency (MHz)	Q Typ.	SRF (MHz) Min	RDC (Ω) Max	IDC (mA)	Color
BWLS0024171578N□00	0.078	10 / 5	7.9	19	1440	0.06	2000	Black
BWLS0024171590N□00	0.090	10	7.9	19	1200	0.07	2000	Red
BWLS00241715R11□00	0.11	10 / 5	7.9	19	1200	0.07	2000	Brown
BWLS00241715R47□00	0.47	10 / 5	7.9	19	480	0.40	800	Red
BWLS00241715R56□00	0.56	10 / 5	7.9	35	480	0.40	800	Yellow
BWLS00241715R68□00	0.68	10 / 5	7.9	20	480	0.40	800	Orange
BWLS00241715R91□00	0.91	10 / 5	7.9	20	400	0.69	700	Yellow
BWLS002417151R0□00	1.0	10 / 5	7.9	20	400	0.69	700	Yellow
BWLS002417151R2□00	1.2	10 / 5	7.9	20	330	0.83	700	Red
BWLS002417151R5□00	1.5	10 / 5	7.9	20	330	0.83	700	Green
BWLS002417151R8□00	1.8	10 / 5	7.9	20	300	1.00	650	Blue
BWLS002417152R2□00	2.2	10 / 5	7.9	20	250	1.10	650	Violet
BWLS002417152R7□00	2.7	10 / 5	7.9	23	200	1.25	650	Gray
BWLS002417153R3□00	3.3	10 / 5	7.9	23	160	1.45	650	White
BWLS002417153R9□00	3.9	10 / 5	7.9	23	90	1.50	600	Black
BWLS002417154R7□00	4.7	10 / 5	7.9	20	70	1.60	530	Brown
BWLS002417155R6□00	5.6	10 / 5	7.9	20	65	1.70	500	Red
BWLS002417156R8□00	6.8	10 / 5	7.9	20	45	1.95	470	Orange
BWLS002417158R2□00	8.2	10 / 5	2.5	16	45	2.10	450	Yellow
BWLS00241715100□00	10	10 / 5	2.5	16	40	2.40	400	Green
BWLS00241715120□00	12	10 / 5	2.5	16	38	3.20	360	Red
BWLS00241715150□00	15	10 / 5	2.5	16	30	3.55	350	Blue
BWLS00241715180□00	18	10 / 5	2.5	16	25	4.90	300	Orange
BWLS00241715220□00	22	10 / 5	2.5	16	20	5.45	270	Violet
BWLS00241715270□00	27	10 / 5	2.5	16	19	7.80	240	Gray
BWLS00241715330□00	33	10 / 5	2.5	16	16	9.50	210	White
BWLS00241715470□00	47	10 / 5	2.5	16	15	14.50	180	Brown

Note: When ordering, please specify tolerance code. Tolerance : J= \pm 5% , K= \pm 10%

- Operating temperature range - 25°C ~ 105°C(Including self - temperature rise)
- IDC for Inductance drop 10% from its value without current
- Measure Equipment :
 L & Q : Agilent E4991A+Agilent HP16197A
 SRF : Agilent E4991A
 RDC : HP4338B or Chroma 16502
 IDC : HP4284A+HP42841A/HP4285A+HP42841A

SMD Wire Wound Ferrite Chip Inductors

BWLS Series



Test Instruments : Agilent E4991A Material/Impedance Analyzer

Typical **L** vs. **F** Frequency

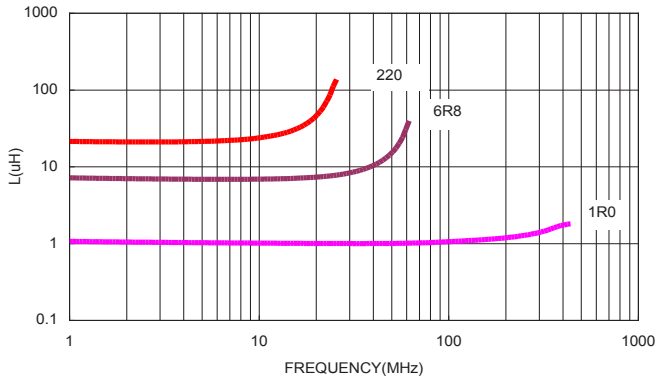

Typical **Q** vs. **F** Frequency

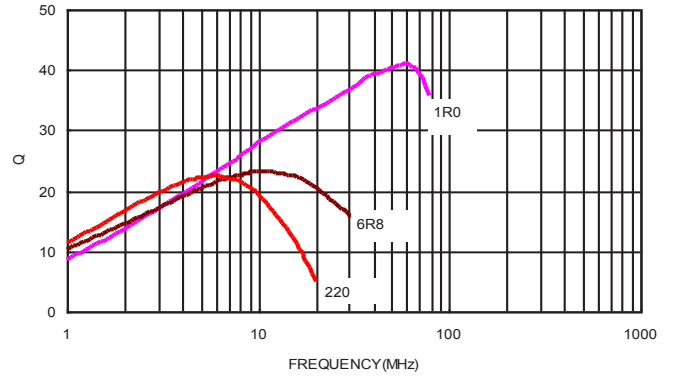

Electrical Characteristics

Part Number	Inductance (uH)	Tolerance (±%)	Test Frequency (MHz)	Q Typ.	Test Frequency (MHz)	SRF (MHz) Min	RDC (Ω) Max	IDC (mA)	Color Coding		
									1 ST	2 ND	3 RD
BWLS003025221R2□00	1.2	10 / 5	7.9	55	50	350	0.50	1200	Brown	Red	Red
BWLS003025221R5□00	1.5	10 / 5	7.9	58	50	300	0.65	1200	Brown	Green	Red
BWLS003025221R8□00	1.8	10 / 5	7.9	54	50	280	0.75	1050	Brown	Gray	Red
BWLS003025222R2□00	2.2	10 / 5	7.9	48	50	250	0.90	950	Red	Red	Red
BWLS003025222R7□00	2.7	10 / 5	7.9	51	50	200	1.00	950	Red	Violet	Red
BWLS003025223R3□00	3.3	10 / 5	7.9	58	50	200	1.15	900	Orange	Orange	Red
BWLS003025223R9□00	3.9	10 / 5	7.9	37	7.9	170	1.25	850	Orange	White	Red
BWLS003025224R7□00	4.7	10 / 5	7.9	37	7.9	130	1.35	700	Yellow	Violet	Red
BWLS003025225R6□00	5.6	10 / 5	7.9	36	7.9	110	1.45	700	Green	Blue	Red
BWLS003025226R8□00	6.8	10 / 5	7.9	33	7.9	105	1.60	600	Blue	Gray	Red
BWLS003025228R2□00	8.2	10 / 5	7.9	40	7.9	90	1.80	550	Gray	Red	Red
BWLS00302522100□00	10	10 / 5	7.9	40	7.9	85	2.40	500	Brown	Black	Orange
BWLS00302522120□00	12	10 / 5	7.9	40	7.9	80	2.40	450	Brown	Red	Orange
BWLS00302522150□00	15	10 / 5	7.9	35	7.9	38	2.40	450	Brown	Green	Orange
BWLS00302522390□00	39	10 / 5	2.5	33	2.5	26	10	170	Orange	White	Orange

Note: When ordering, please specify tolerance code. Tolerance : J=±5% , K=±10%

- Operating temperature range - 25°C ~ 105°C(Including self - temperature rise)
- IDC for Inductance drop 10% from its value without current
- Measure Equipment :
 - L & Q : Agilent E4991A+Agilent HP16197A
 - SRF : Agilent E4991A
 - RDC : HP4338B or Chroma 16502
 - IDC : HP4284A+HP42841A/HP4285A+HP42841A

Test Instruments : Agilent E4991A Material/Impedance Analyzer

Typical L vs. Frequency

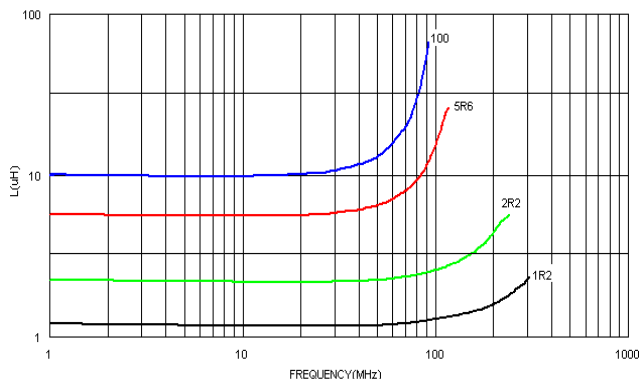

Typical Q vs. Frequency

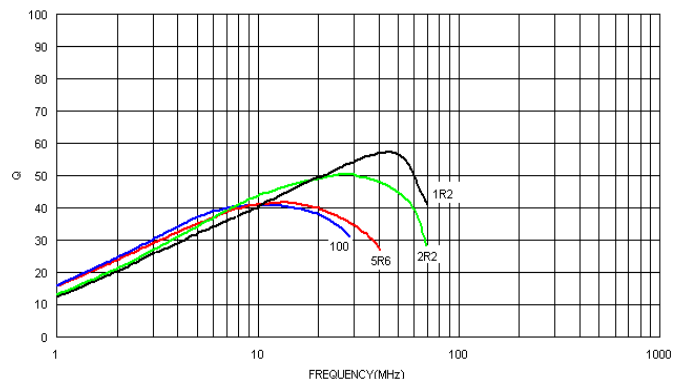

Packaging Specifications

Tape Dimensions

Figure 1

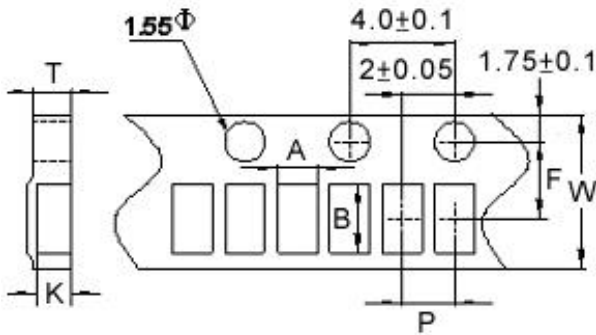
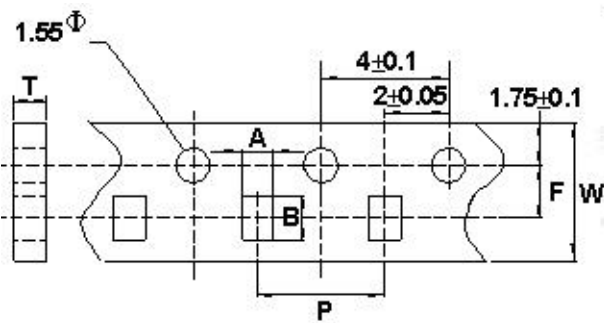
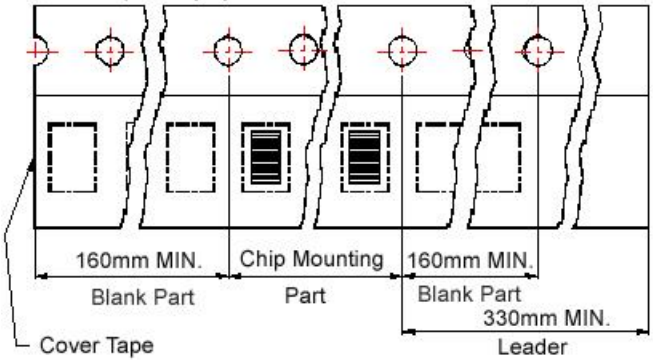

Figure 2



Tape Material

Carrier Tape: Paper
Cover Tape: Polystyrene



Carrier Tape: Paper
Cover Tape: Polystyrene

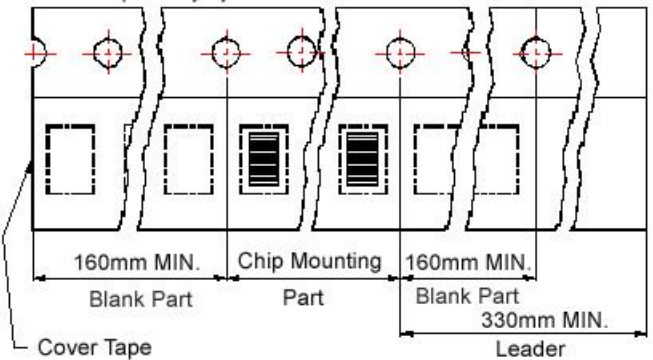
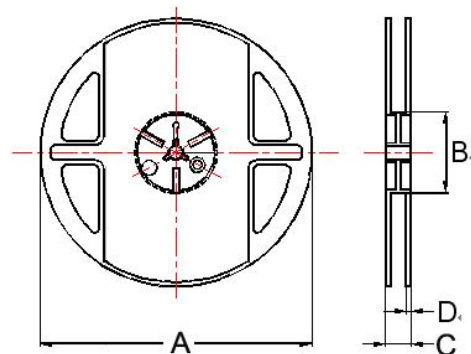
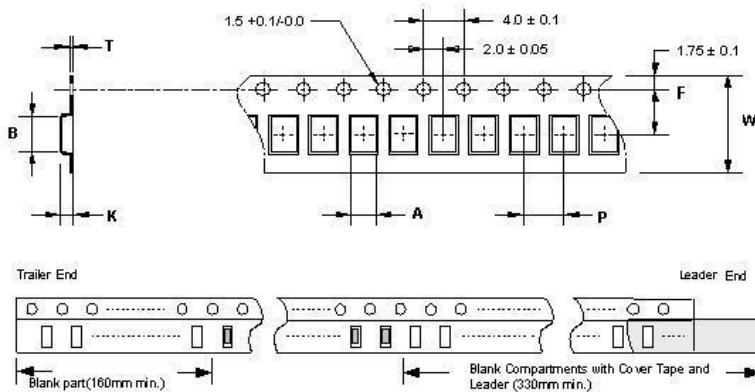

Figure 3

Reel Dimensions



SMD Wire Wound Ferrite Chip Inductors

BWLS Series



Dimensions in mm

TYPE	Fig.	Tape Dimensions							Reel Dimensions				Quantity
		A	B	T	W	P	F	K	A	B	C	D	PCS / REEL
BWLS00060404	1	0.44	0.64	0.61	8	2	3.5	045	178	60	12	1.5	4000
BWLS00100606	1	0.67	1.20	0.75	8	2	3.5	0.59	178	60	12	1.5	4000
BWLS00161109	2	1.25	1.90	1.05	8	4	3.5	-	178	60	12	1.5	4000
BWLS00241715	3	1.60	2.42	0.22	8	4	3.5	1.45	178	60	12	1.5	2000
BWLS00302522	3	2.40	2.93	0.26	8	4	3.5	2.25	178	60	12	1.5	2000

For More Information:

[Americas - prodinfo_power_americas@yageo.com](mailto:prodinfo_power_americas@yageo.com) | [Europe - prodinfo_power_emea@yageo.com](mailto:prodinfo_power_emea@yageo.com) | [Asia - prodinfo_power_asia@yageo.com](mailto:prodinfo_power_asia@yageo.com)

Performance warranty of products offered on this data sheet is limited to the parameters specified. Data is subject to change without notice. Other brand and product names mentioned herein may be trademarks or registered trademarks of their respective owners. © Copyright, 2022. Pulse Electronics, Inc. All rights reserved.

Looking for pricing, stock, or lifecycle information?

Click below to explore more details on WIN SOURCE:

 [View BWLS00241715470J00 on WIN SOURCE](#)

 [Chilisin Information](#)

Optimize Your Supply Chain with WIN SOURCE Solutions

-  Global Sourcing Solution
-  Obsolete Management
-  Cost Control Management
-  Shortage Management
-  Alternative Solution
-  Excess Inventory Management