

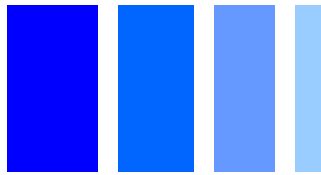

**THE DATASHEET OF  
0630CDMCDDS-R33MC**



# SMD Power Inductor 0630CDMCD/DS



**Halogen Free**

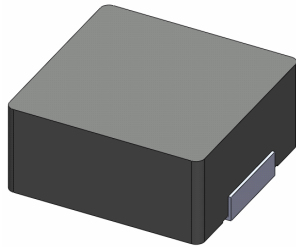

## Description

- Carbonyl powder compound molding type construction.
- Magnetically shielded.
- Low audible core noise.
- Suitable for large current.
- L × W × H: 7.3 × 6.8 × 3.0mm Max.
- Product weight: 0.73g (Ref.)
- Moisture Sensitivity Level: 1
- RoHS compliance.
- Halogen Free available.

## Dimension - [mm] (0.10μH、0.15μH)

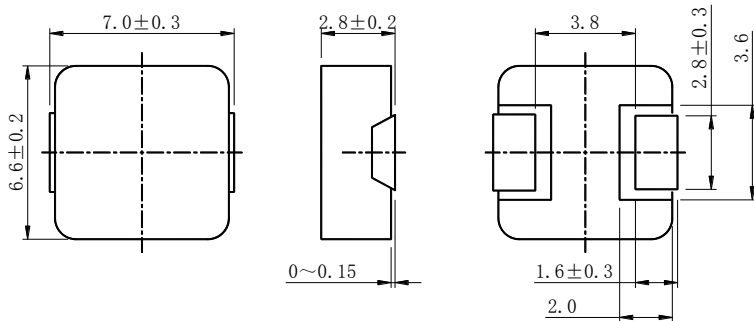

## Dimension - [mm] (0.20μH~6.8μH)

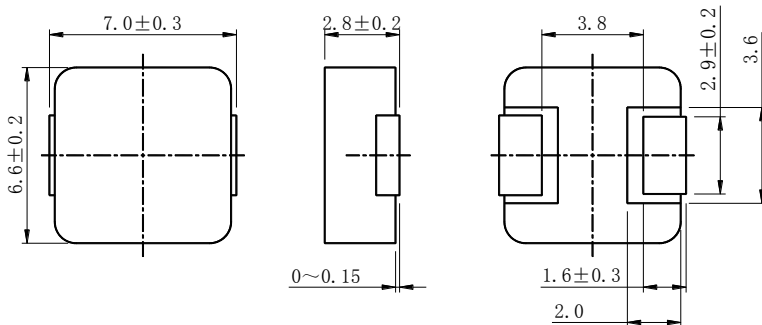

## Land pattern and Schematics - [mm]

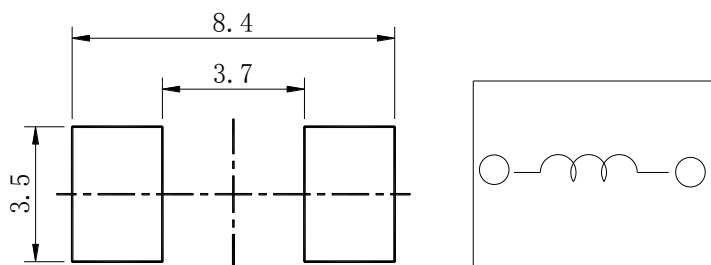

## Environmental Data

- Operating temperature range: -55°C ~ +125°C (including coil's self temperature rise)
- Storage temperature range: -55°C ~ +125°C
- Solder reflow temperature: 260 °C peak.

## Packaging

- Carrier tape and reel packaging.
- 1500pcs/Reel.

## Applications

- Ideally used in notebook, ultrabook, tablet PC, LCD display, Server application.
- High current, POL converters.
- Low profile, high current power supplies.
- Battery powered devices.
- DC/DC converters in distributed power systems.



### Electrical Characteristics

No.	品名	表示	インダクタンス ( $\mu$ H) [以内] ※1	D. C. R (m $\Omega$ ) at 25°C Max. (Typ.)	直流重畳電流 (A) (at 25°C) Max. (Typ.) ※2	温度上昇電流 (A) Typ. ※3
01	0630CDMCDDS-R10MC	R10	0.10 $\pm$ 20%	1.7(1.5)	52.5(61.8)	32.5
02	0630CDMCDDS-R15MC	R15	0.15 $\pm$ 20%	1.1(0.9)	47.6(56.0)	37.0
03	0630CDMCDDS-R20MC	R20	0.20 $\pm$ 20%	3.0(2.4)	41.0(51.0)	24.0
04	0630CDMCDDS-R22MC	R22	0.22 $\pm$ 20%	3.2(2.5)	40.0(47.5)	23.0
05	0630CDMCDDS-R33MC	R33	0.33 $\pm$ 20%	3.9(3.5)	30.0(35.5)	20.0
06	0630CDMCDDS-R47MC	R47	0.47 $\pm$ 20%	4.2(4.0)	24.6(29.0)	19.5
07	0630CDMCDDS-R56MC	R56	0.56 $\pm$ 20%	5.0(4.7)	23.8(28.0)	18.8
08	0630CDMCDDS-R68MC	R68	0.68 $\pm$ 20%	5.5(5.0)	21.8(25.6)	18.0
09	0630CDMCDDS-R75MC	R75	0.75 $\pm$ 20%	6.2(5.4)	21.0(25.0)	17.5
10	0630CDMCDDS-R82MC	R82	0.82 $\pm$ 20%	8.0(6.7)	20.8(24.5)	16.0
11	0630CDMCDDS-1R0MC	1R0	1.0 $\pm$ 20%	10.0(9.0)	18.7(22.0)	13.0
12	0630CDMCDDS-1R2MC	1R2	1.2 $\pm$ 20%	12.0(10.0)	17.8(20.9)	12.5
13	0630CDMCDDS-1R5MC	1R5	1.5 $\pm$ 20%	15.0(14.0)	17.4(20.5)	10.2
14	0630CDMCDDS-2R0MC	2R0	2.0 $\pm$ 20%	18.0(16.0)	14.8(17.5)	9.5
15	0630CDMCDDS-2R2MC	2R2	2.2 $\pm$ 20%	20.0(18.0)	14.4(17.0)	9.2
16	0630CDMCDDS-2R5MC	2R5	2.5 $\pm$ 20%	22.0(20.0)	12.0(14.0)	7.8
17	0630CDMCDDS-3R3MC	3R3	3.3 $\pm$ 20%	30.0(28.0)	11.5(13.5)	6.3
18	0630CDMCDDS-4R7MC	4R7	4.7 $\pm$ 20%	40.0(37.0)	10.5(12.3)	5.5
19	0630CDMCDDS-6R8MC	6R8	6.8 $\pm$ 20%	60.0(54.0)	7.2(8.5)	4.8
20	0630CDMCDDS-100MC	100	10 $\pm$ 20%	62.0(55.0)	4.6(5.4)	4.5

※1 Measuring frequency Inductance at 100kHz ,1.0V

※2 Saturation current: The value of DC current when the inductance is over 80% of its initial value.

※3 Temperature rise current: The actual value of DC current when temperature of coil rise is  $\Delta T=40^{\circ}\text{C}$  ( $T_a=25^{\circ}\text{C}$ ) Board conditions: FR4, Copper=70 $\mu\text{m}$ , four-layer PWB, t=1.6mm.

# SMD Power Inductor 0630CDMCD/DS



## Saturation Current & Temperature Rise Graph

— L (20°C) —  $\Delta T$

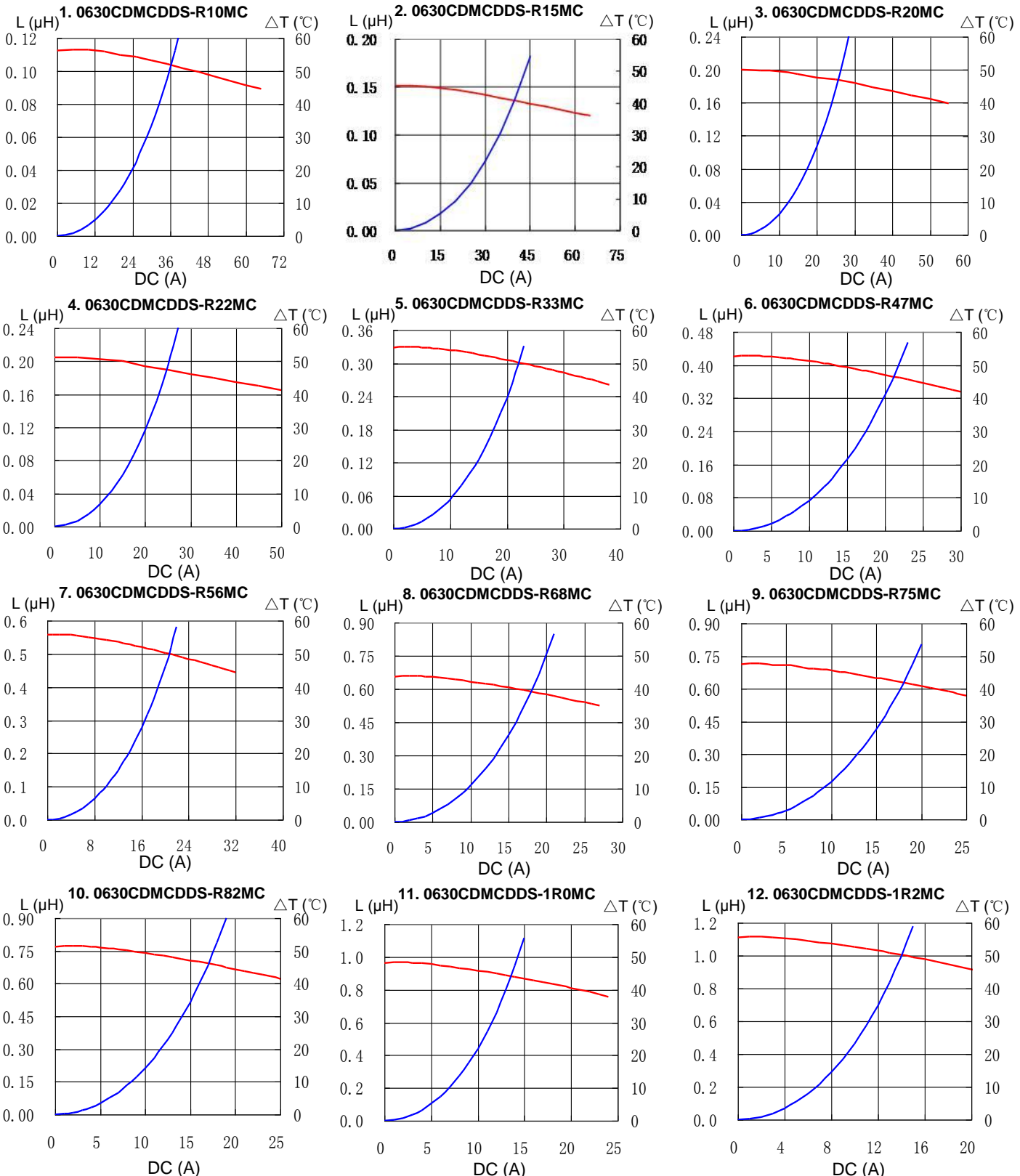

# SMD Power Inductor 0630CDMCD/DS



## Saturation Current & Temperature Rise Graph

— L (20°C)    —  $\Delta T$

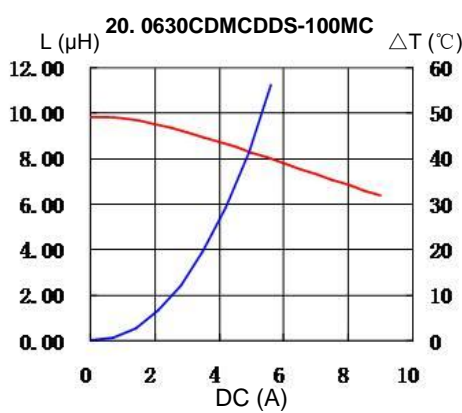
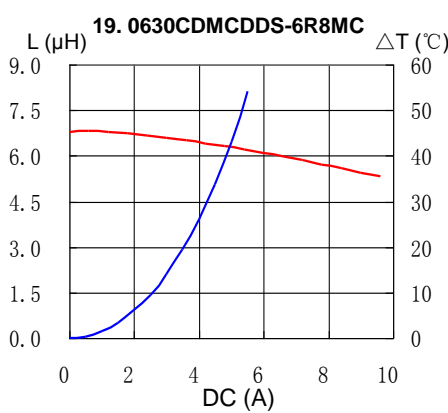
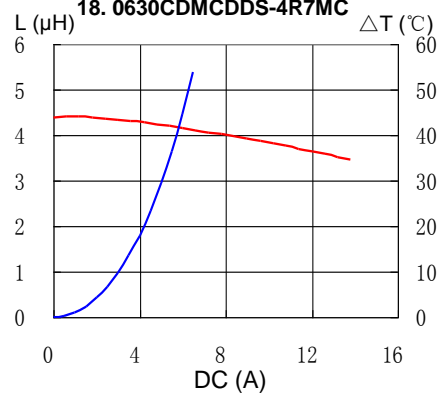
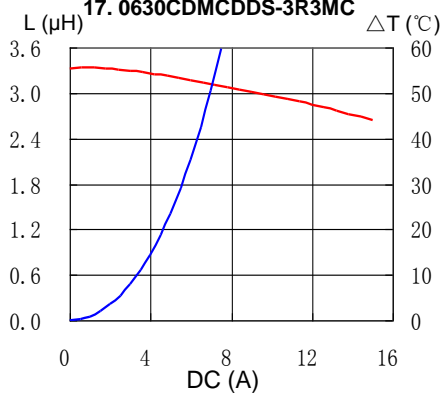
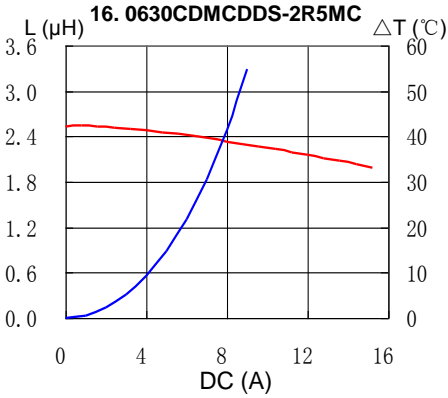
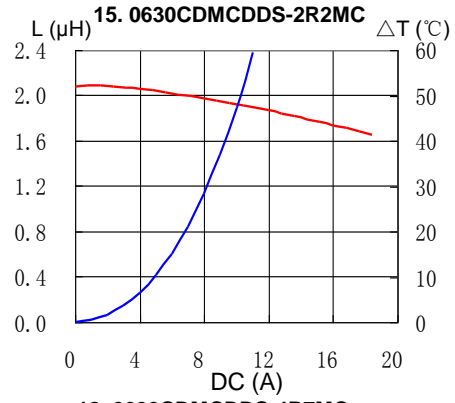
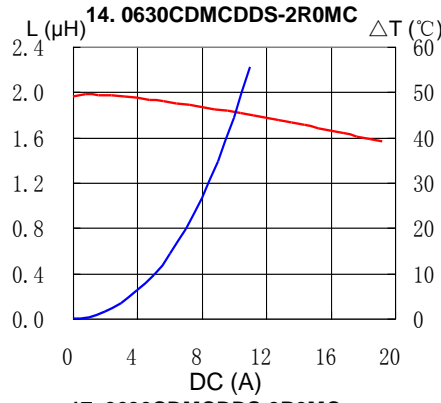
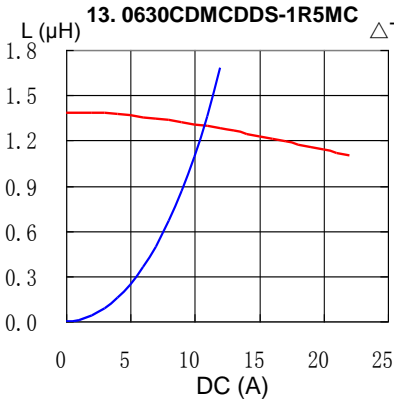

# SMD Power Inductor 0630CDMCD/DS



## Solder Reflow Condition

Heat Endurance

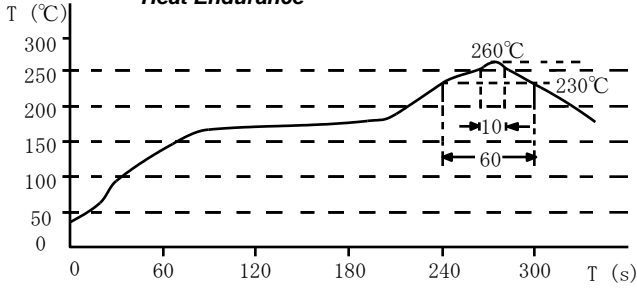

Temperature Chart

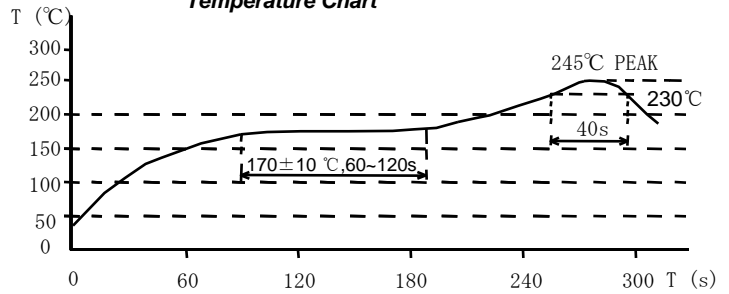

Please refer to the sales offices on our website - <http://www.sumida.com>

### Hong Kong

Tel.+852-2880-6781  
FAX.+852-2565-9600  
[sales@hk.sumida.com](mailto:sales@hk.sumida.com)

### Saitama(Japan)

Tel.+81-48-691-7300  
FAX.+81-48-691-7340  
[sales@jp.sumida.com](mailto:sales@jp.sumida.com)

### Chicago

Tel.+1-847-545-6700  
FAX. +1-847-545-6720  
[sales@us.sumida.com](mailto:sales@us.sumida.com)

### Shanghai

Tel.+86-21-5836-3299  
FAX.+86-21-5836-3266  
[shanghai.sales@cn.sumida.com](mailto:shanghai.sales@cn.sumida.com)

### Seoul

Tel.+82-2-6237-0777  
FAX.+82-2-6237-0778  
[sales@kr.sumida.com](mailto:sales@kr.sumida.com)

### Obernzell

Tel.+49-8591-937-0  
FAX. +49-8591-937-103  
[contact@eu.sumida.com](mailto:contact@eu.sumida.com)

### Shenzhen

Tel.+86-755-8291-0228  
FAX.+86-755-8291-0338  
[shenzhen.sales@cn.sumida.com](mailto:shenzhen.sales@cn.sumida.com)

### Singapore

Tel.+65-6296-3388  
FAX.+65-6841-4426  
[sales@sg.sumida.com](mailto:sales@sg.sumida.com)

### Neumarkt

Tel.+49-9181-4509-110  
FAX. +49-9181-4509-310  
[infocomp@eu.sumida.com](mailto:infocomp@eu.sumida.com)

### Taipei

Tel.+886-2-8751-2737  
FAX.+886-2-8751-2738  
[sales@tw.sumida.com](mailto:sales@tw.sumida.com)

### San Jose

Tel.+1-408-321-9660  
FAX.+1-408-321-9308  
[sales@us.sumida.com](mailto:sales@us.sumida.com)

## Looking for pricing, stock, or lifecycle information?

Click below to explore more details on WIN SOURCE:

- ⊖ [View 0630CDMCDDS-R33MC on WIN SOURCE](#)
- ⊖ [Sumida America Components Inc. Information](#)

## Optimize Your Supply Chain with WIN SOURCE Solutions

- ✓ Global Sourcing Solution
- ✓ Obsolete Management
- ✓ Cost Control Management
- ✓ Shortage Management
- ✓ Alternative Solution
- ✓ Excess Inventory Management