



**THE DATASHEET OF  
LQW15AN9N0G00D**



## CHIP COILS (CHIP INDUCTORS) LQW15AN□□□□00□ REFERENCE SPECIFICATION

### 1. Scope

This reference specification applies to chip coils (chip inductors) LQW15AN\_00 series for general electronic equipment.

### 2. Part Numbering

(Ex.)

LQ	W	15	A	N	1N5	B	0	0	D
Product ID	Structure	Dimension (L × W)	Application and characteristic	Category	Inductance	Tolerance	Performance	Electrode specification	Packaging D: taping *B: bulk

\*B: Bulk packing is also available (taping condition: however, products without reels are put in plastic bags).

### 3. Part Number and Rating

Operating temperature range	-55°C to +125°C
Storage temperature range	-55°C to +125°C

Customer Part number	Murata Part number	Inductance		Q (Min.)	DC resistance (Ω max.)	Self-resonant frequency (GHz min.)	Rated current (mA)
		Nominal value (nH)	Tolerance				
	LQW15AN1N5B00D	1.5	B: ±0.1 nH	10	0.03	18.0	1000
	LQW15AN1N5C00D	1.5	C: ±0.2 nH	10	0.03	18.0	1000
	LQW15AN1N5D00D	1.5	D: ±0.5 nH	10	0.03	18.0	1000
	LQW15AN1N6C00D	1.6	C: ±0.2 nH	10	0.07	17.0	750
	LQW15AN1N6D00D	1.6	D: ±0.5 nH	10	0.07	17.0	750
	LQW15AN1N7C00D	1.7	C: ±0.2 nH	10	0.10	17.0	640
	LQW15AN1N7D00D	1.7	D: ±0.5 nH	10	0.10	17.0	640
	LQW15AN1N8C00D	1.8	C: ±0.2 nH	10	0.16	16.0	460
	LQW15AN1N8D00D	1.8	D: ±0.5 nH	10	0.16	16.0	460
	LQW15AN2N4B00D	2.4	B: ±0.1 nH	20	0.05	15.0	850
	LQW15AN2N4C00D	2.4	C: ±0.2 nH	20	0.05	15.0	850
	LQW15AN2N4D00D	2.4	D: ±0.5 nH	20	0.05	15.0	850
	LQW15AN2N5B00D	2.5	B: ±0.1 nH	20	0.05	15.0	850
	LQW15AN2N5C00D	2.5	C: ±0.2 nH	20	0.05	15.0	850
	LQW15AN2N5D00D	2.5	D: ±0.5 nH	20	0.05	15.0	850
	LQW15AN2N6B00D	2.6	B: ±0.1 nH	20	0.05	15.0	850
	LQW15AN2N6C00D	2.6	C: ±0.2 nH	20	0.05	15.0	850
	LQW15AN2N6D00D	2.6	D: ±0.5 nH	20	0.05	15.0	850
	LQW15AN2N7B00D	2.7	B: ±0.1 nH	20	0.05	15.0	850
	LQW15AN2N7C00D	2.7	C: ±0.2 nH	20	0.05	15.0	850
	LQW15AN2N7D00D	2.7	D: ±0.5 nH	20	0.05	15.0	850
	LQW15AN2N8B00D	2.8	B: ±0.1 nH	20	0.05	15.0	850
	LQW15AN2N8C00D	2.8	C: ±0.2 nH	20	0.05	15.0	850
	LQW15AN2N8D00D	2.8	D: ±0.5 nH	20	0.05	15.0	850
	LQW15AN2N9B00D	2.9	B: ±0.1 nH	20	0.07	15.0	750
	LQW15AN2N9C00D	2.9	C: ±0.2 nH	20	0.07	15.0	750
	LQW15AN2N9D00D	2.9	D: ±0.5 nH	20	0.07	15.0	750
	LQW15AN3N0B00D	3.0	B: ±0.1 nH	20	0.07	15.0	750
	LQW15AN3N0C00D	3.0	C: ±0.2 nH	20	0.07	15.0	750
	LQW15AN3N0D00D	3.0	D: ±0.5 nH	20	0.07	15.0	750
	LQW15AN3N1B00D	3.1	B: ±0.1 nH	20	0.13	14.0	570

Customer Part number	Murata Part number	Inductance		Q (Min.)	DC resistance ( $\Omega$ max.)	Self-resonant frequency (GHz min.)	Rated current (mA)
		Nominal value (nH)	Tolerance				
	LQW15AN3N1C00D	3.1	C: $\pm 0.2$ nH	20	0.13	14.0	570
	LQW15AN3N1D00D	3.1	D: $\pm 0.5$ nH	20	0.13	14.0	570
	LQW15AN3N2B00D	3.2	B: $\pm 0.1$ nH	15	0.17	14.0	500
	LQW15AN3N2C00D	3.2	C: $\pm 0.2$ nH	15	0.17	14.0	500
	LQW15AN3N2D00D	3.2	D: $\pm 0.5$ nH	15	0.17	14.0	500
	LQW15AN3N9B00D	3.9	B: $\pm 0.1$ nH	25	0.07	10.0	750
	LQW15AN3N9C00D	3.9	C: $\pm 0.2$ nH	25	0.07	10.0	750
	LQW15AN3N9D00D	3.9	D: $\pm 0.5$ nH	25	0.07	10.0	750
	LQW15AN4N1B00D	4.1	B: $\pm 0.1$ nH	25	0.07	10.0	750
	LQW15AN4N1C00D	4.1	C: $\pm 0.2$ nH	25	0.07	10.0	750
	LQW15AN4N1D00D	4.1	D: $\pm 0.5$ nH	25	0.07	10.0	750
	LQW15AN4N3B00D	4.3	B: $\pm 0.1$ nH	25	0.07	10.0	750
	LQW15AN4N3C00D	4.3	C: $\pm 0.2$ nH	25	0.07	10.0	750
	LQW15AN4N3D00D	4.3	D: $\pm 0.5$ nH	25	0.07	10.0	750
	LQW15AN4N4B00D	4.4	B: $\pm 0.1$ nH	25	0.07	8.0	750
	LQW15AN4N4C00D	4.4	C: $\pm 0.2$ nH	25	0.07	8.0	750
	LQW15AN4N4D00D	4.4	D: $\pm 0.5$ nH	25	0.07	8.0	750
	LQW15AN4N5B00D	4.5	B: $\pm 0.1$ nH	25	0.07	8.0	750
	LQW15AN4N5C00D	4.5	C: $\pm 0.2$ nH	25	0.07	8.0	750
	LQW15AN4N5D00D	4.5	D: $\pm 0.5$ nH	25	0.07	8.0	750
	LQW15AN4N6B00D	4.6	B: $\pm 0.1$ nH	25	0.07	8.0	750
	LQW15AN4N6C00D	4.6	C: $\pm 0.2$ nH	25	0.07	8.0	750
	LQW15AN4N6D00D	4.6	D: $\pm 0.5$ nH	25	0.07	8.0	750
	LQW15AN4N7B00D	4.7	B: $\pm 0.1$ nH	25	0.07	8.0	750
	LQW15AN4N7C00D	4.7	C: $\pm 0.2$ nH	25	0.07	8.0	750
	LQW15AN4N7D00D	4.7	D: $\pm 0.5$ nH	25	0.07	8.0	750
	LQW15AN4N8B00D	4.8	B: $\pm 0.1$ nH	25	0.07	8.0	750
	LQW15AN4N8C00D	4.8	C: $\pm 0.2$ nH	25	0.07	8.0	750
	LQW15AN4N8D00D	4.8	D: $\pm 0.5$ nH	25	0.07	8.0	750
	LQW15AN4N9B00D	4.9	B: $\pm 0.1$ nH	25	0.12	8.0	600
	LQW15AN4N9C00D	4.9	C: $\pm 0.2$ nH	25	0.12	8.0	600
	LQW15AN4N9D00D	4.9	D: $\pm 0.5$ nH	25	0.12	8.0	600
	LQW15AN5N0B00D	5.0	B: $\pm 0.1$ nH	25	0.12	8.0	600
	LQW15AN5N0C00D	5.0	C: $\pm 0.2$ nH	25	0.12	8.0	600
	LQW15AN5N0D00D	5.0	D: $\pm 0.5$ nH	25	0.12	8.0	600
	LQW15AN5N1B00D	5.1	B: $\pm 0.1$ nH	25	0.12	8.0	600
	LQW15AN5N1C00D	5.1	C: $\pm 0.2$ nH	25	0.12	8.0	600
	LQW15AN5N1D00D	5.1	D: $\pm 0.5$ nH	25	0.12	8.0	600
	LQW15AN5N8B00D	5.8	B: $\pm 0.1$ nH	25	0.09	8.0	700
	LQW15AN5N8C00D	5.8	C: $\pm 0.2$ nH	25	0.09	8.0	700
	LQW15AN5N8D00D	5.8	D: $\pm 0.5$ nH	25	0.09	8.0	700
	LQW15AN6N2B00D	6.2	B: $\pm 0.1$ nH	25	0.09	8.0	700
	LQW15AN6N2C00D	6.2	C: $\pm 0.2$ nH	25	0.09	8.0	700
	LQW15AN6N2D00D	6.2	D: $\pm 0.5$ nH	25	0.09	8.0	700
	LQW15AN6N3B00D	6.3	B: $\pm 0.1$ nH	25	0.09	6.0	700
	LQW15AN6N3C00D	6.3	C: $\pm 0.2$ nH	25	0.09	6.0	700

Customer Part number	Murata Part number	Inductance		Q (Min.)	DC resistance ( $\Omega$ max.)	Self-resonant frequency (GHz min.)	Rated current (mA)
		Nominal value (nH)	Tolerance				
	LQW15AN6N3D00D	6.3	D: $\pm 0.5$ nH	25	0.09	6.0	700
	LQW15AN6N4B00D	6.4	B: $\pm 0.1$ nH	25	0.09	6.0	700
	LQW15AN6N4C00D	6.4	C: $\pm 0.2$ nH	25	0.09	6.0	700
	LQW15AN6N4D00D	6.4	D: $\pm 0.5$ nH	25	0.09	6.0	700
	LQW15AN6N5B00D	6.5	B: $\pm 0.1$ nH	25	0.09	6.0	700
	LQW15AN6N5C00D	6.5	C: $\pm 0.2$ nH	25	0.09	6.0	700
	LQW15AN6N5D00D	6.5	D: $\pm 0.5$ nH	25	0.09	6.0	700
	LQW15AN6N6B00D	6.6	B: $\pm 0.1$ nH	25	0.09	6.0	700
	LQW15AN6N6C00D	6.6	C: $\pm 0.2$ nH	25	0.09	6.0	700
	LQW15AN6N6D00D	6.6	D: $\pm 0.5$ nH	25	0.09	6.0	700
	LQW15AN6N7B00D	6.7	B: $\pm 0.1$ nH	25	0.09	6.0	700
	LQW15AN6N7C00D	6.7	C: $\pm 0.2$ nH	25	0.09	6.0	700
	LQW15AN6N7D00D	6.7	D: $\pm 0.5$ nH	25	0.09	6.0	700
	LQW15AN6N8G00D	6.8	G: $\pm 2\%$	25	0.09	6.0	700
	LQW15AN6N8H00D	6.8	H: $\pm 3\%$	25	0.09	6.0	700
	LQW15AN6N8J00D	6.8	J: $\pm 5\%$	25	0.09	6.0	700
	LQW15AN6N9G00D	6.9	G: $\pm 2\%$	25	0.13	6.0	570
	LQW15AN6N9H00D	6.9	H: $\pm 3\%$	25	0.13	6.0	570
	LQW15AN6N9J00D	6.9	J: $\pm 5\%$	25	0.13	6.0	570
	LQW15AN7N0G00D	7.0	G: $\pm 2\%$	25	0.13	6.0	570
	LQW15AN7N0H00D	7.0	H: $\pm 3\%$	25	0.13	6.0	570
	LQW15AN7N0J00D	7.0	J: $\pm 5\%$	25	0.13	6.0	570
	LQW15AN7N1G00D	7.1	G: $\pm 2\%$	25	0.13	6.0	570
	LQW15AN7N1H00D	7.1	H: $\pm 3\%$	25	0.13	6.0	570
	LQW15AN7N1J00D	7.1	J: $\pm 5\%$	25	0.13	6.0	570
	LQW15AN7N2G00D	7.2	G: $\pm 2\%$	25	0.13	6.0	570
	LQW15AN7N2H00D	7.2	H: $\pm 3\%$	25	0.13	6.0	570
	LQW15AN7N2J00D	7.2	J: $\pm 5\%$	25	0.13	6.0	570
	LQW15AN7N3G00D	7.3	G: $\pm 2\%$	25	0.13	6.0	570
	LQW15AN7N3H00D	7.3	H: $\pm 3\%$	25	0.13	6.0	570
	LQW15AN7N3J00D	7.3	J: $\pm 5\%$	25	0.13	6.0	570
	LQW15AN7N5G00D	7.5	G: $\pm 2\%$	25	0.13	6.0	570
	LQW15AN7N5H00D	7.5	H: $\pm 3\%$	25	0.13	6.0	570
	LQW15AN7N5J00D	7.5	J: $\pm 5\%$	25	0.13	6.0	570
	LQW15AN8N2G00D	8.2	G: $\pm 2\%$	25	0.14	5.5	540
	LQW15AN8N2H00D	8.2	H: $\pm 3\%$	25	0.14	5.5	540
	LQW15AN8N2J00D	8.2	J: $\pm 5\%$	25	0.14	5.5	540
	LQW15AN8N6G00D	8.6	G: $\pm 2\%$	25	0.14	5.5	540
	LQW15AN8N6H00D	8.6	H: $\pm 3\%$	25	0.14	5.5	540
	LQW15AN8N6J00D	8.6	J: $\pm 5\%$	25	0.14	5.5	540
	LQW15AN8N7G00D	8.7	G: $\pm 2\%$	25	0.14	5.5	540
	LQW15AN8N7H00D	8.7	H: $\pm 3\%$	25	0.14	5.5	540
	LQW15AN8N7J00D	8.7	J: $\pm 5\%$	25	0.14	5.5	540
	LQW15AN8N8G00D	8.8	G: $\pm 2\%$	25	0.14	5.5	540
	LQW15AN8N8H00D	8.8	H: $\pm 3\%$	25	0.14	5.5	540
	LQW15AN8N8J00D	8.8	J: $\pm 5\%$	25	0.14	5.5	540

Customer Part number	Murata Part number	Inductance		Q (Min.)	DC resistance ( $\Omega$ max.)	Self-resonant frequency (GHz min.)	Rated current (mA)
		Nominal value (nH)	Tolerance				
	LQW15AN8N9G00D	8.9	G: $\pm 2\%$	25	0.14	5.5	540
	LQW15AN8N9H00D	8.9	H: $\pm 3\%$	25	0.14	5.5	540
	LQW15AN8N9J00D	8.9	J: $\pm 5\%$	25	0.14	5.5	540
	LQW15AN9N0G00D	9.0	G: $\pm 2\%$	25	0.14	5.5	540
	LQW15AN9N0H00D	9.0	H: $\pm 3\%$	25	0.14	5.5	540
	LQW15AN9N0J00D	9.0	J: $\pm 5\%$	25	0.14	5.5	540
	LQW15AN9N1G00D	9.1	G: $\pm 2\%$	25	0.14	5.5	540
	LQW15AN9N1H00D	9.1	H: $\pm 3\%$	25	0.14	5.5	540
	LQW15AN9N1J00D	9.1	J: $\pm 5\%$	25	0.14	5.5	540
	LQW15AN9N2G00D	9.2	G: $\pm 2\%$	25	0.14	5.5	540
	LQW15AN9N2H00D	9.2	H: $\pm 3\%$	25	0.14	5.5	540
	LQW15AN9N2J00D	9.2	J: $\pm 5\%$	25	0.14	5.5	540
	LQW15AN9N3G00D	9.3	G: $\pm 2\%$	25	0.14	5.5	540
	LQW15AN9N3H00D	9.3	H: $\pm 3\%$	25	0.14	5.5	540
	LQW15AN9N3J00D	9.3	J: $\pm 5\%$	25	0.14	5.5	540
	LQW15AN9N4G00D	9.4	G: $\pm 2\%$	25	0.14	5.5	540
	LQW15AN9N4H00D	9.4	H: $\pm 3\%$	25	0.14	5.5	540
	LQW15AN9N4J00D	9.4	J: $\pm 5\%$	25	0.14	5.5	540
	LQW15AN9N5G00D	9.5	G: $\pm 2\%$	25	0.14	5.5	540
	LQW15AN9N5H00D	9.5	H: $\pm 3\%$	25	0.14	5.5	540
	LQW15AN9N5J00D	9.5	J: $\pm 5\%$	25	0.14	5.5	540
	LQW15AN9N6G00D	9.6	G: $\pm 2\%$	25	0.14	5.5	540
	LQW15AN9N6H00D	9.6	H: $\pm 3\%$	25	0.14	5.5	540
	LQW15AN9N6J00D	9.6	J: $\pm 5\%$	25	0.14	5.5	540
	LQW15AN9N7G00D	9.7	G: $\pm 2\%$	25	0.14	5.5	540
	LQW15AN9N7H00D	9.7	H: $\pm 3\%$	25	0.14	5.5	540
	LQW15AN9N7J00D	9.7	J: $\pm 5\%$	25	0.14	5.5	540
	LQW15AN9N8G00D	9.8	G: $\pm 2\%$	25	0.14	5.5	540
	LQW15AN9N8H00D	9.8	H: $\pm 3\%$	25	0.14	5.5	540
	LQW15AN9N8J00D	9.8	J: $\pm 5\%$	25	0.14	5.5	540
	LQW15AN9N9G00D	9.9	G: $\pm 2\%$	25	0.14	5.5	540
	LQW15AN9N9H00D	9.9	H: $\pm 3\%$	25	0.14	5.5	540
	LQW15AN9N9J00D	9.9	J: $\pm 5\%$	25	0.14	5.5	540
	LQW15AN10NG00D	10	G: $\pm 2\%$	25	0.17	5.5	500
	LQW15AN10NH00D	10	H: $\pm 3\%$	25	0.17	5.5	500
	LQW15AN10NJ00D	10	J: $\pm 5\%$	25	0.17	5.5	500
	LQW15AN11NG00D	11	G: $\pm 2\%$	30	0.14	5.5	500
	LQW15AN11NH00D	11	H: $\pm 3\%$	30	0.14	5.5	500
	LQW15AN11NJ00D	11	J: $\pm 5\%$	30	0.14	5.5	500
	LQW15AN12NG00D	12	G: $\pm 2\%$	30	0.14	5.5	500
	LQW15AN12NH00D	12	H: $\pm 3\%$	30	0.14	5.5	500
	LQW15AN12NJ00D	12	J: $\pm 5\%$	30	0.14	5.5	500
	LQW15AN13NG00D	13	G: $\pm 2\%$	25	0.21	5.0	430
	LQW15AN13NH00D	13	H: $\pm 3\%$	25	0.21	5.0	430
	LQW15AN13NJ00D	13	J: $\pm 5\%$	25	0.21	5.0	430
	LQW15AN15NG00D	15	G: $\pm 2\%$	30	0.16	5.0	460

Customer Part number	Murata Part number	Inductance		Q (Min.)	DC resistance ( $\Omega$ max.)	Self-resonant frequency (GHz min.)	Rated current (mA)
		Nominal value (nH)	Tolerance				
	LQW15AN15NH00D	15	H: $\pm 3\%$	30	0.16	5.0	460
	LQW15AN15NJ00D	15	J: $\pm 5\%$	30	0.16	5.0	460
	LQW15AN16NG00D	16	G: $\pm 2\%$	25	0.24	4.5	370
	LQW15AN16NH00D	16	H: $\pm 3\%$	25	0.24	4.5	370
	LQW15AN16NJ00D	16	J: $\pm 5\%$	25	0.24	4.5	370
	LQW15AN18NG00D	18	G: $\pm 2\%$	25	0.27	4.5	370
	LQW15AN18NH00D	18	H: $\pm 3\%$	25	0.27	4.5	370
	LQW15AN18NJ00D	18	J: $\pm 5\%$	25	0.27	4.5	370
	LQW15AN19NG00D	19	G: $\pm 2\%$	25	0.27	4.5	370
	LQW15AN19NH00D	19	H: $\pm 3\%$	25	0.27	4.5	370
	LQW15AN19NJ00D	19	J: $\pm 5\%$	25	0.27	4.5	370
	LQW15AN20NG00D	20	G: $\pm 2\%$	25	0.27	4.0	370
	LQW15AN20NH00D	20	H: $\pm 3\%$	25	0.27	4.0	370
	LQW15AN20NJ00D	20	J: $\pm 5\%$	25	0.27	4.0	370
	LQW15AN22NG00D	22	G: $\pm 2\%$	25	0.30	4.0	310
	LQW15AN22NH00D	22	H: $\pm 3\%$	25	0.30	4.0	310
	LQW15AN22NJ00D	22	J: $\pm 5\%$	25	0.30	4.0	310
	LQW15AN23NG00D	23	G: $\pm 2\%$	25	0.30	3.8	310
	LQW15AN23NH00D	23	H: $\pm 3\%$	25	0.30	3.8	310
	LQW15AN23NJ00D	23	J: $\pm 5\%$	25	0.30	3.8	310
	LQW15AN24NG00D	24	G: $\pm 2\%$	25	0.52	3.5	280
	LQW15AN24NH00D	24	H: $\pm 3\%$	25	0.52	3.5	280
	LQW15AN24NJ00D	24	J: $\pm 5\%$	25	0.52	3.5	280
	LQW15AN27NG00D	27	G: $\pm 2\%$	25	0.52	3.5	280
	LQW15AN27NH00D	27	H: $\pm 3\%$	25	0.52	3.5	280
	LQW15AN27NJ00D	27	J: $\pm 5\%$	25	0.52	3.5	280
	LQW15AN30NG00D	30	G: $\pm 2\%$	25	0.58	3.3	270
	LQW15AN30NH00D	30	H: $\pm 3\%$	25	0.58	3.3	270
	LQW15AN30NJ00D	30	J: $\pm 5\%$	25	0.58	3.3	270
	LQW15AN33NG00D	33	G: $\pm 2\%$	25	0.63	3.2	260
	LQW15AN33NH00D	33	H: $\pm 3\%$	25	0.63	3.2	260
	LQW15AN33NJ00D	33	J: $\pm 5\%$	25	0.63	3.2	260
	LQW15AN36NG00D	36	G: $\pm 2\%$	25	0.63	3.1	260
	LQW15AN36NH00D	36	H: $\pm 3\%$	25	0.63	3.1	260
	LQW15AN36NJ00D	36	J: $\pm 5\%$	25	0.63	3.1	260
	LQW15AN39NG00D	39	G: $\pm 2\%$	25	0.70	3.0	250
	LQW15AN39NH00D	39	H: $\pm 3\%$	25	0.70	3.0	250
	LQW15AN39NJ00D	39	J: $\pm 5\%$	25	0.70	3.0	250
	LQW15AN40NG00D	40	G: $\pm 2\%$	25	0.70	3.0	250
	LQW15AN40NH00D	40	H: $\pm 3\%$	25	0.70	3.0	250
	LQW15AN40NJ00D	40	J: $\pm 5\%$	25	0.70	3.0	250
	LQW15AN43NG00D	43	G: $\pm 2\%$	25	0.70	3.0	250
	LQW15AN43NH00D	43	H: $\pm 3\%$	25	0.70	3.0	250
	LQW15AN43NJ00D	43	J: $\pm 5\%$	25	0.70	3.0	250
	LQW15AN47NG00D	47	G: $\pm 2\%$	25	1.08	2.9	210
	LQW15AN47NH00D	47	H: $\pm 3\%$	25	1.08	2.9	210

Customer Part number	Murata Part number	Inductance		Q (Min.)	DC resistance (Ω max.)	Self-resonant frequency (GHz min.)	Rated current (mA)
		Nominal value (nH)	Tolerance				
	LQW15AN47NJ00D	47	J: ±5%	25	1.08	2.9	210
	LQW15AN51NG00D	51	G: ±2%	25	1.08	2.85	210
	LQW15AN51NH00D	51	H: ±3%	25	1.08	2.85	210
	LQW15AN51NJ00D	51	J: ±5%	25	1.08	2.85	210
	LQW15AN56NG00D	56	G: ±2%	25	1.17	2.8	200
	LQW15AN56NH00D	56	H: ±3%	25	1.17	2.8	200
	LQW15AN56NJ00D	56	J: ±5%	25	1.17	2.8	200
	LQW15AN62NG00D	62	G: ±2%	20	1.82	2.6	145
	LQW15AN62NH00D	62	H: ±3%	20	1.82	2.6	145
	LQW15AN62NJ00D	62	J: ±5%	20	1.82	2.6	145
	LQW15AN68NG00D	68	G: ±2%	20	1.96	2.5	140
	LQW15AN68NJ00D	68	J: ±5%	20	1.96	2.5	140
	LQW15AN72NG00D	72	G: ±2%	20	2.10	2.5	135
	LQW15AN72NJ00D	72	J: ±5%	20	2.10	2.5	135
	LQW15AN75NG00D	75	G: ±2%	20	2.10	2.4	135
	LQW15AN75NJ00D	75	J: ±5%	20	2.10	2.4	135
	LQW15AN82NG00D	82	G: ±2%	20	2.24	2.3	130
	LQW15AN82NJ00D	82	J: ±5%	20	2.24	2.3	130
	LQW15AN91NG00D	91	G: ±2%	20	2.38	2.1	125
	LQW15AN91NJ00D	91	J: ±5%	20	2.38	2.1	125
	LQW15ANR10J00D	100	J: ±5%	20	2.52	1.5	120
	LQW15ANR12J00D	120	J: ±5%	20	2.66	1.0	110

**4. Testing Conditions**

Unless otherwise specified	Temperature: ordinary temperature (15°C to 35°C) Humidity: ordinary humidity [25% to 85% (RH)]
In case of doubt	Temperature: 20°C±2°C Humidity: 60% to 70% (RH) Atmospheric pressure: 86 kPa to 106 kPa

**5. Appearance and Dimensions**

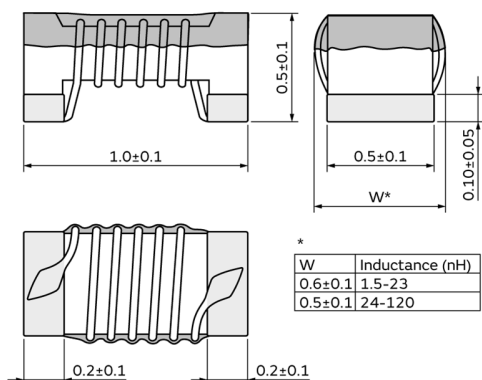

(in mm)

Unit mass (typical value): 0.0008 g

**6. Marking**

No marking.

### 7. Electrical Performance

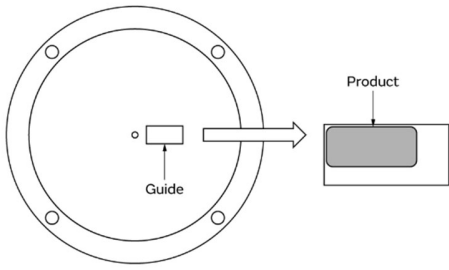
No.	Item	Specification	Test method										
7.1	Inductance	Meet chapter 3 ratings.	Measuring equipment: Keysight E4991A or the equivalent Measuring frequency: <table border="1" style="margin-left: 20px;"> <tr> <td>Inductance</td> <td colspan="2">100 MHz</td> </tr> <tr> <td rowspan="3">Q</td> <td>250 MHz</td> <td>1.5 nH to 43 nH</td> </tr> <tr> <td>200 MHz</td> <td>47 nH to 68 nH</td> </tr> <tr> <td>150 MHz</td> <td>72 nH to 120 nH</td> </tr> </table> Measuring conditions: Measurement signal level: Approx. 0 dBm Measurement terminal distance: 0.5 mm Electrical length: 10.0 mm Measuring fixture: Keysight 16197A Position the chip coil under test as shown in the measuring example below and connect it to the electrode by applying weight. Measurement example:	Inductance	100 MHz		Q	250 MHz	1.5 nH to 43 nH	200 MHz	47 nH to 68 nH	150 MHz	72 nH to 120 nH
Inductance	100 MHz												
Q	250 MHz	1.5 nH to 43 nH											
	200 MHz	47 nH to 68 nH											
	150 MHz	72 nH to 120 nH											
7.2	Q	Meet chapter 3 ratings.	 <p style="text-align: center;">Guide                      Product</p> Measuring method: see "Electrical performance: Measuring method for inductance/Q" in the chapter "16. Appendix".										
7.3	DC resistance	Meet chapter 3 ratings.	Measuring equipment: digital multimeter										
7.4	Self-resonant frequency	Meet chapter 3 ratings.	Measuring equipment: Keysight N5230A or the equivalent										
7.5	Rated current	Product temperature rise: 20°C max.	Apply the rated current specified in chapter 3.										

### 8. Mechanical Performance

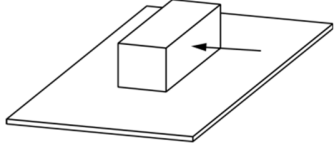
No.	Item	Specification	Test method
8.1	Shear test	No significant mechanical damage or no sign of electrode peeling off shall be observed.	Test substrate: glass-epoxy substrate Force application direction:  Applying force: 5 N Holding time: 5 s±1 s

No.	Item	Specification	Test method
8.2	Bending test	No significant mechanical damage or no sign of electrode peeling off shall be observed.	<p>Test substrate: glass-epoxy substrate (100 mm × 40 mm × 0.8 mm)            Pressurizing speed: 1 mm/s            Deflection: 2 mm            Holding time: 5 s</p> 
8.3	Vibration	Appearance shall have no significant mechanical damage.	<p>Oscillation frequency: 10 Hz to 55 Hz to 10 Hz, for approx. 1 min            Total amplitude: 1.5 mm            Test time: 3 directions perpendicular to each other, 2 h for each direction (6 h in total)</p>
8.4	Solderability	90% or more of the outer electrode shall be covered with new solder seamlessly.	<p>Flux: immersed in ethanol solution [including an activator with a chlorine conversion value of 0.06(wt)%] with a rosin content of 25(wt)% for 5 s to 10 s.            Solder: Sn-3.0Ag-0.5Cu solder            Pre-heating: 150°C±10°C/60 s to 90 s            Solder temperature: 240°C±5°C            Immersion time: 3 s±1 s</p>
8.5	Resistance to soldering heat	Appearance: No significant mechanical damage shall be observed. Inductance change rate: within ±5%	<p>Flux: immersed in ethanol solution [including an activator with a chlorine conversion value of 0.06(wt)%] with a rosin content of 25(wt)% for 5 s to 10 s.            Solder: Sn-3.0Ag-0.5Cu solder            Pre-heating: 150°C±10°C/60 s to 90 s            Solder temperature: 270°C±5°C            Immersion time: 10 s±1 s            Post-treatment: left at a room condition for 24 h±2 h</p>

## 9. Environmental Performance

The product is soldered on a substrate for test.

No.	Item	Specification	Test method
9.1	Heat resistance	Appearance: No significant mechanical damage shall be observed. Inductance change rate: within ±5% Q change rate: within ±20%	<p>Temperature: 125°C±2°C            Test time: 1000 h (+48 h, -0 h)            Post-treatment: left at a room condition for 24 h±2 h</p>
9.2	Cold resistance	Appearance: No significant mechanical damage shall be observed. Inductance change rate: within ±5% Q change rate: within ±20%	<p>Temperature: -55°C±2°C            Test time: 1000 h (+48 h, -0 h)            Post-treatment: left at a room condition for 24 h±2 h</p>
9.3	Humidity	Appearance: No significant mechanical damage shall be observed. Inductance change rate: within ±5% Q change rate: within ±20%	<p>Temperature: 70°C±2°C            Humidity: 90% (RH) to 95% (RH)            Test time: 1000 h (+48 h, -0 h)            Post-treatment: left at a room condition for 24 h±2 h</p>
9.4	Temperature cycle	Appearance: No significant mechanical damage shall be observed. Inductance change rate: within ±5% Q change rate: within ±20%	<p>Single cycle conditions:            Step 1: -55°C±2°C/30 min±3 min            Step 2: ordinary temperature/10 min to 15 min            Step 3: +125°C±2°C/30 min±3 min            Step 4: ordinary temperature/10 min to 15 min            Number of testing: 10 cycles            Post-treatment: left at a room condition for 24 h±2 h</p>

### 10. Specification of Packaging

#### 10.1 Appearance and dimensions of tape (8 mm width/paper tape)

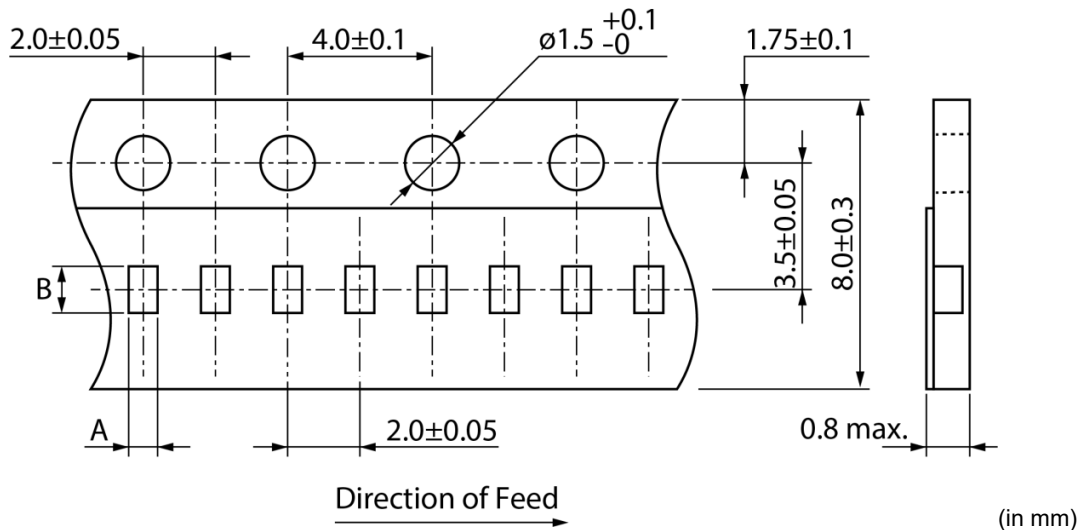

Inductance	A* (mm) (Dimensional tolerance $\pm 0.03$ )	B* (mm) (Dimensional tolerance $\pm 0.03$ )
1N5, 2N4 to 2N8, 3N9 to 4N8, 5N8 to 6N8, 8N2 to 9N9, 11N, 12N, 15N	0.69	1.18
1N6 to 1N8, 2N9, 3N0, 3N1, 3N2, 4N9 to 5N1, 6N9 to 7N5, 10N, 13N, 16N to 23N, R10, R12	0.66	1.18
24N to 91N	0.64	1.18

\*Typical value

#### 10.2 Taping specifications

Packing quantity (Standard quantity)	10000 pcs/reel
Packing method	The products are placed in embossed cavities of a base tape and sealed by a cover tape.
Feed hole position	The feed holes on the base tape are on the right side when the cover tape is pulled toward the user.
Joint	The base tape and the cover tape are seamless.
Number of missing products	Number of missing products within 0.025% of the number per reel or 1 pc., whichever is greater, and are not continuous. The specified quantity per reel is kept.

#### 10.3 Break down force of tape

Break down force of cover tape	5 N min.
--------------------------------	----------

#### 10.4 Peeling off force of cover tape

Speed of peeling off	300 mm/min
Peeling off force	0.1 N to 0.6 N (The lower limit is for typical value.)

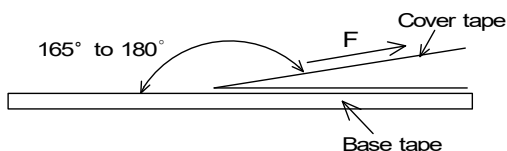

### 10.5 Dimensions of leader section, trailer section and reel

A vacant section is provided in the leader (start) section and trailer (end) section of the tape for the product. The leader section is further provided with an area consisting only of the cover tape (or top tape). (See the diagram below.)



### 10.6 Marking for reel

Customer part number, Murata part number, inspection number (\*1), RoHS marking (\*2), quantity, etc.

<p>*1 Expression of inspection No.:</p> <p>□□    ○○○○    ◇◇◇◇</p> <p>(1)    (2)    (3)</p>	<p>(1) Factory code</p> <p>(2) Date</p> <p>First digit: year/last digit of year</p> <p>Second digit: month/Jan. to Sep.→1 to 9, Oct. to Dec.→O, N, D</p> <p>Third, Fourth digit: day</p> <p>(3) Serial No.</p>
<p>*2 Expression of RoHS marking:</p> <p>ROHS-    Y    (△)</p> <p>(1)    (2)</p>	<p>(1) RoHS regulation conformity</p> <p>(2) Murata classification number</p>

### 10.7 Marking on outer box (corrugated box)

Customer name, purchasing order number, customer part number, Murata part number, RoHS marking (\*2), quantity, etc.

### 10.8 Specification of outer box



Dimensions of outer box (mm)			Standard reel quantity in outer box (reel)
W	D	H	
186	186	93	5
* Above outer box size is typical. It depends on a quantity of an order.			

## 11. ⚠Caution

### 11.1 Restricted applications

Please contact us before using our products for the applications listed below which require especially high reliability for the prevention of defects which might directly cause damage to the third party's life, body or property.

- |                               |   |                              |   |
|-------------------------------|---|------------------------------|---|
| (1) Aircraft equipment        | (2) Aerospace equipment   | (3) Undersea equipment       | (4) Power plant control equipment       |
| (5) Medical equipment         | (6) Transportation equipment (vehicles, trains, ships, etc.)  | (7) Traffic signal equipment | (8) Disaster/crime prevention equipment |
| (9) Data-processing equipment | (10) Applications of similar complexity and/or reliability requirements to the applications listed in the above |                              |   |

### 11.2 Precautions on rating

Avoid using in exceeded the rated temperature range, rated voltage, or rated current. Usage when the ratings are exceeded could lead to wire breakage, burning, or other serious fault.

### 11.3 Inrush current

If an inrush current (or pulse current or rush current) that significantly exceeds the rated current is applied to the product, overheating could occur, resulting in wire breakage, burning, or other serious fault.

### 11.4 Corrosive gas

Please refrain from use since contact with environments with corrosive gases (sulfur gas [hydrogen sulfide, sulfur dioxide, etc.], chlorine, ammonia, etc.) or oils (cutting oil, silicone oil, etc.) that have come into contact with the previously stated corrosive gas environment will result in deterioration of product quality or an open from deterioration due to corrosion of product electrode, etc. We will not bear any responsibility for use under these environments.

## 12. Precautions for Use

This product is for use only with reflow soldering. It is designed to be mounted by soldering. If you want to use other mounting method, for example, using a conductive adhesive, please consult us beforehand. Also, if repeatedly subjected to temperature cycles or other thermal stress, due to the difference in the coefficient of thermal expansion with the mounting substrate, the solder (solder fillet part) in the mounting part may crack. The occurrence of cracks due to thermal stress is affected by the size of the land where mounted, the solder volume, and the heat dissipation of the mounting substrate. Carefully design it when a large change in ambient temperature is assumed.

### 12.1 Land dimensions

The following diagram shows the recommended land dimensions for reflow soldering. The land dimensions are designed in consideration of electrical characteristics and mountability. Use of other land dimensions may preclude achievement of performance. In some cases, it may result in poor solderability, including positional shift. If you use other land pattern, consider it adequately.

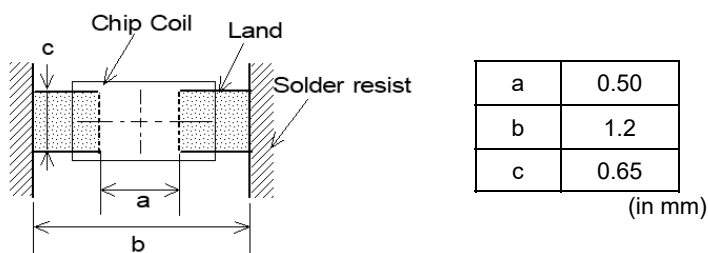

### 12.2 Flux and solder used

Flux	<ul style="list-style-type: none"> <li>• Use a rosin-based flux that includes an activator with a chlorine conversion value of 0.06(wt)% to 0.1(wt)%.</li> <li>• Do not use a highly acidic flux with a halide content exceeding 0.2(wt)% (chlorine conversion value).</li> <li>• Do not use a water-soluble flux.</li> </ul>
Solder	<ul style="list-style-type: none"> <li>• Use Sn-3.0Ag-0.5Cu solder.</li> <li>• Standard thickness of solder paste: 100 μm to 150 μm</li> </ul>

If you want to use a flux other than the above, please consult our technical department.

### 12.3 Soldering conditions (reflow)

- Pre-heating should be in such a way that the temperature difference between solder and product surface is limited to 150°C max.  
Cooling into solvent after soldering also should be in such a way that the temperature difference is limited to 100°C max.  
Insufficient pre-heating may cause cracks on the product, resulting in the deterioration of product quality.
- Standard soldering profile and the limit soldering profile is as follows.  
The excessive limit soldering conditions may cause leaching of the electrode and/or resulting in the deterioration of product quality.



	Standard profile	Limit profile
Pre-heating	150°C to 180°C/90 s±30 s	150°C to 180°C/90 s±30 s
Heating	Above 220°C/30 s to 60 s	Above 230°C/60 s max.
Peak temperature	245°C±3°C	260°C/10 s
Number of reflow cycles	2 times	2 times

### 12.4 Reworking with soldering iron

The following requirements must be met to rework a soldered product using a soldering iron.

Item	Requirement
Pre-heating	150°C/approx. 1 min
Tip temperature of soldering iron	350°C max.
Power consumption of soldering iron	80 W max.
Tip diameter of soldering iron	ø3 mm max.
Soldering time	3 s (+1 s, -0 s)
Number of reworking operations	2 times max.
* Avoid a direct contact of the tip of the soldering iron with the product. Such a direction contact may cause cracks in the ceramic body due to thermal shock.	

### 12.5 Solder volume

Solder shall be used not to increase the volume too much.



An increased solder volume increases mechanical stress on the product. Exceeding solder volume may cause the failure of mechanical or electrical performance.

### 12.6 Product's location

The following shall be considered when designing and laying out PCBs.

(1) PCB shall be designed so that products are not subject to mechanical stress due to warping the board.

[Products direction]

Products shall be located in the sideways direction (length:  $a < b$ ) to the mechanical stress.



(2) Components location on PCB separation

It is effective to implement the following measures, to reduce stress in separating the board.

It is best to implement all of the following three measures; however, implement as many measures as possible to reduce stress.

Contents of measures	Stress level
(1) Turn the mounting direction of the component parallel to the board separation surface.	$A > D^{*1}$
(2) Add slits in the board separation part.	$A > B$
(3) Keep the mounting position of the component away from the board separation surface.	$A > C$
*1 $A > D$ is valid when stress is added vertically to the perforation as with hand separation. If a cutting disc is used, stress will be diagonal to the PCB, therefore $A > D$ is invalid.	



(3) Mounting components near screw holes

When a component is mounted near a screw hole, it may be affected by the board deflection that occurs during the tightening of the screw.

Mount the component in a position as far away from the screw holes as possible.



### 12.7 Handling of substrate

After mounting products on a substrate, do not apply any stress to the product caused by bending or twisting to the substrate when cropping the substrate, inserting and removing a connector from the substrate or tightening screw to the substrate. Excessive mechanical stress may cause cracking in the product.



Bending

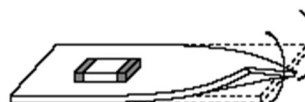

Twisting

### 12.8 Cleaning

The product shall be cleaned under the following conditions.

- (1) The cleaning temperature shall be 60°C max. If isopropyl alcohol (IPA) is used, the cleaning temperature shall be 40°C max.
- (2) Perform ultrasonic cleaning under the following conditions. Exercise caution to prevent resonance phenomenon in mounted products and the PCB.

Item	Requirement
Power	20 W/L max.
Time	5 min max.
Frequency	28 kHz to 40 kHz

- (3) Cleaner

Alcohol-based cleaner: IPA

Aqueous agent: PINE ALPHA ST-100S

- (4) There shall be no residual flux or residual cleaner. When using aqueous agent, rinse the product with deionized water adequately and completely dry it so that no cleaner is left.

\* For other cleaning, consult our technical department.

### 12.9 Storage and transportation

Storage period	Use the product within 12 months after delivery. If you do not use the product for more than 12 months, check solderability before using it.
Storage conditions	<ul style="list-style-type: none"> <li>• The products shall be stored in a room not subject to rapid changes in temperature and humidity. The recommended temperature range is -10°C to +40°C. The recommended relative humidity range is 15% to 85%.</li> <li>• Keeping the product in corrosive gases, such as sulfur, chlorine gas or acid, oxidizes the electrode, resulting in poor solderability or corrosion of the coil wire of the product.</li> <li>• Do not keep products in bulk packaging. Doing so may cause collision between the products or between the products and other products, resulting in core chipping or wire breakage.</li> <li>• Do not place the products directly on the floor; they should be placed on a palette so that they are not affected by humidity or dust.</li> <li>• Avoid keeping the products in a place exposed to direct sunlight, heat or vibration.</li> </ul>
Transportation	Excessive vibration and impact reduces the reliability of the products. Exercise caution when handling the products.

### 12.10 Resin coating

The inductance value may change due to high cure-stress of resin to be used for coating/molding products.

A wire breakage issue may occur by mechanical stress caused by the resin, amount/cured shape of resin, or operating condition etc. Some resin contains some impurities or chloride possible to generate chlorine by hydrolysis under some operating condition may cause corrosion of wire of coil, leading to wire breakage.

So, please pay your careful attention when you select resin in case of coating/molding the products with the resin.

Prior to use the coating resin, please make sure no reliability issue is observed by evaluating products mounted on your board.

### 12.11 Handling of product

- Sharp material such as a pair of tweezers or other material such as bristles of cleaning brush, shall not be touched to the winding portion to prevent the breaking of wire.
- Mechanical shock should not be applied to the products mounted on the board to prevent the breaking of the core.

### 12.12 Handling with mounting equipment

- With some types of mounting equipment, a support pin pushes up the product from the bottom of the base (paper) tape when the product is sucked with the pick-up nozzle.  
When using this type of equipment, detach the support pin to prevent the breaking of wire on the product.
- In some cases, the laser recognition function of the mounting equipment may not recognize this product correctly. Please contact us when using laser recognition. (There is no problem with the permeation and reflection type.)

### 13. Note

- (1) Please make sure that your product has been evaluated in view of your specifications with our product being mounted to your product.
- (2) You are requested not to use our product deviating from the reference specifications.
- (3) The contents of this reference specification are subject to change without advance notice. Please approve our product specifications or transact the approval sheet for product specifications before ordering.

### 14. Appendix

Electrical performance: Measuring method for inductance/Q (Q measurement is applicable only when the Q value is included in the rating table.)

Perform measurement using the method described below. (Perform correction for the error deriving from the measuring terminal.)

(1) Residual elements and stray elements of the measuring terminal can be expressed by the F parameter for the 2-pole terminal as shown in the figure below.

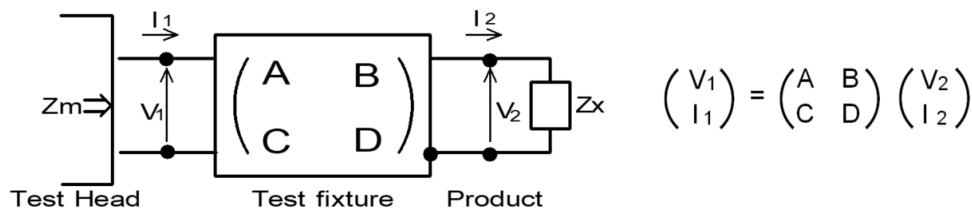

(2) The product's impedance value (Zx) and measured impedance value (Zm) can be expressed as shown below, by using the respective current and voltage for input/output.

$$Z_m = \frac{V_1}{I_1} \quad Z_x = \frac{V_2}{I_2}$$

(3) Thus, the relationship between the product's impedance value (Zx) and measured impedance value (Zm) is as follows.

$Z_x = \alpha \frac{Z_m - \beta}{1 - Z_m \Gamma}$	<p>Here,</p> <p><math>\alpha = D/A = 1</math></p> <p><math>\beta = B/D = Z_{sm} - (1 - Y_{om} Z_{sm}) Z_{ss}</math></p> <p><math>\Gamma = C/A = Y_{om}</math></p> <p>Zsm: measured impedance of short chip                  Zss: residual impedance of short chip (0.556 nH)                  Yom: measured admittance when measuring terminal is open</p>
---	--

(4) Calculate inductance Lx and Qx using the equations shown below.

$L_x = \frac{\text{Im}(Z_x)}{2\pi f}$	Lx: inductance of chip coil Qx: Q of chip coil f: measuring frequency
$Q_x = \frac{\text{Im}(Z_x)}{\text{Re}(Z_x)}$	

## Looking for pricing, stock, or lifecycle information?

Click below to explore more details on WIN SOURCE:

- ⊖ [View LQW15AN9N0G00D on WIN SOURCE](#)
- ⊖ [Murata Electronics North America Information](#)

## Optimize Your Supply Chain with WIN SOURCE Solutions

- ✓ Global Sourcing Solution
- ✓ Obsolete Management
- ✓ Cost Control Management
- ✓ Shortage Management
- ✓ Alternative Solution
- ✓ Excess Inventory Management