



**THE DATASHEET OF
AH1913-W-7**



Description

The AH1913 is an ultra-high sensitivity, digital-omnipolar, Hall effect switch IC from Diodes broad Hall effect switches family. Thanks to the hibernating clocking system, the average supply current is only 12 μ A at 1.8V, which makes the AH1913 a perfect fit for battery-powered consumer products, smart phones, E-meters, smoke detectors, and IoT devices. AH1913 can operate wider range of supply voltage (1.6V to 5.5V) and supports low-voltage system microcontrollers, which provides great flexibility for system design. The advanced chopper-stabilized design provides superior stability on switch-operating point over temperature and supply voltage range. The high ESD level of up to 6KV helps improve the system robustness.

The output is activated with either a north or south pole of sufficient magnetic field strength. When the magnetic flux density (B) perpendicular to the package is larger than operate point (B_{OP}), the output turns on (pulled low) and held until B is lower than release point (B_{RP}).

The AH1913 comes with industry standard SC59 and X1-DFN1216-4 package

Features

- Omnipolar Operation (North or South Pole)
- Supply Voltage of 1.6V to 5.5V
- Micropower Operation
- Chopper-Stabilized Design Provides:
 - Superior Temperature Stability
 - Minimal Switch Point Drift
 - Enhanced Immunity to Physical Stress
- -40°C to +85°C Operating Temperature
- High ESD Capability of 6kV (Human Body Model)
- Small Low Profile, SC59 and X1-DFN1216-4 Package
- **Totally Lead-Free & Fully RoHS Compliant (Notes 1 & 2)**
- **Halogen and Antimony Free. "Green" Device (Note 3)**

- Notes:
1. No purposely added lead. Fully EU Directive 2002/95/EC (RoHS), 2011/65/EU (RoHS 2) & 2015/863/EU (RoHS 3) compliant.
 2. See <https://www.diodes.com/quality/lead-free/> for more information about Diodes Incorporated's definitions of Halogen- and Antimony-free, "Green" and Lead-free.
 3. Halogen- and Antimony-free "Green" products are defined as those which contain <900ppm bromine, <900ppm chlorine (<1500ppm total Br + Cl) and <1000ppm antimony compounds.

Pin Assignments

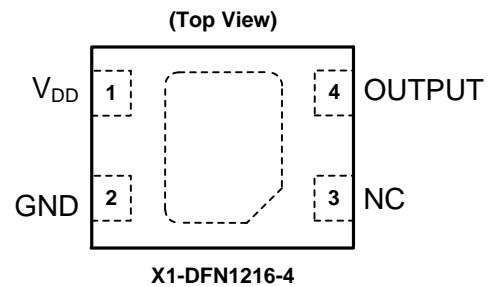
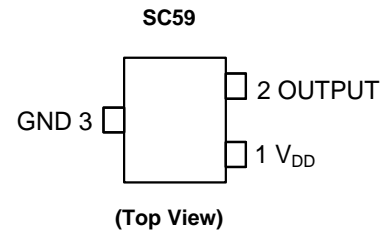

Applications

- Smart Cover or Dock Detect for Cellular Phones and Tablets
- Position Detect for Digital Still, Video Cameras, and Handheld Gaming Consoles
- Door, Lids, and Tray Position Detect Switches Home Appliances and Industrial Applications
- Level, Proximity, Position Switches, E-Locks, and Smoke Detectors
- Contactless Switches in Home Appliances and Industrial Applications
- Medical Devices, IoT Systems

Typical Applications Circuit

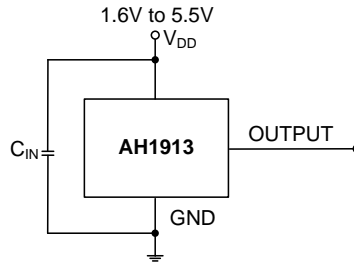

Note: 4. C_{IN} is for power stabilization and to strengthen the noise immunity; the recommended capacitance is 100nF typical and should be placed as close to the supply pin as possible.

Pin Descriptions

(1) Package: SC59

Pin Number	Pin Name	Function
1	V_{DD}	Power Supply Input
2	OUTPUT	Output Pin
3	GND	Ground Pin

(2) Package: X1-DFN1216-4

Pin Number	Pin Name	Function
1	V_{DD}	Power Supply Input
2	GND	Ground Pin
3	NC	No Connection (Note 5)
4	OUTPUT	Output Pin

Note: 5. NC is "No Connection" pin and is not connected internally. This pin can be left open or tied to ground.

Functional Block Diagram

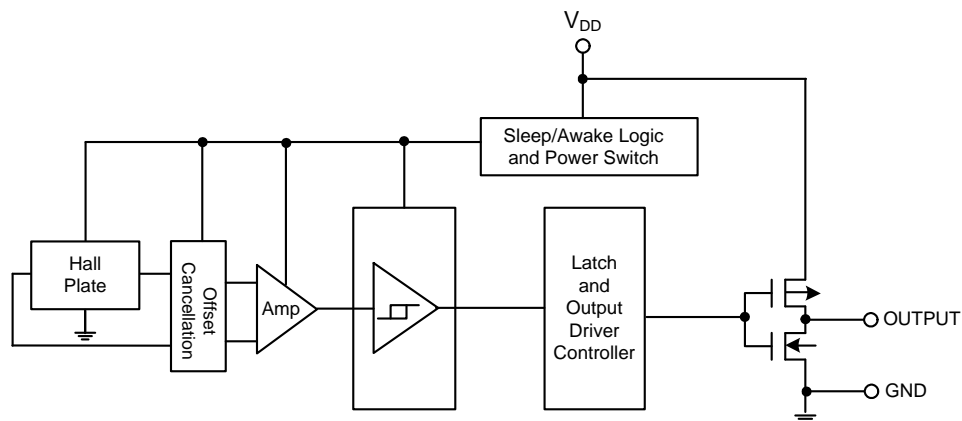

Absolute Maximum Ratings (Note 6) (@ $T_A = +25^\circ\text{C}$, unless otherwise specified.)

Symbol	Parameter	Rating	Unit
V_{DD}	Supply Voltage (Note 7)	6	V
V_{DD_REV}	Reverse Supply Voltage	-0.3	V
I_{OUTPUT}	Output Current (Source and Sink)	1	mA
B	Magnetic Flux Density	Unlimited	
P_D	Package Power Dissipation	SC59 and X1-DFN1216-4	230 mW
T_s	Storage Temperature Range	-65 to +150	$^\circ\text{C}$
T_J	Maximum Junction Temperature	150	$^\circ\text{C}$
ESD HBM	Human Body Model (HBM) ESD Capability	6	kV

- Notes:
- Stresses greater than the *Absolute Maximum Ratings* specified above can cause permanent damage to the device. These are stress ratings only; functional operation of the device at these or any other conditions exceeding those indicated in this specification is not implied. Device reliability may be affected by exposure to absolute maximum rating conditions for extended periods of time.
 - The absolute maximum V_{DD} of 6V is a transient stress rating and is not meant as a functional operating condition. It is not recommended to operate the device at the absolute maximum rated conditions for any period of time.

Recommended Operating Conditions (@ $T_A = +25^\circ\text{C}$, unless otherwise specified.)

Symbol	Parameter	Conditions	Rating	Unit
V_{DD}	Supply Voltage	Operating	1.6 to 5.5	V
T_A	Operating Temperature Range	Operating	-40 to +85	$^\circ\text{C}$

Electrical Characteristics (@ $T_A = +25^\circ\text{C}$, unless otherwise specified.)

Symbol	Parameter	Conditions	Min	Typ	Max	Unit
V_{OL}	Output Low Voltage (on)	$I_{OUT} = 0.1\text{mA}$	—	0.1	0.25	V
V_{OH}	Output High Voltage (off)	$I_{OUT} = -0.1\text{mA}$	$V_{DD} - 0.25$	$V_{DD} - 0.1$	—	V
$I_{DD}(\text{awake})$	Supply Current	During 'Awake' Period, $V_{DD} = 1.8\text{V}$	—	0.72	—	mA
$I_{DD}(\text{sleep})$		During 'Sleep' Period, $V_{DD} = 1.8\text{V}$	—	0.36	—	μA
$I_{DD}(\text{avg})$	Average Supply Current	$V_{DD} = 1.8\text{V}$	—	12	22	μA
		$T_A = -40^\circ\text{C} \sim 85^\circ\text{C}$, $V_{DD} = 1.6\text{V to } 5.5\text{V}$	—	12	41	μA
T_{awake}	Awake Time	(Note 7)	30	45	80	μs
T_{period}	Period	(Note 7)	1.4	2.8	5.6	ms
D.C.	Duty Cycle	—	—	1.6	—	%

- Note:
- When power is initially turned on, the operating V_{DD} (1.6V to 5.5V) must be applied to guaranteed the output sampling. The output state is valid after the second operating cycle (typical 5.6ms).

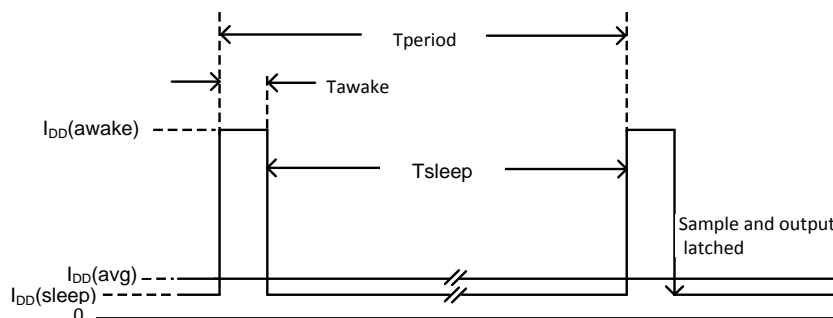

Magnetic Characteristics (Note 8) ($T_A = -25^\circ\text{C}$, $V_{DD} = 3\text{V}$, unless otherwise specified)

(1mT=10 Gauss)

Symbol	Characteristics	Test Condition	Min	Typ	Max	Unit
B _{OPS} (South Pole to the Part Marking Side)	Operation Point	—	9	18	27	Gauss
		$V_{DD} = 1.6\text{V to } 5.5\text{V}$ $T_A = -40^\circ\text{C to } +85^\circ\text{C}$	6	18	30	
—		-27	-18	-9		
B _{OPN} (North Pole to the Part Marking Side).		$V_{DD} = 1.6\text{V to } 5.5\text{V}$ $T_A = -40^\circ\text{C to } +85^\circ\text{C}$	-30	-18	-6	
	—	3	11	20		
B _{RPS} (South Pole to the Part Marking Side)	Release Point	$V_{DD} = 1.6\text{V to } 5.5\text{V}$ $T_A = -40^\circ\text{C to } +85^\circ\text{C}$	2	11	24	
		—	-20	-11	-3	
B _{RPN} (North Pole to the Part Marking Side)		$V_{DD} = 1.6\text{V to } 5.5\text{V}$ $T_A = -40^\circ\text{C to } +85^\circ\text{C}$	-24	-11	-2	
		—	2	7	-	
B _{HY} ($ B_{OPX} - B_{RPX} $)	Hysteresis	—	2	7	-	

Notes: 8. Maximum and minimum parameters values over operating temperature range are not tested in production; they are guaranteed by design, characterization, and process control. The magnetic characteristics can vary with supply voltage, operating temperature, and after soldering.

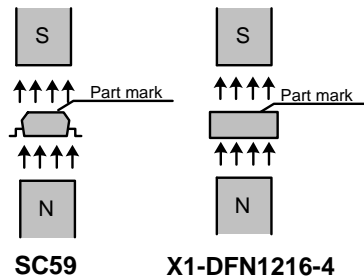
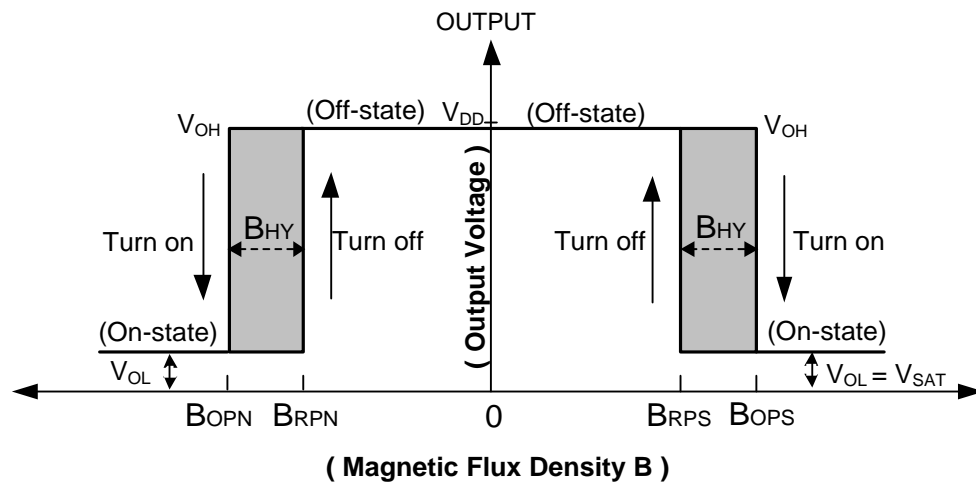

Typical Operating Characteristics

Output Switch Operate and Release Points (Magnetic Thresholds)

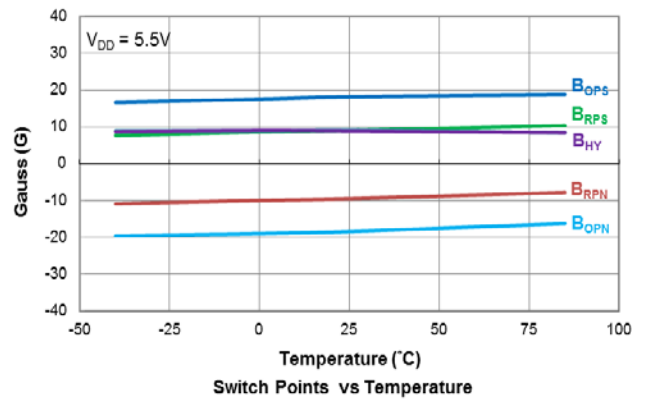
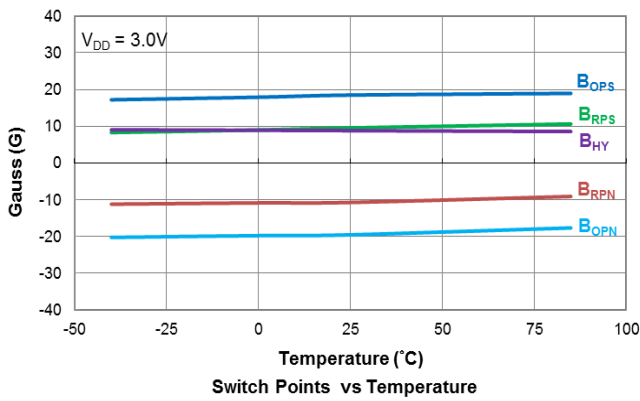
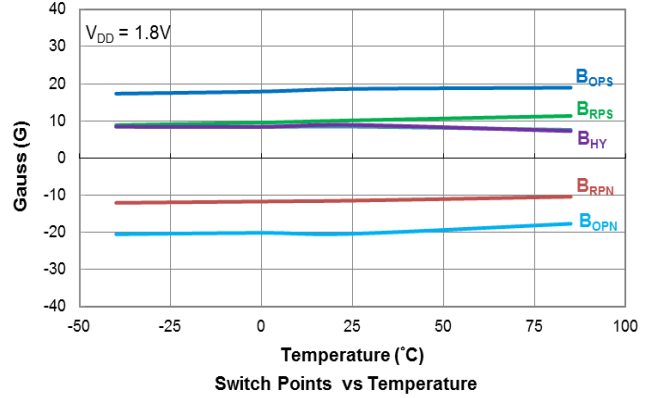
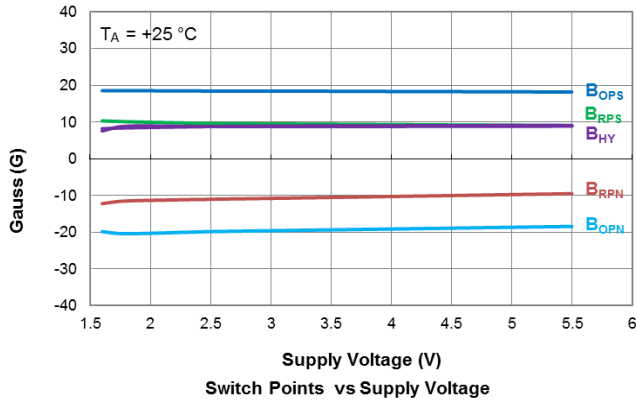

Average Supply Current

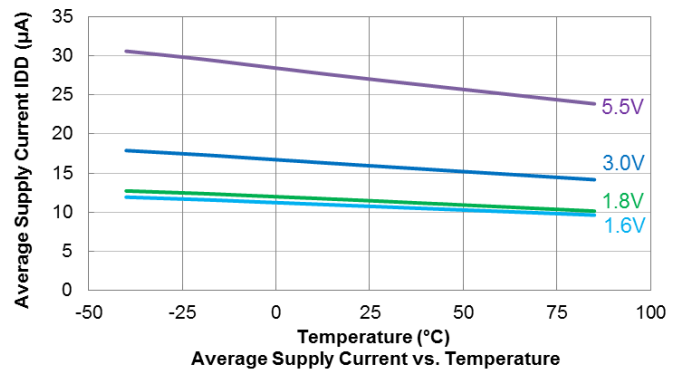
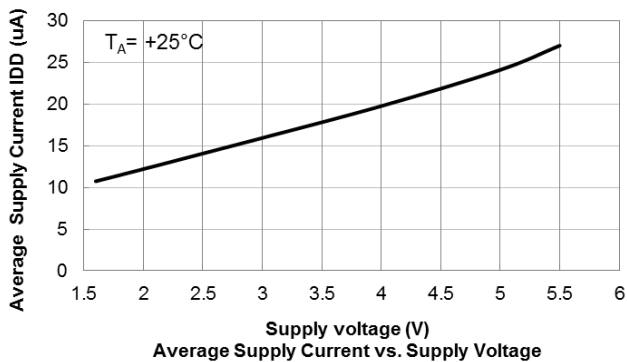

Ordering Information

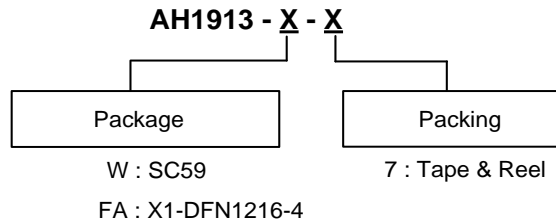

Part Number	Package Code	Packaging	7" Tape and Reel	
			Quantity	Part Number Suffix
AH1913-W-7	W	SC59	3000/Tape & Reel	-7
AH1913-FA-7	FA	X1-DFN1216-4	3000/Tape & Reel	-7

Marking Information

(1) Package Type: SC59

(Top View)

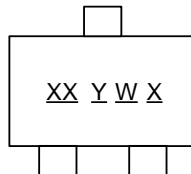

XX : Identification code
Y : Year 0 to 9
W : Week : A to Z : 1 to 26 week;
 a to z : 27 to 52 week; z represents
 52 and 53 week
X : Internal code

Part Number	Package	Identification Code
AH1913-W-7	SC59	KT

(2) Package Type: X1-DFN1216-4

(Top View)

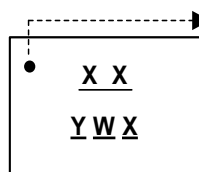

Pin 1 indicator
XX : Identification Code
Y : Year : 0~9
W : Week : A~Z : 1~26 week;
 a~z : 27~52 week; z represents
 52 and 53 week
X : Internal code

Part Number	Package	Identification Code
AH1913-FA-7	X1-DFN1216-4	KV

Package Outline Dimensions (All dimensions in mm.)

Please see <http://www.diodes.com/package-outlines.html> for the latest version.

(1) Package Type: SC59

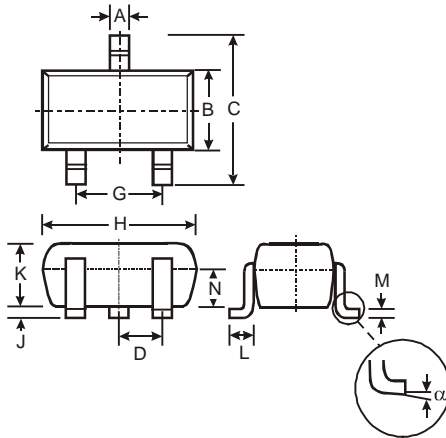

SC59			
Dim	Min	Max	Typ
A	0.35	0.50	0.38
B	1.50	1.70	1.60
C	2.70	3.00	2.80
D	-	-	0.95
G	-	-	1.90
H	2.90	3.10	3.00
J	0.013	0.10	0.05
K	1.00	1.30	1.10
L	0.35	0.55	0.40
M	0.10	0.20	0.15
N	0.70	0.80	0.75
α	0°	8°	-
All Dimensions in mm			

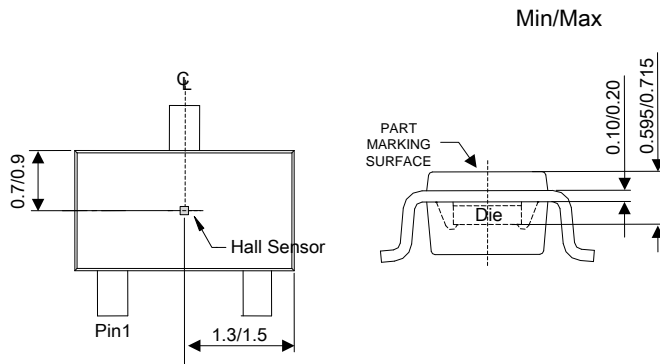

Sensor Location

Package Outline Dimensions (All dimensions in mm.)

Please see <http://www.diodes.com/package-outlines.html> for the latest version.

(2) Package Type: X1-DFN1216-4

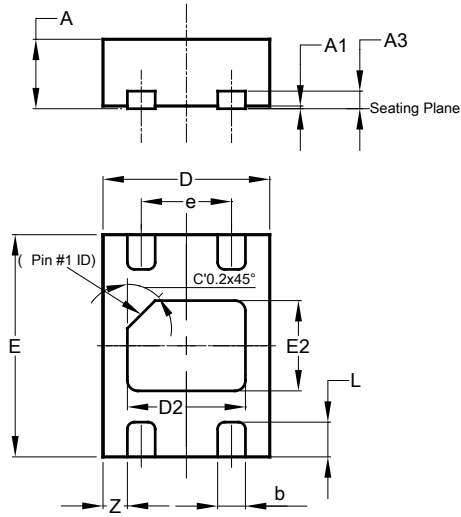

X1-DFN1216-4			
Dim	Min	Max	Typ
A	0.47	0.53	0.50
A1	0.00	0.05	0.02
A3	--	--	0.13
b	0.15	0.25	0.20
D	1.15	1.25	1.20
D2	0.75	0.95	0.85
E	1.55	1.65	1.60
E2	0.55	0.75	0.65
e	-	-	0.65
L	0.20	0.30	0.25
Z	-	-	0.175
All Dimensions in mm			

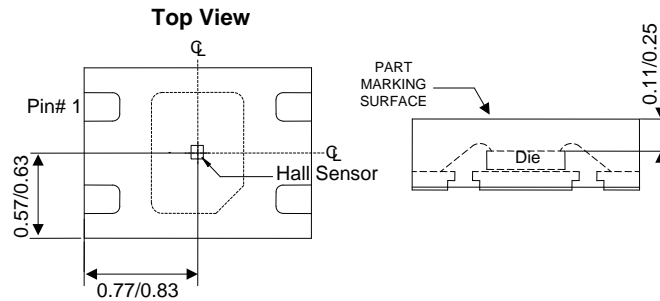

Sensor Location

Suggested Pad Layout

Please see <http://www.diodes.com/package-outlines.html> for the latest version.

(1) Package Type: SC59

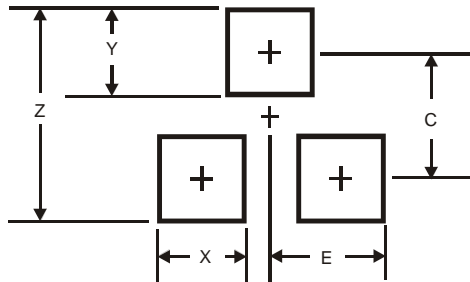

Dimensions	SC59
Z	3.4
X	0.8
Y	1.0
C	2.4
E	1.35

(2) Package Type: X1-DFN1216-4

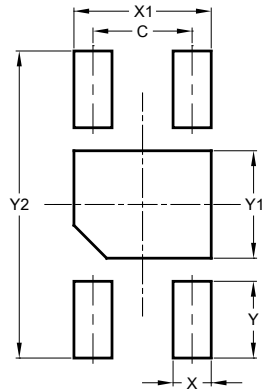

X1-DFN1216-4	
Dimensions	Value (in mm)
C	0.65
X	0.25
X1	0.90
Y	0.50
Y1	0.70
Y2	2.00

IMPORTANT NOTICE

DIODES INCORPORATED MAKES NO WARRANTY OF ANY KIND, EXPRESS OR IMPLIED, WITH REGARDS TO THIS DOCUMENT, INCLUDING, BUT NOT LIMITED TO, THE IMPLIED WARRANTIES OF MERCHANTABILITY AND FITNESS FOR A PARTICULAR PURPOSE (AND THEIR EQUIVALENTS UNDER THE LAWS OF ANY JURISDICTION).

Diodes Incorporated and its subsidiaries reserve the right to make modifications, enhancements, improvements, corrections or other changes without further notice to this document and any product described herein. Diodes Incorporated does not assume any liability arising out of the application or use of this document or any product described herein; neither does Diodes Incorporated convey any license under its patent or trademark rights, nor the rights of others. Any Customer or user of this document or products described herein in such applications shall assume all risks of such use and will agree to hold Diodes Incorporated and all the companies whose products are represented on Diodes Incorporated website, harmless against all damages.

Diodes Incorporated does not warrant or accept any liability whatsoever in respect of any products purchased through unauthorized sales channel. Should Customers purchase or use Diodes Incorporated products for any unintended or unauthorized application, Customers shall indemnify and hold Diodes Incorporated and its representatives harmless against all claims, damages, expenses, and attorney fees arising out of, directly or indirectly, any claim of personal injury or death associated with such unintended or unauthorized application.

Products described herein may be covered by one or more United States, international or foreign patents pending. Product names and markings noted herein may also be covered by one or more United States, international or foreign trademarks.

This document is written in English but may be translated into multiple languages for reference. Only the English version of this document is the final and determinative format released by Diodes Incorporated.

LIFE SUPPORT

Diodes Incorporated products are specifically not authorized for use as critical components in life support devices or systems without the express written approval of the Chief Executive Officer of Diodes Incorporated. As used herein:

A. Life support devices or systems are devices or systems which:

1. are intended to implant into the body, or
2. support or sustain life and whose failure to perform when properly used in accordance with instructions for use provided in the labeling can be reasonably expected to result in significant injury to the user.

B. A critical component is any component in a life support device or system whose failure to perform can be reasonably expected to cause the failure of the life support device or to affect its safety or effectiveness.



Customers represent that they have all necessary expertise in the safety and regulatory ramifications of their life support devices or systems, and acknowledge and agree that they are solely responsible for all legal, regulatory and safety-related requirements concerning their products and any use of Diodes Incorporated products in such safety-critical, life support devices or systems, notwithstanding any devices- or systems-related information or support that may be provided by Diodes Incorporated. Further, Customers must fully indemnify Diodes Incorporated and its representatives against any damages arising out of the use of Diodes Incorporated products in such safety-critical, life support devices or systems.

Copyright © 2019, Diodes Incorporated

www.diodes.com

Looking for pricing, stock, or lifecycle information?

Click below to explore more details on WIN SOURCE:

-  [View AH1913-W-7 on WIN SOURCE](#)
-  [Diodes Incorporated Information](#)

Optimize Your Supply Chain with WIN SOURCE Solutions

-  Global Sourcing Solution
-  Obsolete Management
-  Cost Control Management
-  Shortage Management
-  Alternative Solution
-  Excess Inventory Management