

NCP720

350mA, Very Low Dropout Bias Rail CMOS Voltage Regulator

The NCP720 is a 350 mA VLDO equipped with NMOS pass transistor and a separate bias supply voltage (V_{BIAS}). The device provides very stable, accurate output voltage with low noise suitable for space constrained, noise sensitive applications. In order to optimize performance for battery operated portable applications, the NCP720 features low I_Q consumption. The WDFN6 2 mm x 2 mm package is optimized for use in space constrained applications.

Features

- Input Voltage Range: 0.8 V to 5.5 V
- Bias Voltage Range: 2.4 V to 5.5 V
- Fixed Output Voltage Device
- Output Voltage Range: 0.8 V to 2.1 V
- $\pm 2\%$ Accuracy over Temperature
- Ultra-Low Dropout: 110 mV typically at 350 mA
- Very Low Bias Input Current of Typ. 80 μ A
- Very Low Bias Input Current in Disable Mode: Typ. 0.5 μ A
- Low Noise, High PSRR
- Built-In Soft-Start with Monotonic V_{OUT} Rise
- Stable with a 2.2 μ F Ceramic Capacitor
- Available in WDFN6 – 2 mm x 2 mm Package
- These are Pb-Free Devices

Typical Applications

- Battery-powered Equipment
- Smartphones, Tablets
- Cameras, DVRs, STB and Camcorders

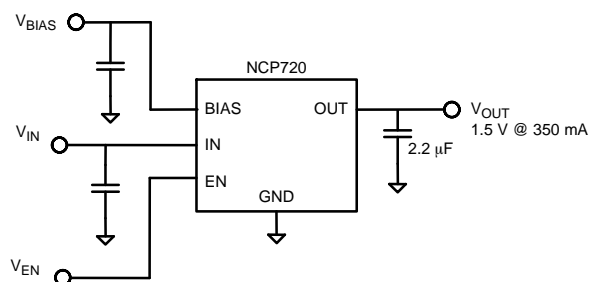

Figure 1. Typical Application Schematics



ON Semiconductor™

www.onsemi.com

MARKING DIAGRAM



WDFN6
CASE 511BR



XX = Specific Device Code
M = Date Code

PIN CONNECTIONS

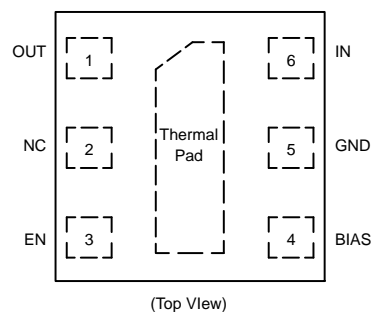

(Top View)

ORDERING INFORMATION

See detailed ordering, marking and shipping information on page 8 of this data sheet.

NCP720

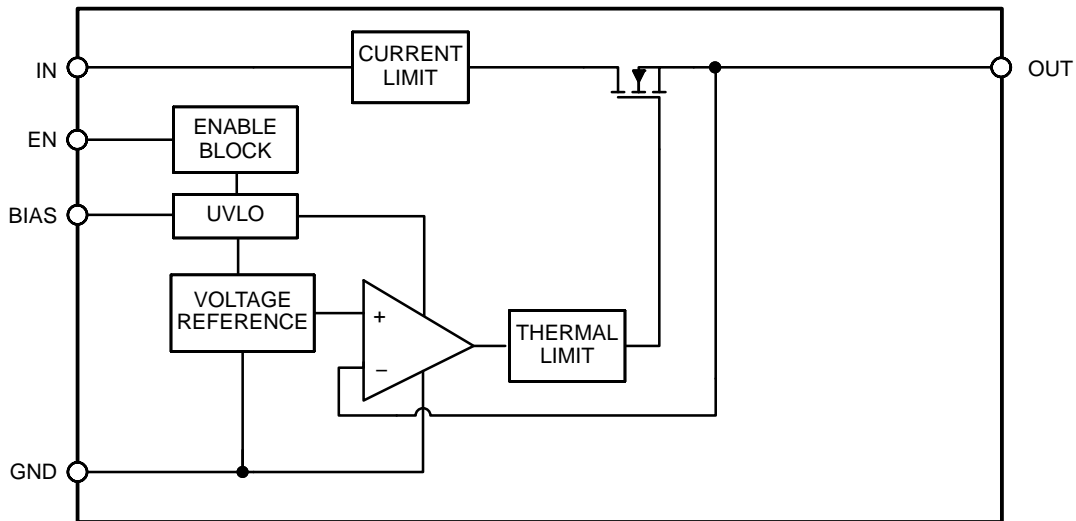

Figure 2. Simplified Schematic Block Diagram

PIN FUNCTION DESCRIPTION

Pin No.	Pin Name	Description
1	OUT	Regulated Output Voltage pin
2	N/C	Not internally connected
3	EN	Enable pin. Driving this pin high enables the regulator. Driving this pin low puts the regulator into shutdown mode.
4	BIAS	Bias voltage supply for internal control circuits. This pin is monitored by internal Under-Voltage Lockout Circuit.
5	GND	Ground pin
6	IN	Input Voltage Supply pin
Pad		Should be soldered to the ground plane for increased thermal performance.

ABSOLUTE MAXIMUM RATINGS

Rating	Symbol	Value	Unit
Input Voltage (Note 1)	V_{IN}	-0.3 to 6	V
Output Voltage	V_{OUT}	-0.3 to $(V_{IN}+0.3) \leq 6$	V
Chip Enable and Bias Input	V_{EN}, V_{BIAS}	-0.3 to 6	V
Output Short Circuit Duration	t_{SC}	unlimited	s
Maximum Junction Temperature	T_J	150	°C
Storage Temperature	T_{STG}	-55 to 150	°C
ESD Capability, Human Body Model (Note 2)	ESD_{HBM}	2000	V
ESD Capability, Machine Model (Note 2)	ESD_{MM}	200	V

Stresses exceeding those listed in the Maximum Ratings table may damage the device. If any of these limits are exceeded, device functionality should not be assumed, damage may occur and reliability may be affected.

1. Refer to ELECTRICAL CHARACTERISTICS and APPLICATION INFORMATION for Safe Operating Area.
2. This device series incorporates ESD protection (except OUT pin) and is tested by the following methods:
 ESD Human Body Model tested per EIA/JESD22-A114
 ESD Machine Model tested per EIA/JESD22-A115
 Latchup Current Maximum Rating tested per JEDEC standard: JESD78.

THERMAL CHARACTERISTICS

Rating	Symbol	Value	Unit
Thermal Characteristics, WDFN6 2 mm x 2 mm Thermal Resistance, Junction-to-Air (Note 3)	$R_{\theta JA}$	65	°C/W

3. This data was derived by thermal simulations based on the JEDEC JESD51 series standards methodology. Only a single device mounted at the center of a high-K (2s2p) 3in x 3in multilayer board with 1-ounce internal planes and 2-ounce copper on top and bottom. Top copper layer has a dedicated 125 sqmm copper area.

NCP720

ELECTRICAL CHARACTERISTICS

Over Operating Temperature Range ($T_J = -40^\circ\text{C}$ to $+125^\circ\text{C}$), $V_{BIAS} = (V_{OUT} + 1.4\text{ V})$ or 2.5 V , whichever is greater; $V_{IN} \geq V_{OUT} + 0.5\text{ V}$, $I_{OUT} = 1\text{ mA}$, $V_{EN} = 1.1\text{ V}$, $C_{OUT} = 2.2\text{ }\mu\text{F}$, unless otherwise noted. Typical values are at $T_J = +25^\circ\text{C}$.

Parameter		Test Conditions	Symbol	Min	Typ	Max	Unit
Operating Input Voltage Range			V_{IN}	$V_{OUT} + V_{DO_IN}$		5.5	V
Operating Bias Voltage Range			V_{BIAS}	$(V_{OUT} + 1.4) \geq 2.4$		5.5	V
Output Voltage Range (Note 4)				0.8		2.1	V
Output Voltage Accuracy	Nominal	$T_J = +25^\circ\text{C}$	V_{OUT}		± 0.5		%
	Over V_{BIAS} , V_{IN} , I_{OUT} , $T_J = -40^\circ\text{C}$ to $+125^\circ\text{C}$	$V_{OUT} + 1.4\text{ V} \leq V_{BIAS} \leq 5.5\text{ V}$, $V_{OUT} + 0.5\text{ V} \leq V_{IN} \leq 4.5\text{ V}$, $0\text{ mA} \leq I_{OUT} \leq 350\text{ mA}$	V_{OUT}	-2		+2	%
V_{IN} Line Regulation		$V_{IN} = (V_{OUT} + 0.5\text{ V})$ to 4.5 V , $I_{OUT} = 1\text{ mA}$	$\Delta V_{OUT}/\Delta V_{IN}$		5.0		$\mu\text{V}/\text{V}$
V_{BIAS} Line Regulation		$V_{BIAS} = (V_{OUT} + 1.4\text{ V})$ or 2.5 V (whichever is greater) to 5.5 V , $I_{OUT} = 1\text{ mA}$	$\Delta V_{OUT}/\Delta V_{BIAS}$		16		$\mu\text{V}/\text{V}$
Load Regulation		$0\text{ mA} \leq I_{OUT} \leq 350\text{ mA}$ (no load to full load)	$\Delta V_{OUT}/\Delta I_{OUT}$		-1.0		$\mu\text{V}/\text{mA}$
V_{IN} Dropout Voltage (Note 5)		$V_{IN} = V_{OUT(NOM)} - 0.1\text{ V}$, $(V_{BIAS} - V_{OUT(NOM)}) = 1.4\text{ V}$, $I_{OUT} = 350\text{ mA}$	V_{DO_IN}		110	200	mV
V_{BIAS} Dropout Voltage (Note 6)		$V_{IN} = V_{OUT(NOM)} + 0.3\text{ V}$, $I_{OUT} = 350\text{ mA}$	V_{DO_BIAS}		1.15	1.4	V
Output Current Limit		$V_{OUT} = 0.9 \times V_{OUT(NOM)}$	I_{CL}	420	525	800	mA
Bias Pin Current		$I_{OUT} = 0\text{ mA}$ to 350 mA	I_{BIAS}		80	110	μA
Shutdown Current (I_{GND})		$V_{EN} \leq 0.4\text{ V}$, $T_J = -40^\circ\text{C}$ to $+85^\circ\text{C}$	I_{SHDN}		0.5	2.0	μA
V_{IN} Power-Supply Rejection Ratio	$V_{IN} - V_{OUT} \geq 0.5\text{ V}$, $V_{BIAS} = V_{OUT} + 1.4\text{ V}$, $I_{OUT} = 350\text{ mA}$	$f = 10\text{ Hz}$	PSRR (V_{IN})		52		dB
		$f = 100\text{ Hz}$			56		
		$f = 1\text{ kHz}$			65		
		$f = 10\text{ kHz}$			46		
		$f = 100\text{ kHz}$			37		
		$f = 1\text{ MHz}$			25		
V_{BIAS} Power-Supply Rejection Ratio	$V_{IN} - V_{OUT} \geq 0.5\text{ V}$, $V_{BIAS} = V_{OUT} + 1.4\text{ V}$, $I_{OUT} = 350\text{ mA}$	$f = 10\text{ Hz}$	PSRR (V_{BIAS})		65		dB
		$f = 100\text{ Hz}$			65		
		$f = 1\text{ kHz}$			70		
		$f = 10\text{ kHz}$			50		
		$f = 100\text{ kHz}$			35		
		$f = 1\text{ MHz}$			24		
Output Noise Voltage		$BW = 10\text{ Hz}$ to 100 kHz	V_N		40		μV_{RMS}
Inrush Current on V_{IN}			I_{VIN_INRUSH}		$100 + I_{LOAD}$		mA
Startup Time		$V_{OUT} = 95\% V_{OUT(NOM)}$, $I_{OUT} = 350\text{ mA}$, $C_{OUT} = 2.2\text{ }\mu\text{F}$	t_{STR}		140		μs
Enable Pin High (enabled)			$V_{EN(HI)}$	1.1			V
Enable Pin Low (disabled)			$V_{EN(LO)}$	0		0.4	V
Enable Pin Current		$V_{EN} = 5.5\text{ V}$	I_{EN}		0.3	1	μA
Undervoltage Lock-out		V_{BIAS} rising	UVLO		1.6		V
Hysteresis		V_{BIAS} falling			0.2		V
Thermal Shutdown Temperature		Shutdown, temperature increasing	T_{SD}		+160		$^\circ\text{C}$
		Reset, temperature decreasing			+140		$^\circ\text{C}$
Operating Junction Temperature			T_J	-40		+125	$^\circ\text{C}$

Product parametric performance is indicated in the Electrical Characteristics for the listed test conditions, unless otherwise noted. Product performance may not be indicated by the Electrical Characteristics if operated under different conditions.

4. V_{OUT} nominal value is factory programmable.
5. Measured for devices with $V_{OUT(NOM)} \geq 1.2\text{ V}$.
6. $V_{BIAS} - V_{OUT}$ with $V_{OUT} = V_{OUT(NOM)} - 0.1\text{ V}$.

NCP720

APPLICATIONS INFORMATION

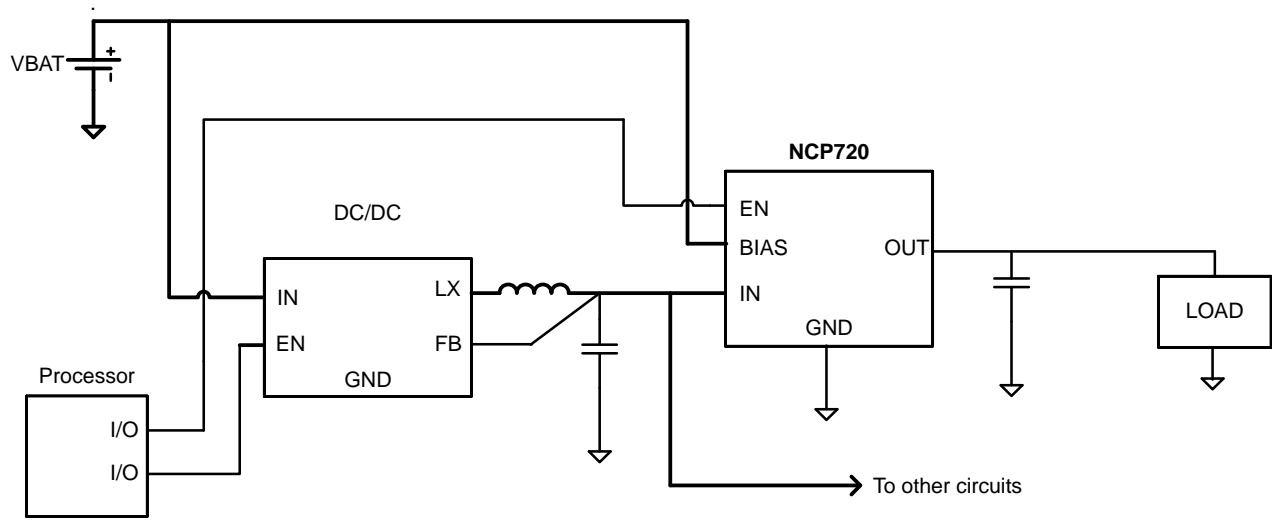

Figure 3. Typical Application: Low-Voltage Post-Regulator with ON/OFF functionality

NCP720

TYPICAL CHARACTERISTICS

$V_{OUT(NOMINAL)} = 1.5\text{ V}$, $V_{BIAS} = (V_{OUT} + 1.4\text{ V})$ or 2.5 V , whichever is greater, $V_{IN} = V_{OUT} + 0.5\text{ V}$, $I_{OUT} = 1\text{ mA}$,
 $V_{EN} = 1.1\text{ V}$, $C_{OUT} = 2.2\text{ }\mu\text{F}$, $T_J = 25^\circ\text{C}$ unless otherwise noted.

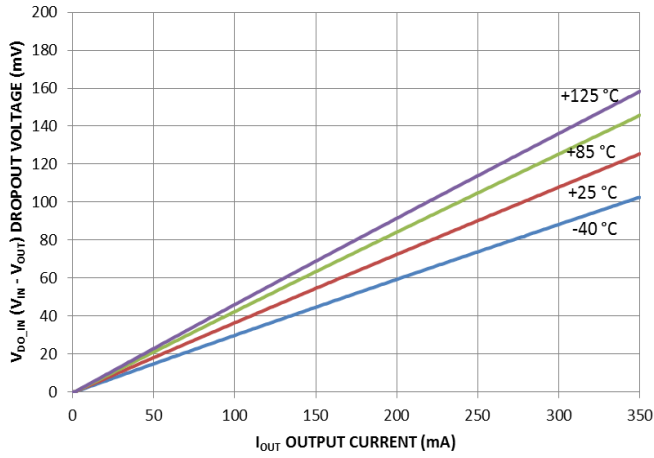

Figure 4. V_{IN} Dropout Voltage vs. Output Current

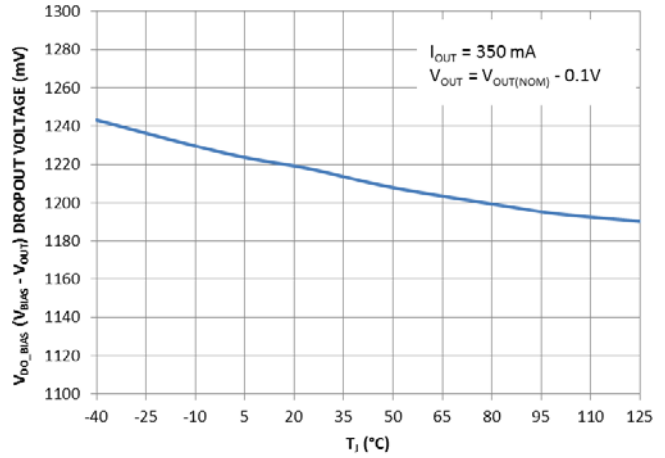

Figure 5. V_{BIAS} Dropout Voltage vs. Temperature

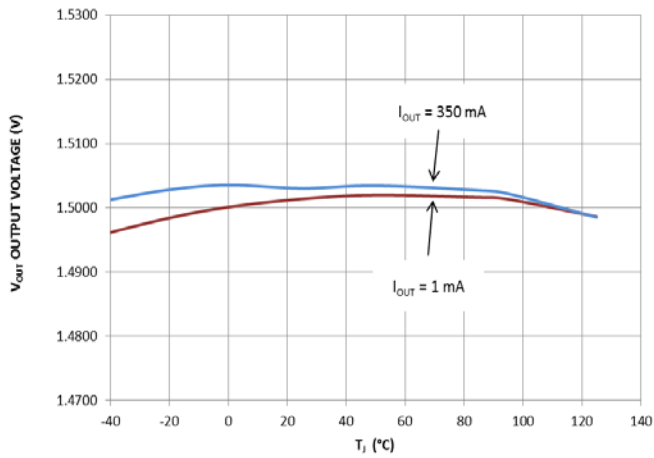

Figure 6. Output Voltage vs. Temperature

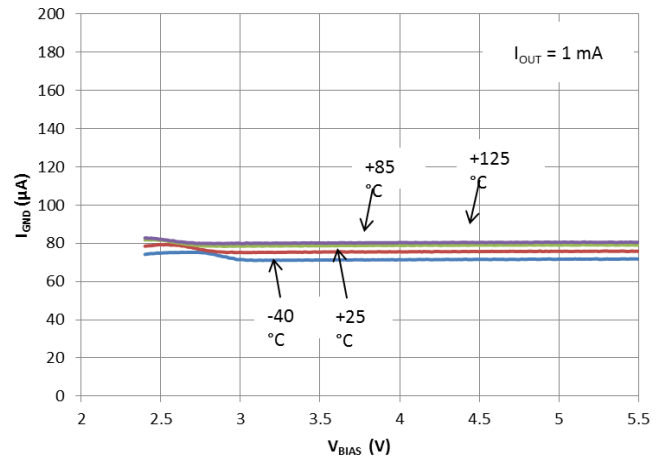

Figure 7. Bias Pin Current vs. V_{BIAS} Input Voltage

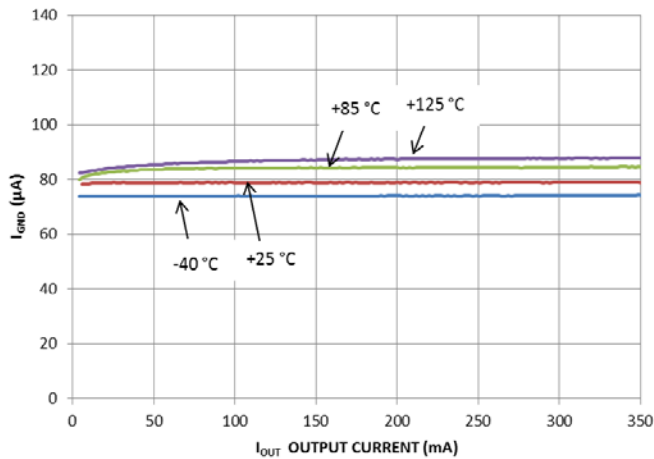

Figure 8. Bias Pin Current vs. Output Current

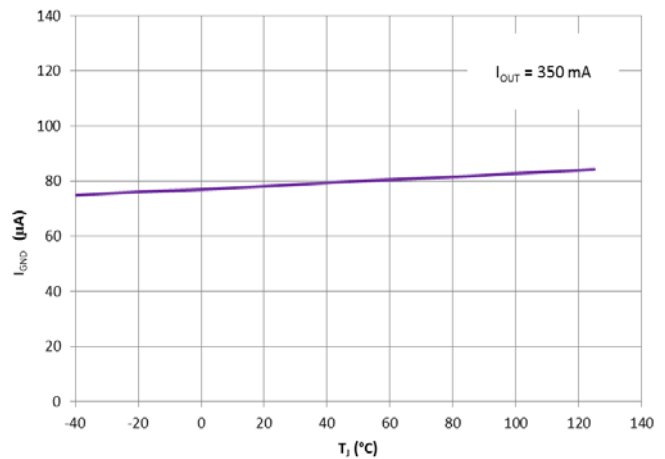

Figure 9. Bias Pin Current vs. Temperature

NCP720

TYPICAL CHARACTERISTICS

$V_{OUT(NOMINAL)} = 1.5\text{ V}$, $V_{BIAS} = (V_{OUT} + 1.4\text{ V})$ or 2.5 V , whichever is greater, $V_{IN} = V_{OUT} + 0.5\text{ V}$, $I_{OUT} = 1\text{ mA}$,
 $V_{EN} = 1.1\text{ V}$, $C_{OUT} = 2.2\text{ }\mu\text{F}$, $T_J = 25^\circ\text{C}$ unless otherwise noted.

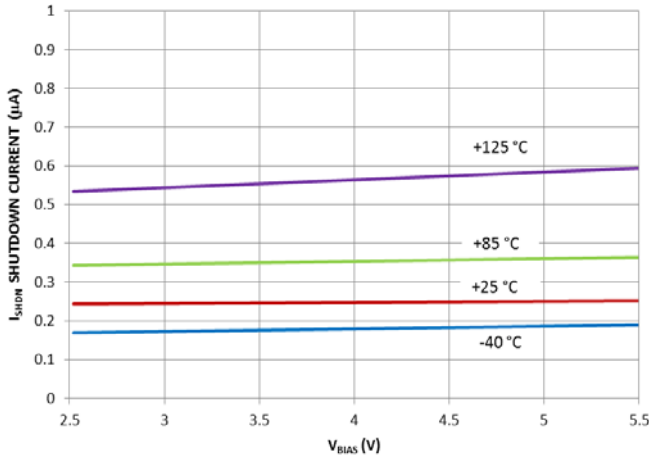

Figure 10. Shutdown Current vs. V_{BIAS} Input Voltage

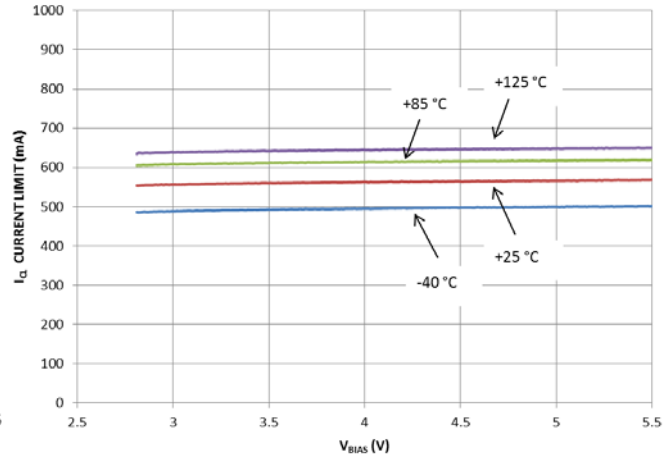

Figure 11. Current Limit vs. V_{BIAS} Input Voltage

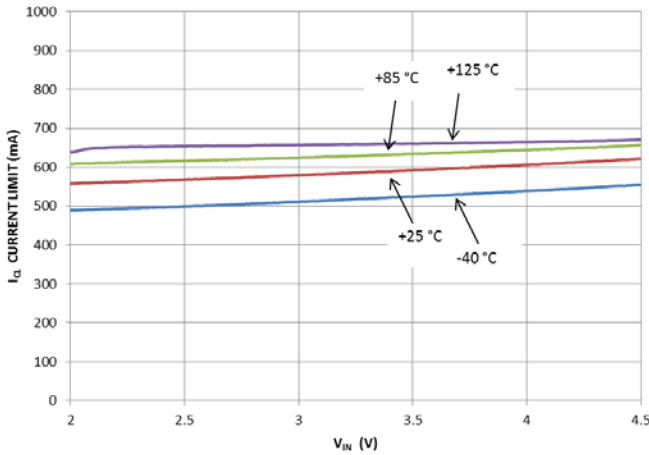

Figure 12. Current Limit vs. V_{IN} Input Voltage

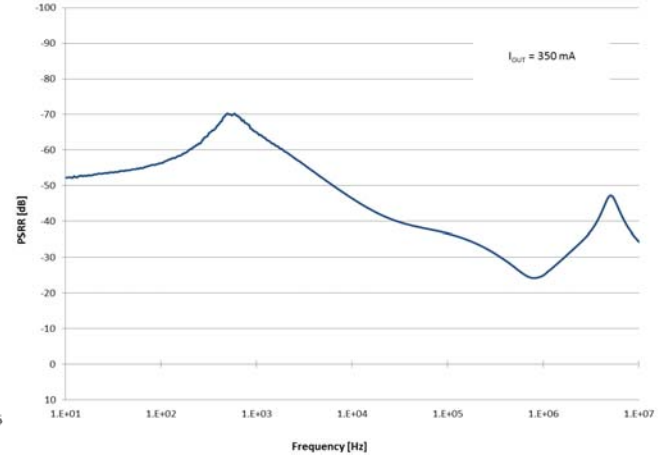

Figure 13. V_{IN} Power Supply Ripple Rejection vs. Frequency

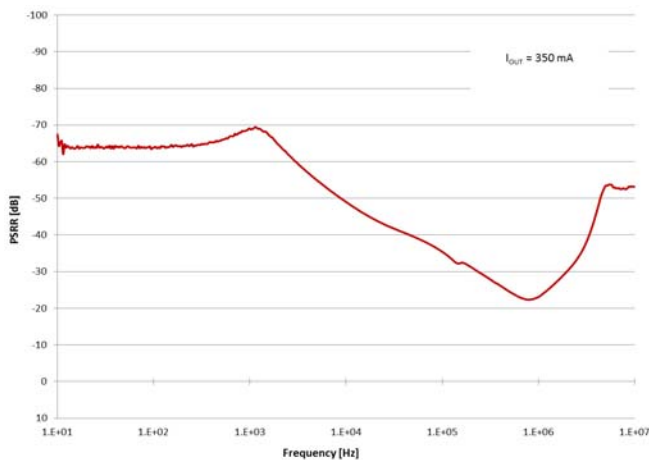

Figure 14. V_{BIAS} Power Supply Ripple Rejection vs. Frequency

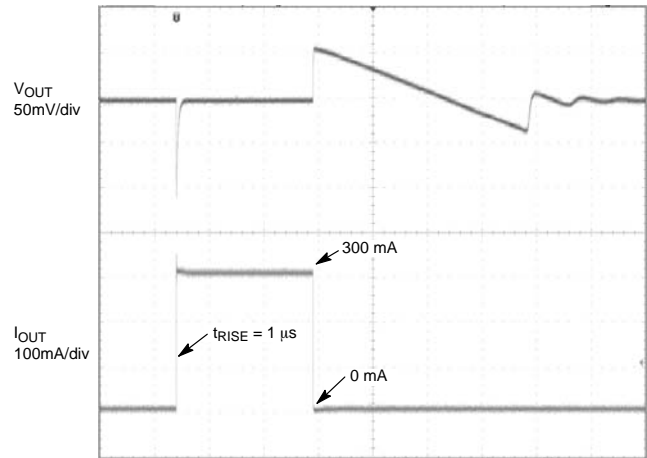

Figure 15. Load Transient Response

APPLICATIONS INFORMATION

The NCP720 dual-rail very low dropout voltage regulator is using NMOS pass transistor for output voltage regulation from V_{IN} voltage. All the low current internal control circuitry is powered from the V_{BIAS} voltage.

The use of an NMOS pass transistor offers several advantages in applications. Unlike a PMOS topology devices, the output capacitor has reduced impact on loop stability. V_{IN} to V_{OUT} operating voltage difference can be very low compared with standard PMOS regulators in very low V_{IN} applications.

The NCP720 offers built-in Soft-Start with monotonic V_{OUT} rise. The controlled voltage rising limits the inrush current.

The Enable (EN) input is equipped with internal hysteresis.

NCP720 is a Fixed Voltage linear regulator.

Dropout Voltage

Because of two power supply inputs V_{IN} and V_{BIAS} and one V_{OUT} regulator output, there are two Dropout voltages specified.

The first, the V_{IN} Dropout voltage is the voltage difference ($V_{IN} - V_{OUT}$) at which the regulator output no longer maintains regulation against further reductions in input voltage. V_{BIAS} is high enough, specific value is published in the Electrical Characteristics table.

The second, V_{BIAS} dropout voltage is the voltage difference ($V_{BIAS} - V_{OUT}$) at which the regulator output no longer maintains regulation against further reductions in V_{BIAS} voltage. V_{IN} is high enough.

Input and Output Capacitors

The device is designed to be stable for ceramic output capacitors with Effective capacitance in the range from 2.2 μF to 10 μF . The device is also stable with multiple capacitors in parallel, having the total effective capacitance in the specified range.

In applications where no low input supplies impedance available (PCB inductance in V_{IN} and/or V_{BIAS} inputs as

example), the recommended $C_{IN} = 1 \mu\text{F}$ and $C_{BIAS} = 0.1 \mu\text{F}$ or greater. Ceramic capacitors are recommended. For the best performance all the capacitors should be connected to the NCP720 respective pins directly in the device PCB copper layer, not through vias having not negligible impedance.

When using small ceramic capacitor, their capacitance is not constant but varies with applied DC biasing voltage, temperature and tolerance. The effective capacitance can be much lower than their nominal capacitance value, most importantly in negative temperatures and higher LDO output voltages. That is why the recommended Output capacitor capacitance value is specified as Effective value in the specific application conditions.

Enable Operation

The enable pin will turn the regulator on or off. The threshold limits are covered in the electrical characteristics table in this data sheet. If the enable function is not to be used then the pin should be connected to V_{IN} or V_{BIAS} . When enabled, the device consumes roughly 20 μA from V_{IN} supply per 1 V nominal output voltage. That is why using the enable / disable function in power saving applications is recommended.

Current Limitation

The internal Current Limitation circuitry allows the device to supply the full nominal current and surges but protects the device against Current Overload or Short.

Thermal Protection

Internal thermal shutdown (TSD) circuitry is provided to protect the integrated circuit in the event that the maximum junction temperature is exceeded. When TSD activated, the regulator output turns off. When cooling down under the low temperature threshold, device output is activated again. This TSD feature is provided to prevent failures from accidental overheating.

NCP720

ORDERING INFORMATION

Device	Nominal Output Voltage	Marking	Package	Shipping [†]
NCP720BMT100TBG	1.00 V	JC	WDFN6 (Pb-Free)	3000 / Tape & Reel
NCP720BMT105TBG	1.05 V	JD		
NCP720BMT110TBG	1.10 V	JE		
NCP720BMT115TBG	1.15 V	JF		
NCP720BMT120TBG	1.20 V	JG		
NCP720BMT125TBG	1.25 V	JH		
NCP720BMT130TBG	1.30 V	JJ		
NCP720BMT135TBG	1.35 V	JK		
NCP720BMT140TBG	1.40 V	JL		
NCP720BMT145TBG	1.45 V	JM		
NCP720BMT150TBG	1.50 V	JA		
NCP720BMT160TBG	1.60 V	JP		
NCP720BMT170TBG	1.70 V	JQ		
NCP720BMT180TBG	1.80 V	JR		

[†]For information on tape and reel specifications, including part orientation and tape sizes, please refer to our Tape and Reel Packaging Specifications Brochure, BRD8011/D.

To order other package and voltage variants, please contact your ON sales representative

MECHANICAL CASE OUTLINE PACKAGE DIMENSIONS



WDFN6 2x2, 0.65P
CASE 511BR
ISSUE C

DATE 01 DEC 2021

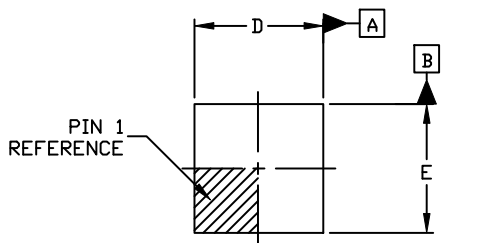

TOP VIEW

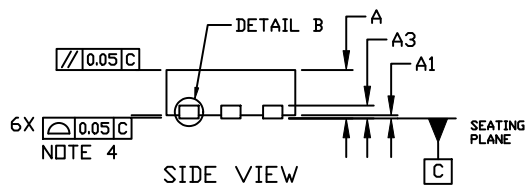

SIDE VIEW

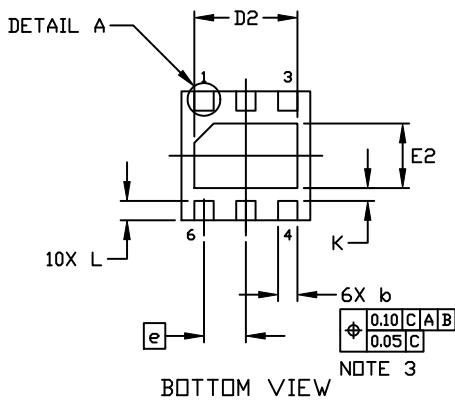

BOTTOM VIEW

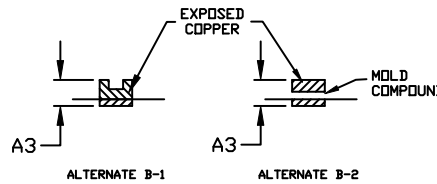

DETAIL B
ALTERNATE CONSTRUCTION

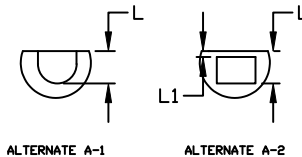

DETAIL A
ALTERNATE CONSTRUCTIONS

DIM	MILLIMETERS		
	MIN.	NDM.	MAX.
A	0.70	0.75	0.80
A1	0.00	---	0.05
A3	0.20 REF		
b	0.25	0.30	0.35
D	1.90	2.00	2.10
D2	1.50	1.60	1.70
E	1.90	2.00	2.10
E2	0.90	1.00	1.10
e	0.65 BSC		
K	0.20 REF		
L	0.20	0.30	0.40
L1	---	---	0.15

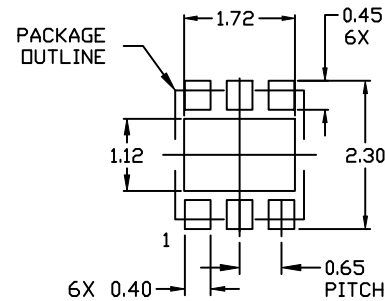

RECOMMENDED
MOUNTING FOOTPRINT

For additional information on our Pb-Free strategy and soldering details, please download the ON Semiconductor Soldering and Mounting Techniques Reference Manual, SOLDERM/D.

GENERIC MARKING DIAGRAM*



XX = Specific Device Code
M = Date Code

This information is generic. Please refer to device data sheet for actual part marking. Pb-Free indicator, "G" or microdot "", may or may not be present. Some products may not follow the Generic Marking.

DOCUMENT NUMBER:	98AON55829E	Electronic versions are uncontrolled except when accessed directly from the Document Repository. Printed versions are uncontrolled except when stamped "CONTROLLED COPY" in red.
DESCRIPTION:	WDFN6 2X2, 0.65P	PAGE 1 OF 1

onsemi and ONSEMI are trademarks of Semiconductor Components Industries, LLC dba onsemi or its subsidiaries in the United States and/or other countries. onsemi reserves the right to make changes without further notice to any products herein. onsemi makes no warranty, representation or guarantee regarding the suitability of its products for any particular purpose, nor does onsemi assume any liability arising out of the application or use of any product or circuit, and specifically disclaims any and all liability, including without limitation special, consequential or incidental damages. onsemi does not convey any license under its patent rights nor the rights of others.

onsemi, **Onsemi**, and other names, marks, and brands are registered and/or common law trademarks of Semiconductor Components Industries, LLC dba "**onsemi**" or its affiliates and/or subsidiaries in the United States and/or other countries. **onsemi** owns the rights to a number of patents, trademarks, copyrights, trade secrets, and other intellectual property. A listing of **onsemi**'s product/patent coverage may be accessed at www.onsemi.com/site/pdf/Patent-Marking.pdf. **onsemi** reserves the right to make changes at any time to any products or information herein, without notice. The information herein is provided "as-is" and **onsemi** makes no warranty, representation or guarantee regarding the accuracy of the information, product features, availability, functionality, or suitability of its products for any particular purpose, nor does **onsemi** assume any liability arising out of the application or use of any product or circuit, and specifically disclaims any and all liability, including without limitation special, consequential or incidental damages. Buyer is responsible for its products and applications using **onsemi** products, including compliance with all laws, regulations and safety requirements or standards, regardless of any support or applications information provided by **onsemi**. "Typical" parameters which may be provided in **onsemi** data sheets and/or specifications can and do vary in different applications and actual performance may vary over time. All operating parameters, including "Typicals" must be validated for each customer application by customer's technical experts. **onsemi** does not convey any license under any of its intellectual property rights nor the rights of others. **onsemi** products are not designed, intended, or authorized for use as a critical component in life support systems or any FDA Class 3 medical devices or medical devices with a same or similar classification in a foreign jurisdiction or any devices intended for implantation in the human body. Should Buyer purchase or use **onsemi** products for any such unintended or unauthorized application, Buyer shall indemnify and hold **onsemi** and its officers, employees, subsidiaries, affiliates, and distributors harmless against all claims, costs, damages, and expenses, and reasonable attorney fees arising out of, directly or indirectly, any claim of personal injury or death associated with such unintended or unauthorized use, even if such claim alleges that **onsemi** was negligent regarding the design or manufacture of the part. **onsemi** is an Equal Opportunity/Affirmative Action Employer. This literature is subject to all applicable copyright laws and is not for resale in any manner.

ADDITIONAL INFORMATION

TECHNICAL PUBLICATIONS:

Technical Library: www.onsemi.com/design/resources/technical-documentation
onsemi Website: www.onsemi.com

ONLINE SUPPORT: www.onsemi.com/support

For additional information, please contact your local Sales Representative at www.onsemi.com/support/sales

Looking for pricing, stock, or lifecycle information?

Click below to explore more details on WIN SOURCE:

 [View NCP720BMT125TBG on WIN SOURCE](#)

 [ON Semiconductor](#) Information

Optimize Your Supply Chain with WIN SOURCE Solutions

-  Global Sourcing Solution
-  Obsolete Management
-  Cost Control Management
-  Shortage Management
-  Alternative Solution
-  Excess Inventory Management