



**THE DATASHEET OF
NCP3335ADM500R2G**



NCP3335A

Low Dropout Regulator - Ultra High Accuracy, Low Iq

500 mA

The NCP3335A is a high performance, low dropout regulator with accuracy of $\pm 0.9\%$ over line and load. This device features ultra-low quiescent current and noise which encompasses all necessary characteristics demanded by today's consumer electronics. This unique device is guaranteed to be stable without a minimum load current requirement and stable with any type of capacitor as small as 1.0 μF . The NCP3335A also comes equipped with sense and noise reduction pins to increase the overall utility of the device and offers reverse bias protection.

Features

- High Accuracy Over Line and Load ($\pm 0.9\%$ at 25°C)
- Ultra-Low Dropout Voltage at Full Load (260 mV typ.)
- No Minimum Output Current Required for Stability
- Low Noise (31 μVrms w/10 nF C_{nr} and 51 μVrms w/out C_{nr})
- Low Shutdown Current (0.07 μA)
- Reverse Bias Protected
- 2.6 V to 12 V Supply Range
- Thermal Shutdown Protection
- Current Limitation
- Requires Only 1.0 μF Output Capacitance for Stability
- Stable with Any Type of Capacitor (including MLCC)
- Available in 1.5 V, 1.8 V, 2.5 V, 2.8 V, 2.85 V, 3.0 V, 3.3 V, 5.0 V and Adjustable Output Voltages
- These are Pb-Free Devices

Applications

- PCMCIA Card
- Cellular Phones
- Camcoders and Cameras
- Networking Systems, DSL/Cable Modems
- Cable Set-Top Box
- MP3/CD Players
- DSP Supply
- Displays and Monitors



ON Semiconductor®

<http://onsemi.com>



Micro8™
DM SUFFIX
CASE 846A



DFN10
MN SUFFIX
CASE 485C

MARKING DIAGRAMS

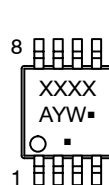

Fixed Version

Pin 1, 2. V_{out}
3. Sense
4. GND
5. NR
6. \overline{SD}
7, 8. V_{in}

Adj Version

Pin 1, 2. V_{out}
3. Adj
4. GND
5. NR
6. \overline{SD}
7, 8. V_{in}

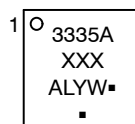

Fixed Version

Pin 1, 2. V_{out}
3. Sense
4. GND
5, 6. NC
7. NR
8. \overline{SD}
9, 10. V_{in}

Adj Version

Pin 1, 2. V_{out}
3. Adj
4. GND
5, 6. NC
7. NR
8. \overline{SD}
9, 10. V_{in}

XXX = Specific Device Marking

A = Assembly Location

L = Wafer Lot

Y = Year

W = Work Week

▪ = Pb-Free Package

(Note: Microdot may be in either location)

ORDERING INFORMATION

See detailed ordering, marking and shipping information in the package dimensions section on page 19 of this data sheet.

NCP3335A

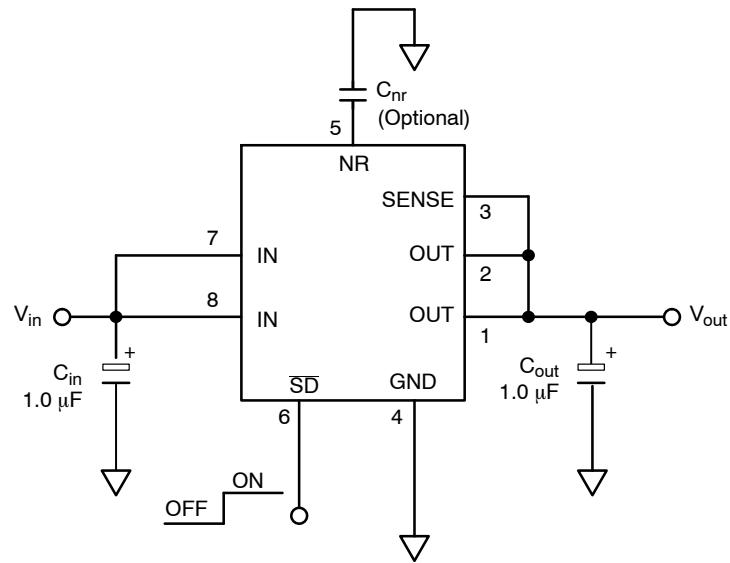

Figure 1. Typical Fixed Version Application Schematic (Micro8 Package)

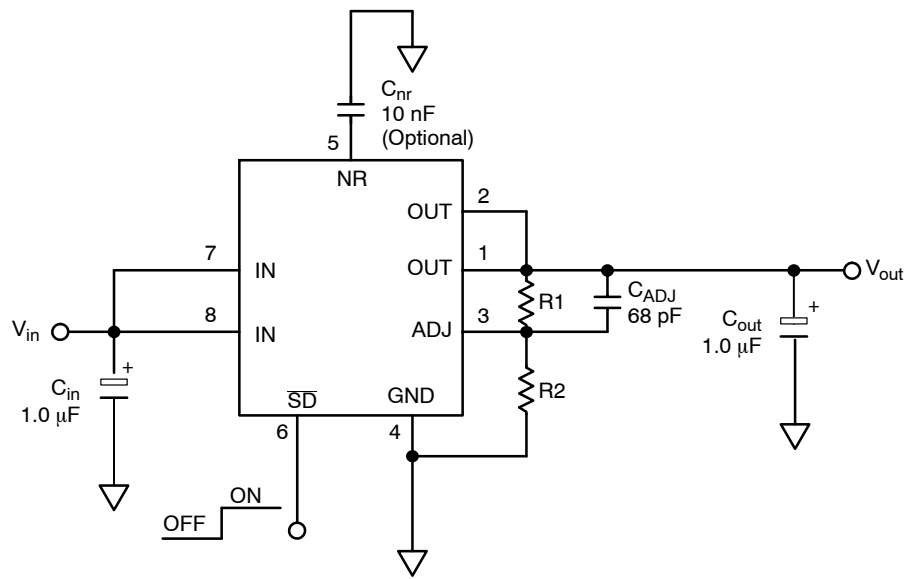

Figure 2. Typical Adjustable Version Application Schematic (Micro8 Package)

NCP3335A

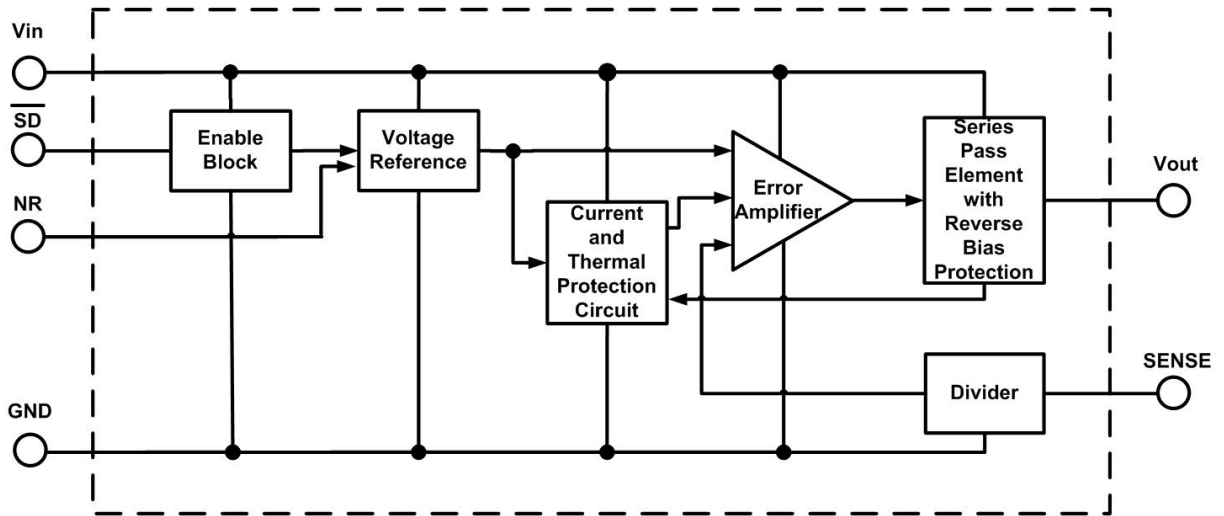

Figure 3. Block Diagram, Fixed Output Version

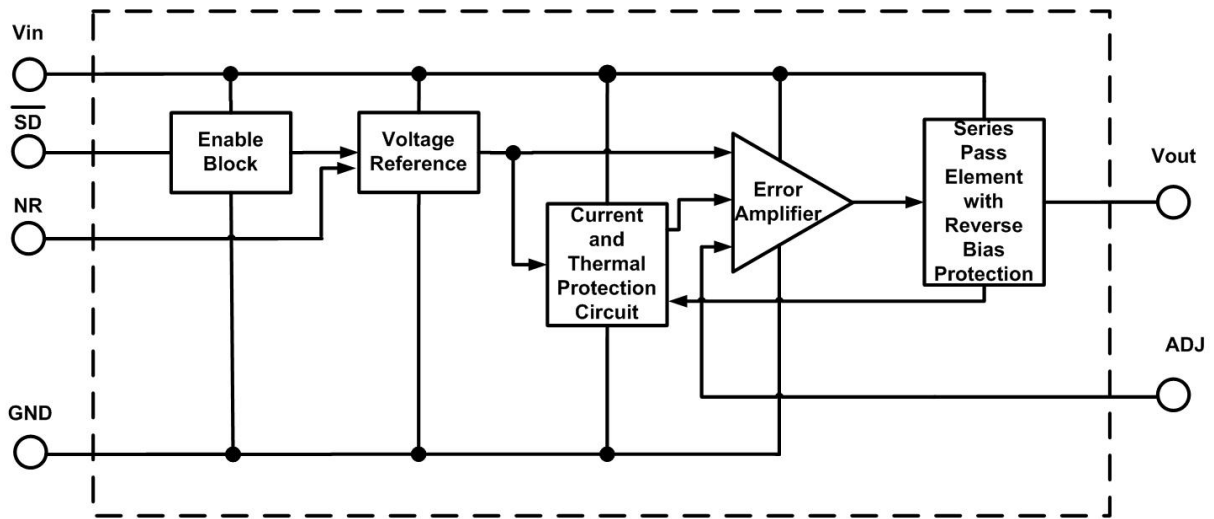

Figure 4. Block Diagram, Adjustable Output Version

NCP3335A

PIN FUNCTION DESCRIPTION

Fixed Version

| Micro8 Pin No. | DFN10 Pin No. | Pin Name | Description |
|----------------|---------------|------------------|---|
| 1, 2 | 1, 2 | V _{out} | Regulated output voltage. Bypass to ground with C _{out} ≥ 1.0 μF. |
| 3 | 3 | SENSE | For output voltage sensing, connect to Pins 1 and 2. |
| 4 | 4 | GND | Power Supply Ground |
| 5 | 7 | NR | Noise Reduction Pin. This is an optional pin used to further reduce noise. |
| 6 | 8 | SD | Shutdown pin. When not in use, this pin should be connected to the input pin. |
| 7, 8 | 9, 10 | V _{in} | Power Supply Input Voltage |
| – | 5, 6 | NC | Not Connected |
| – | EPAD | EPAD | Exposed thermal pad should be connected to ground. |

Adjustable Version

| | | | |
|------|-------|------------------|---|
| 1, 2 | 1, 2 | V _{out} | Regulated output voltage. Bypass to ground with C _{out} ≥ 1.0 μF. |
| 3 | 3 | Adj | Adjustable pin; reference voltage = 1.25 V. |
| 4 | 4 | GND | Power Supply Ground |
| 5 | 7 | NR | Noise Reduction Pin. This is an optional pin used to further reduce noise. |
| 6 | 8 | \overline{SD} | Shutdown pin. When not in use, this pin should be connected to the input pin. |
| 7, 8 | 9, 10 | V _{in} | Power Supply Input Voltage |
| – | 5, 6 | NC | Not Connected |
| – | EPAD | EPAD | Exposed thermal pad should be connected to ground. |

MAXIMUM RATINGS

| Rating | Symbol | Value | Unit |
|----------------------------|------------------|---------------------------------------|------|
| Input Voltage | V _{in} | –0.3 to +16 | V |
| Output Voltage | V _{out} | –0.3 to V _{in} +0.3 or 10 V* | V |
| Shutdown Pin Voltage | V _{sh} | –0.3 to +16 | V |
| Junction Temperature Range | T _J | –40 to +150 | °C |
| Storage Temperature Range | T _{stg} | –50 to +150 | °C |

Stresses exceeding Maximum Ratings may damage the device. Maximum Ratings are stress ratings only. Functional operation above the Recommended Operating Conditions is not implied. Extended exposure to stresses above the Recommended Operating Conditions may affect device reliability.

NOTE: This device series contains ESD protection and exceeds the following tests:

Human Body Model (HBM) JESD 22–A114–B

Machine Model (MM) JESD 22–A115–A

*Which ever is less. Reverse bias protection feature valid only if V_{out} – V_{in} ≤ 7 V.

THERMAL CHARACTERISTICS

| Characteristic | Test Conditions (Typical Value) | | Unit |
|-----------------------------------|---------------------------------|-----------------------|------|
| | Min Pad Board (Note 1) | 1" Pad Board (Note 1) | |
| Micro 8 | | | |
| Junction-to-Air, θ _{JA} | 264 | 174 | °C/W |
| Junction-to-Pin, ψ _{JL2} | 110 | 100 | °C/W |
| 10 Lead DFN EPad | | | |
| Junction-to-Air, θ _{JA} | 215 | 66 | °C/W |
| Junction-to-Pin, ψ _{JL2} | 55 | 17 | °C/W |

1. As mounted on a 35 x 35 x 1.5 mm FR4 Substrate, with a single layer of a specified copper area of 2 oz (0.07 mm thick) copper traces and heat spreading area. JEDEC 51 specifications for a low and high conductivity test board recommend a 2 oz copper thickness. Test conditions are under natural convection or zero air flow.

NCP3335A

ELECTRICAL CHARACTERISTICS – 5.0 V ($V_{out} = 5.0$ V typical, $V_{in} = 5.4$ V, $T_A = -40^\circ\text{C}$ to $+85^\circ\text{C}$, unless otherwise noted, Note 2.)

| Characteristic | Symbol | Min | Typ | Max | Unit |
|---|--|----------------|---|---|---|
| Output Voltage (Accuracy) $V_{in} = 5.4$ V to 9.0 V, $I_{load} = 0.1$ mA to 500 mA, $T_A = 25^\circ\text{C}$ | V_{out} | -0.9% 4.955 | 5.0 | +0.9% 5.045 | V |
| Output Voltage (Accuracy) $V_{in} = 5.4$ V to 9.0 V, $I_{load} = 0.1$ mA to 500 mA, $T_A = 0^\circ\text{C}$ to $+85^\circ\text{C}$ | V_{out} | -1.4% 4.930 | 5.0 | +1.4% 5.070 | V |
| Output Voltage (Accuracy) $V_{in} = 5.4$ V to 9.0 V, $I_{load} = 0.1$ mA to 500 mA, $T_A = -40^\circ\text{C}$ to $+125^\circ\text{C}$ | V_{out} | -1.5% 4.925 | 5.0 | +1.5% 5.075 | V |
| Line Regulation $V_{in} = 5.4$ V to 12 V, $I_{load} = 0.1$ mA | LineReg | | 0.04 | | mV/V |
| Load Regulation $V_{in} = 5.4$ V, $I_{load} = 0.1$ mA to 500 mA | LoadReg | | 0.04 | | mV/mA |
| Dropout Voltage (See App Note) $I_{load} = 500$ mA $I_{load} = 300$ mA $I_{load} = 50$ mA $I_{load} = 0.1$ mA | V_{DO} | | | 340 230 110 10 | mV |
| Peak Output Current (See Figure 16) | I_{pk} | 500 | 700 | 830 | mA |
| Short Output Current (See Figure 16) | I_{sc} | | | 930 | mA |
| Thermal Shutdown | T_J | | 160 | | $^\circ\text{C}$ |
| Ground Current In Regulation $I_{load} = 500$ mA (Note 3) $I_{load} = 300$ mA (Note 3) $I_{load} = 50$ mA $I_{load} = 0.1$ mA In Dropout $V_{in} = 4.9$ V, $I_{load} = 0.1$ mA In Shutdown $S_D = 0$ V | I_{GND} I_{GNDsh} | | 9.0 4.6 0.8 – – 0.07 | 14 7.5 2.5 190 500 1.0 | mA μA |
| Output Noise $C_{nr} = 0$ nF, $I_{load} = 500$ mA, $f = 10$ Hz to 100 kHz, $C_{out} = 10$ μF $C_{nr} = 10$ nF, $I_{load} = 500$ mA, $f = 10$ Hz to 100 kHz, $C_{out} = 10$ μF | V_{noise} | | 93 58 | | μVrms μVrms |
| Shutdown Threshold Voltage ON Threshold Voltage OFF | | 2.0 | | 0.4 | V V |
| S_D Input Current, $V_{SD} = 0$ V to 0.4 V or $V_{SD} = 2.0$ V to V_{in} | I_{SD} | | 0.07 | 1.0 | μA |
| Output Current In Shutdown Mode, $V_{out} = 0$ V | I_{OSD} | | 0.07 | 1.0 | μA |
| Reverse Bias Protection, Current Flowing from the Output Pin to GND ($V_{in} = 0$ V, $V_{out_forced} = 5.0$ V) | I_{OUTR} | | 10 | | μA |

- Performance guaranteed over the operating temperature range by design and/or characterization, production tested at $T_J = T_A = 25^\circ\text{C}$. Low duty cycle pulse techniques are used during testing to maintain the junction temperature as close to ambient as possible.
- T_A must be greater than 0°C .

NCP3335A

ELECTRICAL CHARACTERISTICS – 3.3 V ($V_{out} = 3.3$ V typical, $V_{in} = 3.7$ V, $T_A = -40^\circ\text{C}$ to $+85^\circ\text{C}$, unless otherwise noted, Note 4.)

| Characteristic | Symbol | Min | Typ | Max | Unit |
|--|--|----------------|---|---|---|
| Output Voltage (Accuracy) $V_{in} = 3.7$ V to 7.3 V, $I_{load} = 0.1$ mA to 500 mA, $T_A = 25^\circ\text{C}$ | V_{out} | -0.9% 3.270 | 3.3 | +0.9% 3.330 | V |
| Output Voltage (Accuracy) $V_{in} = 3.7$ V to 7.3 V, $I_{load} = 0.1$ mA to 500 mA, $T_A = 0^\circ\text{C}$ to $+85^\circ\text{C}$ | V_{out} | -1.4% 3.254 | 3.3 | +1.4% 3.346 | V |
| Output Voltage (Accuracy) $V_{in} = 3.7$ V to 7.3 V, $I_{load} = 0.1$ mA to 500 mA, $T_A = -40^\circ\text{C}$ to $+125^\circ\text{C}$ | V_{out} | -1.5% 3.250 | 3.3 | +1.5% 3.350 | V |
| Line Regulation $V_{in} = 3.7$ V to 12 V, $I_{load} = 0.1$ mA | LineReg | | 0.04 | | mV/V |
| Load Regulation $V_{in} = 3.7$ V, $I_{load} = 0.1$ mA to 500 mA | LoadReg | | 0.04 | | mV/mA |
| Dropout Voltage (See App Note) $I_{load} = 500$ mA $I_{load} = 300$ mA $I_{load} = 50$ mA $I_{load} = 0.1$ mA | V_{DO} | | | 340 230 110 10 | mV |
| Peak Output Current (See Figure 16) | I_{pk} | 500 | 700 | 800 | mA |
| Short Output Current (See Figure 16) | I_{sc} | | | 900 | mA |
| Thermal Shutdown | T_J | | 160 | | $^\circ\text{C}$ |
| Ground Current In Regulation $I_{load} = 500$ mA (Note 5) $I_{load} = 300$ mA $I_{load} = 50$ mA $I_{load} = 0.1$ mA In Dropout $V_{in} = 3.2$ V, $I_{load} = 0.1$ mA In Shutdown $S_D = 0$ V | I_{GND} I_{GNDsh} | | 9.0 4.6 0.8 – – 0.07 | 14 7.5 2.5 190 500 1.0 | mA μA |
| Output Noise $C_{nr} = 0$ nF, $I_{load} = 500$ mA, $f = 10$ Hz to 100 kHz, $C_{out} = 10$ μF $C_{nr} = 10$ nF, $I_{load} = 500$ mA, $f = 10$ Hz to 100 kHz, $C_{out} = 10$ μF | V_{noise} | | 69 46 | | μVrms μVrms |
| Shutdown Threshold Voltage ON Threshold Voltage OFF | | 2.0 | | 0.4 | V V |
| S_D Input Current, $V_{SD} = 0$ V to 0.4 V or $V_{SD} = 2.0$ V to V_{in} | I_{SD} | | 0.07 | 1.0 | μA |
| Output Current In Shutdown Mode, $V_{out} = 0$ V | I_{OSD} | | 0.07 | 1.0 | μA |
| Reverse Bias Protection, Current Flowing from the Output Pin to GND ($V_{in} = 0$ V, $V_{out_forced} = 3.3$ V) | I_{OUTR} | | 10 | | μA |

4. Performance guaranteed over the operating temperature range by design and/or characterization, production tested at $T_J = T_A = 25^\circ\text{C}$. Low duty cycle pulse techniques are used during testing to maintain the junction temperature as close to ambient as possible.
5. T_A must be greater than 0°C .

NCP3335A

ELECTRICAL CHARACTERISTICS – 3.0 V ($V_{out} = 3.0$ V typical, $V_{in} = 3.4$ V, $T_A = -40^{\circ}\text{C}$ to $+85^{\circ}\text{C}$, unless otherwise noted, Note 6.)

| Characteristic | Symbol | Min | Typ | Max | Unit |
|--|--|----------------|---|---|---|
| Output Voltage (Accuracy) $V_{in} = 3.4$ V to 7.0 V, $I_{load} = 0.1$ mA to 500 mA, $T_A = 25^{\circ}\text{C}$ | V_{out} | -0.9% 2.973 | 3.0 | +0.9% 3.027 | V |
| Output Voltage (Accuracy) $V_{in} = 3.4$ V to 7.0 V, $I_{load} = 0.1$ mA to 500 mA, $T_A = 0^{\circ}\text{C}$ to $+85^{\circ}\text{C}$ | V_{out} | -1.4% 2.958 | 3.0 | +1.4% 3.042 | V |
| Output Voltage (Accuracy) $V_{in} = 3.4$ V to 7.0 V, $I_{load} = 0.1$ mA to 500 mA, $T_A = -40^{\circ}\text{C}$ to $+125^{\circ}\text{C}$ | V_{out} | -1.5% 2.955 | 3.0 | +1.5% 3.045 | V |
| Line Regulation $V_{in} = 3.4$ V to 12 V, $I_{load} = 0.1$ mA | LineReg | | 0.04 | | mV/V |
| Load Regulation $V_{in} = 3.4$ V, $I_{load} = 0.1$ mA to 500 mA | LoadReg | | 0.04 | | mV/mA |
| Dropout Voltage (See App Note) $I_{load} = 500$ mA $I_{load} = 300$ mA $I_{load} = 50$ mA $I_{load} = 0.1$ mA | V_{DO} | | | 340 230 110 10 | mV |
| Peak Output Current (See Figure 16) | I_{pk} | 500 | 700 | 800 | mA |
| Short Output Current (See Figure 16) | I_{sc} | | | 900 | mA |
| Thermal Shutdown | T_J | | 160 | | $^{\circ}\text{C}$ |
| Ground Current In Regulation $I_{load} = 500$ mA (Note 7) $I_{load} = 300$ mA $I_{load} = 50$ mA $I_{load} = 0.1$ mA In Dropout $V_{in} = 2.9$ V, $I_{load} = 0.1$ mA In Shutdown $S_D = 0$ V | I_{GND} I_{GNDsh} | | 9.0 4.6 0.8 – – 0.07 | 14 7.5 2.5 190 500 1.0 | mA μA |
| Output Noise $C_{nr} = 0$ nF, $I_{load} = 500$ mA, $f = 10$ Hz to 100 kHz, $C_{out} = 10$ μF $C_{nr} = 10$ nF, $I_{load} = 500$ mA, $f = 10$ Hz to 100 kHz, $C_{out} = 10$ μF | V_{noise} | | 56 37 | | μVrms μVrms |
| Shutdown Threshold Voltage ON Threshold Voltage OFF | | 2.0 | | 0.4 | V V |
| S_D Input Current, $V_{SD} = 0$ V to 0.4 V or $V_{SD} = 2.0$ V to V_{in} | I_{SD} | | 0.07 | 1.0 | μA |
| Output Current In Shutdown Mode, $V_{out} = 0$ V | I_{OSD} | | 0.07 | 1.0 | μA |
| Reverse Bias Protection, Current Flowing from the Output Pin to GND ($V_{in} = 0$ V, $V_{out_forced} = 3.0$ V) | I_{OUTR} | | 10 | | μA |

6. Performance guaranteed over the operating temperature range by design and/or characterization, production tested at $T_J = T_A = 25^{\circ}\text{C}$. Low duty cycle pulse techniques are used during testing to maintain the junction temperature as close to ambient as possible.
7. T_A must be greater than 0°C .

NCP3335A

ELECTRICAL CHARACTERISTICS – 2.85 V ($V_{out} = 2.85$ V typical, $V_{in} = 3.25$ V, $T_A = -40^\circ\text{C}$ to $+85^\circ\text{C}$, unless otherwise noted, Note 8)

| Characteristic | Symbol | Min | Typ | Max | Unit |
|--|-------------|----------------|------------------------|-------------------------|--------------------------------------|
| Output Voltage (Accuracy) $V_{in} = 3.25$ V to 6.85 V, $I_{load} = 0.1$ mA to 500 mA, $T_A = 25^\circ\text{C}$ | V_{out} | -0.9% 2.824 | 2.85 | +0.9% 2.876 | V |
| Output Voltage (Accuracy) $V_{in} = 3.25$ V to 6.85 V, $I_{load} = 0.1$ mA to 500 mA, $T_A = 0^\circ\text{C}$ to $+85^\circ\text{C}$ | V_{out} | -1.4% 2.810 | 2.85 | +1.4% 2.890 | V |
| Output Voltage (Accuracy) (Note 9) $V_{in} = 3.25$ V to 6.85 V, $I_{load} = 0.1$ mA to 500 mA, $T_A = -40^\circ\text{C}$ to $+125^\circ\text{C}$ | V_{out} | -1.5% 2.807 | 2.85 | +1.5% 2.893 | V |
| Line Regulation $V_{in} = 3.25$ V to 12 V, $I_{load} = 0.1$ mA | LineReg | | 0.04 | | mV/V |
| Load Regulation $V_{in} = 3.25$ V, $I_{load} = 0.1$ mA to 500 mA | LoadReg | | 0.04 | | mV/mA |
| Dropout Voltage (See App Note) $I_{load} = 500$ mA $I_{load} = 300$ mA $I_{load} = 50$ mA $I_{load} = 0.1$ mA | V_{DO} | | | 340 230 110 10 | mV |
| Peak Output Current (See Figure 16) | I_{pk} | 500 | 700 | 800 | mA |
| Short Output Current (See Figure 16) | I_{sc} | | | 900 | mA |
| Thermal Shutdown | T_J | | 160 | | $^\circ\text{C}$ |
| Ground Current In Regulation $I_{load} = 500$ mA (Note 10) $I_{load} = 300$ mA $I_{load} = 50$ mA $I_{load} = 0.1$ mA In Dropout $V_{in} = 2.75$ V, $I_{load} = 0.1$ mA In Shutdown $S_D = 0$ V | I_{GND} | | 9.0 4.6 0.8 – | 14 7.5 2.5 190 | mA μA |
| Output Noise $C_{nr} = 0$ nF, $I_{load} = 500$ mA, $f = 10$ Hz to 100 kHz, $C_{out} = 10$ μF $C_{nr} = 10$ nF, $I_{load} = 500$ mA, $f = 10$ Hz to 100 kHz, $C_{out} = 10$ μF | V_{noise} | | 61 40 | | μVrms μVrms |
| Shutdown Threshold Voltage ON Threshold Voltage OFF | | 2.0 | | 0.4 | V V |
| S_D Input Current, $V_{SD} = 0$ V to 0.4 V or $V_{SD} = 2.0$ V to V_{in} | I_{SD} | | 0.07 | 1.0 | μA |
| Output Current In Shutdown Mode, $V_{out} = 0$ V | I_{OSD} | | 0.07 | 1.0 | μA |
| Reverse Bias Protection, Current Flowing from the Output Pin to GND ($V_{in} = 0$ V, $V_{out_forced} = 2.85$ V) | I_{OUTR} | | 10 | | μA |

8. Performance guaranteed over the operating temperature range by design and/or characterization, production tested at $T_J = T_A = 25^\circ\text{C}$. Low duty cycle pulse techniques are used during testing to maintain the junction temperature as close to ambient as possible.
9. For output current capability for $T_A < 0^\circ\text{C}$, please refer to Figure 18.
10. T_A must be greater than 0°C .

NCP3335A

ELECTRICAL CHARACTERISTICS – 2.8 V ($V_{out} = 2.8$ V typical, $V_{in} = 3.2$ V, $T_A = -40^{\circ}\text{C}$ to $+85^{\circ}\text{C}$, unless otherwise noted, Note 11.)

| Characteristic | Symbol | Min | Typ | Max | Unit |
|---|--|----------------|----------------------------------|--------------------------------|---|
| Output Voltage (Accuracy) $V_{in} = 3.2$ V to 6.8 V, $I_{load} = 0.1$ mA to 500 mA, $T_A = 25^{\circ}\text{C}$ | V_{out} | -0.9% 2.774 | 2.8 | +0.9% 2.826 | V |
| Output Voltage (Accuracy) $V_{in} = 3.2$ V to 6.8 V, $I_{load} = 0.1$ mA to 500 mA, $T_A = 0^{\circ}\text{C}$ to $+85^{\circ}\text{C}$ | V_{out} | -1.4% 2.760 | 2.8 | +1.4% 2.840 | V |
| Output Voltage (Accuracy) (Note 12) $V_{in} = 3.2$ V to 6.8 V, $I_{load} = 0.1$ mA to 500 mA, $T_A = -40^{\circ}\text{C}$ to $+125^{\circ}\text{C}$ | V_{out} | -1.5% 2.758 | 2.8 | +1.5% 2.842 | V |
| Line Regulation $V_{in} = 3.2$ V to 12 V, $I_{load} = 0.1$ mA | LineReg | | 0.04 | | mV/V |
| Load Regulation $V_{in} = 3.2$ V, $I_{load} = 0.1$ mA to 500 mA | LoadReg | | 0.04 | | mV/mA |
| Dropout Voltage (See App Note) $I_{load} = 500$ mA $I_{load} = 300$ mA $I_{load} = 50$ mA $I_{load} = 0.1$ mA | V_{DO} | | | 340 230 110 10 | mV |
| Peak Output Current (See Figure 16) | I_{pk} | 500 | 700 | 800 | mA |
| Short Output Current (See Figure 16) | I_{sc} | | | 900 | mA |
| Thermal Shutdown | T_J | | 160 | | $^{\circ}\text{C}$ |
| Ground Current In Regulation $I_{load} = 500$ mA (Note 13) $I_{load} = 300$ mA (Note 13) $I_{load} = 50$ mA $I_{load} = 0.1$ mA In Dropout $V_{in} = 2.7$ V, $I_{load} = 0.1$ mA In Shutdown $S_D = 0$ V | I_{GND} I_{GNDsh} | | 9.0 4.6 0.8 – – – | 14 7.5 2.5 190 500 | mA μA |
| Output Noise $C_{nr} = 0$ nF, $I_{load} = 500$ mA, $f = 10$ Hz to 100 kHz, $C_{out} = 10$ μF $C_{nr} = 10$ nF, $I_{load} = 500$ mA, $f = 10$ Hz to 100 kHz, $C_{out} = 10$ μF | V_{noise} | | 52 36 | | μVrms μVrms |
| Shutdown Threshold Voltage ON Threshold Voltage OFF | | 2.0 | | 0.4 | V V |
| S_D Input Current, $V_{SD} = 0$ V to 0.4 V or $V_{SD} = 2.0$ V to V_{in} | I_{SD} | | 0.07 | 1.0 | μA |
| Output Current In Shutdown Mode, $V_{out} = 0$ V | I_{OSD} | | 0.07 | 1.0 | μA |
| Reverse Bias Protection, Current Flowing from the Output Pin to GND ($V_{in} = 0$ V, $V_{out_forced} = 2.8$ V) | I_{OUTR} | | 10 | | μA |

11. Performance guaranteed over the operating temperature range by design and/or characterization, production tested at $T_J = T_A = 25^{\circ}\text{C}$. Low duty cycle pulse techniques are used during testing to maintain the junction temperature as close to ambient as possible.

12. For output current capability for $T_A < 0^{\circ}\text{C}$, please refer to Figure 19.

13. T_A must be greater than 0°C .

NCP3335A

ELECTRICAL CHARACTERISTICS – 2.5 V ($V_{out} = 2.5$ V typical, $V_{in} = 2.9$ V, $T_A = -40^\circ\text{C}$ to $+85^\circ\text{C}$, unless otherwise noted, Note 14.)

| Characteristic | Symbol | Min | Typ | Max | Unit |
|---|-------------|----------------|------------------------|-------------------------|--------------------------------------|
| Output Voltage (Accuracy) $V_{in} = 2.9$ V to 6.5 V, $I_{load} = 0.1$ mA to 500 mA, $T_A = 25^\circ\text{C}$ | V_{out} | -0.9% 2.477 | 2.5 | +0.9% 2.523 | V |
| Output Voltage (Accuracy) $V_{in} = 2.9$ V to 6.5 V, $I_{load} = 0.1$ mA to 500 mA, $T_A = 0^\circ\text{C}$ to $+85^\circ\text{C}$ | V_{out} | -1.4% 2.465 | 2.5 | +1.4% 2.535 | V |
| Output Voltage (Accuracy), (Note 15) $V_{in} = 2.9$ V to 6.5 V, $I_{load} = 0.1$ mA to 500 mA, $T_A = -40^\circ\text{C}$ to $+125^\circ\text{C}$ | V_{out} | -1.5% 2.462 | 2.5 | +1.5% 2.538 | V |
| Line Regulation $V_{in} = 2.9$ V to 12 V, $I_{load} = 0.1$ mA | LineReg | | 0.04 | | mV/V |
| Load Regulation $V_{in} = 2.9$ V, $I_{load} = 0.1$ mA to 500 mA | LoadReg | | 0.04 | | mV/mA |
| Dropout Voltage (See App Note) $I_{load} = 500$ mA (Note 16) $I_{load} = 300$ mA (Note 16) $I_{load} = 50$ mA $I_{load} = 0.1$ mA | V_{DO} | | | 340 230 110 10 | mV |
| Peak Output Current (See Figure 16) | I_{pk} | 500 | 700 | 800 | mA |
| Short Output Current (See Figure 16) | I_{sc} | | | 900 | mA |
| Thermal Shutdown | T_J | | 160 | | $^\circ\text{C}$ |
| Ground Current In Regulation $I_{load} = 500$ mA (Note 16) $I_{load} = 300$ mA (Note 16) $I_{load} = 50$ mA $I_{load} = 0.1$ mA In Dropout $V_{in} = 2.4$ V, $I_{load} = 0.1$ mA In Shutdown $S_D = 0$ V | I_{GND} | | 9.0 4.6 0.8 – | 14 7.5 2.5 190 | mA μA |
| Output Noise $C_{nr} = 0$ nF, $I_{load} = 500$ mA, $f = 10$ Hz to 100 kHz, $C_{out} = 10$ μF $C_{nr} = 10$ nF, $I_{load} = 500$ mA, $f = 10$ Hz to 100 kHz, $C_{out} = 10$ μF | V_{noise} | | 56 35 | | μVrms μVrms |
| Shutdown Threshold Voltage ON Threshold Voltage OFF | | 2.0 | | 0.4 | V V |
| S_D Input Current, $V_{SD} = 0$ V to 0.4 V or $V_{SD} = 2.0$ V to V_{in} | I_{SD} | | 0.07 | 1.0 | μA |
| Output Current In Shutdown Mode, $V_{out} = 0$ V | I_{OSD} | | 0.07 | 1.0 | μA |
| Reverse Bias Protection, Current Flowing from the Output Pin to GND ($V_{in} = 0$ V, $V_{out_forced} = 2.5$ V) | I_{OUTR} | | 10 | | μA |

14. Performance guaranteed over the operating temperature range by design and/or characterization, production tested at $T_J = T_A = 25^\circ\text{C}$. Low duty cycle pulse techniques are used during testing to maintain the junction temperature as close to ambient as possible.

15. For output current capability for $T_A < 0^\circ\text{C}$, please refer to Figure 20.

16. T_A must be greater than 0°C .

NCP3335A

ELECTRICAL CHARACTERISTICS – 1.8 V ($V_{out} = 1.8$ V typical, $V_{in} = 2.9$ V, $T_A = -40^{\circ}\text{C}$ to $+85^{\circ}\text{C}$, unless otherwise noted, Note 17.)

| Characteristic | Symbol | Min | Typ | Max | Unit |
|---|--|----------------|------------------------|------------------------------------|---|
| Output Voltage (Accuracy) $V_{in} = 2.9$ V to 5.8 V, $I_{load} = 0.1$ mA to 500 mA, $T_A = 25^{\circ}\text{C}$ | V_{out} | -0.9% 1.783 | 1.8 | +0.9% 1.817 | V |
| Output Voltage (Accuracy) $V_{in} = 2.9$ V to 5.8 V, $I_{load} = 0.1$ mA to 500 mA, $T_A = 0^{\circ}\text{C}$ to $+85^{\circ}\text{C}$ | V_{out} | -1.4% 1.774 | 1.8 | +1.4% 1.826 | V |
| Output Voltage (Accuracy), (Note 18) $V_{in} = 2.9$ V to 5.8 V, $I_{load} = 0.1$ mA to 500 mA, $T_A = -40^{\circ}\text{C}$ to $+125^{\circ}\text{C}$ | V_{out} | -1.5% 1.773 | 1.8 | +1.5% 1.827 | V |
| Line Regulation $V_{in} = 2.9$ V to 12 V, $I_{load} = 0.1$ mA | LineReg | | 0.04 | | mV/V |
| Load Regulation $V_{in} = 2.9$ V, $I_{load} = 0.1$ mA to 500 mA | LoadReg | | 0.04 | | mV/mA |
| Dropout Voltage (See App Note) $I_{load} = 500$ mA (Notes 19, 20) $I_{load} = 300$ mA (Notes 19, 20) $I_{load} = 50$ mA (Notes 19, 20) | V_{DO} | | 620 230 95 | 1130 1130 1130 | mV |
| Peak Output Current (See Figure 16) | I_{pk} | 500 | 700 | 830 | mA |
| Short Output Current (See Figure 16) | I_{sc} | | | 900 | mA |
| Thermal Shutdown | T_J | | 160 | | $^{\circ}\text{C}$ |
| Ground Current In Regulation $I_{load} = 500$ mA (Note 19) $I_{load} = 300$ mA (Note 19) $I_{load} = 50$ mA $I_{load} = 0.1$ mA In Dropout $V_{in} = 2.2$ V, $I_{load} = 0.1$ mA In Shutdown $S_D = 0$ V | I_{GND} I_{GNDsh} | | 9.0 4.6 0.8 – | 14 7.5 2.5 190 500 | mA μA |
| Output Noise $C_{nr} = 0$ nF, $I_{load} = 500$ mA, $f = 10$ Hz to 100 kHz, $C_{out} = 10$ μF $C_{nr} = 10$ nF, $I_{load} = 500$ mA, $f = 10$ Hz to 100 kHz, $C_{out} = 10$ μF | V_{noise} | | 52 33 | | μVrms μVrms |
| Shutdown Threshold Voltage ON Threshold Voltage OFF | | 2.0 | | 0.4 | V V |
| S_D Input Current, $V_{SD} = 0$ V to 0.4 V or $V_{SD} = 2.0$ V to V_{in} | I_{SD} | | 0.07 | 1.0 | μA |
| Output Current In Shutdown Mode, $V_{out} = 0$ V | I_{OSD} | | 0.07 | 1.0 | μA |
| Reverse Bias Protection, Current Flowing from the Output Pin to GND ($V_{in} = 0$ V, $V_{out_forced} = 1.8$ V) | I_{OUTR} | | 10 | | μA |

17. Performance guaranteed over the operating temperature range by design and/or characterization, production tested at $T_J = T_A = 25^{\circ}\text{C}$. Low duty cycle pulse techniques are used during testing to maintain the junction temperature as close to ambient as possible.

18. For output current capability for $T_A < 0^{\circ}\text{C}$, please refer to Figure 21.

19. T_A must be greater than 0°C .

20. Maximum dropout voltage is limited by minimum input voltage $V_{in} = 2.9$ V recommended for guaranteed operation.

NCP3335A

ELECTRICAL CHARACTERISTICS – 1.5 V ($V_{out} = 1.5$ V typical, $V_{in} = 2.9$ V, $T_A = -40^{\circ}\text{C}$ to $+85^{\circ}\text{C}$, unless otherwise noted, Note 21.)

| Characteristic | Symbol | Min | Typ | Max | Unit |
|---|--|----------------|------------------------|-------------------------|--|
| Output Voltage (Accuracy) $V_{in} = 2.9$ V to 5.5 V, $I_{load} = 0.1$ mA to 500 mA, $T_A = 25^{\circ}\text{C}$ | V_{out} | -0.9% 1.486 | 1.5 | +0.9% 1.514 | V |
| Output Voltage (Accuracy) $V_{in} = 2.9$ V to 5.5 V, $I_{load} = 0.1$ mA to 500 mA, $T_A = 0^{\circ}\text{C}$ to $+85^{\circ}\text{C}$ | V_{out} | -1.4% 1.479 | 1.5 | +1.4% 1.521 | V |
| Output Voltage (Accuracy), (Note 22) $V_{in} = 2.9$ V to 5.5 V, $I_{load} = 0.1$ mA to 500 mA, $T_A = -40^{\circ}\text{C}$ to $+125^{\circ}\text{C}$ | V_{out} | -1.5% 1.477 | 1.5 | +1.5% 1.523 | V |
| Line Regulation $V_{in} = 2.9$ V to 12 V, $I_{load} = 0.1$ mA | LineReg | | 0.04 | | mV/V |
| Load Regulation $V_{in} = 2.9$ V, $I_{load} = 0.1$ mA to 500 mA | LoadReg | | 0.04 | | mV/mA |
| Dropout Voltage (See App Note) $I_{load} = 500$ mA (Notes 23, 24) $I_{load} = 300$ mA (Notes 23, 24) $I_{load} = 50$ mA (Notes 23, 24) | V_{DO} | | 940 500 350 | 1430 1430 1430 | mV |
| Peak Output Current (See Figure 16) | I_{pk} | 500 | 700 | 860 | mA |
| Short Output Current (See Figure 16) | I_{sc} | | | 900 | mA |
| Thermal Shutdown | T_J | | 160 | | $^{\circ}\text{C}$ |
| Ground Current In Regulation $I_{load} = 500$ mA (Note 23) $I_{load} = 300$ mA (Note 23) $I_{load} = 50$ mA $I_{load} = 0.1$ mA In Dropout $V_{in} = 2.2$ V, $I_{load} = 0.1$ mA In Shutdown $S_D = 0$ V | I_{GND} I_{GNDsh} | | 9.0 4.6 0.8 – | 14 7.5 2.5 190 | mA μA 500 μA μA |
| Output Noise $C_{nr} = 0$ nF, $I_{load} = 500$ mA, $f = 10$ Hz to 100 kHz, $C_{out} = 10$ μF $C_{nr} = 10$ nF, $I_{load} = 500$ mA, $f = 10$ Hz to 100 kHz, $C_{out} = 10$ μF | V_{noise} | | 51 31 | | μVrms μVrms |
| Shutdown Threshold Voltage ON Threshold Voltage OFF | | 2.0 | | 0.4 | V V |
| S_D Input Current, $V_{SD} = 0$ V to 0.4 V or $V_{SD} = 2.0$ V to V_{in} | I_{SD} | | 0.07 | 1.0 | μA |
| Output Current In Shutdown Mode, $V_{out} = 0$ V | I_{OSD} | | 0.07 | 1.0 | μA |
| Reverse Bias Protection, Current Flowing from the Output Pin to GND ($V_{in} = 0$ V, $V_{out_forced} = 1.5$ V) | I_{OUTR} | | 10 | | μA |

21. Performance guaranteed over the operating temperature range by design and/or characterization, production tested at $T_J = T_A = 25^{\circ}\text{C}$. Low duty cycle pulse techniques are used during testing to maintain the junction temperature as close to ambient as possible.

22. For output current capability for $T_A < 0^{\circ}\text{C}$, please refer to Figure 22.

23. T_A must be greater than 0°C .

24. Maximum dropout voltage is limited by minimum input voltage $V_{in} = 2.9$ V recommended for guaranteed operation.

NCP3335A

ELECTRICAL CHARACTERISTICS – Adjustable ($V_{out} = 1.25\text{ V}$ typical, $V_{in} = 2.9\text{ V}$, $T_A = -40^\circ\text{C}$ to $+85^\circ\text{C}$, unless otherwise noted, Note 25)

| Characteristic | Symbol | Min | Typ | Max | Unit |
|--|--|----------------|---|---|---|
| Reference Voltage (Accuracy) $V_{in} = 2.9\text{ V}$ to $V_{out} + 4.0\text{ V}$, $I_{load} = 0.1\text{ mA}$ to 500 mA , $T_A = 25^\circ\text{C}$ | V_{ref} | -0.9% 1.239 | 1.25 | +0.9% 1.261 | V |
| Reference Voltage (Accuracy) $V_{in} = 2.9\text{ V}$ to $V_{out} + 4.0\text{ V}$, $I_{load} = 0.1\text{ mA}$ to 500 mA , $T_A = 0^\circ\text{C}$ to $+85^\circ\text{C}$ | V_{ref} | -1.4% 1.233 | 1.25 | +1.4% 1.268 | V |
| Reference Voltage (Accuracy) (Note 26) $V_{in} = 2.9\text{ V}$ to $V_{out} + 4.0\text{ V}$, $I_{load} = 0.1\text{ mA}$ to 500 mA , $T_A = -40^\circ\text{C}$ to $+125^\circ\text{C}$ | V_{ref} | -1.5% 1.231 | 1.25 | +1.5% 1.269 | V |
| Line Regulation $V_{in} = 2.9\text{ V}$ to 12 V , $I_{load} = 0.1\text{ mA}$ | LineReg | | 0.04 | | mV/V |
| Load Regulation $V_{in} = 2.9\text{ V}$, $I_{load} = 0.1\text{ mA}$ to 500 mA | LoadReg | | 0.04 | | mV/mA |
| Dropout Voltage (See App Note), $V_{out} = 2.5\text{ V}$ to 10 V $I_{load} = 500\text{ mA}$ (Note 27) $I_{load} = 300\text{ mA}$ $I_{load} = 50\text{ mA}$ $I_{load} = 0.1\text{ mA}$ | V_{DO} | | | 340 230 110 10 | mV |
| Peak Output Current (Note 27) (See Figure 16) | I_{pk} | 500 | 700 | 860 | mA |
| Short Output Current (See Figure 16) $V_{out} \leq 3.3\text{ V}$ $V_{out} > 3.3\text{ V}$ | I_{sc} | | | 900 990 | mA |
| Thermal Shutdown | T_J | | 160 | | $^\circ\text{C}$ |
| Ground Current In Regulation $I_{load} = 500\text{ mA}$ (Note 27) $I_{load} = 300\text{ mA}$ (Note 27) $I_{load} = 50\text{ mA}$ $I_{load} = 0.1\text{ mA}$ In Dropout $V_{in} = V_{out} - 0.1\text{ V}$ or 2.2 V (whichever is higher), $I_{load} = 0.1\text{ mA}$ In Shutdown $S_D = 0\text{ V}$ | I_{GND} I_{GNDsh} | | 9.0 4.6 0.8 – – 0.07 | 14 7.5 2.5 190 500 1.0 | mA μA |
| Output Noise $C_{nr} = 0\text{ nF}$, $I_{load} = 500\text{ mA}$, $f = 10\text{ Hz}$ to 100 kHz , $C_{out} = 10\text{ }\mu\text{F}$ $C_{nr} = 10\text{ nF}$, $I_{load} = 500\text{ mA}$, $f = 10\text{ Hz}$ to 100 kHz , $C_{out} = 10\text{ }\mu\text{F}$ | V_{noise} | | 38 26 | | μVrms μVrms |
| Shutdown Threshold Voltage ON Threshold Voltage OFF | | 2.0 | | 0.4 | V V |
| S_D Input Current, $V_{SD} = 0\text{ V}$ to 0.4 V or $V_{SD} = 2.0\text{ V}$ to V_{in} $V_{in} \leq 5.4\text{ V}$ $V_{in} > 5.4\text{ V}$ | I_{SD} | | 0.07 | 1.0 5.0 | μA |
| Output Current In Shutdown Mode, $V_{out} = 0\text{ V}$ | I_{OSD} | | 0.07 | 1.0 | μA |
| Reverse Bias Protection, Current Flowing from the Output Pin to GND ($V_{in} = 0\text{ V}$, $V_{out_forced} = V_{out}(\text{nom}) \leq 7\text{ V}$) (Note 28) | I_{OUTR} | | 1.0 | | μA |

25. Performance guaranteed over the operating temperature range by design and/or characterization, production tested at $T_J = T_A = 25^\circ\text{C}$. Low duty cycle pulse techniques are used during testing to maintain the junction temperature as close to ambient as possible.

26. For output current capability for $T_A < 0^\circ\text{C}$, please refer to Figures 18 to 22.

27. T_A must be greater than 0°C .

28. Reverse bias protection feature valid only if $V_{out} - V_{in} \leq 7\text{ V}$.

NCP3335A

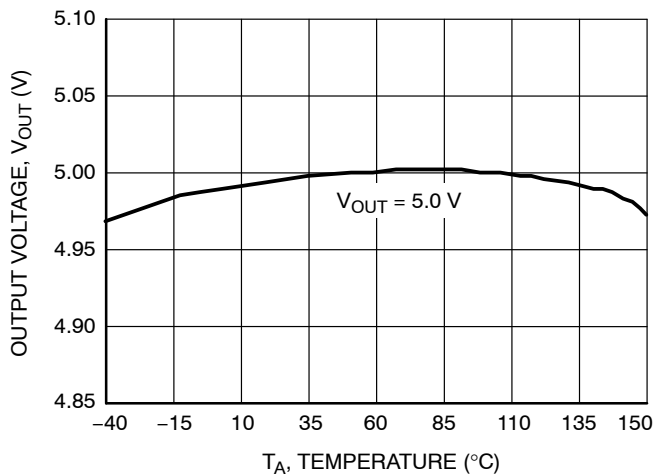

**Figure 5. Output Voltage vs. Temperature
5.0 V Version**

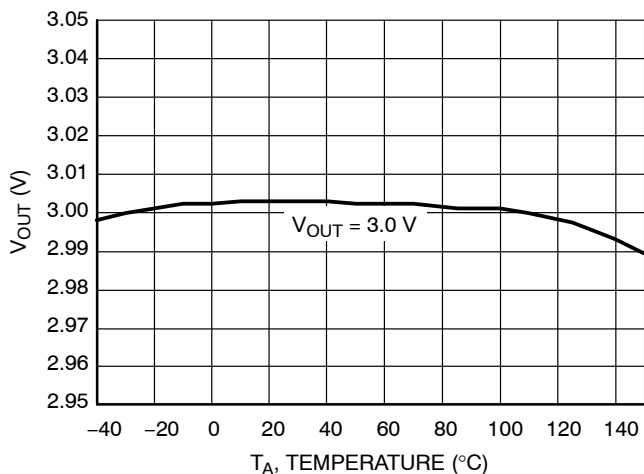

**Figure 6. Output Voltage vs. Temperature
3.0 V Version**

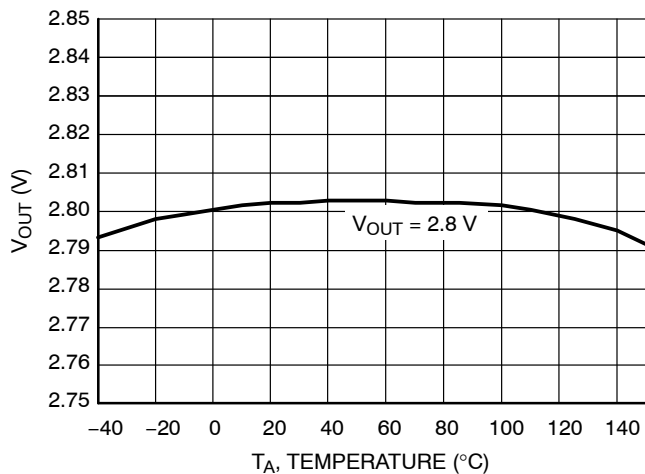

**Figure 7. Output Voltage vs. Temperature
2.8 V Version**

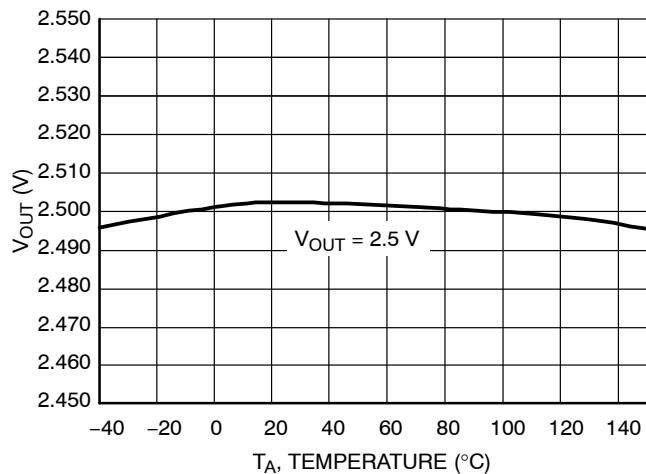

**Figure 8. Output Voltage vs. Temperature
2.5 V Version**

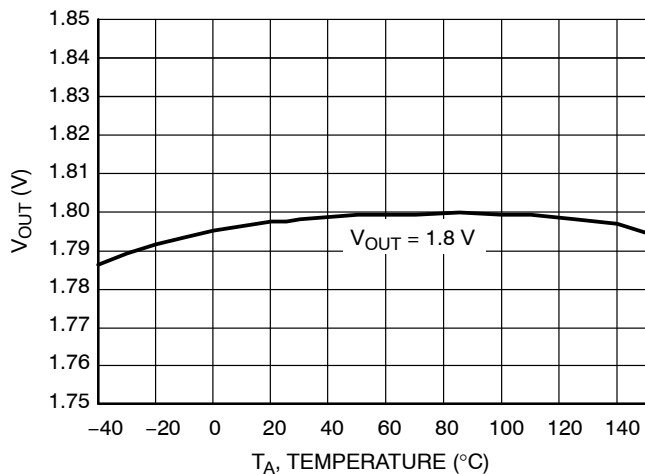

**Figure 9. Output Voltage vs. Temperature
1.8 V Version**

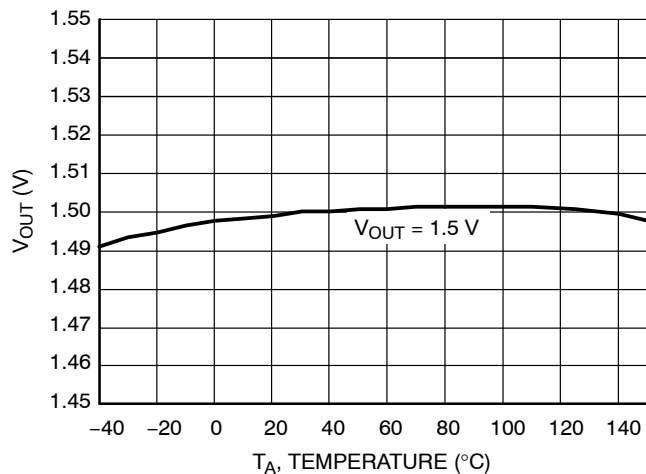

**Figure 10. Output Voltage vs. Temperature
1.5 V Version**

NCP3335A

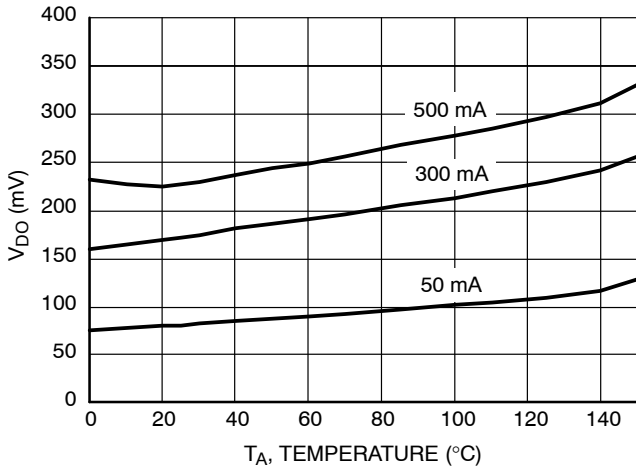

Figure 11. Dropout Voltage vs. Temperature 2.8 V Version

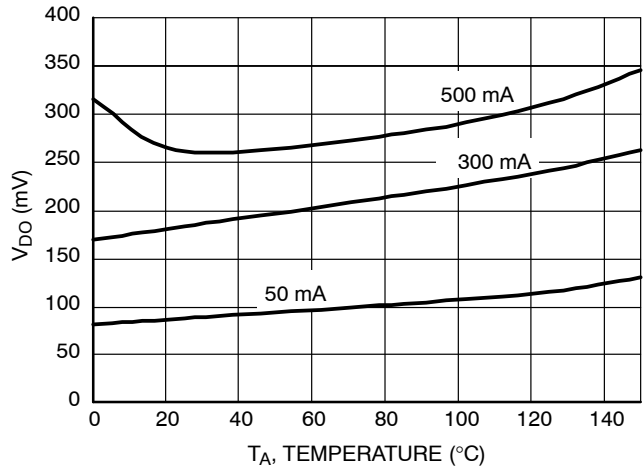

Figure 12. Dropout Voltage vs. Temperature 2.5 V Version

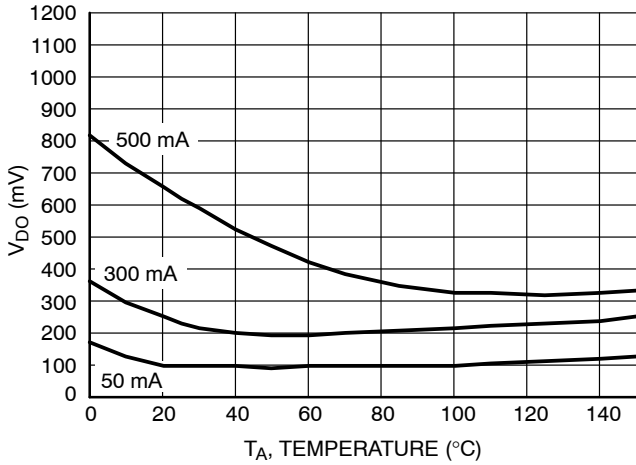

Figure 13. Dropout Voltage vs. Temperature 1.8 V Version

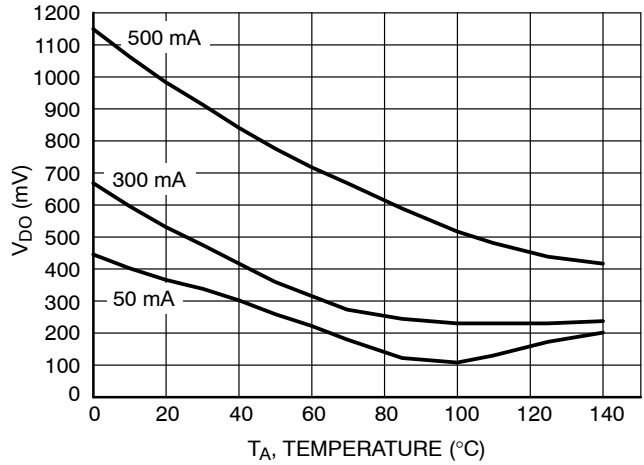

Figure 14. Dropout Voltage vs. Temperature 1.5 V Version

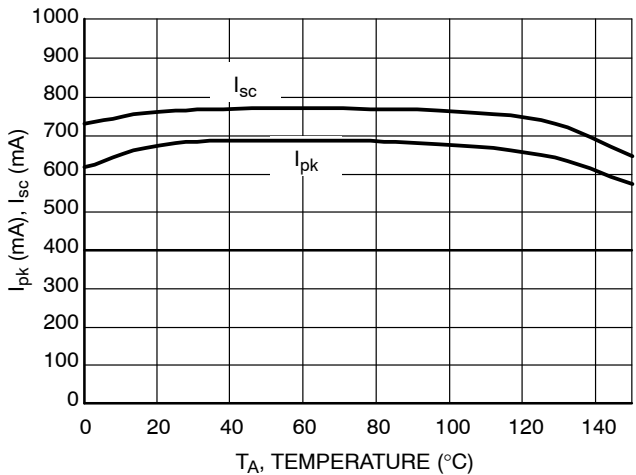

Figure 15. Peak and Short Current vs. Temperature

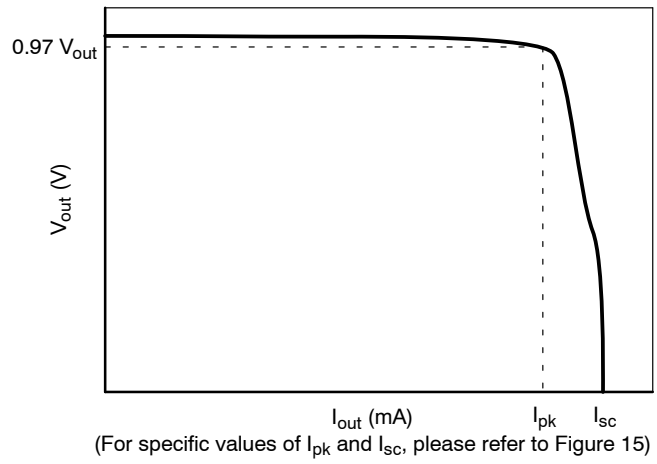

Figure 16. Output Voltage vs. Output Current

NCP3335A

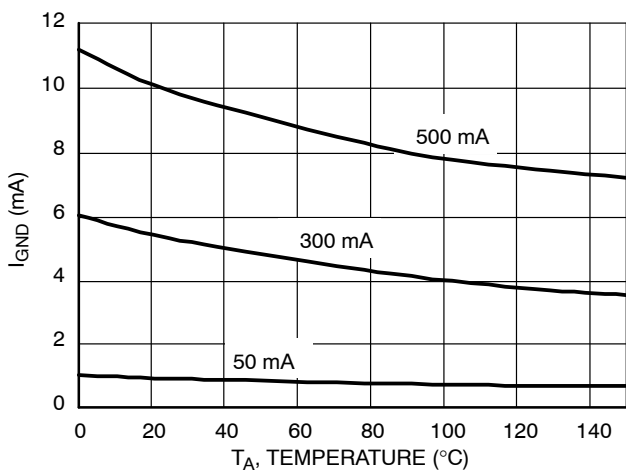

Figure 17. Ground Current vs. Temperature

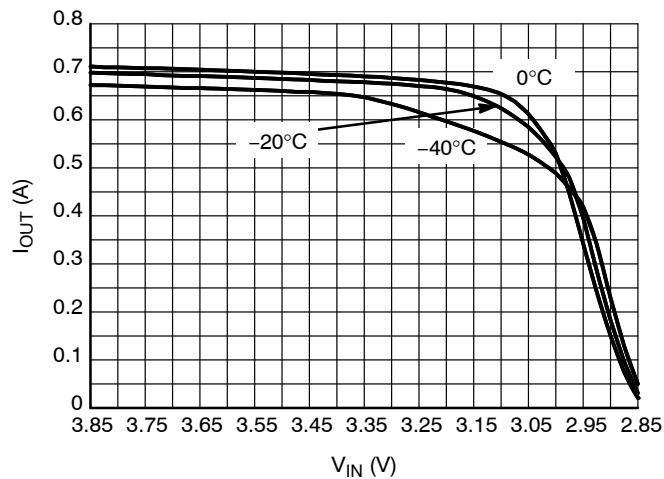

Figure 18. Output Current Capability for the 2.85 V Version

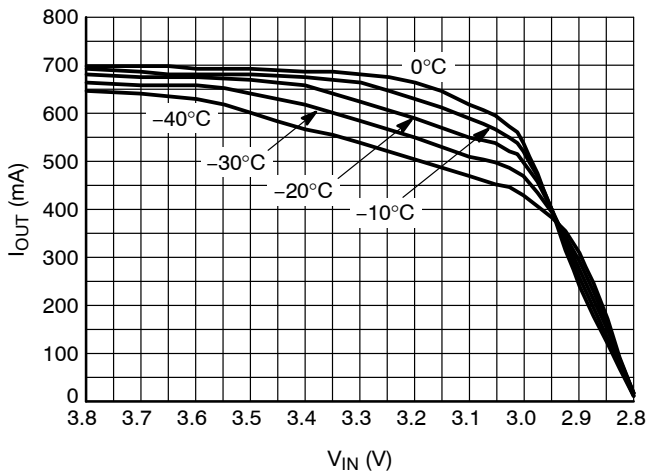

Figure 19. Output Current Capability for the 2.8 V Version

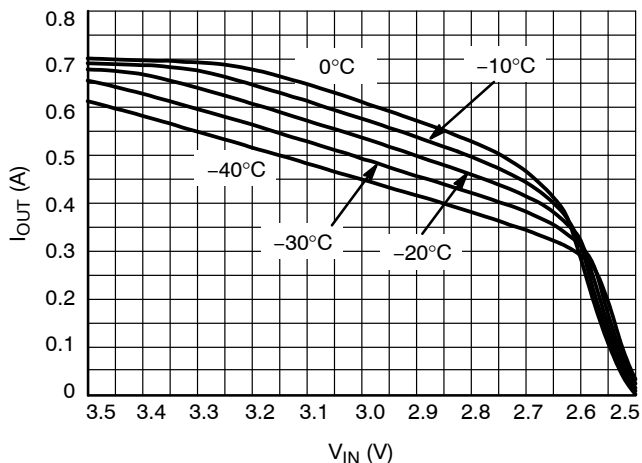

Figure 20. Output Current Capability for the 2.5 V Version

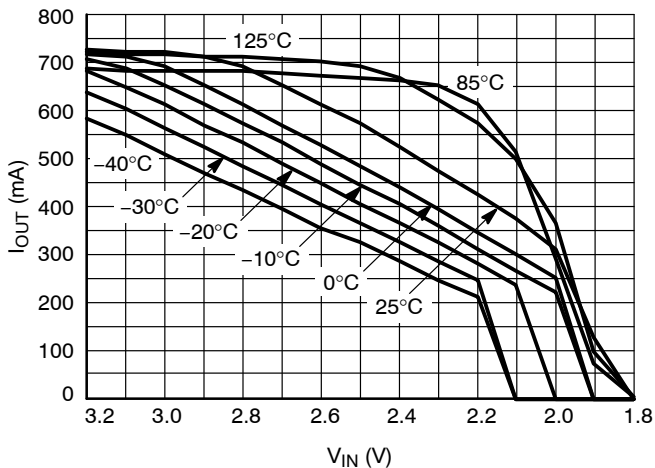

Figure 21. Output Current Capability for the 1.8 V Version

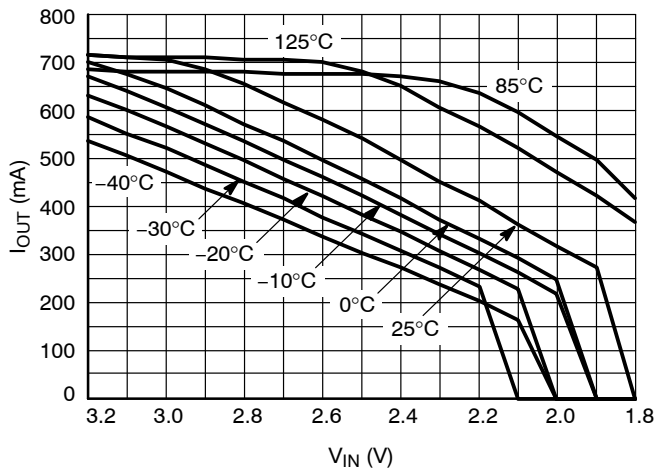

Figure 22. Output Current Capability for the 1.5 V Version

NCP3335A

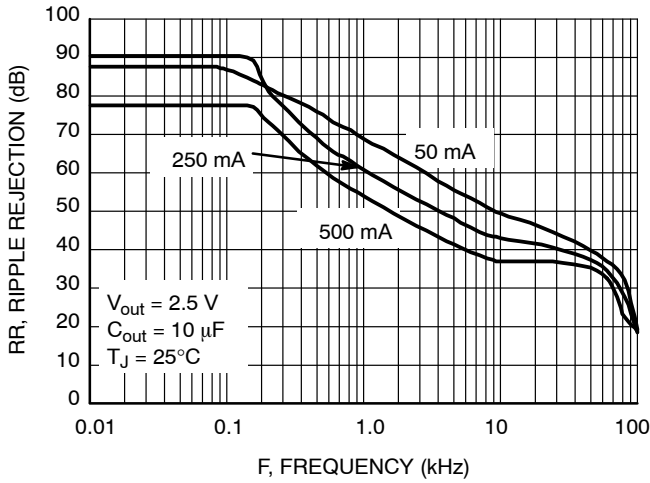

Figure 23. Ripple Rejection vs. Frequency

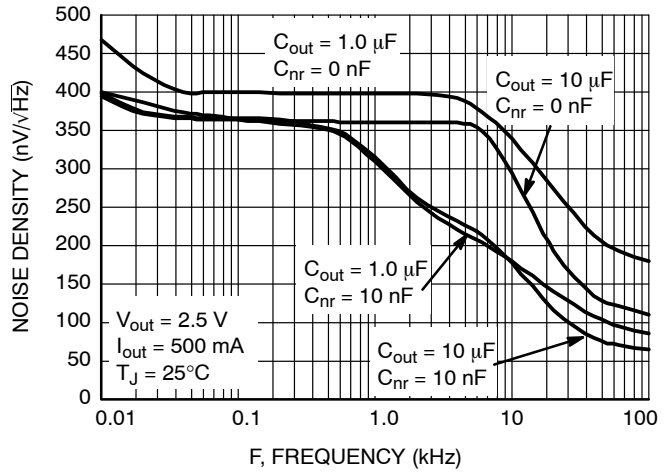

Figure 24. Output Noise Density

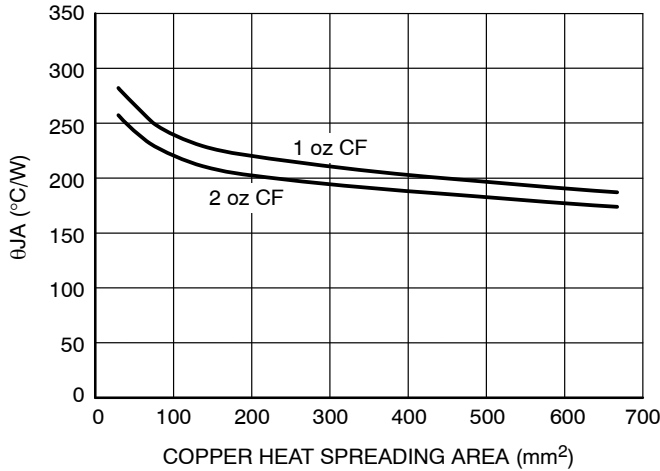

Figure 25. Micro 8 Self Heating Thermal Characteristic as a Function of Copper Area on the PCB

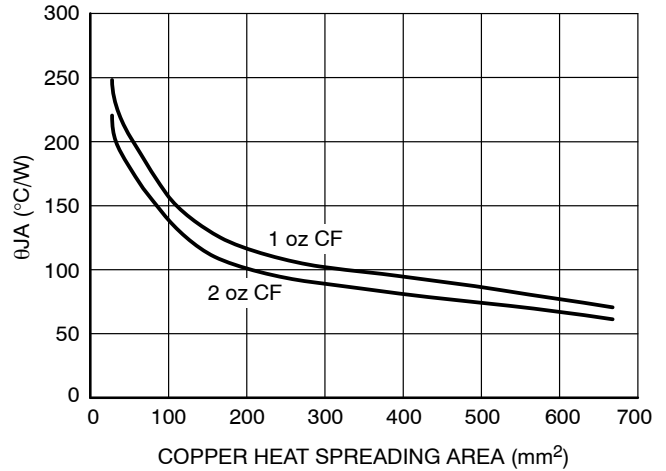

Figure 26. DFN 10 Self Heating Thermal Characteristic as a Function of Copper Area on the PCB

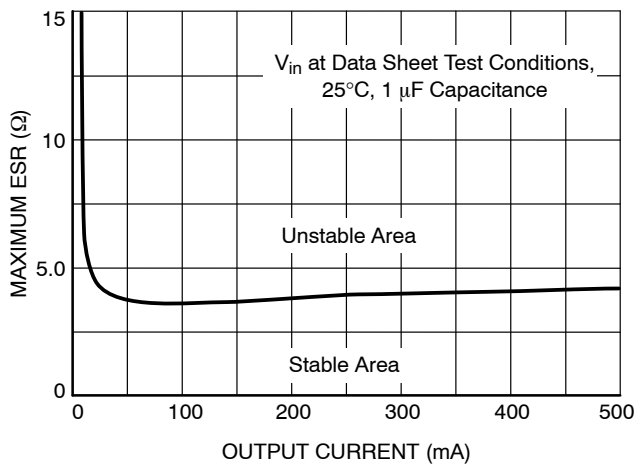

Figure 27. Stability with ESR vs. I_{out}

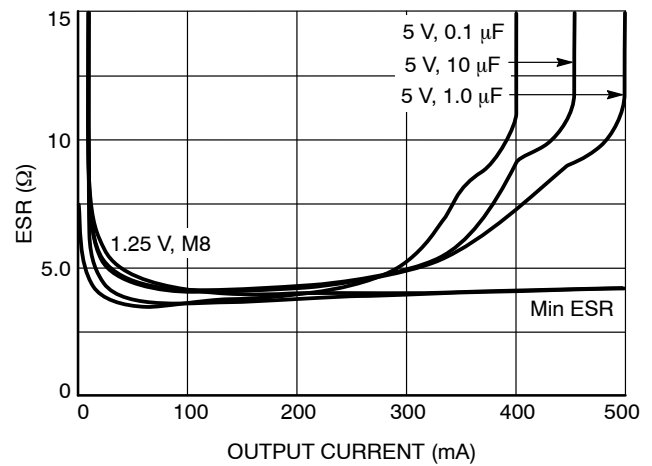

Figure 28. Output Current vs. ESR

NOTE: Typical characteristics were measured with the same conditions as electrical characteristics.

APPLICATIONS INFORMATION

Reverse Bias Protection

Reverse bias is a condition caused when the input voltage goes to zero, but the output voltage is kept high either by a large output capacitor or another source in the application which feeds the output pin.

Normally in a bipolar LDO all the current will flow from the output pin to input pin through the PN junction with limited current capability and with the potential to destroy the IC.

Due to an improved architecture, the NCP3335A can withstand up to 7.0 V on the output pin with virtually no current flowing from output pin to input pin, and only negligible amount of current (tens of μA) flowing from the output pin to ground for infinite duration.

Input Capacitor

An input capacitor of at least 1.0 μF , any type, is recommended to improve the transient response of the regulator and/or if the regulator is located more than a few inches from the power source. It will also reduce the circuit's sensitivity to the input line impedance at high frequencies. The capacitor should be mounted with the shortest possible track length directly across the regular's input terminals.

Output Capacitor

The NCP3335A remains stable with any type of capacitor as long as it fulfills its 1.0 μF requirement. There are no constraints on the minimum ESR and it will remain stable up to an ESR of 5.0 Ω . Larger capacitor values will improve the noise rejection and load transient response.

Noise Reduction Pin

Output noise can be greatly reduced by connecting a 10 nF capacitor (C_{nr}) between the noise reduction pin and ground (see Figure 1). In applications where very low noise is not required, the noise reduction pin can be left unconnected.

For the adjustable version, in addition to the 10 nF C_{nr} , a 68 pF capacitor connected in parallel with R1 (see Figure 2)

is recommended to further reduce output noise and improve stability.

Adjustable Operation

The output voltage can be set by using a resistor divider as shown in Figure 2 with a range of 1.25 to 10 V. The appropriate resistor divider can be found by solving the equation below. The recommended current through the resistor divider is from 10 μA to 100 μA . This can be accomplished by selecting resistors in the $\text{k}\Omega$ range. As result, the $I_{adj} * R_2$ becomes negligible in the equation and can be ignored.

$$V_{out} = 1.25 * \left(1 + \frac{R_1}{R_2}\right) + I_{adj} * R_2 \quad (\text{eq. 1})$$

Example:

For $V_{out} = 2.9 \text{ V}$, can use $R_1 = 36 \text{ k}\Omega$ and $R_2 = 27 \text{ k}\Omega$.

$$1.25 * \left(1 + \frac{36 \text{ k}\Omega}{27 \text{ k}\Omega}\right) = 2.91 \text{ V} \quad (\text{eq. 2})$$

Dropout Voltage

The voltage dropout is measured at 97% of the nominal output voltage.

Thermal Considerations

Internal thermal limiting circuitry is provided to protect the integrated circuit in the event that the maximum junction temperature is exceeded. This feature provides protection from a catastrophic device failure due to accidental overheating. This protection feature is not intended to be used as a substitute to heat sinking. The maximum power that can be dissipated, can be calculated with the equation below:

$$P_D = \frac{T_{J(max)} - T_A}{R_{\theta JA}} \quad (\text{eq. 3})$$

For improved thermal performance, contact the factory for the DFN package option. The DFN package includes an exposed metal pad that is specifically designed to reduce the junction to air thermal resistance, $R_{\theta JA}$.

NCP3335A

ORDERING INFORMATION

| Device | Nominal Output Voltage | Marking | Package | Shipping† |
|------------------|------------------------|---------|---------------------|--------------------|
| NCP3335ADM150R2G | 1.5 V | LKI | Micro8 (Pb-Free) | 4000 / Tape & Reel |
| NCP3335ADM180R2G | 1.8 V | LKJ | Micro8 (Pb-Free) | 4000 / Tape & Reel |
| NCP3335ADM250R2G | 2.5 V | LIQ | Micro8 (Pb-Free) | 4000 / Tape & Reel |
| NCP3335ADM280R2G | 2.8 V | LKK | Micro8 (Pb-Free) | 4000 / Tape & Reel |
| NCP3335ADM285R2G | 2.85 V | LIR | Micro8 (Pb-Free) | 4000 / Tape & Reel |
| NCP3335ADM300R2G | 3.0 V | LKL | Micro8 (Pb-Free) | 4000 / Tape & Reel |
| NCP3335ADM330R2G | 3.3 V | LIS | Micro8 (Pb-Free) | 4000 / Tape & Reel |
| NCP3335ADM500R2G | 5.0 V | LIT | Micro8 (Pb-Free) | 4000 / Tape & Reel |
| NCP3335ADMADJR2G | Adj. | LIO | Micro8 (Pb-Free) | 4000 / Tape & Reel |
| NCP3335AMN150R2G | 1.5 V | 15 | DFN10 (Pb-Free) | 3000 / Tape & Reel |
| NCP3335AMN180R2G | 1.8 V | 18 | DFN10 (Pb-Free) | 3000 / Tape & Reel |
| NCP3335AMN250R2G | 2.5 V | 25 | DFN10 (Pb-Free) | 3000 / Tape & Reel |
| NCP3335AMN280R2G | 2.8 V | 28 | DFN10 (Pb-Free) | 3000 / Tape & Reel |
| NCP3335AMN285R2G | 2.85 V | 285 | DFN10 (Pb-Free) | 3000 / Tape & Reel |
| NCP3335AMN300R2G | 3.0 V | 30 | DFN10 (Pb-Free) | 3000 / Tape & Reel |
| NCP3335AMN330R2G | 3.3 V | 33 | DFN10 (Pb-Free) | 3000 / Tape & Reel |
| NCP3335AMN500R2G | 5.0 V | 50 | DFN10 (Pb-Free) | 3000 / Tape & Reel |
| NCP3335AMNADJR2G | Adj. | ADJ | DFN10 (Pb-Free) | 3000 / Tape & Reel |

†For information on tape and reel specifications, including part orientation and tape sizes, please refer to our Tape and Reel Packaging Specifications Brochure, BRD8011/D.

*Please contact factory for other voltage options.

MECHANICAL CASE OUTLINE PACKAGE DIMENSIONS



SCALE 2:1

DFN10, 3x3, 0.5P CASE 485C ISSUE F

DATE 16 DEC 2021

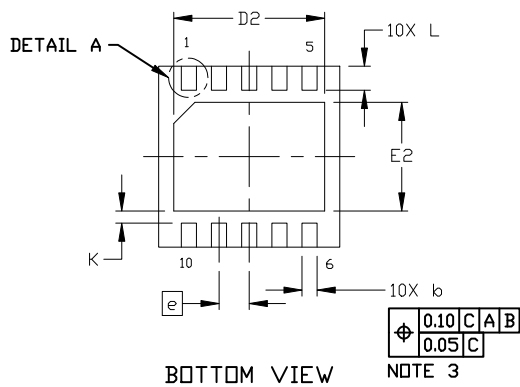
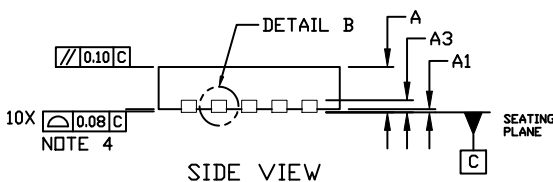
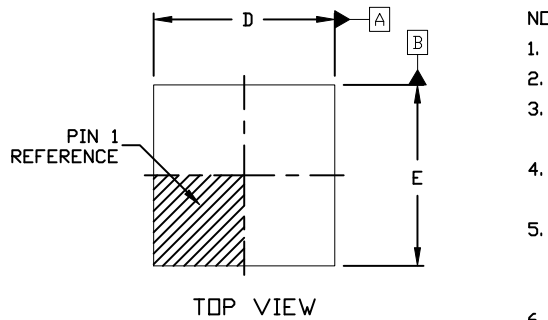

GENERIC MARKING DIAGRAM*



- XXXXX = Specific Device Code
- A = Assembly Location
- L = Wafer Lot
- Y = Year
- W = Work Week
- = Pb-Free Package

(Note: Microdot may be in either location)

NOTES:

1. DIMENSION AND TOLERANCING PER ASME Y14.5, 2009.
2. CONTROLLING DIMENSION: MILLIMETERS
3. DIMENSION *b* APPLIES TO PLATED TERMINAL AND IS MEASURED BETWEEN 0.15 AND 0.30 MM FROM THE TERMINAL TIP.
4. COPLANARITY APPLIES TO THE EXPOSED PAD AS WELL AS THE TERMINALS.
5. TERMINAL *b* MAY HAVE MOLD COMPOUND MATERIAL ALONG SIDE EDGE. MOLD FLASH MAY NOT EXCEED 30 MICRONS ONTO BOTTOM SURFACE OF TERMINAL.
6. FOR DEVICE OPN CONTAINING W OPTION, DETAIL A AND DETAIL B ALTERNATE CONSTRUCTIONS ARE NOT APPLICABLE. WETTABLE FLANK CONSTRUCTION IS DETAIL B AS SHOWN ON SIDE VIEW OF PACKAGE.

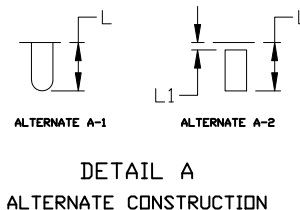
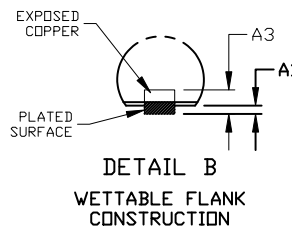
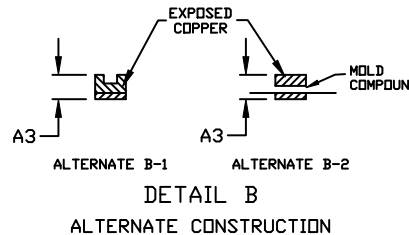

| DIM | MILLIMETERS | | |
|----------|-------------|------|------|
| | MIN. | NOM. | MAX. |
| A | 0.80 | 0.90 | 1.00 |
| A1 | 0.00 | --- | 0.05 |
| A3 | 0.20 REF | | |
| <i>b</i> | 0.18 | 0.23 | 0.30 |
| D | 2.90 | 3.00 | 3.10 |
| D2 | 2.40 | 2.50 | 2.60 |
| E | 2.90 | 3.00 | 3.10 |
| E2 | 1.70 | 1.80 | 1.90 |
| <i>e</i> | 0.50 BSC | | |
| K | 0.20 REF | | |
| L | 0.30 | 0.40 | 0.50 |
| L1 | --- | --- | 0.03 |

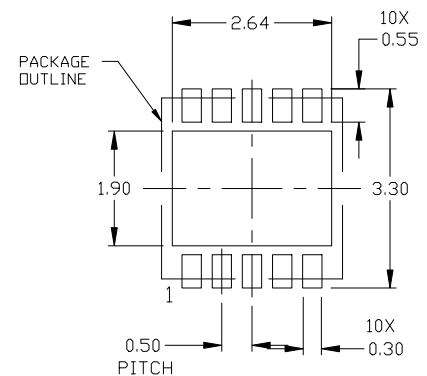

RECOMMENDED MOUNTING FOOTPRINT

For additional information on our Pb-Free strategy and soldering details, please download the ON Semiconductor Soldering and Mounting Techniques Reference Manual, SOLDERRM/D.

*This information is generic. Please refer to device data sheet for actual part marking. Pb-Free indicator, "G" or microdot "▪", may or may not be present. Some products may not follow the Generic Marking.

| | | |
|-------------------------|------------------------------------|--|
| DOCUMENT NUMBER: | 98AON03161D | Electronic versions are uncontrolled except when accessed directly from the Document Repository. Printed versions are uncontrolled except when stamped "CONTROLLED COPY" in red. |
| DESCRIPTION: | DFN10, 3X3 MM, 0.5 MM PITCH | PAGE 1 OF 1 |

onsemi and ONSEMI are trademarks of Semiconductor Components Industries, LLC dba onsemi or its subsidiaries in the United States and/or other countries. onsemi reserves the right to make changes without further notice to any products herein. onsemi makes no warranty, representation or guarantee regarding the suitability of its products for any particular purpose, nor does onsemi assume any liability arising out of the application or use of any product or circuit, and specifically disclaims any and all liability, including without limitation special, consequential or incidental damages. onsemi does not convey any license under its patent rights nor the rights of others.

MECHANICAL CASE OUTLINE PACKAGE DIMENSIONS

ON Semiconductor®



SCALE 2:1

Micro8 CASE 846A-02 ISSUE K

DATE 16 JUL 2020

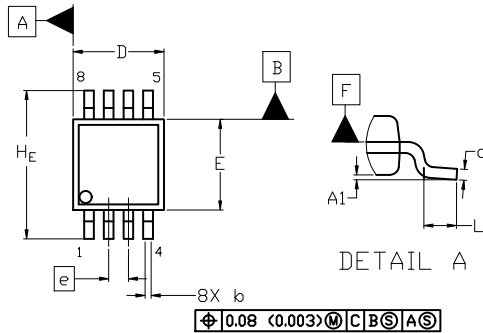

TOP VIEW

NOTE 3

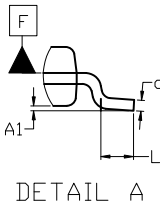

DETAIL A

$\phi 0.08$ (0.003) M C B S A S

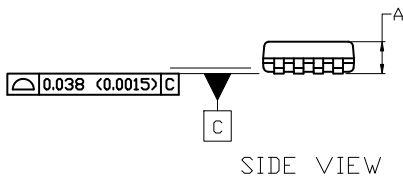

SIDE VIEW

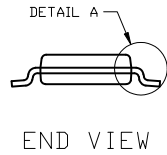

END VIEW

NOTES:

1. DIMENSIONING AND TOLERANCING PER ASME Y14.5M, 2009.
2. CONTROLLING DIMENSION: MILLIMETERS
3. DIMENSION *b* DOES NOT INCLUDE DAMBAR PROTRUSION. ALLOWABLE PROTRUSION SHALL BE 0.10 mm IN EXCESS OF MAXIMUM MATERIAL CONDITION.
4. DIMENSIONS D AND E DO NOT INCLUDE MOLD FLASH, PROTRUSION OR GATE BURRS. MOLD FLASH, PROTRUSIONS, OR GATE BURRS SHALL NOT EXCEED 0.15 mm PER SIDE. DIMENSION E DOES NOT INCLUDE INTERLEAD FLASH OR PROTRUSION. INTERLEAD FLASH OR PROTRUSION SHALL NOT EXCEED 0.25 mm PER SIDE. DIMENSIONS D AND E ARE DETERMINED AT DATUM F.
5. DATUMS A AND B ARE TO BE DETERMINED AT DATUM F.
6. A1 IS DEFINED AS THE VERTICAL DISTANCE FROM THE SEATING PLANE TO THE LOWEST POINT ON THE PACKAGE BODY.

| DIM | MILLIMETERS | | |
|----------------|-------------|------|------|
| | MIN. | NOM. | MAX. |
| A | --- | --- | 1.10 |
| A1 | 0.05 | 0.08 | 0.15 |
| <i>b</i> | 0.25 | 0.33 | 0.40 |
| <i>c</i> | 0.13 | 0.18 | 0.23 |
| D | 2.90 | 3.00 | 3.10 |
| E | 2.90 | 3.00 | 3.10 |
| <i>e</i> | 0.65 BSC | | |
| H _E | 4.75 | 4.90 | 5.05 |
| L | 0.40 | 0.55 | 0.70 |

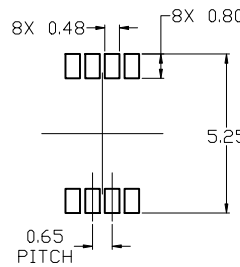

RECOMMENDED
MOUNTING FOOTPRINT

For additional information on our Pb-Free strategy and soldering details, please download the ON Semiconductor Soldering and Mounting Techniques Reference Manual, SOLDERM/D.

GENERIC MARKING DIAGRAM*

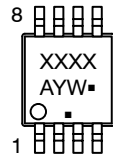

- XXXX = Specific Device Code
- A = Assembly Location
- Y = Year
- W = Work Week
- = Pb-Free Package

(Note: Microdot may be in either location)

*This information is generic. Please refer to device data sheet for actual part marking. Pb-Free indicator, "G" or microdot "▪", may or may not be present. Some products may not follow the Generic Marking.

STYLE 1:

1. SOURCE
2. SOURCE
3. SOURCE
4. GATE
5. DRAIN
6. DRAIN
7. DRAIN
8. DRAIN

STYLE 2:

1. SOURCE 1
2. GATE 1
3. SOURCE 2
4. GATE 2
5. DRAIN 2
6. DRAIN 2
7. DRAIN 1
8. DRAIN 1

STYLE 3:

1. N-SOURCE
2. N-GATE
3. P-SOURCE
4. P-GATE
5. P-DRAIN
6. P-DRAIN
7. N-DRAIN
8. N-DRAIN

| | | |
|-------------------------|--------------------|--|
| DOCUMENT NUMBER: | 98ASB14087C | Electronic versions are uncontrolled except when accessed directly from the Document Repository. Printed versions are uncontrolled except when stamped "CONTROLLED COPY" in red. |
| DESCRIPTION: | MICRO8 | PAGE 1 OF 1 |

ON Semiconductor and ON are trademarks of Semiconductor Components Industries, LLC dba ON Semiconductor or its subsidiaries in the United States and/or other countries. ON Semiconductor reserves the right to make changes without further notice to any products herein. ON Semiconductor makes no warranty, representation or guarantee regarding the suitability of its products for any particular purpose, nor does ON Semiconductor assume any liability arising out of the application or use of any product or circuit, and specifically disclaims any and all liability, including without limitation special, consequential or incidental damages. ON Semiconductor does not convey any license under its patent rights nor the rights of others.

onsemi, **Onsemi**, and other names, marks, and brands are registered and/or common law trademarks of Semiconductor Components Industries, LLC dba "**onsemi**" or its affiliates and/or subsidiaries in the United States and/or other countries. **onsemi** owns the rights to a number of patents, trademarks, copyrights, trade secrets, and other intellectual property. A listing of **onsemi**'s product/patent coverage may be accessed at www.onsemi.com/site/pdf/Patent-Marking.pdf. **onsemi** reserves the right to make changes at any time to any products or information herein, without notice. The information herein is provided "as-is" and **onsemi** makes no warranty, representation or guarantee regarding the accuracy of the information, product features, availability, functionality, or suitability of its products for any particular purpose, nor does **onsemi** assume any liability arising out of the application or use of any product or circuit, and specifically disclaims any and all liability, including without limitation special, consequential or incidental damages. Buyer is responsible for its products and applications using **onsemi** products, including compliance with all laws, regulations and safety requirements or standards, regardless of any support or applications information provided by **onsemi**. "Typical" parameters which may be provided in **onsemi** data sheets and/or specifications can and do vary in different applications and actual performance may vary over time. All operating parameters, including "Typicals" must be validated for each customer application by customer's technical experts. **onsemi** does not convey any license under any of its intellectual property rights nor the rights of others. **onsemi** products are not designed, intended, or authorized for use as a critical component in life support systems or any FDA Class 3 medical devices or medical devices with a same or similar classification in a foreign jurisdiction or any devices intended for implantation in the human body. Should Buyer purchase or use **onsemi** products for any such unintended or unauthorized application, Buyer shall indemnify and hold **onsemi** and its officers, employees, subsidiaries, affiliates, and distributors harmless against all claims, costs, damages, and expenses, and reasonable attorney fees arising out of, directly or indirectly, any claim of personal injury or death associated with such unintended or unauthorized use, even if such claim alleges that **onsemi** was negligent regarding the design or manufacture of the part. **onsemi** is an Equal Opportunity/Affirmative Action Employer. This literature is subject to all applicable copyright laws and is not for resale in any manner.

ADDITIONAL INFORMATION

TECHNICAL PUBLICATIONS:

Technical Library: www.onsemi.com/design/resources/technical-documentation
onsemi Website: www.onsemi.com

ONLINE SUPPORT: www.onsemi.com/support

For additional information, please contact your local Sales Representative at www.onsemi.com/support/sales

Looking for pricing, stock, or lifecycle information?

Click below to explore more details on WIN SOURCE:

 [View NCP3335ADM500R2G on WIN SOURCE](#)

 [ON Semiconductor](#) Information

Optimize Your Supply Chain with WIN SOURCE Solutions

-  Global Sourcing Solution
-  Obsolete Management
-  Cost Control Management
-  Shortage Management
-  Alternative Solution
-  Excess Inventory Management