



**THE DATASHEET OF  
BRL2012T330M**



## Notice for TAIYO YUDEN products

Please read this notice before using the TAIYO YUDEN products.

### ⚠️ REMINDERS

#### ■ Product Information in this Catalog

Product information in this catalog is as of January 2021. All of the contents specified herein and production status of the products listed in this catalog are subject to change without notice due to technical improvement of our products, etc. Therefore, please check for the latest information carefully before practical application or use of our products.

Please note that TAIYO YUDEN shall not be in any way responsible for any damages and defects in products or equipment incorporating our products, which are caused under the conditions other than those specified in this catalog or individual product specification sheets.

#### ■ Approval of Product Specifications

Please contact TAIYO YUDEN for further details of product specifications as the individual product specification sheets are available. When using our products, please be sure to approve our product specifications or make a written agreement on the product specification with TAIYO YUDEN in advance.

#### ■ Pre-Evaluation in the Actual Equipment and Conditions

Please conduct validation and verification of our products in actual conditions of mounting and operating environment before using our products.

#### ■ Limited Application

##### 1. Equipment Intended for Use

The products listed in this catalog are intended for general-purpose and standard use in general electronic equipment (e.g., AV equipment, OA equipment, home electric appliances, office equipment, information and communication equipment including, without limitation, mobile phone, and PC) and other equipment specified in this catalog or the individual product specification sheets.

TAIYO YUDEN has the line-up of the products intended for use in automotive electronic equipment, telecommunications infrastructure and industrial equipment, or medical devices classified as GHTF Classes A to C (Japan Classes I to III). Therefore, when using our products for these equipment, please check available applications specified in this catalog or the individual product specification sheets and use the corresponding products.

##### 2. Equipment Requiring Inquiry

Please be sure to contact TAIYO YUDEN for further information before using the products listed in this catalog for the following equipment (excluding intended equipment as specified in this catalog or the individual product specification sheets) which may cause loss of human life, bodily injury, serious property damage and/or serious public impact due to a failure or defect of the products and/or malfunction attributed thereto.

- (1) Transportation equipment (automotive powertrain control system, train control system, and ship control system, etc.)
- (2) Traffic signal equipment
- (3) Disaster prevention equipment, crime prevention equipment
- (4) Medical devices classified as GHTF Class C (Japan Class III)
- (5) Highly public information network equipment, data-processing equipment (telephone exchange, and base station, etc.)
- (6) Any other equipment requiring high levels of quality and/or reliability equal to the equipment listed above

##### 3. Equipment Prohibited for Use

Please do not incorporate our products into the following equipment requiring extremely high levels of safety and/or reliability.

- (1) Aerospace equipment (artificial satellite, rocket, etc.)
- (2) Aviation equipment \*<sup>1</sup>
- (3) Medical devices classified as GHTF Class D (Japan Class IV), implantable medical devices \*<sup>2</sup>

- (4) Power generation control equipment (nuclear power, hydroelectric power, thermal power plant control system, etc.)
- (5) Undersea equipment (submarine repeating equipment, underwater work equipment, etc.)
- (6) Military equipment
- (7) Any other equipment requiring extremely high levels of safety and/or reliability equal to the equipment listed above

\*Notes:

1. There is a possibility that our products can be used only for aviation equipment that does not directly affect the safe operation of aircraft (e.g., in-flight entertainment, cabin light, electric seat, cooking equipment) if such use meets requirements specified separately by TAIYO YUDEN. Please be sure to contact TAIYO YUDEN for further information before using our products for such aviation equipment.
2. Implantable medical devices contain not only internal unit which is implanted in a body, but also external unit which is connected to the internal unit.

#### 4. Limitation of Liability

Please note that unless you obtain prior written consent of TAIYO YUDEN, TAIYO YUDEN shall not be in any way responsible for any damages incurred by you or third parties arising from use of the products listed in this catalog for any equipment that is not intended for use by TAIYO YUDEN, or any equipment requiring inquiry to TAIYO YUDEN or prohibited for use by TAIYO YUDEN as described above.

#### ■ Safety Design

When using our products for high safety and/or reliability-required equipment or circuits, please fully perform safety and/or reliability evaluation. In addition, please install (i) systems equipped with a protection circuit and a protection device and/or (ii) systems equipped with a redundant circuit or other system to prevent an unsafe status in the event of a single fault for a failsafe design to ensure safety.

#### ■ Intellectual Property Rights

Information contained in this catalog is intended to convey examples of typical performances and/or applications of our products and is not intended to make any warranty with respect to the intellectual property rights or any other related rights of TAIYO YUDEN or any third parties nor grant any license under such rights.

#### ■ Limited Warranty

Please note that the scope of warranty for our products is limited to the delivered our products themselves and TAIYO YUDEN shall not be in any way responsible for any damages resulting from a failure or defect in our products. Notwithstanding the foregoing, if there is a written agreement (e.g., supply and purchase agreement, quality assurance agreement) signed by TAIYO YUDEN and your company, TAIYO YUDEN will warrant our products in accordance with such agreement.

#### ■ TAIYO YUDEN's Official Sales Channel

The contents of this catalog are applicable to our products which are purchased from our sales offices or authorized distributors (hereinafter "TAIYO YUDEN's official sales channel"). Please note that the contents of this catalog are not applicable to our products purchased from any seller other than TAIYO YUDEN's official sales channel.

#### ■ Caution for Export

Some of our products listed in this catalog may require specific procedures for export according to "U.S. Export Administration Regulations", "Foreign Exchange and Foreign Trade Control Law" of Japan, and other applicable regulations. Should you have any questions on this matter, please contact our sales staff.

▶ This catalog contains the typical specification only due to the limitation of space. When you consider the purchase of our products, please check our product specification sheets. For details of each product (characteristics graph, reliability information, precautions for use, and so on), see our website (<http://www.ty-top.com/>).

## WIRE-WOUND CHIP POWER INDUCTORS (BR SERIES)

REFLOW

PARTS NUMBER

\* Operating Temp.: -40~+105°C (Including self-generated heat)

|   |   |   |   |   |   |   |   |   |   |   |   |   |   |   |   |
|---|---|---|---|---|---|---|---|---|---|---|---|---|---|---|---|
| B | R | △ | L | 2 | 5 | 1 | 8 | T | 2 | R | 2 | M | △ | △ | △ |
| ① | ② | ③ | ④ | ⑤ | ⑥ | ⑦ |   |   |   |   |   |   |   |   |   |

△=Blank space

## ① Series name

| Code | Series name                    |
|------|--------------------------------|
| BR   | Wire-Wound chip power inductor |

## ② Characteristics

| Code | Characteristics |
|------|-----------------|
| FL   | Low profile     |
| △L   |                 |
| HL   |                 |
| △C   | High current    |

## ③ Dimensions (L × W)

| Code | Type (inch) | Dimensions (L × W) [mm] |
|------|-------------|-------------------------|
| 1608 | 1608(0603)  | 1.6 × 0.8               |
| 2012 | 2012(0805)  | 2.0 × 1.25              |
| 2016 | 2016(0806)  | 2.0 × 1.6               |
| 2518 | 2518(1007)  | 2.5 × 1.8               |
| 3225 | 3225(1210)  | 3.2 × 2.5               |

## ④ Packaging

| Code | Packaging |
|------|-----------|
| T    | Taping    |

## ⑤ Nominal inductance

| Code (example) | Nominal inductance [μH] |
|----------------|-------------------------|
| R20            | 0.2                     |
| 1R0            | 1.0                     |
| 100            | 10                      |
| 101            | 100                     |

※R=Decimal point

## ⑥ Inductance tolerance

| Code | Inductance tolerance |
|------|----------------------|
| K    | ±10%                 |
| M    | ±20%                 |

## ⑦ Internal code

## STANDARD EXTERNAL DIMENSIONS / STANDARD QUANTITY

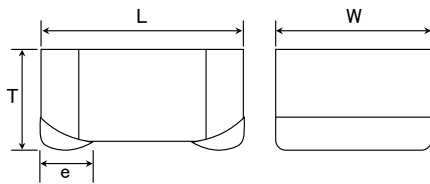

## Recommended Land Patterns

## Surface Mounting

- Mounting and soldering conditions should be checked beforehand.
- Applicable soldering process to these products is reflow soldering only.

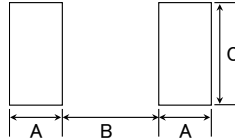

| Type | A    | B    | C    |
|------|------|------|------|
| 1608 | 0.55 | 0.70 | 1.00 |
| 2012 | 0.60 | 1.00 | 1.45 |
| 2016 | 0.60 | 1.00 | 1.80 |
| 2518 | 0.60 | 1.50 | 2.00 |
| 3225 | 0.85 | 1.70 | 2.70 |

Unit: mm

| Type     | L                        | W                         | T                        | e                          | Standard quantity [pcs] |               |
|----------|--------------------------|---------------------------|--------------------------|----------------------------|-------------------------|---------------|
|          |                          |                           |                          |                            | Paper tape              | Embossed tape |
| BR L1608 | 1.6±0.2<br>(0.063±0.008) | 0.8±0.2<br>(0.031±0.008)  | 0.7 max<br>(0.028 max)   | 0.45±0.15<br>(0.016±0.006) | —                       | 3000          |
| BR C1608 | 1.6±0.2<br>(0.063±0.008) | 0.8±0.2<br>(0.031±0.008)  | 0.8±0.2<br>(0.031±0.008) | 0.45±0.15<br>(0.016±0.006) | —                       | 3000          |
| BR L2012 | 2.0±0.2<br>(0.079±0.008) | 1.25±0.2<br>(0.049±0.008) | 1.0 max<br>(0.040 max)   | 0.5±0.2<br>(0.020±0.008)   | —                       | 3000          |
| BR C2012 | 2.0±0.2<br>(0.079±0.008) | 1.25±0.2<br>(0.049±0.008) | 1.4 max<br>(0.056 max)   | 0.5±0.2<br>(0.020±0.008)   | —                       | 2000          |
| BR C2016 | 2.0±0.2<br>(0.079±0.008) | 1.6±0.2<br>(0.063±0.008)  | 1.6±0.2<br>(0.063±0.008) | 0.5±0.2<br>(0.020±0.008)   | —                       | 2000          |
| BRFL2518 | 2.5±0.2<br>(0.098±0.008) | 1.8±0.2<br>(0.071±0.008)  | 1.0 max<br>(0.040 max)   | 0.5±0.2<br>(0.020±0.008)   | —                       | 3000          |
| BR L2518 | 2.5±0.2<br>(0.098±0.008) | 1.8±0.2<br>(0.071±0.008)  | 1.2 max<br>(0.048 max)   | 0.5±0.2<br>(0.020±0.008)   | —                       | 3000          |
| BRHL2518 | 2.5±0.2<br>(0.098±0.008) | 1.8±0.2<br>(0.071±0.008)  | 1.5 max<br>(0.060 max)   | 0.5±0.2<br>(0.020±0.008)   | —                       | 2000          |
| BR C2518 | 2.5±0.2<br>(0.098±0.008) | 1.8±0.2<br>(0.071±0.008)  | 1.8±0.2<br>(0.071±0.008) | 0.5±0.2<br>(0.020±0.008)   | —                       | 2000          |
| BR L3225 | 3.2±0.2<br>(0.126±0.008) | 2.5±0.2<br>(0.098±0.008)  | 1.7 max<br>(0.068 max)   | 0.75±0.2<br>(0.03±0.008)   | —                       | 2000          |

Unit: mm (inch)

► This catalog contains the typical specification only due to the limitation of space. When you consider the purchase of our products, please check our product specification sheets. For details of each product (characteristics graph, reliability information, precautions for use, and so on), see our website (<http://www.ty-top.com/>).

## PARTS NUMBER

### 1608 (0603) type

| Parts number  | EHS  | Nominal inductance [μH] | Inductance tolerance | Self-resonant frequency [MHz] (min.) | DC Resistance [Ω] (±30%) | Rated current ※) [mA]   |                               | Measuring frequency [MHz] |
|---------------|------|-------------------------|----------------------|--------------------------------------|--------------------------|-------------------------|-------------------------------|---------------------------|
|               |      |                         |                      |                                      |                          | Saturation current Idc1 | Temperature rise current Idc2 |                           |
| BR L1608T1R0M | RoHS | 1.0                     | ±20%                 | 700                                  | 0.230                    | 510                     | 650                           | 1.0                       |
| BR L1608T1R5M | RoHS | 1.5                     | ±20%                 | 600                                  | 0.280                    | 440                     | 590                           | 1.0                       |
| BR L1608T2R2M | RoHS | 2.2                     | ±20%                 | 400                                  | 0.400                    | 360                     | 500                           | 1.0                       |
| BR L1608T3R3M | RoHS | 3.3                     | ±20%                 | 300                                  | 0.650                    | 290                     | 390                           | 1.0                       |
| BR L1608T4R7M | RoHS | 4.7                     | ±20%                 | 150                                  | 1.00                     | 240                     | 310                           | 1.0                       |
| BR L1608T6R8M | RoHS | 6.8                     | ±20%                 | 100                                  | 1.64                     | 200                     | 250                           | 1.0                       |
| BR L1608T100M | RoHS | 10                      | ±20%                 | 45                                   | 2.00                     | 170                     | 220                           | 1.0                       |
| BR L1608T150M | RoHS | 15                      | ±20%                 | 32                                   | 2.56                     | 150                     | 200                           | 1.0                       |

| Parts number    | EHS  | Nominal inductance [μH] | Inductance tolerance | Self-resonant frequency [MHz] (min.) | DC Resistance [Ω] (±30%) | Rated current ※) [mA]   |                               | Measuring frequency [MHz] |
|-----------------|------|-------------------------|----------------------|--------------------------------------|--------------------------|-------------------------|-------------------------------|---------------------------|
|                 |      |                         |                      |                                      |                          | Saturation current Idc1 | Temperature rise current Idc2 |                           |
| BR C1608TR43M 6 | RoHS | 0.43                    | ±20%                 | 740                                  | 0.082                    | 1,400                   | 1,100                         | 6.0                       |
| BR C1608TR50M 6 | RoHS | 0.50                    | ±20%                 | 710                                  | 0.090                    | 1,200                   | 1,050                         | 6.0                       |
| BR C1608TR60M 6 | RoHS | 0.60                    | ±20%                 | 630                                  | 0.099                    | 1,100                   | 940                           | 6.0                       |
| BR C1608TR72M 6 | RoHS | 0.72                    | ±20%                 | 600                                  | 0.144                    | 1,000                   | 810                           | 6.0                       |
| BR C1608TR82M 6 | RoHS | 0.82                    | ±20%                 | 560                                  | 0.176                    | 950                     | 730                           | 6.0                       |
| BR C1608T1R0M 6 | RoHS | 1.0                     | ±20%                 | 550                                  | 0.188                    | 890                     | 680                           | 6.0                       |

| Parts number  | EHS  | Nominal inductance [μH] | Inductance tolerance | Self-resonant frequency [MHz] (min.) | DC Resistance [Ω] (±30%) | Rated current ※) [mA]   |                               | Measuring frequency [MHz] |
|---------------|------|-------------------------|----------------------|--------------------------------------|--------------------------|-------------------------|-------------------------------|---------------------------|
|               |      |                         |                      |                                      |                          | Saturation current Idc1 | Temperature rise current Idc2 |                           |
| BR C1608TR20M | RoHS | 0.20                    | ±20%                 | 400                                  | 0.060                    | 1,750                   | 980                           | 7.96                      |
| BR C1608TR35M | RoHS | 0.35                    | ±20%                 | 300                                  | 0.080                    | 1,400                   | 810                           | 7.96                      |
| BR C1608TR45M | RoHS | 0.45                    | ±20%                 | 200                                  | 0.090                    | 1,250                   | 800                           | 7.96                      |
| BR C1608TR56M | RoHS | 0.56                    | ±20%                 | 170                                  | 0.095                    | 1,150                   | 760                           | 7.96                      |
| BR C1608TR77M | RoHS | 0.77                    | ±20%                 | 150                                  | 0.110                    | 1,000                   | 660                           | 7.96                      |
| BR C1608T1R0M | RoHS | 1.0                     | ±20%                 | 140                                  | 0.180                    | 850                     | 520                           | 7.96                      |
| BR C1608T1R5M | RoHS | 1.5                     | ±20%                 | 120                                  | 0.300                    | 700                     | 410                           | 7.96                      |
| BR C1608T2R2M | RoHS | 2.2                     | ±20%                 | 100                                  | 0.550                    | 550                     | 280                           | 7.96                      |

### 2012 (0805) type

| Parts number    | EHS  | Nominal inductance [μH] | Inductance tolerance | Self-resonant frequency [MHz] (min.) | DC Resistance [Ω] (±30%) | Rated current ※) [mA]   |                               | Measuring frequency [MHz] |
|-----------------|------|-------------------------|----------------------|--------------------------------------|--------------------------|-------------------------|-------------------------------|---------------------------|
|                 |      |                         |                      |                                      |                          | Saturation current Idc1 | Temperature rise current Idc2 |                           |
| BR L2012TR47M 6 | RoHS | 0.47                    | ±20%                 | 500                                  | 0.048                    | 1,500                   | 1,900                         | 6.0                       |
| BR L2012T1R0M 6 | RoHS | 1.0                     | ±20%                 | 400                                  | 0.108                    | 1,050                   | 1,230                         | 6.0                       |
| BR L2012T2R2MD6 | RoHS | 2.2                     | ±20%                 | 250                                  | 0.184                    | 680                     | 950                           | 6.0                       |

| Parts number  | EHS  | Nominal inductance [μH] | Inductance tolerance | Self-resonant frequency [MHz] (min.) | DC Resistance [Ω] (±30%) | Rated current ※) [mA]   |                               | Measuring frequency [MHz] |
|---------------|------|-------------------------|----------------------|--------------------------------------|--------------------------|-------------------------|-------------------------------|---------------------------|
|               |      |                         |                      |                                      |                          | Saturation current Idc1 | Temperature rise current Idc2 |                           |
| BR L2012TR47M | RoHS | 0.47                    | ±20%                 | 350                                  | 0.090                    | 1,100                   | 1,050                         | 7.96                      |
| BR L2012T1R0M | RoHS | 1.0                     | ±20%                 | 300                                  | 0.135                    | 850                     | 850                           | 7.96                      |
| BR L2012T1R5M | RoHS | 1.5                     | ±20%                 | 250                                  | 0.180                    | 700                     | 750                           | 7.96                      |
| BR L2012T2R2M | RoHS | 2.2                     | ±20%                 | 200                                  | 0.300                    | 600                     | 550                           | 7.96                      |
| BR L2012T3R3M | RoHS | 3.3                     | ±20%                 | 190                                  | 0.500                    | 490                     | 440                           | 7.96                      |
| BR L2012T4R7M | RoHS | 4.7                     | ±20%                 | 150                                  | 0.550                    | 340                     | 400                           | 7.96                      |
| BR L2012T6R8M | RoHS | 6.8                     | ±20%                 | 60                                   | 0.750                    | 290                     | 350                           | 7.96                      |
| BR L2012T100M | RoHS | 10                      | ±20%                 | 30                                   | 0.850                    | 270                     | 330                           | 2.52                      |
| BR L2012T150M | RoHS | 15                      | ±20%                 | 15                                   | 1.00                     | 220                     | 300                           | 2.52                      |
| BR L2012T220M | RoHS | 22                      | ±20%                 | 13                                   | 1.30                     | 190                     | 270                           | 2.52                      |
| BR L2012T330M | RoHS | 33                      | ±20%                 | 8.0                                  | 2.00                     | 150                     | 220                           | 2.52                      |
| BR L2012T470M | RoHS | 47                      | ±20%                 | 7.0                                  | 3.50                     | 125                     | 160                           | 2.52                      |
| BR L2012T680M | RoHS | 68                      | ±20%                 | 6.5                                  | 5.80                     | 100                     | 110                           | 2.52                      |
| BR L2012T101M | RoHS | 100                     | ±20%                 | 6.0                                  | 7.70                     | 85                      | 85                            | 0.796                     |

| Parts number   | EHS  | Nominal inductance [μH] | Inductance tolerance | Self-resonant frequency [MHz] (min.) | DC Resistance [Ω] (±30%) | Rated current ※) [mA]   |                               | Measuring frequency [MHz] |
|----------------|------|-------------------------|----------------------|--------------------------------------|--------------------------|-------------------------|-------------------------------|---------------------------|
|                |      |                         |                      |                                      |                          | Saturation current Idc1 | Temperature rise current Idc2 |                           |
| BR C2012T1R0M  | RoHS | 1.0                     | ±20%                 | 490                                  | 0.060                    | 1,500                   | 1,400                         | 1.0                       |
| BR C2012T1R5MD | RoHS | 1.5                     | ±20%                 | 390                                  | 0.090                    | 1,200                   | 1,100                         | 1.0                       |
| BR C2012T2R2MD | RoHS | 2.2                     | ±20%                 | 350                                  | 0.110                    | 1,100                   | 1,000                         | 1.0                       |
| BR C2012T3R3MD | RoHS | 3.3                     | ±20%                 | 300                                  | 0.170                    | 800                     | 870                           | 1.0                       |
| BR C2012T4R7MD | RoHS | 4.7                     | ±20%                 | 250                                  | 0.265                    | 700                     | 600                           | 1.0                       |

※) The saturation current value (Idc1) is the DC current value having inductance decrease down to 30%. (at 20°C)

※) The temperature rise current value (Idc2) is the DC current value having temperature increase by 40°C. (at 20°C)

※) The rated current value is following either Idc1 or Idc2, which is the lower one.

■ PARTS NUMBER

● 2016 (0806) type

| Parts number  | EHS  | Nominal inductance<br>[μH] | Inductance tolerance | Self-resonant<br>frequency<br>[MHz] (min.) | DC Resistance<br>[Ω] (±30%) | Rated current ※) [mA]      |                                  | Measuring<br>frequency [MHz] |
|---------------|------|----------------------------|----------------------|--|-----------------------------|----------------------------|----------------------------------|------------------------------|
|               |      |                            |                      |  |                             | Saturation current<br>Idc1 | Temperature rise current<br>Idc2 |                              |
| BR C2016T1R0M | RoHS | 1.0                        | ±20%                 | 450  | 0.085                       | 1,350                      | 1,100                            | 0.10                         |
| BR C2016T1R5M | RoHS | 1.5                        | ±20%                 | 370  | 0.150                       | 1,100                      | 820                              | 0.10                         |
| BR C2016T2R2M | RoHS | 2.2                        | ±20%                 | 250  | 0.180                       | 910                        | 760                              | 0.10                         |
| BR C2016T3R3M | RoHS | 3.3                        | ±20%                 | 140  | 0.220                       | 740                        | 680                              | 0.10                         |
| BR C2016T4R7M | RoHS | 4.7                        | ±20%                 | 78   | 0.270                       | 660                        | 610                              | 0.10                         |
| BR C2016T6R8M | RoHS | 6.8                        | ±20%                 | 39   | 0.330                       | 550                        | 560                              | 0.10                         |
| BR C2016T100□ | RoHS | 10                         | ±10%, ±20%           | 35   | 0.400                       | 450                        | 520                              | 0.10                         |
| BR C2016T150□ | RoHS | 15                         | ±10%, ±20%           | 28   | 0.600                       | 400                        | 410                              | 0.10                         |
| BR C2016T220□ | RoHS | 22                         | ±10%, ±20%           | 24   | 1.00                        | 310                        | 310                              | 0.10                         |
| BR C2016T330□ | RoHS | 33                         | ±10%, ±20%           | 13   | 1.70                        | 270                        | 240                              | 0.10                         |
| BR C2016T470□ | RoHS | 47                         | ±10%, ±20%           | 11   | 2.20                        | 210                        | 210                              | 0.10                         |
| BR C2016T680□ | RoHS | 68                         | ±10%, ±20%           | 8  | 2.80                        | 200                        | 190                              | 0.10                         |
| BR C2016T101□ | RoHS | 100                        | ±10%, ±20%           | 7  | 3.40                        | 140                        | 170                              | 0.10                         |

● 2518 (1007) type

| Parts number  | EHS  | Nominal inductance<br>[μH] | Inductance tolerance | Self-resonant<br>frequency<br>[MHz] (min.) | DC Resistance<br>[Ω] (±30%) | Rated current ※) [mA]      |                                  | Measuring<br>frequency [MHz] |
|---------------|------|----------------------------|----------------------|--|-----------------------------|----------------------------|----------------------------------|------------------------------|
|               |      |                            |                      |  |                             | Saturation current<br>Idc1 | Temperature rise current<br>Idc2 |                              |
| BRFL2518T1R0M | RoHS | 1.0                        | ±20%                 | 130  | 0.090                       | 1,200                      | 1,200                            | 1.0                          |
| BRFL2518T1R5M | RoHS | 1.5                        | ±20%                 | 100  | 0.110                       | 1,100                      | 1,000                            | 1.0                          |
| BRFL2518T2R2M | RoHS | 2.2                        | ±20%                 | 80   | 0.130                       | 850                        | 950                              | 1.0                          |
| BRFL2518T3R3M | RoHS | 3.3                        | ±20%                 | 70   | 0.220                       | 700                        | 700                              | 1.0                          |
| BRFL2518T4R7M | RoHS | 4.7                        | ±20%                 | 60   | 0.330                       | 650                        | 650                              | 1.0                          |

| Parts number  | EHS  | Nominal inductance<br>[μH] | Inductance tolerance | Self-resonant<br>frequency<br>[MHz] (min.) | DC Resistance<br>[Ω] (±30%) | Rated current ※) [mA]      |                                  | Measuring<br>frequency [MHz] |
|---------------|------|----------------------------|----------------------|--|-----------------------------|----------------------------|----------------------------------|------------------------------|
|               |      |                            |                      |  |                             | Saturation current<br>Idc1 | Temperature rise current<br>Idc2 |                              |
| BR L2518T1R0M | RoHS | 1.0                        | ±20%                 | 130  | 0.080                       | 1,600                      | 1,000                            | 7.96                         |
| BR L2518T1R5M | RoHS | 1.5                        | ±20%                 | 100  | 0.100                       | 1,200                      | 920                              | 7.96                         |
| BR L2518T2R2M | RoHS | 2.2                        | ±20%                 | 80   | 0.135                       | 1,000                      | 850                              | 7.96                         |
| BR L2518T3R3M | RoHS | 3.3                        | ±20%                 | 70   | 0.300                       | 800                        | 580                              | 7.96                         |
| BR L2518T4R7M | RoHS | 4.7                        | ±20%                 | 60   | 0.400                       | 700                        | 470                              | 7.96                         |

| Parts number   | EHS  | Nominal inductance<br>[μH] | Inductance tolerance | Self-resonant<br>frequency<br>[MHz] (min.) | DC Resistance<br>[Ω] (±30%) | Rated current ※) [mA]      |                                  | Measuring<br>frequency [MHz] |
|----------------|------|----------------------------|----------------------|--|-----------------------------|----------------------------|----------------------------------|------------------------------|
|                |      |                            |                      |  |                             | Saturation current<br>Idc1 | Temperature rise current<br>Idc2 |                              |
| BRHL2518T1R0M  | RoHS | 1.0                        | ±20%                 | 400  | 0.055                       | 2,000                      | 1,400                            | 1.0                          |
| BRHL2518T1R5M  | RoHS | 1.5                        | ±20%                 | 350  | 0.085                       | 1,700                      | 1,100                            | 1.0                          |
| BRHL2518T2R2M  | RoHS | 2.2                        | ±20%                 | 300  | 0.115                       | 1,500                      | 1,000                            | 1.0                          |
| BRHL2518T3R3MD | RoHS | 3.3                        | ±20%                 | 200  | 0.165                       | 1,200                      | 800                              | 1.0                          |
| BRHL2518T4R7MD | RoHS | 4.7                        | ±20%                 | 150  | 0.245                       | 1,100                      | 750                              | 1.0                          |

| Parts number  | EHS  | Nominal inductance<br>[μH] | Inductance tolerance | Self-resonant<br>frequency<br>[MHz] (min.) | DC Resistance<br>[Ω] (±30%) | Rated current ※) [mA]      |                                  | Measuring<br>frequency [MHz] |
|---------------|------|----------------------------|----------------------|--|-----------------------------|----------------------------|----------------------------------|------------------------------|
|               |      |                            |                      |  |                             | Saturation current<br>Idc1 | Temperature rise current<br>Idc2 |                              |
| BR C2518T1R0M | RoHS | 1.0                        | ±20%                 | 280  | 0.050                       | 2,550                      | 1,650                            | 1.0                          |
| BR C2518T1R5M | RoHS | 1.5                        | ±20%                 | 230  | 0.080                       | 2,100                      | 1,300                            | 1.0                          |
| BR C2518T2R2M | RoHS | 2.2                        | ±20%                 | 200  | 0.120                       | 1,800                      | 1,000                            | 1.0                          |
| BR C2518T3R3M | RoHS | 3.3                        | ±20%                 | 150  | 0.175                       | 1,450                      | 860                              | 1.0                          |
| BR C2518T4R7M | RoHS | 4.7                        | ±20%                 | 100  | 0.230                       | 1,250                      | 750                              | 1.0                          |
| BR C2518T6R8M | RoHS | 6.8                        | ±20%                 | 45   | 0.280                       | 1,050                      | 680                              | 1.0                          |
| BR C2518T100□ | RoHS | 10                         | ±10%, ±20%           | 20   | 0.350                       | 890                        | 610                              | 1.0                          |
| BR C2518T150□ | RoHS | 15                         | ±10%, ±20%           | 13   | 0.430                       | 760                        | 550                              | 1.0                          |
| BR C2518T220□ | RoHS | 22                         | ±10%, ±20%           | 10   | 0.560                       | 640                        | 490                              | 1.0                          |
| BR C2518T330□ | RoHS | 33                         | ±10%, ±20%           | 8  | 0.850                       | 560                        | 390                              | 1.0                          |
| BR C2518T470□ | RoHS | 47                         | ±10%, ±20%           | 6.5  | 1.45                        | 410                        | 300                              | 1.0                          |
| BR C2518T680□ | RoHS | 68                         | ±10%, ±20%           | 5.5  | 2.40                        | 340                        | 230                              | 1.0                          |
| BR C2518T101□ | RoHS | 100                        | ±10%, ±20%           | 4.5  | 3.60                        | 300                        | 190                              | 1.0                          |

□ Please specify the inductance tolerance code. (M or K)

※) The saturation current value (Idc1) is the DC current value having inductance decrease down to 30%. (at 20°C)

※) The temperature rise current value (Idc2) is the DC current value having temperature increase by 40°C. (at 20°C)

※) The rated current value is following either Idc1 or Idc2, which is the lower one.

## PARTS NUMBER

### 3225 (1210) type

| Parts number  | EHS  | Nominal inductance<br>[ $\mu$ H] | Inductance tolerance | Self-resonant<br>frequency<br>[MHz] (min.) | DC Resistance<br>[ $\Omega$ ] ( $\pm 30\%$ ) | Rated current ※) [mA]      |                                  | Measuring<br>frequency [MHz] |
|---------------|------|----------------------------------|----------------------|--|--|----------------------------|----------------------------------|------------------------------|
|               |      |                                  |                      |  |  | Saturation current<br>Idc1 | Temperature rise current<br>Idc2 |                              |
| BR L3225TR27M | RoHS | 0.27                             | $\pm 20\%$           | 390  | 0.022  | 4,500                      | 2,850                            | 7.96                         |
| BR L3225TR36M | RoHS | 0.36                             | $\pm 20\%$           | 350  | 0.025  | 4,300                      | 2,750                            | 7.96                         |
| BR L3225TR51M | RoHS | 0.51                             | $\pm 20\%$           | 270  | 0.029  | 3,600                      | 2,550                            | 7.96                         |

| Parts number  | EHS  | Nominal inductance<br>[ $\mu$ H] | Inductance tolerance    | Self-resonant<br>frequency<br>[MHz] (min.) | DC Resistance<br>[ $\Omega$ ] ( $\pm 20\%$ ) | Rated current ※) [mA]      |                                  | Measuring<br>frequency [MHz] |
|---------------|------|----------------------------------|-------------------------|--|--|----------------------------|----------------------------------|------------------------------|
|               |      |                                  |                         |  |  | Saturation current<br>Idc1 | Temperature rise current<br>Idc2 |                              |
| BR L3225T1R0M | RoHS | 1.0                              | $\pm 20\%$              | 220  | 0.043  | 2,400                      | 2,200                            | 0.1                          |
| BR L3225T1R5M | RoHS | 1.5                              | $\pm 20\%$              | 170  | 0.045  | 2,200                      | 1,750                            | 0.1                          |
| BR L3225T2R2M | RoHS | 2.2                              | $\pm 20\%$              | 150  | 0.065  | 1,850                      | 1,600                            | 0.1                          |
| BR L3225T3R3M | RoHS | 3.3                              | $\pm 20\%$              | 140  | 0.120  | 1,450                      | 1,200                            | 0.1                          |
| BR L3225T4R7M | RoHS | 4.7                              | $\pm 20\%$              | 120  | 0.180  | 1,300                      | 1,000                            | 0.1                          |
| BR L3225T6R8M | RoHS | 6.8                              | $\pm 20\%$              | 90   | 0.270  | 1,050                      | 770                              | 0.1                          |
| BR L3225T100□ | RoHS | 10                               | $\pm 10\%$ , $\pm 20\%$ | 70   | 0.350  | 900                        | 700                              | 0.1                          |
| BR L3225T150□ | RoHS | 15                               | $\pm 10\%$ , $\pm 20\%$ | 20   | 0.570  | 700                        | 530                              | 0.1                          |
| BR L3225T220□ | RoHS | 22                               | $\pm 10\%$ , $\pm 20\%$ | 13   | 0.690  | 550                        | 470                              | 0.1                          |
| BR L3225T330□ | RoHS | 33                               | $\pm 10\%$ , $\pm 20\%$ | 9  | 0.840  | 470                        | 420                              | 0.1                          |
| BR L3225T470□ | RoHS | 47                               | $\pm 10\%$ , $\pm 20\%$ | 7  | 1.00   | 420                        | 390                              | 0.1                          |
| BR L3225T680□ | RoHS | 68                               | $\pm 10\%$ , $\pm 20\%$ | 6  | 1.40   | 330                        | 300                              | 0.1                          |
| BR L3225T101□ | RoHS | 100                              | $\pm 10\%$ , $\pm 20\%$ | 5  | 2.50   | 270                        | 250                              | 0.1                          |

□ Please specify the inductance tolerance code. (M or K)

※) The saturation current value (Idc1) is the DC current value having inductance decrease down to 30%. (at 20°C)

※) The temperature rise current value (Idc2) is the DC current value having temperature increase by 40°C. (at 20°C)

※) The rated current value is following either Idc1 or Idc2, which is the lower one.

# WIRE-WOUND CHIP POWER INDUCTORS (BR SERIES)

## PACKAGING

### ① Minimum Quantity

| Type     | Standard Quantity [pcs] |               |
|----------|-------------------------|---------------|
|          | Paper Tape              | Embossed Tape |
| BR C1608 | —                       | 3,000         |
| BR L1608 | —                       | 3,000         |
| BR L2012 | —                       | 3,000         |
| BR C2012 | —                       | 2,000         |
| BR C2016 | —                       | 2,000         |
| BR C2518 | —                       | 2,000         |
| BRHL2518 | —                       | 2,000         |
| BR L2518 | —                       | 3,000         |
| BRFL2518 | —                       | 3,000         |
| BR L3225 | —                       | 2,000         |

### ② Tape Material

#### ● Embossed tape

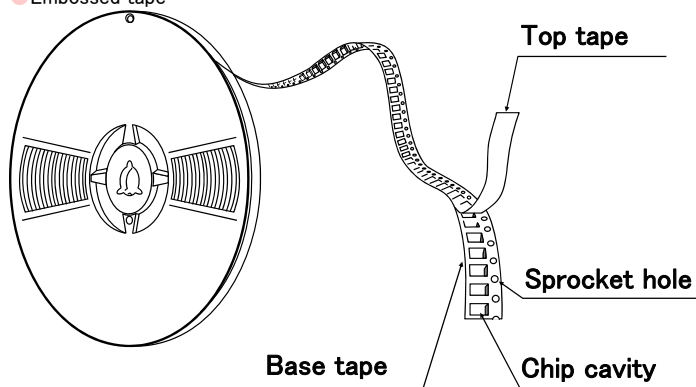

#### Chip Filled

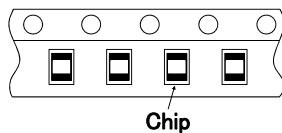

### ③ Taping dimensions

#### ● Embossed Tape 8mm wide (0.315 inches wide)

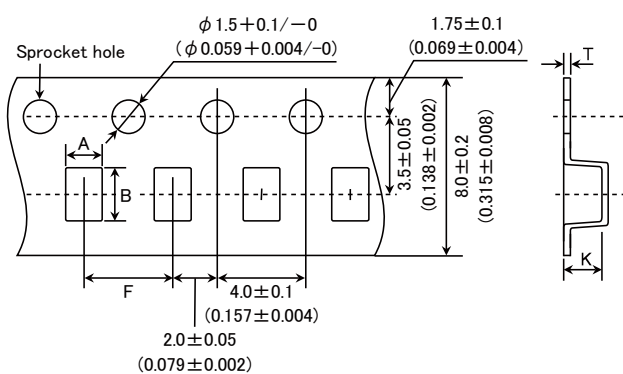

▶ This catalog contains the typical specification only due to the limitation of space. When you consider the purchase of our products, please check our specification. For details of each product (characteristics graph, reliability information, precautions for use, and so on), see our Web site (<http://www.ty-top.com/>).

| Type     | Chip cavity               |                           | Insertion pitch          | Tape thickness             |                         |
|----------|---------------------------|---------------------------|--------------------------|----------------------------|-------------------------|
|          | A                         | B                         | F                        | T                          | K                       |
| BR L1608 | 1.1±0.1<br>(0.043±0.004)  | 1.9±0.1<br>(0.075±0.004)  | 4.0±0.1<br>(0.157±0.004) | 0.2±0.05<br>(0.008±0.002)  | 0.9 max<br>(0.035 max)  |
| BR C1608 | 1.1±0.1<br>(0.043±0.004)  | 1.9±0.1<br>(0.075±0.004)  | 4.0±0.1<br>(0.157±0.004) | 0.25±0.05<br>(0.010±0.002) | 1.2 max<br>(0.047 max)  |
| BR L2012 | 1.45±0.1<br>(0.057±0.004) | 2.2±0.1<br>(0.087±0.004)  | 4.0±0.1<br>(0.157±0.004) | 0.25±0.05<br>(0.010±0.002) | 1.2 max<br>(0.047 max)  |
| BR C2012 | 1.45±0.1<br>(0.057±0.004) | 2.37±0.1<br>(0.093±0.004) | 4.0±0.1<br>(0.157±0.004) | 0.25±0.05<br>(0.010±0.002) | 1.59 max<br>(0.063 max) |
| BR C2016 | 1.75±0.1<br>(0.069±0.004) | 2.1±0.1<br>(0.083±0.004)  | 4.0±0.1<br>(0.157±0.004) | 0.3±0.05<br>(0.012±0.002)  | 1.9 max<br>(0.075 max)  |
| BRFL2518 | 2.3±0.1<br>(0.091±0.004)  | 2.8±0.1<br>(0.110±0.004)  | 4.0±0.1<br>(0.157±0.004) | 0.25±0.05<br>(0.010±0.002) | 1.3 max<br>(0.051 max)  |
| BR L2518 | 2.3±0.1<br>(0.091±0.004)  | 2.8±0.1<br>(0.110±0.004)  | 4.0±0.1<br>(0.157±0.004) | 0.3±0.05<br>(0.012±0.002)  | 1.45 max<br>(0.057 max) |
| BRHL2518 | 2.1±0.1<br>(0.083±0.004)  | 2.8±0.1<br>(0.110±0.004)  | 4.0±0.1<br>(0.157±0.004) | 0.3±0.05<br>(0.012±0.002)  | 1.7 max<br>(0.067 max)  |
| BR C2518 | 2.15±0.1<br>(0.085±0.004) | 2.7±0.1<br>(0.106±0.004)  | 4.0±0.1<br>(0.157±0.004) | 0.3±0.05<br>(0.012±0.002)  | 2.2 max<br>(0.087 max)  |
| BR L3225 | 2.8±0.1<br>(0.110±0.004)  | 3.5±0.1<br>(0.138±0.004)  | 4.0±0.1<br>(0.157±0.004) | 0.25±0.05<br>(0.010±0.002) | 1.9 max<br>(0.075 max)  |

Unit: mm (inch)

#### ④ Leader and Blank portion

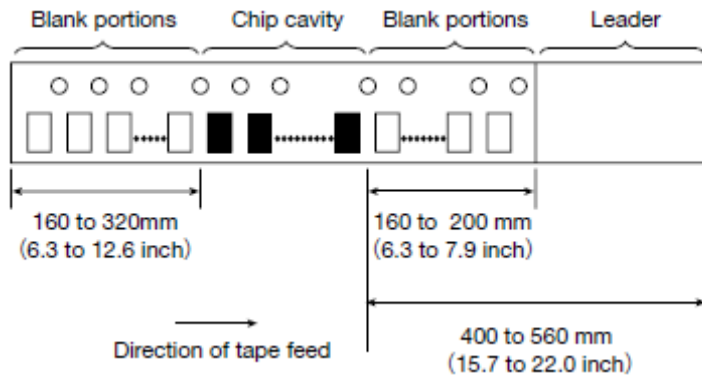

#### ⑤ Reel size

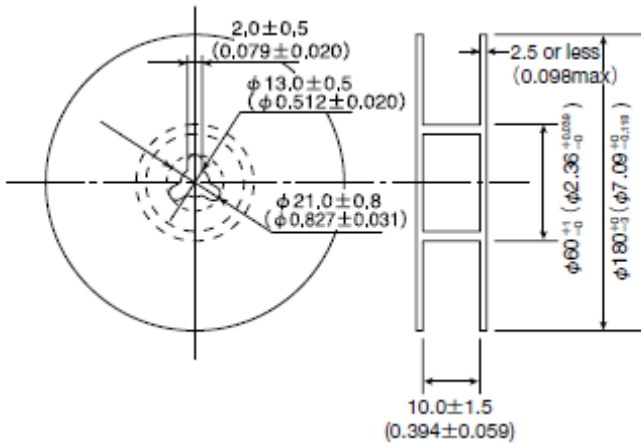

#### ⑥ Top Tape Strength

The top tape requires a peel-off force of 0.2 to 0.7N in the direction of the arrow as illustrated below.

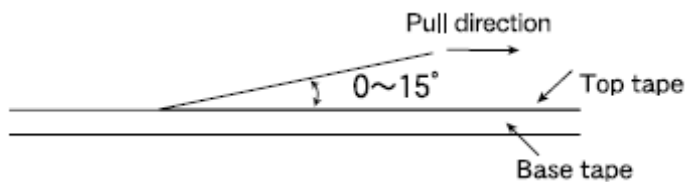

# WIRE-WOUND CHIP POWER INDUCTORS (BR SERIES)

## RELIABILITY DATA

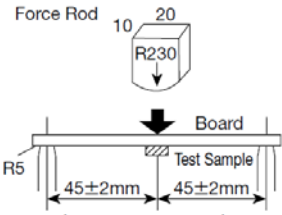
| 1. Operating Temperature Range                 |  |                                       |
|--|--|---------------------------------------|
| Specified Value                                | BR series  | -40~+105°C                            |
| Test Methods and Remarks                       | Including self-generated heat  |                                       |
| 2. Storage Temperature Range (after soldering) |  |                                       |
| Specified Value                                | BR series  | -40~+85°C                             |
| Test Methods and Remarks                       | Please refer the term of "7.Storage conditions" in Precautions.  |                                       |
| 3. Rated current                               |  |                                       |
| Specified Value                                | BR series  | Within the specified tolerance        |
| 4. Inductance                                  |  |                                       |
| Specified Value                                | BR series  | Within the specified tolerance        |
| Test Methods and Remarks                       | Measuring equipment : LCR Meter (HP 4285A or equivalent)<br>Measuring frequency : Specified frequency  |                                       |
| 5. DC Resistance                               |  |                                       |
| Specified Value                                | BR series  | Within the specified tolerance        |
| Test Methods and Remarks                       | Measuring equipment : DC ohmmeter (HIOKI 3227 or equivalent)   |                                       |
| 6. Self resonance frequency                    |  |                                       |
| Specified Value                                | BR series  | Within the specified tolerance        |
| Test Methods and Remarks                       | Measuring equipment : Impedance analyzer/material analyzer<br>(HP4291A or equivalent HP4191A, 4192A or equivalent)   |                                       |
| 7. Temperature characteristic                  |  |                                       |
| Specified Value                                | BR series  | Inductance change : Within $\pm 15\%$ |
| Test Methods and Remarks                       | Based on the inductance at 20°C and Measured at the ambient of -40°C~+85°C.  |                                       |
| 8. Resistance to the bendability               |  |                                       |
| Specified Value                                | BR series  | No damage.                            |
| Test Methods and Remarks                       | The given sample is soldered on the board and then the back side of the board is pushed until it bends 2mm like the figure.<br>Dimension of the board : 100×40×1.0mm (0.8mm thickness for 1608(0603) inductors)<br>Material of the board : Glass epoxy-resin<br>Thickness of soldering paste : 0.12mm<br> |                                       |

▶ This catalog contains the typical specification only due to the limitation of space. When you consider the purchase of our products, please check our specification. For details of each product (characteristics graph, reliability information, precautions for use, and so on), see our Web site (<http://www.ty-top.com/>).

| 9. Body strength         |  |            |
|--------------------------|--|------------|
| Specified Value          | BR series  | No damage. |
| Test Methods and Remarks | 2012~<br>Applied orce : 10N<br>Duration : 10sec.<br>1608 size<br>Applied force : 5N<br>Duration : 10sec. |            |

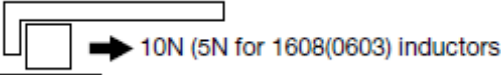
| 10. Adhesion of terminal electrodes |  |                                |
|-------------------------------------|--|--------------------------------|
| Specified Value                     | BR series  | Not to removed from the board. |
| Test Methods and Remarks            | The given sample is soldered to the board and then it is kept for 5sec with 10N stress (5N for 1608(0603) inductors) like the figure.<br> |                                |

| 11. Resistance to vibration |   |  |                     |         |  |                 |  |  |                 |                                |  |      |   |                                       |   |   |
|-----------------------------|---|--|---------------------|---------|--|-----------------|--|--|-----------------|--------------------------------|--|------|---|---------------------------------------|---|---|
| Specified Value             | BR series   | Inductance change : Within $\pm 10\%$<br>No significant abnormality in appearance. |                     |         |  |                 |  |  |                 |                                |  |      |   |                                       |   |   |
| Test Methods and Remarks    | The given sample is soldered to the board and then it is tested depending on the conditions of the following table. <table border="1" data-bbox="280 730 1155 907"> <tr> <td>Vibration Frequency</td> <td colspan="2">10~55Hz</td> </tr> <tr> <td>Total Amplitude</td> <td colspan="2">1.5mm (May not exceed acceleration 196m/s<sup>2</sup>)</td> </tr> <tr> <td>Sweeping Method</td> <td colspan="2">10Hz to 55Hz to 10Hz for 1min.</td> </tr> <tr> <td rowspan="3">Time</td> <td>X</td> <td rowspan="3">For 2 hours on each X, Y, and Z axis.</td> </tr> <tr> <td>Y</td> </tr> <tr> <td>Z</td> </tr> </table><br>Recovery : At least 2hrs of recovery under the standard condition after the test, followed by the measurement within 48hrs. |  | Vibration Frequency | 10~55Hz |  | Total Amplitude | 1.5mm (May not exceed acceleration 196m/s <sup>2</sup> ) |  | Sweeping Method | 10Hz to 55Hz to 10Hz for 1min. |  | Time | X | For 2 hours on each X, Y, and Z axis. | Y | Z |
| Vibration Frequency         | 10~55Hz   |  |                     |         |  |                 |  |  |                 |                                |  |      |   |                                       |   |   |
| Total Amplitude             | 1.5mm (May not exceed acceleration 196m/s <sup>2</sup> )  |  |                     |         |  |                 |  |  |                 |                                |  |      |   |                                       |   |   |
| Sweeping Method             | 10Hz to 55Hz to 10Hz for 1min.  |  |                     |         |  |                 |  |  |                 |                                |  |      |   |                                       |   |   |
| Time                        | X   | For 2 hours on each X, Y, and Z axis.  |                     |         |  |                 |  |  |                 |                                |  |      |   |                                       |   |   |
|                             | Y   |  |                     |         |  |                 |  |  |                 |                                |  |      |   |                                       |   |   |
|                             | Z   |  |                     |         |  |                 |  |  |                 |                                |  |      |   |                                       |   |   |

| 12. Solderability        |   |   |                    |                          |      |                  |
|--------------------------|---|---|--------------------|--------------------------|------|------------------|
| Specified Value          | BR series   | At least 90% area of the electrodes is covered by new solder. |                    |                          |      |                  |
| Test Methods and Remarks | Test Method and Remarks】<br>The given sample is dipped into the flux and then it is tested depending on the conditions of the following table.<br>Flux : Methanol solution containing rosin 25%. <table border="1" data-bbox="280 1133 699 1193"> <tr> <td>Solder Temperature</td> <td>245<math>\pm</math>5<math>^{\circ}</math>C</td> </tr> <tr> <td>Time</td> <td>5<math>\pm</math>0.5 sec.</td> </tr> </table> |   | Solder Temperature | 245 $\pm$ 5 $^{\circ}$ C | Time | 5 $\pm$ 0.5 sec. |
| Solder Temperature       | 245 $\pm$ 5 $^{\circ}$ C  |   |                    |                          |      |                  |
| Time                     | 5 $\pm$ 0.5 sec.  |   |                    |                          |      |                  |

| 13. Resistance to soldering heat |   |  |
|----------------------------------|---|--|
| Specified Value                  | BR series   | Inductance change : Within $\pm 10\%$<br>No significant abnormality in appearance. |
| Test Methods and Remarks         | 3 times reflow having the temperature profile of 5sec of 260 $\pm$ 0/ $-$ 5 $^{\circ}$ C and 40sec of more than 230 $^{\circ}$ C.<br>Test board thickness : 1.0mm<br>Test board material : Glass epoxy-resin<br>Recovery : At least 2hrs of recovery under the standard condition after the test, followed by the measurement within 48hrs. |  |

| 14. Thermal shock        |   |  |                       |  |  |      |                             |                |   |             |            |   |                  |          |   |             |            |   |                  |          |
|--------------------------|---|--|-----------------------|--|--|------|-----------------------------|----------------|---|-------------|------------|---|------------------|----------|---|-------------|------------|---|------------------|----------|
| Specified Value          | BR series   | Inductance change : Within $\pm 10\%$<br>No significant abnormality in appearance. |                       |  |  |      |                             |                |   |             |            |   |                  |          |   |             |            |   |                  |          |
| Test Methods and Remarks | The given sample is soldered to the board and then its Inductance is measured after 100cycles of the following conditions. <table border="1" data-bbox="280 1632 890 1809"> <thead> <tr> <th colspan="3">Conditions of 1 cycle</th> </tr> <tr> <th>Step</th> <th>Temperature (<math>^{\circ}</math>C)</th> <th>Duration (min)</th> </tr> </thead> <tbody> <tr> <td>1</td> <td>-40<math>\pm</math>3</td> <td>30<math>\pm</math>3</td> </tr> <tr> <td>2</td> <td>Room temperature</td> <td>Within 3</td> </tr> <tr> <td>3</td> <td>+85<math>\pm</math>2</td> <td>30<math>\pm</math>3</td> </tr> <tr> <td>4</td> <td>Room temperature</td> <td>Within 3</td> </tr> </tbody> </table><br>Recovery : At least 2hrs of recovery under the standard condition after the test, followed by the measurement within 48 hrs. |  | Conditions of 1 cycle |  |  | Step | Temperature ( $^{\circ}$ C) | Duration (min) | 1 | -40 $\pm$ 3 | 30 $\pm$ 3 | 2 | Room temperature | Within 3 | 3 | +85 $\pm$ 2 | 30 $\pm$ 3 | 4 | Room temperature | Within 3 |
| Conditions of 1 cycle    |   |  |                       |  |  |      |                             |                |   |             |            |   |                  |          |   |             |            |   |                  |          |
| Step                     | Temperature ( $^{\circ}$ C)   | Duration (min)   |                       |  |  |      |                             |                |   |             |            |   |                  |          |   |             |            |   |                  |          |
| 1                        | -40 $\pm$ 3   | 30 $\pm$ 3   |                       |  |  |      |                             |                |   |             |            |   |                  |          |   |             |            |   |                  |          |
| 2                        | Room temperature  | Within 3   |                       |  |  |      |                             |                |   |             |            |   |                  |          |   |             |            |   |                  |          |
| 3                        | +85 $\pm$ 2   | 30 $\pm$ 3   |                       |  |  |      |                             |                |   |             |            |   |                  |          |   |             |            |   |                  |          |
| 4                        | Room temperature  | Within 3   |                       |  |  |      |                             |                |   |             |            |   |                  |          |   |             |            |   |                  |          |

▶ This catalog contains the typical specification only due to the limitation of space. When you consider the purchase of our products, please check our specification. For details of each product (characteristics graph, reliability information, precautions for use, and so on), see our Web site (<http://www.ty-top.com/>).

| 15. Damp heat  |  |  |
|--|--|--|
| Specified Value  | BR series  | Inductance change : Within $\pm 10\%$<br>No significant abnormality in appearance. |
| Test Methods and Remarks   | The given sample is soldered to the board and then it is kept at the following conditions. |  |
|  | Temperature  | $60 \pm 2^\circ\text{C}$   |
|  | Humidity   | 90~95%RH   |
|  | Time   | 1000 hours.  |
| Recovery : At least 2hrs of recovery under the standard condition after the test, followed by the measurement within 48 hrs. |  |  |

| 16. Loading under damp heat  |  |  |
|--|--|--|
| Specified Value  | BR series  | Inductance change : Within $\pm 10\%$<br>No significant abnormality in appearance. |
| Test Methods and Remarks   | The given sample is soldered to the board and then it is kept at the following conditions. |  |
|  | Temperature  | $60 \pm 2^\circ\text{C}$   |
|  | Humidity   | 90~95%RH   |
|  | Applied current  | Rated current  |
|  | Time   | 1000hours.   |
| Recovery : At least 2hrs of recovery under the standard condition after the test, followed by the measurement within 48 hrs. |  |  |

| 17. Low temperature life test |  |  |
|-------------------------------|--|--|
| Specified Value               | BR series  | Inductance change : Within $\pm 10\%$<br>No significant abnormality in appearance. |
| Test Methods and Remarks      | The given sample is soldered to the board and then it is kept at the following conditions.                                   |  |
|                               | Temperature  | $-40 \pm 2^\circ\text{C}$  |
|                               | Duration   | 1000hours  |
|                               | Recovery : At least 2hrs of recovery under the standard condition after the test, followed by the measurement within 48 hrs. |  |

| 18. High temperature life test |  |  |
|--------------------------------|--|--|
| Specified Value                | BR series  | Inductance change : Within $\pm 10\%$<br>No significant abnormality in appearance. |
| Test Methods and Remarks       | The given sample is soldered to the board and then it is kept at the following conditions.                                   |  |
|                                | Temperature  | $85 \pm 2^\circ\text{C}$   |
|                                | Duration   | 1000hours  |
|                                | Recovery : At least 2hrs of recovery under the standard condition after the test, followed by the measurement within 48 hrs. |  |

| 19. Standard conditions |           |  |
|-------------------------|-----------|--|
| Specified Value         | BR series | Standard test condition :<br>Unless otherwise specified, temperature is $20 \pm 15^\circ\text{C}$ and $65 \pm 20\%$ of relative humidity.<br>When there is any question concerning measurement result: In order to provide correlation data, the test shall be condition of $20 \pm 2^\circ\text{C}$ of temperature, $65 \pm 5\%$ relative humidity.<br>Inductance is in accordance with our measured value. |

# WIRE-WOUND CHIP POWER INDUCTORS(BR SERIES)

## ■ PRECAUTIONS

| 1. Circuit Design                         |  |
|---|--|
| Precautions                               | <p>◆ Operating Ambient<br/>The products are premised on the usage for the general equipments like the office supply equipment, the telecommunications systems, the measuring equipment, the household equipment and so on.<br/>Please ask to TAIYO YUDEN's sales person in advance, if you need to apply them to the equipments or the systems which might have any influences for the human body, the property, like the traffic systems, the safety equipment, the aerospace systems, the nuclear control systems, the medical equipment and soon.</p>               |
| 2. PCB Design                             |  |
| Precautions                               | <p>◆ Land pattern design<br/>1. Please refer to a recommended land pattern.</p>  |
| Technical considerations                  | <p>◆ Land pattern design<br/>Surface Mounting<br/>1. The conditions of the picking and placing should be checked in advance.<br/>2. The products are only for reflow soldering.</p>  |
| 3. Considerations for automatic placement |  |
| Precautions                               | <p>◆ Adjustment of mounting machine<br/>1. Excessive physical impact should not be imposed on the products for picking and placing onto the PC boards.<br/>2. Mounting and soldering conditions should be checked in advance.</p>  |
| Technical considerations                  | <p>◆ Adjustment of mounting machine<br/>The products might be broken if too much stress is given for the picking and placing.</p>  |
| 4. Soldering                              |  |
| Precautions                               | <p>◆ Reflow soldering<br/>1. Please apply our recommended soldering conditions on the specification as much as possible.<br/>2. The products are only for reflow soldering.<br/>3. Please do not give any stress to a product until it returns in room temperature after reflow soldering.</p> <p>◆ Recommended conditions for using a soldering iron. (Excluding 1608 type)<br/>Touch a soldering iron to the land pattern not to the product directly.<br/>The temperature of a soldering iron is less than 350degC.<br/>The soldering is for 3 seconds or less.</p> |
| Technical considerations                  | <p>◆ Reflow soldering<br/>1. The product might break or might make the tombstoning, if the soldering conditions are too far from our recommended conditions.</p> <p>Temperature [°C]</p> <p>Heating Time [sec]</p> <p>150~180</p> <p>90±30sec</p> <p>30±10sec</p> <p>230°C min</p> <p>5sec max</p> <p>Peak: 260±0/-5°C</p>   |
| 5. Cleaning                               |  |
| Precautions                               | <p>◆ Cleaning conditions<br/>1. Please don't wash by the ultra-sonic waves.</p>  |
| Technical considerations                  | <p>◆ Cleaning conditions<br/>1. Washing by the ultra-sonic waves might break the product.</p>  |

| 6. Handling              |  |
|--------------------------|--|
| Precautions              | <ul style="list-style-type: none"> <li>◆ Handling               <ol style="list-style-type: none"> <li>1. Keep the product away from any magnets.</li> </ol> </li> <li>◆ Cutting the PC boards               <ol style="list-style-type: none"> <li>1. Please don't give any stress of the bending or the twisting for the cutting process of PC boards.</li> <li>2. Please don't give any shock and stress to the products in transportation.</li> </ol> </li> <li>◆ Mechanical considerations               <ol style="list-style-type: none"> <li>1. Please don't give too much shock to the product.</li> <li>2. Please don't give any shock and stress to the products in transportation.</li> </ol> </li> <li>◆ The stress for picking and placing               <ol style="list-style-type: none"> <li>1. Please don't give any shock into an exposed ferrite core.</li> </ol> </li> <li>◆ Packing               <ol style="list-style-type: none"> <li>1. Please don't pile the packing boxes up as much as possible.</li> </ol> </li> </ul> |
| Technical considerations | <ul style="list-style-type: none"> <li>◆ Handling               <ol style="list-style-type: none"> <li>1. There is a case that a characteristic varies with magnetic influence.</li> </ol> </li> <li>◆ Cutting the PC boards               <ol style="list-style-type: none"> <li>1. Please don't give the bending stress or the twisting stress to the products because they might break in such cases.</li> </ol> </li> <li>◆ Mechanical considerations               <ol style="list-style-type: none"> <li>1. The mechanical shock might break the products.</li> <li>2. The products might break depending on the handling in transportation.</li> </ol> </li> <li>◆ Pick-up pressure               <ol style="list-style-type: none"> <li>1. The electrical characteristics of the products might be shifted by too much physical shock and stress.</li> </ol> </li> <li>◆ Packing               <ol style="list-style-type: none"> <li>1. The products and the tape might break, if the packing boxes are piled up.</li> </ol> </li> </ul>    |
| 7. Storage conditions    |  |
| Precautions              | <ul style="list-style-type: none"> <li>◆ Storage               <ol style="list-style-type: none"> <li>1. To maintain the solderability of terminal electrodes and to keep the packing material in good condition, temperature and humidity in the storage area should be controlled.                   <ul style="list-style-type: none"> <li>▪ Recommended conditions                       <ul style="list-style-type: none"> <li>Ambient temperature : 0~40°C</li> <li>Humidity : Below 70% RH</li> </ul> </li> <li>▪ The ambient temperature must be kept below 30°C. Even under ideal storage conditions, solderability of products electrodes may decrease as time passes.                           <ul style="list-style-type: none"> <li>For this reason, product should be used within 6 months from the time of delivery.</li> <li>In case of storage over 6 months, solderability shall be checked before actual usage.</li> </ul> </li> </ul> </li> </ol> </li> </ul>   |
| Technical considerations | <ul style="list-style-type: none"> <li>◆ Storage               <ol style="list-style-type: none"> <li>1. The ambient of high temperature or high humidity might accelerate to make the solderability and the tape worse.</li> </ol> </li> </ul>  |





## Looking for pricing, stock, or lifecycle information?

Click below to explore more details on WIN SOURCE:

 [View BRL2012T330M on WIN SOURCE](#)

 [Taiyo Yuden Information](#)

## Optimize Your Supply Chain with WIN SOURCE Solutions

-  Global Sourcing Solution
-  Obsolete Management
-  Cost Control Management
-  Shortage Management
-  Alternative Solution
-  Excess Inventory Management