



**THE DATASHEET OF  
AD9245BCPZRL7-20**



## FEATURES

Single 3 V supply operation (2.7 V to 3.6 V)

SNR = 72.7 dBc to Nyquist

SFDR = 83.0 dBc to Nyquist

Low power

366 mW at 80 MSPS

300 mW at 65 MSPS

165 mW at 40 MSPS

90 mW at 20 MSPS

Differential input with 500 MHz bandwidth

On-chip reference and sample-and-hold

DNL =  $\pm 0.5$  LSB

Flexible analog input: 1 V p-p to 2 V p-p range

Offset binary or twos complement data format

Clock duty-cycle stabilizer

## APPLICATIONS

Medical imaging equipment

IF sampling in communications receivers

WCDMA, CDMA-One, CDMA-2000, and TDS-CDMA

Battery-powered instruments

Hand-held scopemeters

Spectrum analyzers

Power-sensitive military applications

## GENERAL DESCRIPTION

The AD9245 is a monolithic, single 3 V supply, 14-bit, 20 MSPS/40 MSPS/65 MSPS/80 MSPS analog-to-digital converter (ADC) featuring a high performance sample-and-hold amplifier (SHA) and voltage reference. The AD9245 uses a multistage differential pipelined architecture with output error correction logic to provide 14-bit accuracy and guarantee no missing codes over the full operating temperature range.

The wide bandwidth, truly differential SHA allows a variety of user-selectable input ranges and common modes, including single-ended applications. It is suitable for multiplexed systems that switch full-scale voltage levels in successive channels and for sampling single-channel inputs at frequencies well beyond the Nyquist rate. Combined with power and cost savings over previously available analog-to-digital converters, the AD9245 is suitable for applications in communications, imaging, and medical ultrasound.

## FUNCTIONAL BLOCK DIAGRAM

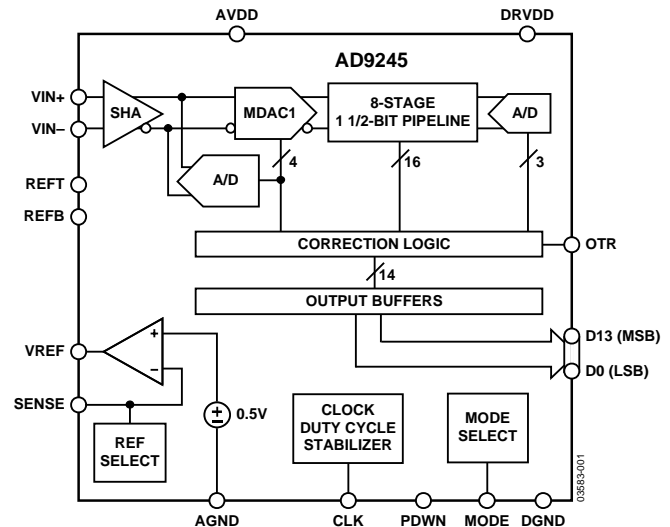

Figure 1.

A single-ended clock input is used to control all internal conversion cycles. A duty cycle stabilizer (DCS) compensates for wide variations in the clock duty cycle while maintaining excellent overall ADC performance. The digital output data is presented in straight binary or twos complement formats. An out-of-range (OTR) signal indicates an overflow condition that can be used with the most significant bit to determine low or high overflow. Fabricated on an advanced CMOS process, the AD9245 is available in a 32-lead LFCSP and is specified over the industrial temperature range ( $-40^{\circ}\text{C}$  to  $+85^{\circ}\text{C}$ ).

## PRODUCT HIGHLIGHTS

1. The AD9245 operates from a single 3 V power supply and features a separate digital output driver supply to accommodate 2.5 V and 3.3 V logic families.
2. The patented SHA input maintains excellent performance for input frequencies up to 100 MHz and can be configured for single-ended or differential operation.
3. The AD9245 is pin-compatible with the AD9215, AD9235, and AD9236. This allows a simplified migration from 10 bits to 14 bits and 20 MSPS to 80 MSPS.
4. The clock DCS maintains overall ADC performance over a wide range of clock pulse widths.
5. The OTR output bit indicates when the signal is beyond the selected input range.

Rev. E

[Document Feedback](#)

Information furnished by Analog Devices is believed to be accurate and reliable. However, no responsibility is assumed by Analog Devices for its use, nor for any infringements of patents or other rights of third parties that may result from its use. Specifications subject to change without notice. No license is granted by implication or otherwise under any patent or patent rights of Analog Devices. Trademarks and registered trademarks are the property of their respective owners.

## TABLE OF CONTENTS

Features .....	1	Typical Performance Characteristics .....	13
Applications .....	1	Theory of Operation .....	18
General Description .....	1	Analog Input and Reference Overview .....	18
Functional Block Diagram .....	1	Clock Input Considerations .....	19
Product Highlights .....	1	Jitter Considerations .....	20
Revision History .....	2	Power Dissipation and Standby Mode .....	20
Specifications .....	3	Digital Outputs .....	20
DC Specifications .....	3	Timing .....	21
AC Specifications .....	5	Voltage Reference .....	21
Digital Specifications .....	7	Internal Reference Connection .....	21
Switching Specifications .....	8	External Reference Operation .....	22
Absolute Maximum Ratings .....	9	Operational Mode Selection .....	22
Thermal Resistance .....	9	Evaluation Board .....	22
ESD Caution .....	9	Outline Dimensions .....	29
Terminology .....	10	Ordering Guide .....	29
Pin Configuration and Function Descriptions .....	11		
Equivalent Circuits .....	12		
<b>REVISION HISTORY</b>			
<b>5/13—Rev. D to Rev. E</b>			
Changed CP-32-2 to CP-32-7 .....	Universal	Changes to Table 5 .....	7
Changes to Figure 3 and Table 9 .....	11	Changes to Table 6 .....	8
Changes to Figure 40 .....	19	Deleted Explanation of Test Levels Table .....	8
Changes to Ordering Guide .....	29	Added Figure 26 to Figure 31; Renumbered Sequentially .....	16
		Added Figure 32 to Figure 37; Renumbered Sequentially .....	17
		Changes to Figure 39 .....	18
		Changes to Clock Input Consideration Section .....	19
		Changes to Figure 44 .....	20
		Changes to Table 10 .....	21
		Changes to Figure 51 .....	25
		Changes to Table 12 .....	28
		Changes to Ordering Guide .....	29
		Updated Outline Dimensions .....	29
		<b>10/03—Rev. A to Rev. B</b>	
		Changes to Figure 33 .....	17
		<b>5/03—Rev. 0 to Rev. A</b>	
		Changes to Figure 30 .....	15
		Changes to Figure 37 .....	19
		Changes to Figure 38 .....	20
		Changes to Figure 39 .....	21
		Changes to Table 10 .....	24
		Changes to the Ordering Guide .....	25
<b>8/05—Rev. B to Rev. C</b>			
Updated Format .....	Universal		
Changes to Features, Applications, General Description, and Product Highlights .....	1		
Added Table 1; Renumbered Sequentially .....	3		
Changes to Table 2 .....	4		
Added Table 3; Renumbered Sequentially .....	5		
Changes to Table 4 .....	6		

## SPECIFICATIONS

### DC SPECIFICATIONS

AVDD = 3 V, DRVDD = 2.5 V, maximum sample rate, 2 V p-p differential input, 1.0 V internal reference, unless otherwise noted.

Table 1.

Parameter	AD9245BCP-20			AD9245BCP-40			AD9245BCP-65			Unit
	Min	Typ	Max	Min	Typ	Max	Min	Typ	Max	
RESOLUTION	14			14			14			Bits
ACCURACY	14			14			14			Bits
No Missing Codes Guaranteed	14			14			14			Bits
Offset Error		±0.30	±1.60		±0.50	±1.75		±0.50	±1.75	% FSR
Gain Error <sup>1</sup>		±0.30	±3.25		±0.50	±3.25		±0.50	±6.90	% FSR
Differential Nonlinearity (DNL) <sup>2</sup>		±0.50	±1.00		±0.50	±1.00		±0.50	±1.00	LSB
Integral Nonlinearity (INL) <sup>2</sup>		±1.20	±3.10		±1.40	±3.40		±1.60	±5.55	LSB
TEMPERATURE DRIFT <sup>1</sup>										
Offset Error		±2			±2			±3		ppm/°C
Gain Error		±12			±12			±12		ppm/°C
INTERNAL VOLTAGE REFERENCE										
Output Voltage Error (1 V Mode)		±5	±35		±5	±35		±5	±35	mV
Load Regulation @ 1.0 mA		0.8			0.8			0.8		mV
Output Voltage Error (0.5 V Mode)		±2.5			±2.5			±2.5		mV
Load Regulation @ 0.5 mA		0.1			0.1			0.1		mV
INPUT REFERRED NOISE										
VREF = 0.5 V		2.28			2.28			2.28		LSB rms
VREF = 1.0 V		1.08			1.08			1.08		LSB rms
ANALOG INPUT										
Input Span, VREF = 0.5 V		1			1			1		V p-p
Input Span, VREF = 1.0 V		2			2			2		V p-p
Input Capacitance <sup>3</sup>		7			7			7		pF
REFERENCE INPUT RESISTANCE		7			7			7		kΩ
POWER SUPPLIES										
Supply Voltages										
AVDD	2.7	3.0	3.6	2.7	3.0	3.6	2.7	3.0	3.6	V
DRVDD	2.25	3.0	3.6	2.25	3.0	3.6	2.25	3.0	3.6	V
Supply Current										
IAVDD <sup>2</sup>		30			55			100		mA
IDRVDD <sup>2</sup>		2			5			7		mA
PSRR		±0.01			±0.01			±0.01		% FSR
POWER CONSUMPTION										
DC Input <sup>4</sup>		90			165			300		mW
Sine Wave Input <sup>2</sup>		95	120		180	220		320	375	mW
Standby Power <sup>5</sup>		1.0			1.0			1.0		mW

<sup>1</sup> Gain errors and gain temperature coefficients are based on the ADC only (with a fixed 1.0 V external reference).

<sup>2</sup> Measured at maximum clock rate, low input frequency, full-scale sine wave, with approximately 5 pF loading on each output bit.

<sup>3</sup> Input capacitance refers to the effective capacitance between one differential input pin and AGND.

<sup>4</sup> Measured with dc input at maximum clock rate.

<sup>5</sup> Standby power is measured with a dc input, the CLK pin inactive (that is, set to AVDD or AGND).

AVDD = 3 V, DRVDD = 2.5 V, sample rate = 80 MSPS, 2 V p-p differential input, 1.0 V external reference, unless otherwise noted.

Table 2.

Parameter	AD9245BCP-80			Unit
	Min	Typ	Max	
RESOLUTION	14			Bits
ACCURACY		Guaranteed		
No Missing Codes				
Offset Error <sup>1</sup>		±0.30	±1.2	% FSR
Gain Error		±0.28		% FSR
Gain Error <sup>1</sup>		±0.70	±4.16	% FSR
Differential Nonlinearity (DNL) <sup>2</sup>		±0.5	±1.0	LSB
Integral Nonlinearity (INL) <sup>2</sup>		±1.4	±5.15	LSB
TEMPERATURE DRIFT				
Offset Error <sup>1</sup>		±10		ppm/°C
Gain Error		±12		ppm/°C
Gain Error <sup>1</sup>		±17		ppm/°C
INTERNAL VOLTAGE REFERENCE				
Output Voltage Error (1 V Mode)		±3	±34	mV
Load Regulation @ 1.0 mA		±2		mV
Output Voltage Error (0.5 V Mode)		±6		mV
Load Regulation @ 0.5 mA		±1		mV
INPUT REFERRED NOISE				
VREF = 0.5 V		1.86		LSB rms
VREF = 1.0 V		1.17		LSB rms
ANALOG INPUT				
Input Span, VREF = 0.5 V		1		V p-p
Input Span, VREF = 1.0 V		2		V p-p
Input Capacitance <sup>3</sup>		7		pF
REFERENCE INPUT RESISTANCE		7		kΩ
POWER SUPPLIES				
Supply Voltage				
AVDD	2.7	3.0	3.6	V
DRVDD	2.25	2.5	3.6	V
Supply Current				
IAVDD <sup>2</sup>		122	138	mA
IDRVDD <sup>2</sup>		9		mA
PSRR		±0.01		% FSR
POWER CONSUMPTION				
Low Frequency Input <sup>4</sup>		366		mW
Standby Power <sup>5</sup>		1.0		mW

<sup>1</sup> With a 1.0 V internal reference.

<sup>2</sup> Measured at the maximum clock rate, low input frequency, full-scale sine wave, with approximately 5 pF loading on each output bit.

<sup>3</sup> Input capacitance refers to the effective capacitance between one differential input pin and AGND. See Figure 4 for the equivalent analog input structure.

<sup>4</sup> Measured at ac specification conditions without output drivers.

<sup>5</sup> Standby power is measured with a dc input, CLK pin inactive (that is, set to AVDD or AGND).

**AC SPECIFICATIONS**

AVDD = 3 V, DRVDD = 2.5 V, maximum sample rate, 2 V p-p differential input, 1.0 V internal reference, AIN = -0.5 dBFS, DCS off, unless otherwise noted.

**Table 3.**

Parameter	AD9245BCP-20			AD9245BCP-40			AD9245BCP-65			Unit
	Min	Typ	Max	Min	Typ	Max	Min	Typ	Max	
SIGNAL-TO-NOISE RATIO (SNR)										
$f_{\text{INPUT}} = 2.4 \text{ MHz}$		73.5			73.5			73.1		dBc
$f_{\text{INPUT}} = 9.7 \text{ MHz}$	70.6	73.3								dBc
$f_{\text{INPUT}} = 19.6 \text{ MHz}$				70.5	73.4					dBc
$f_{\text{INPUT}} = 32.5 \text{ MHz}$							70.3	72.7		dBc
$f_{\text{INPUT}} = 100 \text{ MHz}$		70.8			71.3			70.2		dBc
SIGNAL-TO-NOISE RATIO AND DISTORTION (SINAD)										
$f_{\text{INPUT}} = 2.4 \text{ MHz}$		73.4			73.4			73.0		dBc
$f_{\text{INPUT}} = 9.7 \text{ MHz}$	69.4	73.2								dBc
$f_{\text{INPUT}} = 19.6 \text{ MHz}$				70.0	73.2					dBc
$f_{\text{INPUT}} = 32.5 \text{ MHz}$							68.4	72.6		dBc
$f_{\text{INPUT}} = 100 \text{ MHz}$		69.5			69.1			67.9		dBc
EFFECTIVE NUMBER OF BITS (ENOB)										
$f_{\text{INPUT}} = 9.7 \text{ MHz}$		11.9								Bits
$f_{\text{INPUT}} = 19.6 \text{ MHz}$					11.8					Bits
$f_{\text{INPUT}} = 32.5 \text{ MHz}$								11.7		Bits
WORST HARMONIC (SECOND OR THIRD)										
$f_{\text{INPUT}} = 9.7 \text{ MHz}$		-89	-80							dBc
$f_{\text{INPUT}} = 19.6 \text{ MHz}$				-89	-80					dBc
$f_{\text{INPUT}} = 32.5 \text{ MHz}$							-83	-74		dBc
SPURIOUS-FREE DYNAMIC RANGE (SFDR)										
$f_{\text{INPUT}} = 2.4 \text{ MHz}$		92.0			92.0			92.0		dBc
$f_{\text{INPUT}} = 9.7 \text{ MHz}$	80.0	89.0								dBc
$f_{\text{INPUT}} = 19.6 \text{ MHz}$				80.0	89.0					dBc
$f_{\text{INPUT}} = 32.5 \text{ MHz}$							74.0	83.0		dBc
$f_{\text{INPUT}} = 100 \text{ MHz}$		84.0			85.0			80.5		dBc

AVDD = 3 V, DRVDD = 2.5 V, sample rate = 80 MSPS, 2 V p-p differential input, 1.0 V external reference, AIN = -0.5 dBFS, DCS off, unless otherwise noted.

Table 4.

Parameter	AD9245BCP-80			Unit
	Min	Typ	Max	
SIGNAL-TO-NOISE RATIO (SNR)				
$f_{IN} = 2.4$ MHz	71.1	73.3		dB
$f_{IN} = 40$ MHz		72.7		dB
$f_{IN} = 70$ MHz	70.5	71.7		dB
$f_{IN} = 100$ MHz		70.2		dB
SIGNAL-TO-NOISE AND DISTORTION (SINAD)				
$f_{IN} = 2.4$ MHz	70.7	73.2		dB
$f_{IN} = 40$ MHz		72.5		dB
$f_{IN} = 70$ MHz	69.9	71.2		dB
$f_{IN} = 100$ MHz		69.6		dB
EFFECTIVE NUMBER OF BITS (ENOB)				
$f_{IN} = 2.4$ MHz	11.5	11.9		Bits
$f_{IN} = 40$ MHz		11.8		Bits
$f_{IN} = 70$ MHz	11.3	11.5		Bits
$f_{IN} = 100$ MHz		11.3		Bits
WORST HARMONIC (SECOND OR THIRD)				
$f_{IN} = 2.4$ MHz		-92.8	-76.5	dBc
$f_{IN} = 40$ MHz		-87.6		dBc
$f_{IN} = 70$ MHz		-81.6	-75.7	dBc
$f_{IN} = 100$ MHz		-79.0		dBc
SPURIOUS-FREE DYNAMIC RANGE (SFDR)				
$f_{IN} = 2.4$ MHz	76.5	92.8		dBc
$f_{IN} = 40$ MHz		87.6		dBc
$f_{IN} = 70$ MHz	75.7	81.6		dBc
$f_{IN} = 100$ MHz		79.0		dBc

**DIGITAL SPECIFICATIONS**

AVDD = 3 V, DRVDD = 2.5 V, 1.0 V internal reference, unless otherwise noted.

Table 5.

Parameter	AD9245BCP-20/AD9245BCP-40/AD9245BCP-65/AD9245BCP-80 <sup>1</sup>			Unit
	Min	Typ	Max	
LOGIC INPUTS (CLK, PDWN)				
High Level Input Voltage	2.0			V
Low Level Input Voltage			0.8	V
High Level Input Current	-10		+10	μA
Low Level Input Current	-10		+10	μA
Input Capacitance		2		pF
DIGITAL OUTPUT BITS (D0 to D13, OTR) <sup>2</sup>				
DRVDD = 3.3 V				
High Level Output Voltage (IOH = 50 μA)	3.29			V
High Level Output Voltage (IOH = 0.5 mA)	3.25			V
Low Level Output Voltage (IOH = 1.6 mA)			0.2	V
Low Level Output Voltage (IOH = 50 μA)			0.05	V
DRVDD = 2.5 V				
High Level Output Voltage (IOH = 50 μA)	2.49			V
High Level Output Voltage (IOH = 0.5 mA)	2.45			V
Low Level Output Voltage (IOH = 1.6 mA)			0.2	V
Low Level Output Voltage (IOH = 50 μA)			0.05	V

<sup>1</sup> AD9245BCP-80 performance measured with 1.0 V external reference.

<sup>2</sup> Output voltage levels measured with 5 pF load on each output.

**SWITCHING SPECIFICATIONS**

AVDD = 3 V, DRVDD = 2.5 V, unless otherwise noted.

Table 6.

Parameter	AD9245BCP-20			AD9245BCP-40			AD9245BCP-65			AD9245BCP-80			Unit
	Min	Typ	Max	Min	Typ	Max	Min	Typ	Max	Min	Typ	Max	
CLOCK INPUT PARAMETERS													
Maximum Conversion Rate	20			40			65			80			MSPS
Minimum Conversion Rate			1			1			1			1	MSPS
CLK Period	50.0			25.0			15.4			12.5			ns
CLK Pulse Width High <sup>1</sup>	15.0			8.8			6.2			4.6			ns
CLK Pulse Width Low <sup>1</sup>	15.0			8.8			6.2			4.6			ns
DATA OUTPUT PARAMETERS													
Output Delay <sup>2</sup> (t <sub>PD</sub> )		3.5			3.5			3.5			4.2		ns
Pipeline Delay (Latency)		7			7			7			7		Cycles
Aperture Delay (t <sub>A</sub> )		1.0			1.0			1.0			1.0		ns
Aperture Uncertainty Jitter (t <sub>j</sub> )		0.5			0.5			0.5			0.3		ps rms
Wake-Up Time <sup>3</sup>		3.0			3.0			3.0			7.0		ms
OUT-OF-RANGE RECOVERY TIME		1			1			2			2		Cycles

<sup>1</sup> For the AD9245BCP-65 and AD9245BCP-80 models only, with duty cycle stabilizer enabled. DCS function not applicable for AD9245BCP-20 and AD9245BCP-40 models.

<sup>2</sup> Output delay is measured from CLK 50% transition to DATA 50% transition, with 5 pF load on each output.

<sup>3</sup> Wake-up time is dependent on value of decoupling capacitors; typical values shown with 0.1 μF and 10 μF capacitors on REFT and REFB.

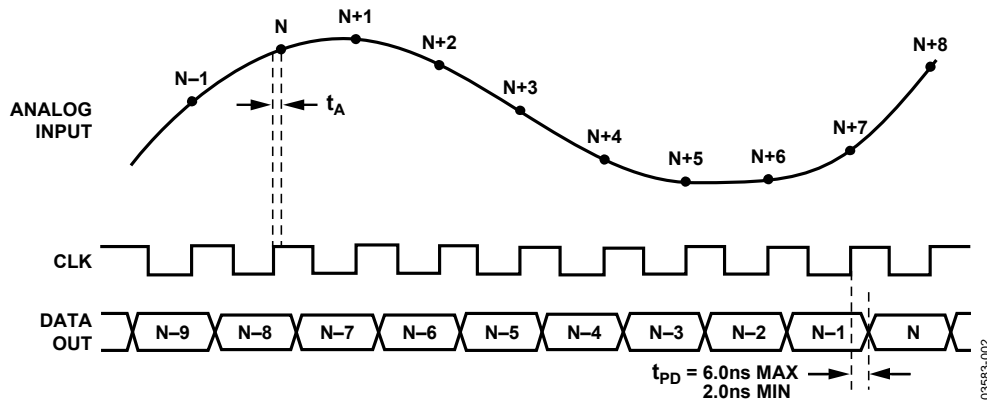

Figure 2. Timing Diagram

## ABSOLUTE MAXIMUM RATINGS

Table 7.

Parameter	With Respect to	Min	Max	Unit
<b>ELECTRICAL</b>				
AVDD	AGND	-0.3	+3.9	V
DRVDD	DGND	-0.3	+3.9	V
AGND	DGND	-0.3	+0.3	V
AVDD	DRVDD	-3.9	+3.9	V
D0 to D13	DGND	-0.3	DRVDD + 0.3	V
CLK, MODE	AGND	-0.3	AVDD + 0.3	V
VIN+, VIN-	AGND	-0.3	AVDD + 0.3	V
VREF	AGND	-0.3	AVDD + 0.3	V
SENSE	AGND	-0.3	AVDD + 0.3	V
REFT, REFB	AGND	-0.3	AVDD + 0.3	V
PDWN	AGND	-0.3	AVDD + 0.3	V
<b>ENVIRONMENTAL</b>				
Storage Temperature Range		-65	+125	°C
Operating Temperature Range		-40	+85	°C
Lead Temperature (Soldering 10 sec)			300	°C
Junction Temperature			150	°C

Stresses above those listed under Absolute Maximum Ratings may cause permanent damage to the device. This is a stress rating only; functional operation of the device at these or any other conditions above those indicated in the operational section of this specification is not implied. Exposure to absolute maximum rating conditions for extended periods may affect device reliability.

### ESD CAUTION

ESD (electrostatic discharge) sensitive device. Electrostatic charges as high as 4000V readily accumulate on the human body and test equipment and can discharge without detection. Although this product features proprietary ESD protection circuitry, permanent damage may occur on devices subjected to high energy electrostatic discharges. Therefore, proper ESD precautions are recommended to avoid performance degradation or loss of functionality.



### THERMAL RESISTANCE

$\theta_{JA}$  is specified for the worst-case conditions on a 4-layer board in still air, in accordance with EIA/JESD51-1.

Table 8. Thermal Resistance

Package Type	$\theta_{JA}$	$\theta_{JC}$	Unit
32-Lead LFCSP	32.5	32.71	°C/W

Airflow increases heat dissipation, effectively reducing  $\theta_{JA}$ . In addition, more metal directly in contact with the package leads from metal traces, through holes, ground, and power planes reduces the  $\theta_{JA}$ . It is recommended that the exposed paddle be soldered to the ground plane for the LFCSP package. There is an increased reliability of the solder joints, and maximum thermal capability of the package is achieved with the exposed paddle soldered to the customer board.

## TERMINOLOGY

### Analog Bandwidth (Full Power Bandwidth)

The analog input frequency at which the spectral power of the fundamental frequency (as determined by the FFT analysis) is reduced by 3 dB.

### Aperture Delay ( $t_A$ )

The delay between the 50% point of the rising edge of the clock and the instant at which the analog input is sampled.

### Aperture Uncertainty (Jitter, $t_j$ )

The sample-to-sample variation in aperture delay.

### Integral Nonlinearity (INL)

The deviation of each individual code from a line drawn from negative full scale through positive full scale. The point used as negative full scale occurs  $\frac{1}{2}$  LSB before the first code transition. Positive full scale is defined as a level  $1\frac{1}{2}$  LSB beyond the last code transition. The deviation is measured from the middle of each particular code to the true straight line.

### Differential Nonlinearity (DNL, No Missing Codes)

An ideal ADC exhibits code transitions that are exactly 1 LSB apart. DNL is the deviation from this ideal value. Guaranteed no missing codes to 14-bit resolution indicates that all 16,384 codes must be present over all operating ranges.

### Offset Error

The major carry transition should occur for an analog value  $\frac{1}{2}$  LSB below  $V_{IN+} = V_{IN-}$ . Offset error is defined as the deviation of the actual transition from that point.

### Gain Error

The first code transition should occur at an analog value  $\frac{1}{2}$  LSB above negative full scale. The last transition should occur at an analog value  $1\frac{1}{2}$  LSB below the positive full scale. Gain error is the deviation of the actual difference between first and last code transitions and the ideal difference between first and last code transitions.

### Temperature Drift

The temperature drift for offset error and gain error specifies the maximum change from the initial (25°C) value to the value at  $T_{MIN}$  or  $T_{MAX}$ .

### Power Supply Rejection Ratio

The change in full scale from the value with the supply at the minimum limit to the value with the supply at its maximum limit.

### Total Harmonic Distortion (THD)<sup>1</sup>

The ratio of the rms input signal amplitude to the rms value of the sum of the first six harmonic components.

### Signal-to-Noise and Distortion (SINAD)<sup>1</sup>

The ratio of the rms input signal amplitude to the rms value of the sum of all other spectral components below the Nyquist frequency, including harmonics but excluding dc.

### Effective Number of Bits (ENOB)

The effective number of bits for a sine wave input at a given input frequency can be calculated directly from its measured SINAD using the following formula:

$$ENOB = \frac{(SINAD - 1.76)}{6.02}$$

### Signal-to-Noise Ratio (SNR)<sup>1</sup>

The ratio of the rms input signal amplitude to the rms value of the sum of all other spectral components below the Nyquist frequency, excluding the first six harmonics and dc.

### Spurious-Free Dynamic Range (SFDR)<sup>1</sup>

The difference in dB between the rms input signal amplitude and the peak spurious signal. The peak spurious component may or may not be a harmonic.

### Two-Tone SFDR<sup>1</sup>

The ratio of the rms value of either input tone to the rms value of the peak spurious component. The peak spurious component may or may not be an IMD product.

### Clock Pulse Width and Duty Cycle

Pulse width high is the minimum amount of time that the clock pulse should be left in the Logic 1 state to achieve rated performance. Pulse width low is the minimum time the clock pulse should be left in the Logic 0 state. At a given clock rate, these specifications define an acceptable clock duty cycle.

### Minimum Conversion Rate

The clock rate at which the SNR of the lowest analog signal frequency drops by no more than 3 dB below the guaranteed limit.

### Maximum Conversion Rate

The clock rate at which parametric testing is performed.

### Output Propagation Delay ( $t_{PD}$ )

The delay between the clock rising edge and the time when all bits are within valid logic levels.

### Out-of-Range Recovery Time

The time it takes for the ADC to reacquire the analog input after a transition from 10% above positive full scale to 10% above negative full scale, or from 10% below negative full scale to 10% below positive full scale.

<sup>1</sup> AC specifications may be reported in dBc (degrades as signal levels are lowered) or in dBFS (always related back to converter full scale).

# PIN CONFIGURATION AND FUNCTION DESCRIPTIONS

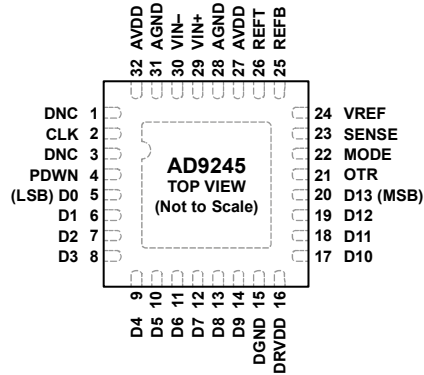

- NOTES**
1. DNC = DO NOT CONNECT. DO NOT CONNECT TO THIS PIN.
  2. IT IS RECOMMENDED THAT THE EXPOSED PADDLE BE SOLDERED TO THE GROUND PLANE FOR THE LFCSP PACKAGE. THERE IS AN INCREASED RELIABILITY OF THE SOLDER JOINTS, AND THE MAXIMUM THERMAL CAPABILITY OF THE PACKAGE IS ACHIEVED WITH THE EXPOSED PADDLE SOLDERED TO THE CUSTOMER BOARD.

Figure 3. LFCSP Pin Configuration

Table 9. Pin Function Descriptions

Pin No.	Mnemonic	Description
1, 3	DNC	Do Not Connect
2	CLK	Clock Input Pin
4	PDWN	Power-Down Function Select
5 to 14, 17 to 20	D0 (LSB) to D13 (MSB)	Data Output Bits
15	DGND	Digital Output Ground
16	DRVDD	Digital Output Driver Supply
21	OTR	Out-of-Range Indicator
22	MODE	Data Format Select and DCS Mode Selection (See Table 11)
23	SENSE	Reference Mode Selection (See Table 10)
24	VREF	Voltage Reference Input/Output
25	REFB	Differential Reference (-)
26	REFT	Differential Reference (+)
27, 32	AVDD	Analog Power Supply
28, 31	AGND	Analog Ground
29	VIN+	Analog Input Pin (+)
30	VIN-	Analog Input Pin (-)
EPAD		Exposed Pad. It is recommended that the exposed paddle be soldered to the ground plane for the LFCSP package. There is an increased reliability of the solder joints, and the maximum thermal capability of the package is achieved with the exposed paddle soldered to the customer board.

EQUIVALENT CIRCUITS

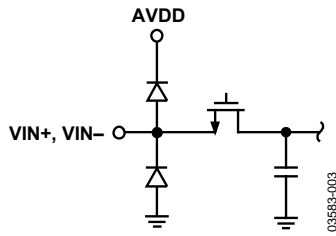

Figure 4. Equivalent Analog Input Circuit

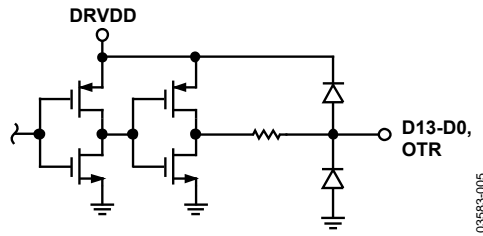

Figure 6. Equivalent Digital Output Circuit

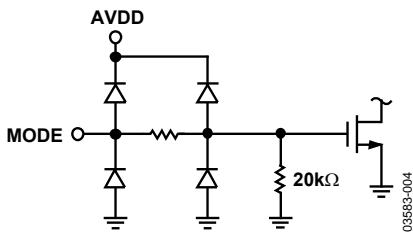

Figure 5. Equivalent MODE Input Circuit

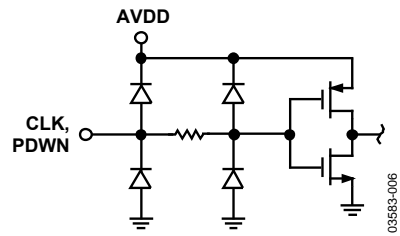

Figure 7. Equivalent Digital Input Circuit

# TYPICAL PERFORMANCE CHARACTERISTICS

DUT = AD9245-80, AVDD = 3.0 V, DRVDD = 2.5 V, maximum sample rate, DCS disabled, T<sub>A</sub> = 25°C, 2 V p-p differential input, AIN = -0.5 dBFS, VREF = 1.0 V external, unless otherwise noted.

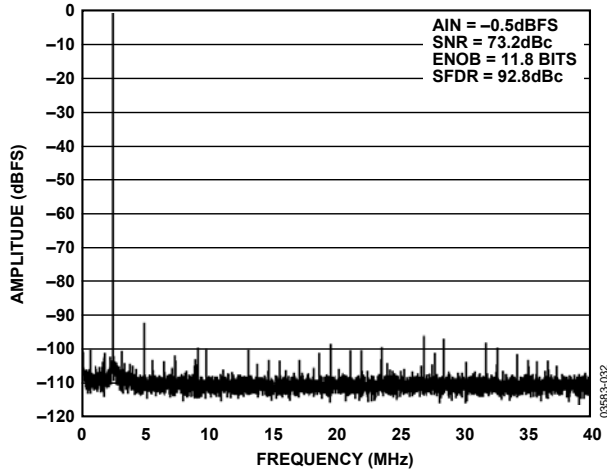

Figure 8. Single Tone 8K FFT @ 2.5 MHz

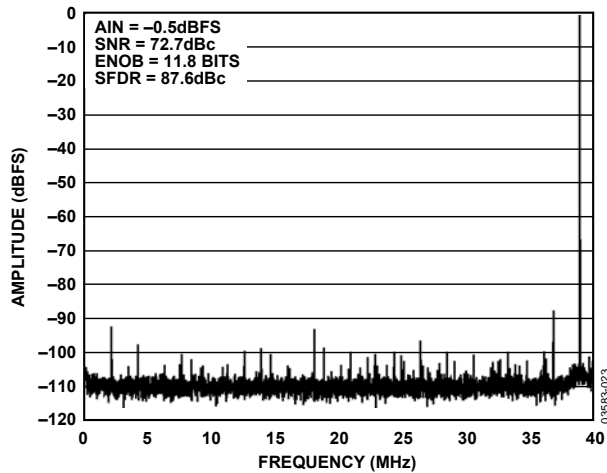

Figure 9. Single Tone 8K FFT @ 39 MHz

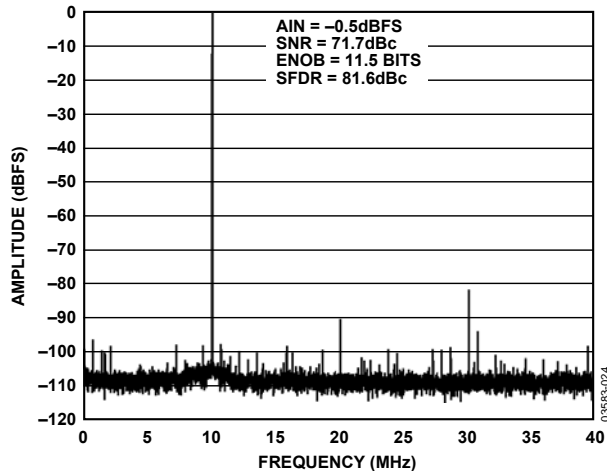

Figure 10. Single Tone 8K FFT @ 70 MHz

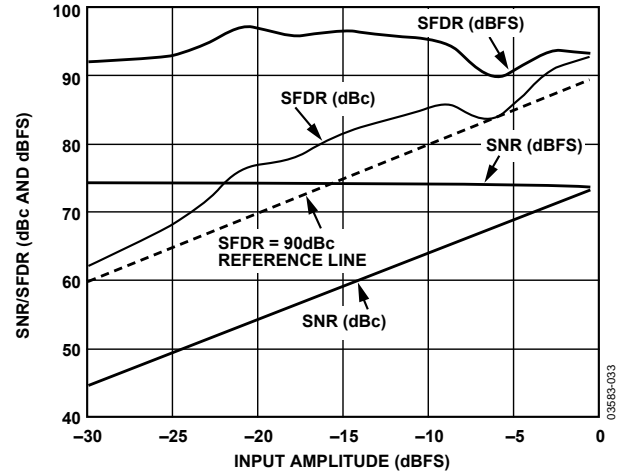

Figure 11. Single Tone SNR/SFDR vs. Input Amplitude (AIN) @ 2.5 MHz

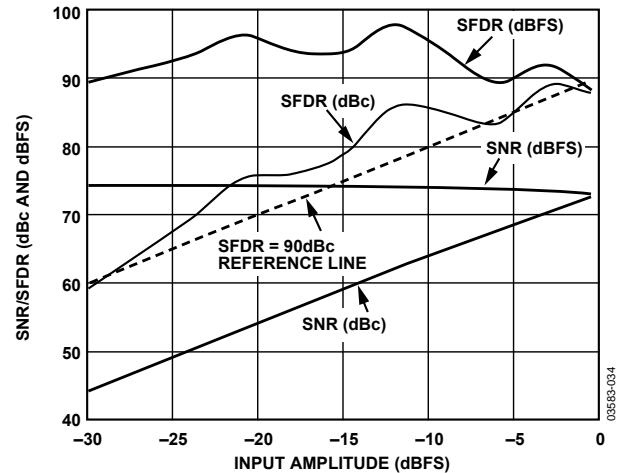

Figure 12. Single Tone SNR/SFDR vs. Input Amplitude (AIN) @ 39 MHz

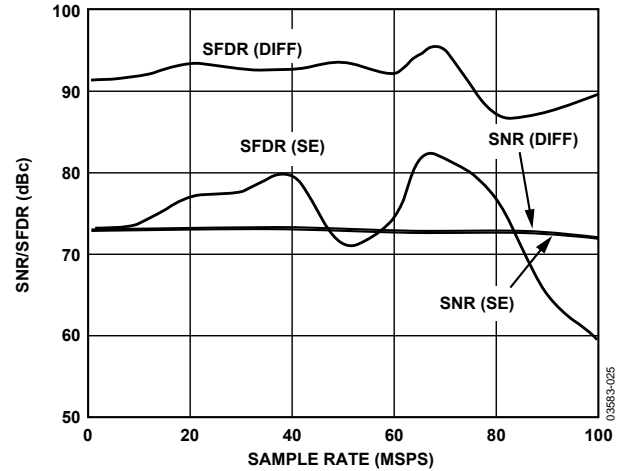

Figure 13. SNR/SFDR vs. Sample Rate @ 40 MHz

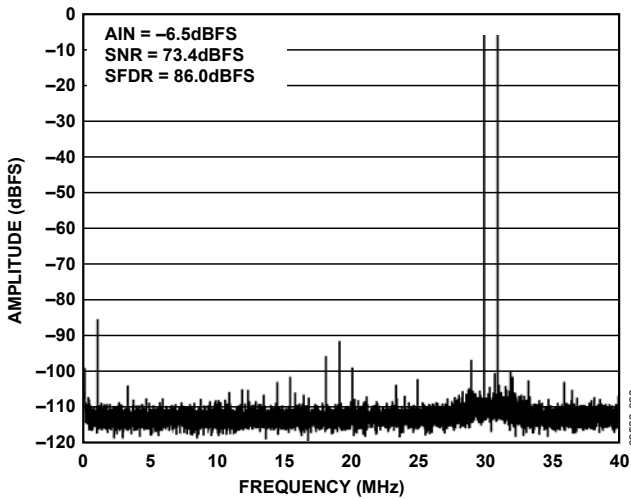

Figure 14. Two-Tone 8K FFT @ 30 MHz and 31 MHz

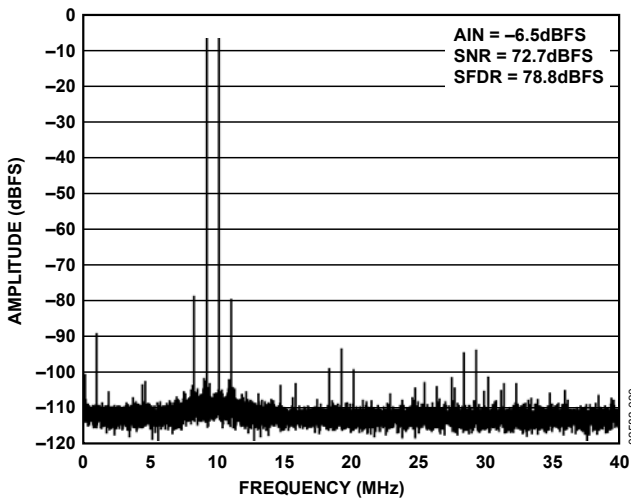

Figure 15. Two-Tone 8K FFT @ 69 MHz and 70 MHz

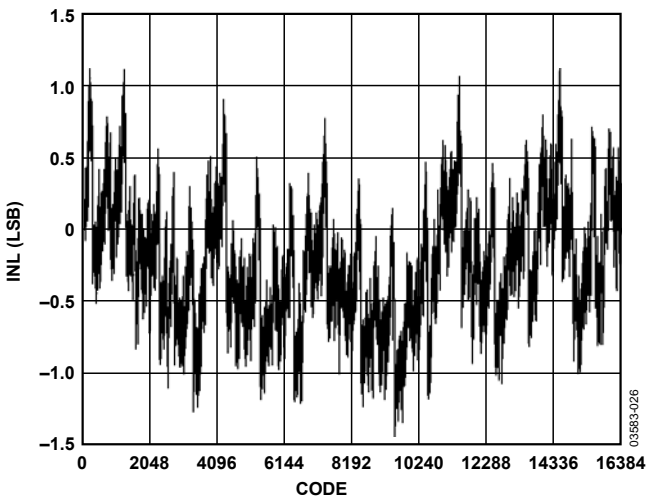

Figure 16. Typical INL

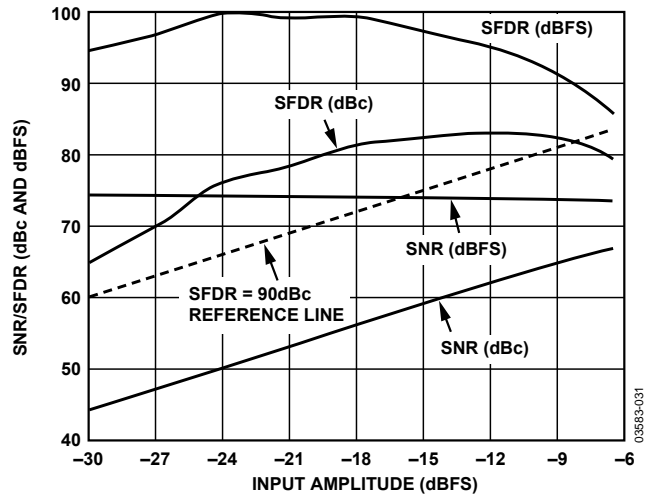

Figure 17. Two-Tone SNR/SFDR vs. Input Amplitude @ 30 MHz and 31 MHz

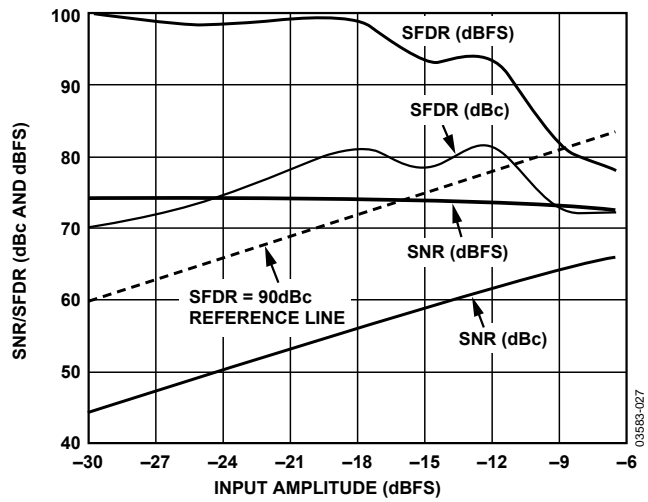

Figure 18. Two-Tone SNR/SFDR vs. Input Amplitude @ 69 MHz and 70 MHz

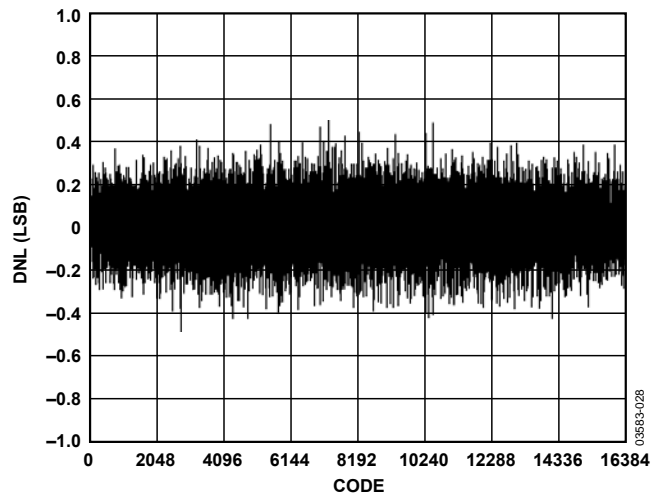

Figure 19. Typical DNL

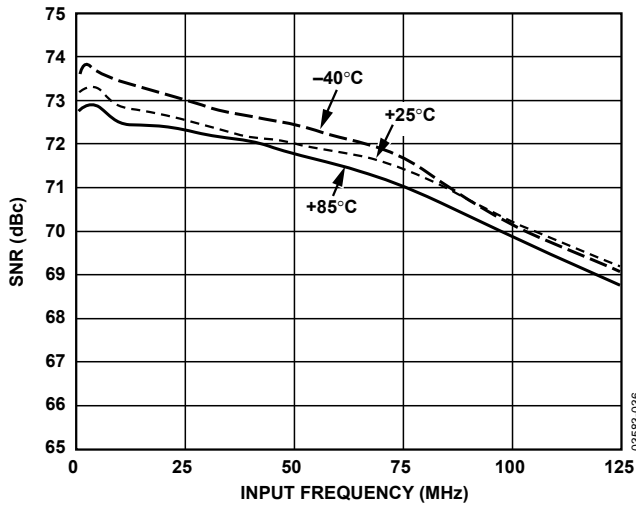

Figure 20. SNR vs. Input Frequency

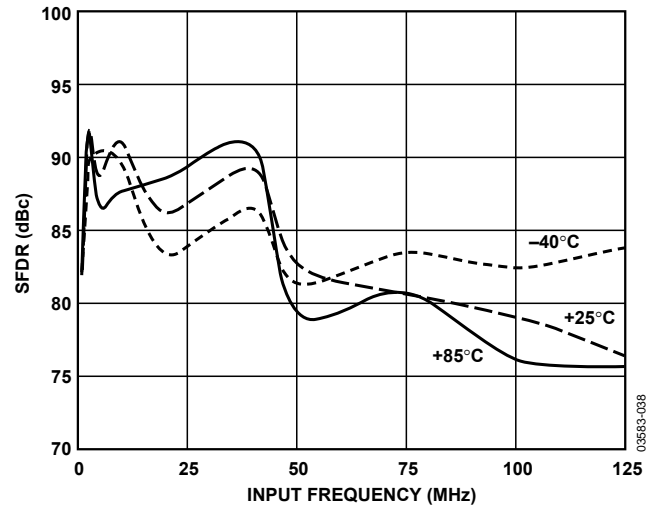

Figure 23. SFDR vs. Input Frequency

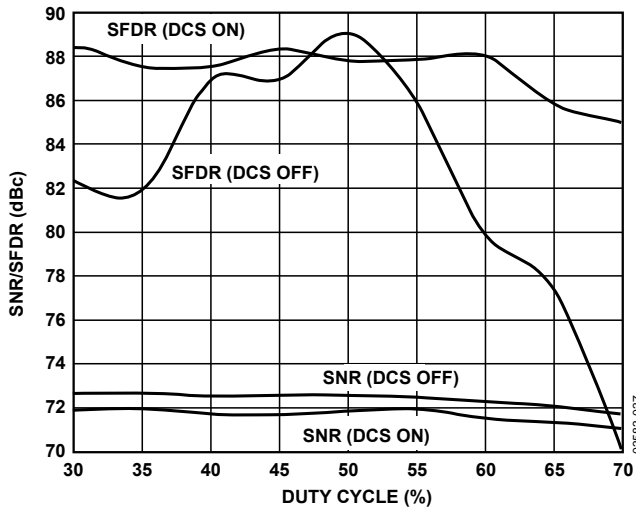

Figure 21. SNR/SFDR vs. Clock Duty Cycle

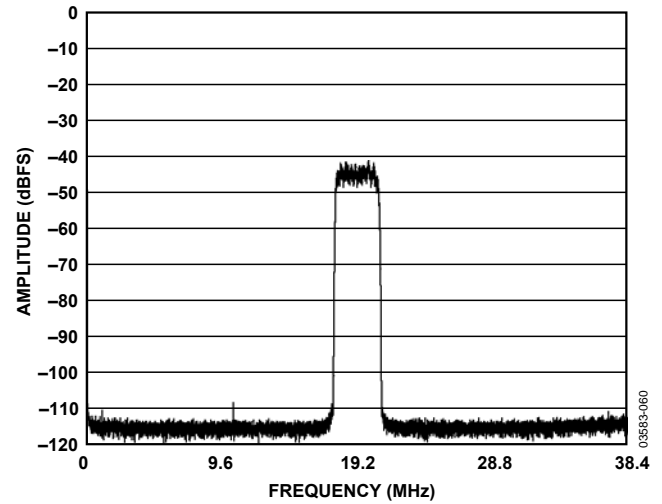

Figure 24. Two 32K FFT CDMA-2000 Carriers @  $F_{IN} = 46.08$  MHz; Sample Rate = 61.44 MSPS

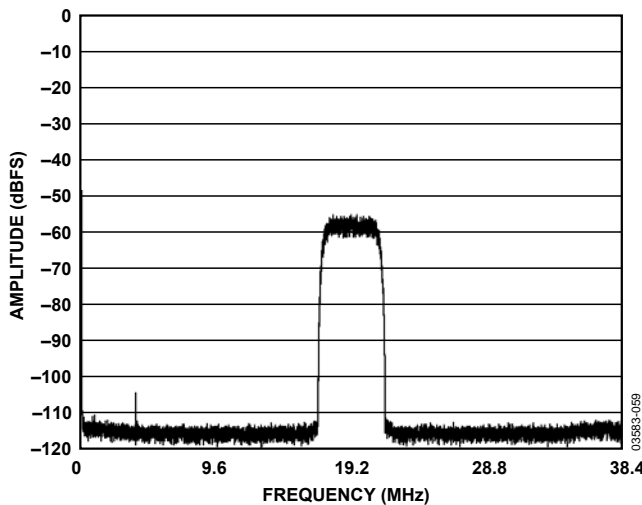

Figure 22. 32K FFT WCDMA Carrier @  $F_{IN} = 96$  MHz; Sample Rate = 76.8 MSPS

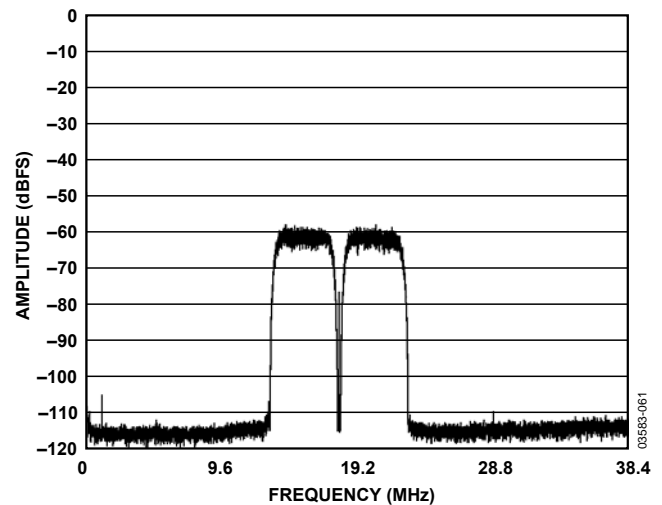

Figure 25. Two 32K FFT WCDMA Carriers @  $F_{IN} = 76.8$  MHz; Sample Rate = 61.44 MSPS

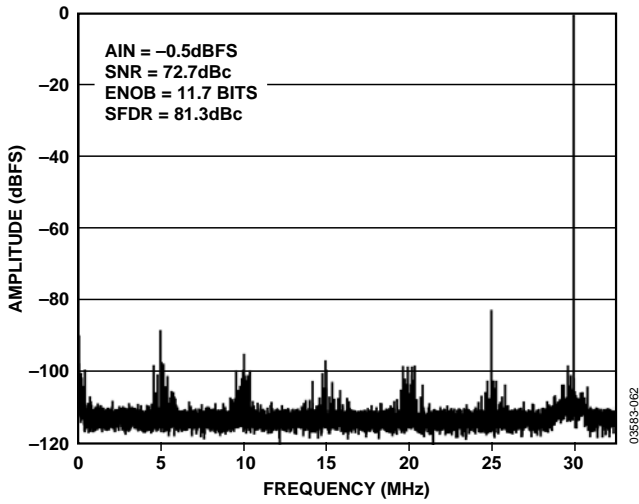

Figure 26. AD9245-65 Single Tone 16K FFT @ 35 MHz

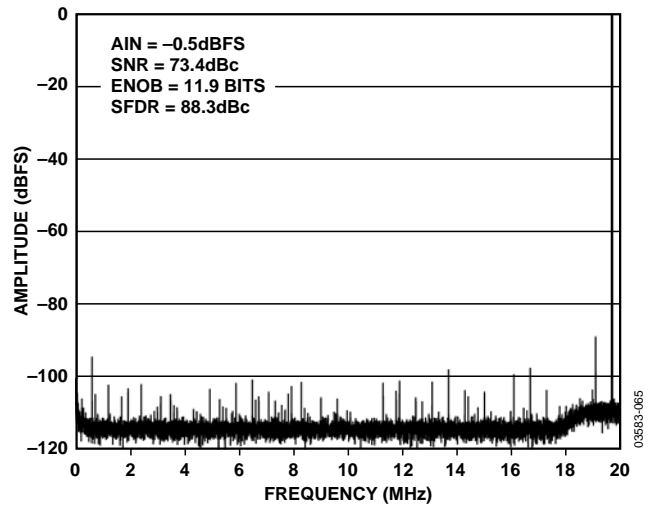

Figure 29. AD9245-40 Single Tone 16K FFT @ 19.7 MHz

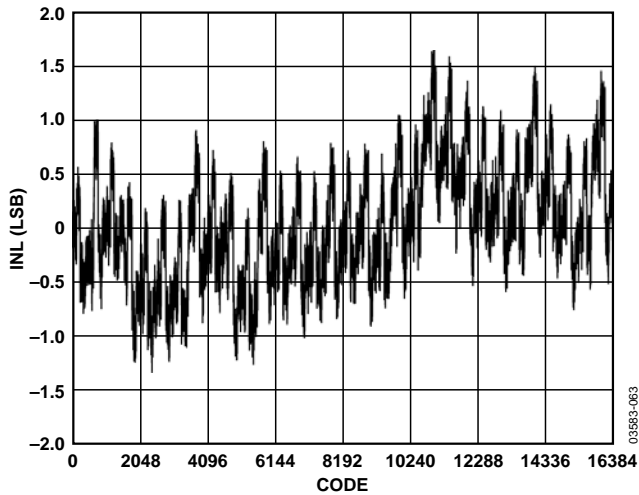

Figure 27. AD9245-65 Typical INL

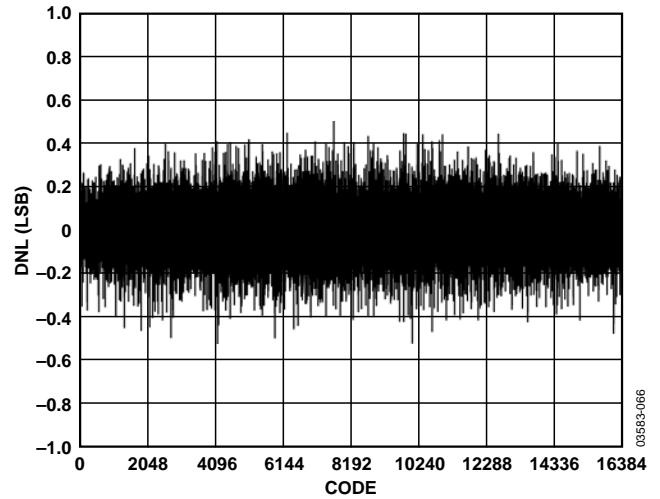

Figure 30. AD9245-65 Typical DNL

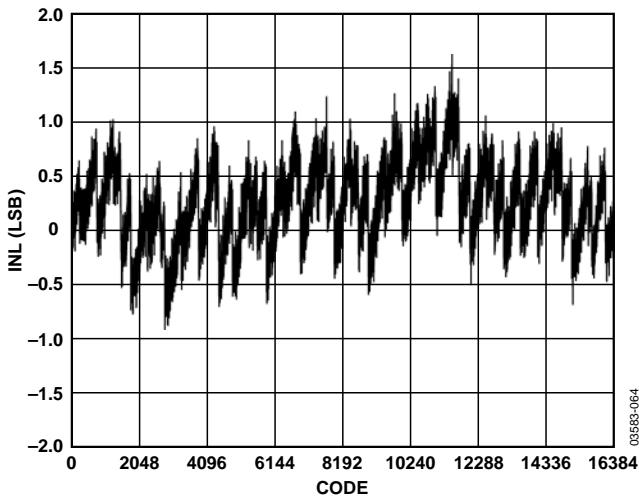

Figure 28. AD9245-40 Typical INL

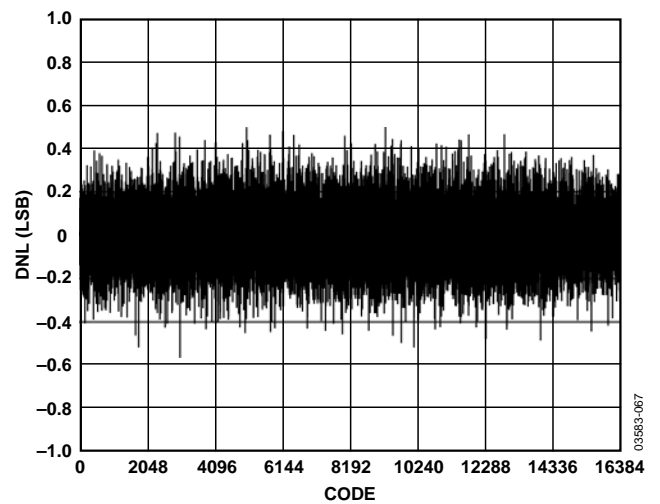

Figure 31. AD9245-40 Typical DNL

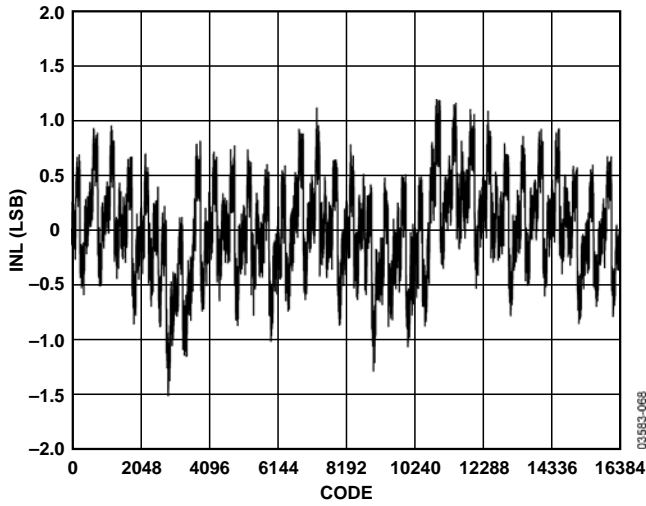

Figure 32. AD9245-20 Typical INL

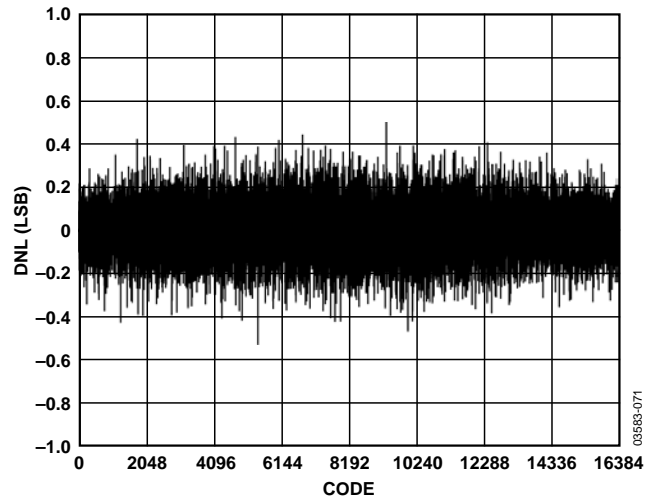

Figure 35. AD9245-20 Typical DNL

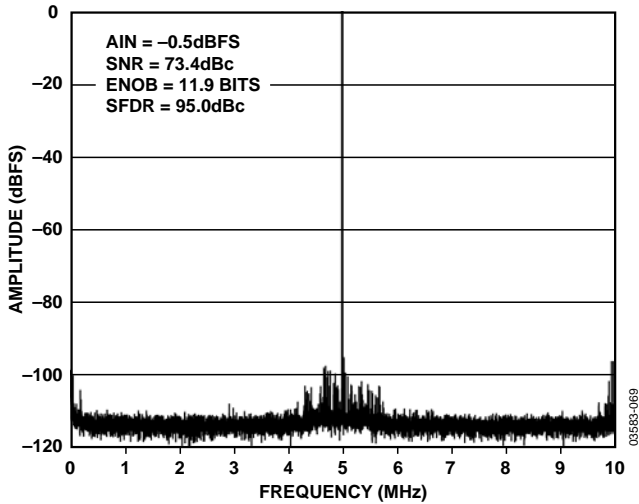

Figure 33. AD9245-20 Single Tone 16K FFT @ 5 MHz

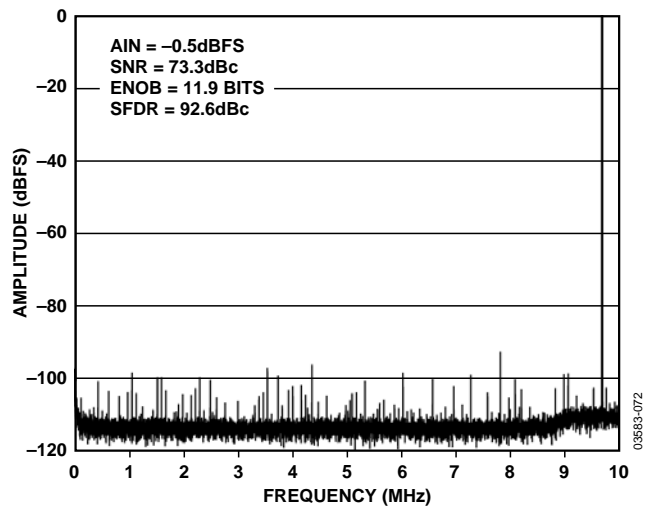

Figure 36. AD9245-20 Single Tone 16K FFT @ 9.7 MHz

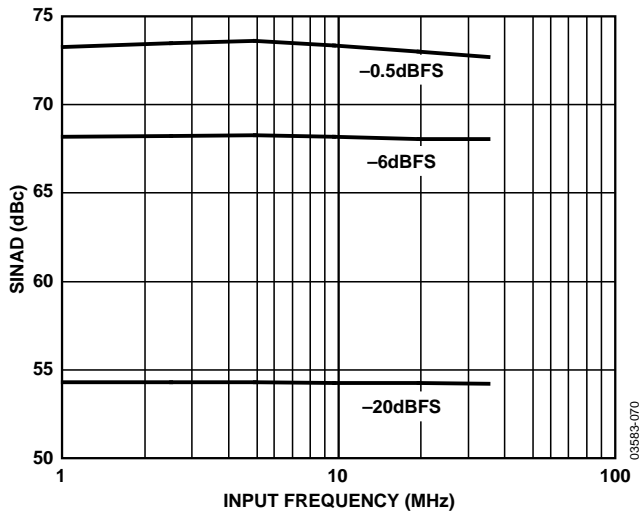

Figure 34. AD9245-20 SINAD vs. Input Frequency

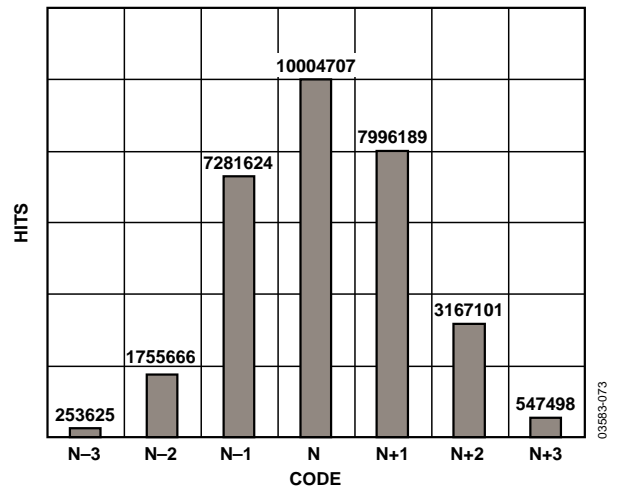

Figure 37. AD9245-20 Grounded-Input Histogram

## THEORY OF OPERATION

The AD9245 architecture consists of a front-end sample-and-hold amplifier (SHA) followed by a pipelined switched capacitor ADC. The pipelined ADC is divided into three sections consisting of a 4-bit first stage followed by eight 1.5-bit stages, and a final 3-bit flash. Each stage provides sufficient overlap to correct for flash errors in the preceding stages. The quantized outputs from each stage are combined into a final 14-bit result in the digital correction logic. The pipelined architecture permits the first stage to operate on a new input sample, while the remaining stages operate on preceding samples. Sampling occurs on the rising edge of the clock.

Each stage of the pipeline, excluding the last, consists of a low resolution flash ADC connected to a switched capacitor DAC and interstage residue amplifier (MDAC). The residue amplifier magnifies the difference between the reconstructed DAC output and the flash input for the next stage in the pipeline. One bit of redundancy is used in each stage to facilitate digital correction of flash errors. The last stage simply consists of a flash ADC.

The input stage contains a differential SHA that can be ac-coupled or dc-coupled in differential or single-ended modes. The output staging block aligns the data, carries out the error correction, and passes the data to the output buffers. The output buffers are powered from a separate supply, allowing adjustment of the output voltage swing. During power-down, the output buffers go into a high impedance state.

## ANALOG INPUT AND REFERENCE OVERVIEW

The analog input to the AD9245 is a differential switched-capacitor SHA that has been designed for optimum performance while processing a differential input signal. The SHA input can support a wide common-mode range (VCM) and maintain excellent performance, as shown in Figure 38. An input common-mode voltage of midsupply minimizes signal-dependent errors and provides optimum performance.

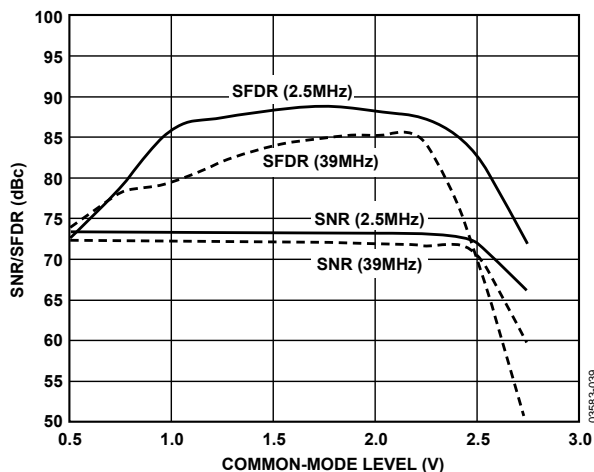

Figure 38. AD9245-80 SNR/SFDR vs. Common-Mode Level

Referring to Figure 39, the clock signal alternately switches the SHA between sample mode and hold mode. When the SHA is switched into sample mode, the signal source must be capable of charging the sample capacitors and settling within one-half of a clock cycle. A small resistor in series with each input can help reduce the peak transient current required from the output stage of the driving source. In addition, a small shunt capacitor can be placed across the inputs to provide dynamic charging currents. This passive network creates a low-pass filter at the ADC's input; therefore, the precise values are dependent upon the application. In IF undersampling applications, any shunt capacitors should be reduced or removed. In combination with the driving source impedance, they would limit the input bandwidth.

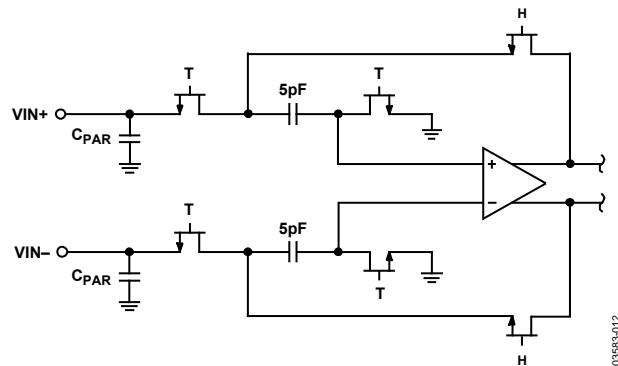

Figure 39. Switched-Capacitor SHA Input

For best dynamic performance, the source impedances driving VIN+ and VIN- should be matched such that common-mode settling errors are symmetrical. These errors are reduced by the common-mode rejection of the ADC.

An internal differential reference buffer creates positive and negative reference voltages, REFT and REFB, that define the span of the ADC core. The output common mode of the reference buffer is set to midsupply, and the REFT and REFB voltages and span are defined as:

$$REFT = \frac{1}{2} (AVDD + VREF)$$

$$REFB = \frac{1}{2} (AVDD - VREF)$$

$$Span = 2 \times (REFT - REFB) = 2 \times VREF$$

The previous equations show that the REFT and REFB voltages are symmetrical about the midsupply voltage, and, by definition, the input span is twice the value of the VREF voltage.

The internal voltage reference can be pin strapped to fixed values of 0.5 V or 1.0 V, or adjusted within the same range as discussed in the Internal Reference Connection section.

Maximum SNR performance is achieved with the AD9245 set to the largest input span of 2 V p-p. The relative SNR degradation is 3 dB when changing from 2 V p-p mode to 1 V p-p mode.

The SHA can be driven from a source that keeps the signal peaks within the allowable range for the selected reference voltage. The minimum and maximum common-mode input levels are defined as

$$V_{CM\_MIN} = \frac{V_{REF}}{2}$$

$$V_{CM\_MAX} = \frac{(AVDD + V_{REF})}{2}$$

The minimum common-mode input level allows the AD9245 to accommodate ground referenced inputs.

Although optimum performance is achieved with a differential input, a single-ended source can be applied to VIN+ or VIN-. In this configuration, one input accepts the signal, while the opposite input is set to midscale by connecting it to an appropriate reference. For example, a 2 V p-p signal can be applied to VIN+ while a 1 V reference is applied to VIN-. The AD9245 then accepts an input signal varying between 2 V and 0 V. In the single-ended configuration, distortion performance can degrade significantly as compared to the differential case. However, the effect is less noticeable at lower input frequencies.

**Differential Input Configurations**

As previously detailed, optimum performance is achieved while driving the AD9245 in a differential input configuration. For baseband applications, the AD8351 differential driver provides excellent performance and a flexible interface to the ADC. The output common-mode voltage of the AD8351 is easily set to AVDD/2, and the driver can be configured in a Sallen-Key filter topology to provide band limiting of the input signal.

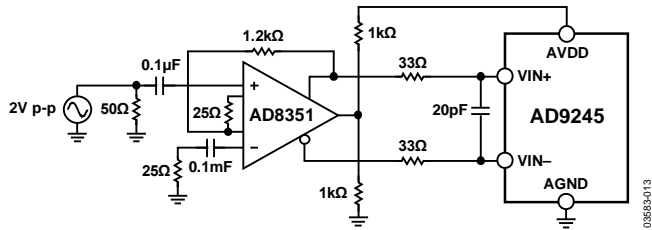

Figure 40. Differential Input Configuration Using the AD8351

At input frequencies in the second Nyquist zone and above, the performance of most amplifiers is not adequate to achieve the true performance of the AD9245. This is especially true in IF undersampling applications where frequencies in the 70 MHz to 100 MHz range are being sampled. For these applications, differential transformer coupling is the recommended input configuration. The value of the shunt capacitor is dependent on the input frequency and source impedance and should be reduced or removed. An example is shown in Figure 41.

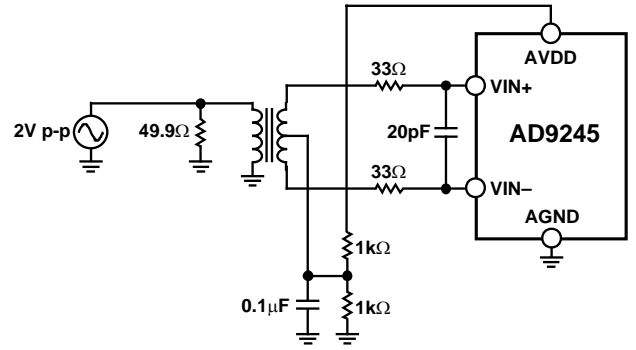

Figure 41. Differential Transformer-Coupled Configuration

The signal characteristics must be considered when selecting a transformer. Most RF transformers saturate at frequencies below a few MHz, and excessive signal power can also cause core saturation, which leads to distortion.

**Single-Ended Input Configuration**

A single-ended input can provide adequate performance in cost-sensitive applications. In this configuration, there is a degradation in SFDR and distortion performance due to the large input common-mode swing (see Figure 13). However, if the source impedances on each input are matched, there should be little effect on SNR performance. Figure 42 details a typical single-ended input configuration.

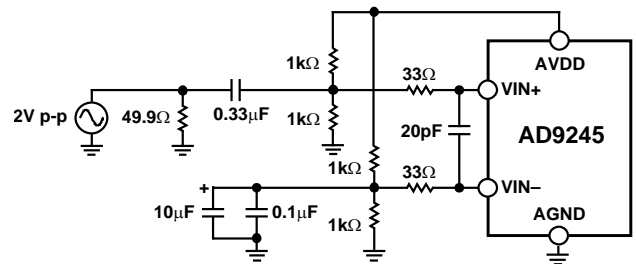

Figure 42. Single-Ended Input Configuration

**CLOCK INPUT CONSIDERATIONS**

Typical high speed ADCs use both clock edges to generate a variety of internal timing signals, and as a result can be sensitive to clock duty cycle. Commonly a 5% tolerance is required on the clock duty cycle to maintain dynamic performance characteristics. The AD9245-80 and AD9245-65 contain a clock duty cycle stabilizer (DCS) that retimes the nonsampling edge, providing an internal clock signal with a nominal 50% duty cycle. This allows a wide range of clock input duty cycles without affecting the performance of the AD9245. As shown in Figure 21, noise and distortion performance is nearly flat for a 30% to 70% duty cycle with the DCS on.

The duty cycle stabilizer uses a delay-locked loop (DLL) to create the nonsampling edge. As a result, any changes to the sampling frequency require approximately 100 clock cycles to allow the DLL to acquire and lock to the new rate.

## JITTER CONSIDERATIONS

High speed, high resolution ADCs are sensitive to the quality of the clock input. The degradation in SNR at a given input frequency ( $f_{INPUT}$ ) due only to aperture jitter ( $t_j$ ) can be calculated with the following equation:

$$SNR = -20 \log_{10}[2\pi f_{INPUT} \times t_j]$$

In the equation, the rms aperture jitter represents the root-mean square of all jitter sources, which include the clock input, analog input signal, and ADC aperture jitter specification. IF undersampling applications are particularly sensitive to jitter (see Figure 43).

The clock input should be treated as an analog signal in cases where aperture jitter can affect the dynamic range of the AD9245. Power supplies for clock drivers should be separated from the ADC output driver supplies to avoid modulating the clock signal with digital noise. Low jitter, crystal-controlled oscillators make the best clock sources. If the clock is generated from another type of source (by gating, dividing, or other methods), it should be retimed by the original clock at the last step.

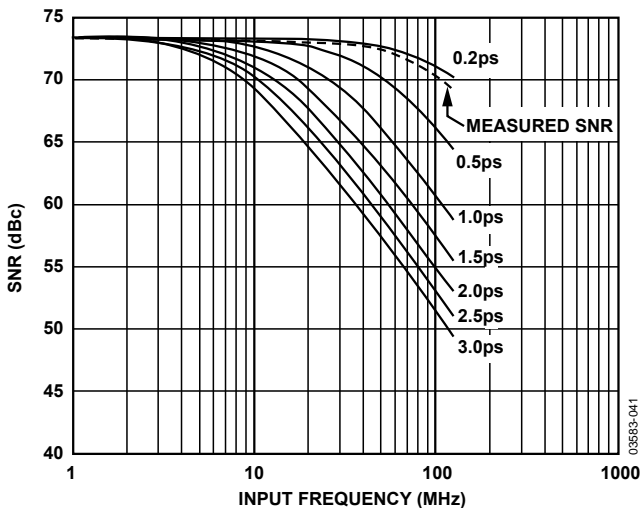

Figure 43. SNR vs. Input Frequency and Jitter

## POWER DISSIPATION AND STANDBY MODE

As shown in Figure 44, the power dissipated by the AD9245 is proportional to its sample rate. The digital power dissipation is determined primarily by the strength of the digital drivers and the load on each output bit. The maximum DRVDD current ( $I_{DRVDD}$ ) can be calculated as

$$I_{DRVDD} = V_{DRVDD} \times C_{LOAD} \times f_{CLK} \times N$$

where  $N$  is the number of output bits, 14 in the case of the AD9245. This maximum current occurs when every output bit switches on every clock cycle, that is, a full-scale square wave at the Nyquist frequency,  $f_{CLK}/2$ . In practice, the DRVDD current is established by the average number of output bits switching,

which is determined by the sample rate and the characteristics of the analog input signal.

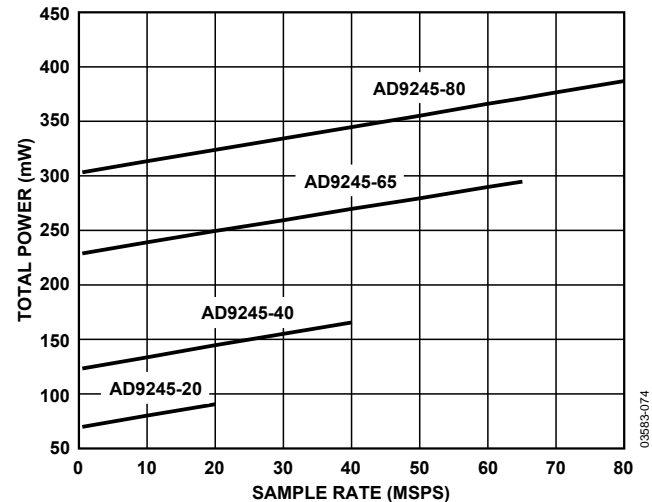

Figure 44. AD9245 Power vs. Sample Rate @ 2.5 MHz

Reducing the capacitive load presented to the output drivers can minimize digital power consumption. The data in Figure 44 was taken with the same operating conditions as those reported in the Typical Performance Characteristics section, and with a 5 pF load on each output driver.

By asserting the PDWN pin high, the AD9245 is placed in standby mode. In this state, the ADC typically dissipates 1 mW if the CLK and analog inputs are static. During standby, the output drivers are placed in a high impedance state. Reasserting the PDWN pin low returns the AD9245 to its normal operational mode.

Low power dissipation in standby mode is achieved by shutting down the reference, reference buffer, and biasing networks. The decoupling capacitors on REFT and REFB are discharged when entering standby mode and then must be recharged when returning to normal operation. As a result, the wake-up time is related to the time spent in standby mode, and shorter standby cycles result in proportionally shorter wake-up times. With the recommended 0.1  $\mu$ F and 10  $\mu$ F decoupling capacitors on REFT and REFB, it takes approximately 1 second to fully discharge the reference buffer decoupling capacitors and 7 ms to restore full operation.

## DIGITAL OUTPUTS

The AD9245 output drivers can be configured to interface with 2.5 V or 3.3 V logic families by matching DRVDD to the digital supply of the interfaced logic. The output drivers are sized to provide sufficient output current to drive a wide variety of logic families. However, large drive currents tend to cause current glitches on the supplies, which can affect converter performance. Applications requiring the ADC to drive large capacitive loads or large fanouts can require external buffers or latches.

As detailed in Table 11, the data format can be selected for either offset binary or twos complement.

**TIMING**

The AD9245 provides latched data outputs with a pipeline delay of seven clock cycles. Data outputs are available one propagation delay ( $t_{PD}$ ) after the rising edge of the clock signal. Refer to Figure 2 for a detailed timing diagram.

The length of the output data lines and the loads placed on them should be minimized to reduce transients within the AD9245. These transients can degrade the converter’s dynamic performance.

The lowest typical conversion rate of the AD9245 is 1 MSPS. At clock rates below 1 MSPS, dynamic performance can degrade.

**VOLTAGE REFERENCE**

A stable and accurate 0.5 V voltage reference is built into the AD9245. The input range can be adjusted by varying the reference voltage applied to the AD9245 using either the internal reference or an externally applied reference voltage. The input span of the ADC tracks reference voltage changes linearly. The various reference modes are summarized in Table 10 and described in the following sections.

If the ADC is being driven differentially through a transformer, the reference voltage can be used to bias the center tap (common-mode voltage).

**INTERNAL REFERENCE CONNECTION**

A comparator within the AD9245 detects the potential at the SENSE pin and configures the reference into one of four possible states, which are summarized in Table 10. If SENSE is grounded, the reference amplifier switch is connected to the internal resistor divider (see Figure 45), setting VREF to 1 V. Connecting the SENSE pin to VREF switches the reference amplifier output to the SENSE pin, completing the loop and providing a 0.5 V reference output. If a resistor divider is connected as shown in Figure 47, the switch is again set to the SENSE pin. This puts the reference amplifier in a noninverting mode with the VREF output defined as

$$VREF = 0.5 \times \left( 1 + \frac{R2}{R1} \right)$$

In all reference configurations, REFT and REFB drive the A/D conversion core and establish its input span. The input range of the ADC always equals twice the voltage at the reference pin for either an internal or an external reference.

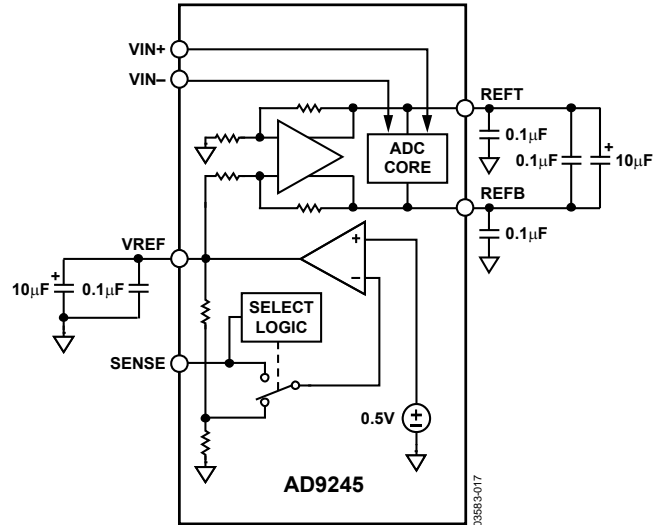

Figure 45. Internal Reference Configuration

If the internal reference of the AD9245 is used to drive multiple converters to improve gain matching, the loading of the reference by the other converters must be considered. Figure 46 depicts how the internal reference voltage is affected by loading. A 2 mA load is the maximum recommended load.

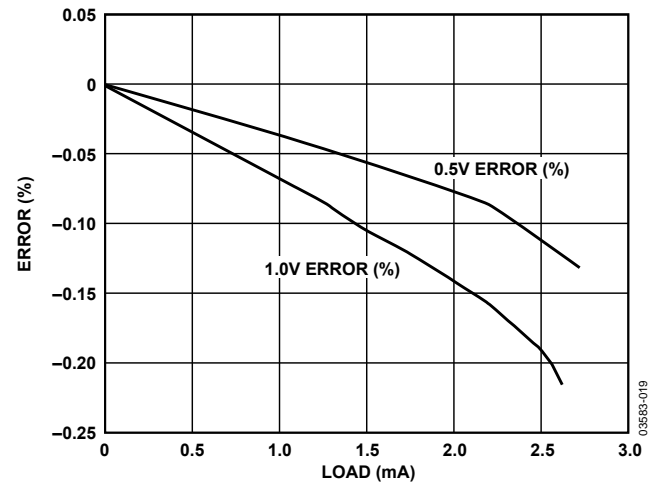

Figure 46. VREF Accuracy vs. Load

Table 10. Reference Configuration Summary

Selected Mode	SENSE Voltage	Resulting VREF (V)	Resulting Differential Span (V p-p)
External Reference	AVDD	N/A	2 × External Reference
Internal Fixed Reference	VREF	0.5	1.0
Programmable Reference	0.2 V to VREF	$0.5 \times \left( 1 + \frac{R2}{R1} \right)$ (See Figure 47)	2 × VREF
Internal Fixed Reference	AGND to 0.2 V	1.0	2.0

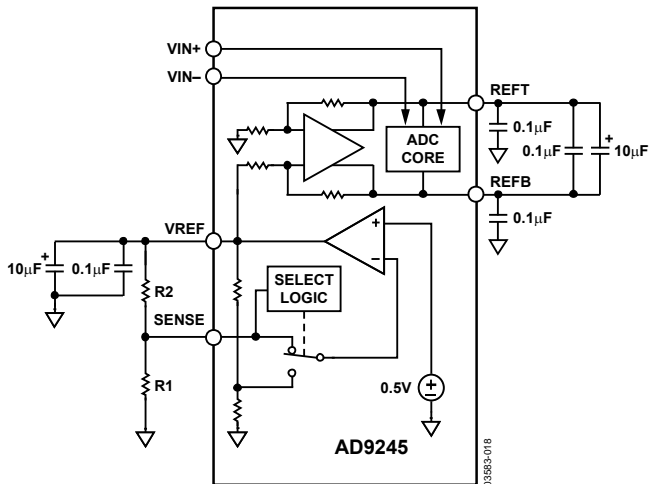

Figure 47. Programmable Reference Configuration

## EXTERNAL REFERENCE OPERATION

The use of an external reference can be necessary to enhance the gain accuracy of the ADC or improve thermal drift characteristics. When multiple ADCs track one another, a single reference (internal or external) can be necessary to reduce gain matching errors to an acceptable level. Figure 48 shows the typical drift characteristics of the internal reference in both 1.0 V and 0.5 V modes.

When the SENSE pin is tied to AVDD, the internal reference is disabled, allowing the use of an external reference. An internal reference buffer loads the external reference with an equivalent 7 kΩ load. The internal buffer still generates the positive and negative full-scale references, REFT and REF B, for the ADC core. The input span is always twice the value of the reference voltage; therefore, the external reference must be limited to a maximum of 1.0 V.

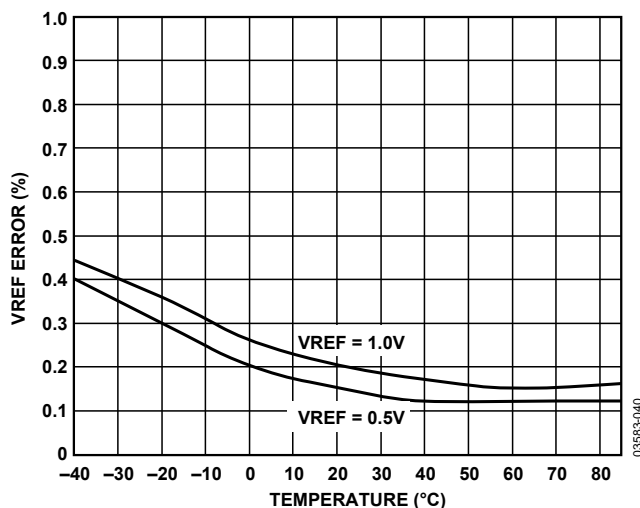

Figure 48. Typical VREF Drift

## OPERATIONAL MODE SELECTION

As discussed earlier, the AD9245 can output data in either offset binary or twos complement format. There is also a provision for enabling or disabling the clock DCS. The MODE pin is a multilevel input that controls the data format and DCS state. The input threshold values and corresponding mode selections are outlined in Table 11.

Table 11. Mode Selection

MODE Voltage	Data Format	Duty Cycle Stabilizer
AVDD	Twos Complement	Disabled
2/3 AVDD	Twos Complement	Enabled
1/3 AVDD	Offset Binary	Enabled
AGND (Default)	Offset Binary	Disabled

## EVALUATION BOARD

The AD9245 evaluation board provides the support circuitry required to operate the ADC in its various modes and configurations. Complete schematics and layout plots follow and demonstrate the proper routing and grounding techniques that should be applied at the system level.

It is critical that signal sources with very low phase noise (<1 ps rms jitter) be used to realize the ultimate performance of the converter. Proper filtering of the input signal, to remove harmonics and lower the integrated noise at the input, is also necessary to achieve the specified noise performance.

The AD9245 can be driven single-ended or differentially through a transformer. Separate power pins are provided to isolate the DUT from the support circuitry. Each input configuration can be selected by proper connection of various jumpers (refer to the schematics).

An alternative differential analog input path using an AD8351 op amp is included in the layout but is not populated in production. Designers interested in evaluating the op amp with the ADC should remove C15, R12, and R3 and populate the op amp circuit. The passive network between the AD8351 outputs and the AD9245 allows the user to optimize the frequency response of the op amp for the application.

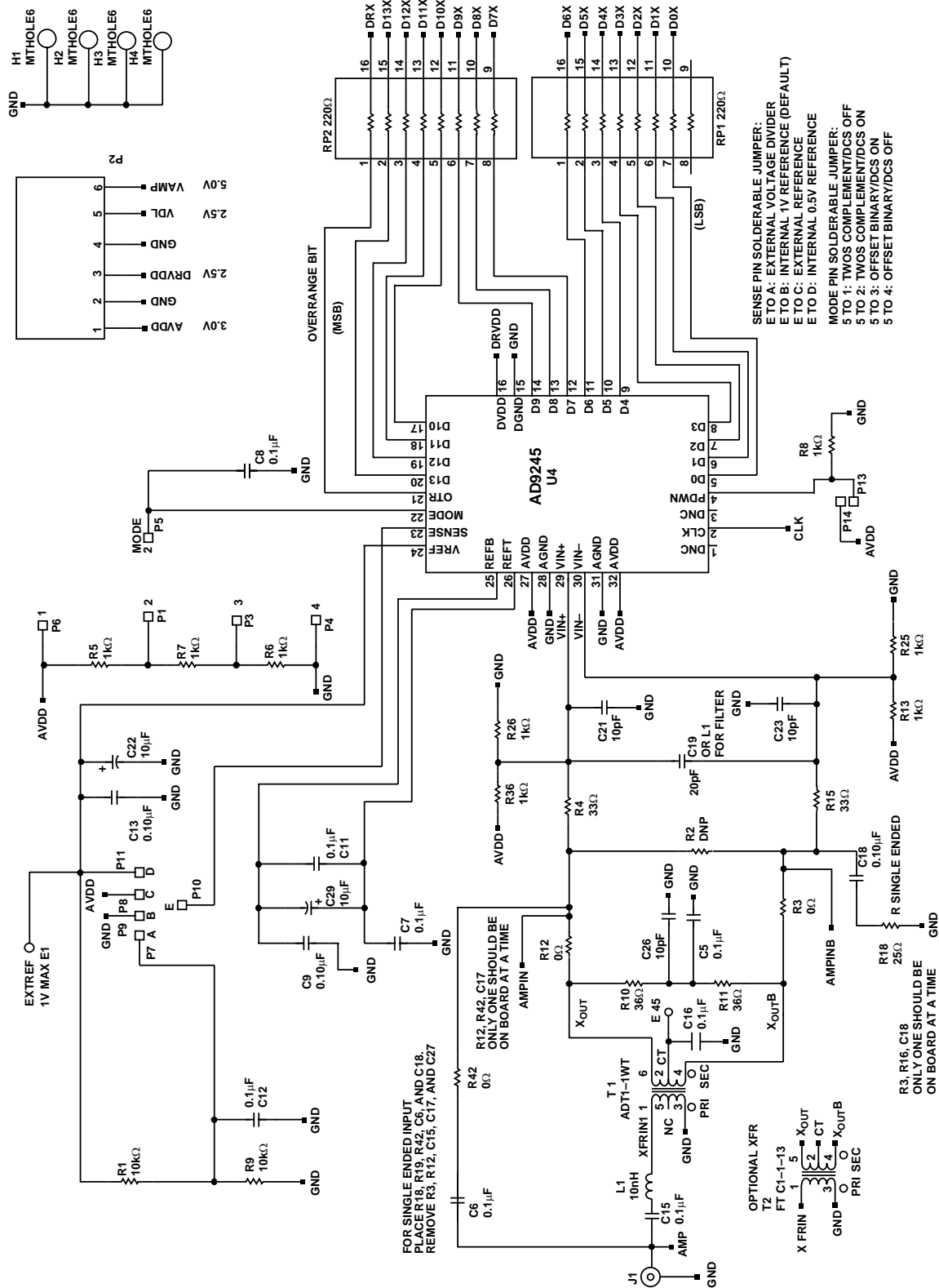

Figure 49. LFCSP Evaluation Board Schematic—Analog Inputs and DUT

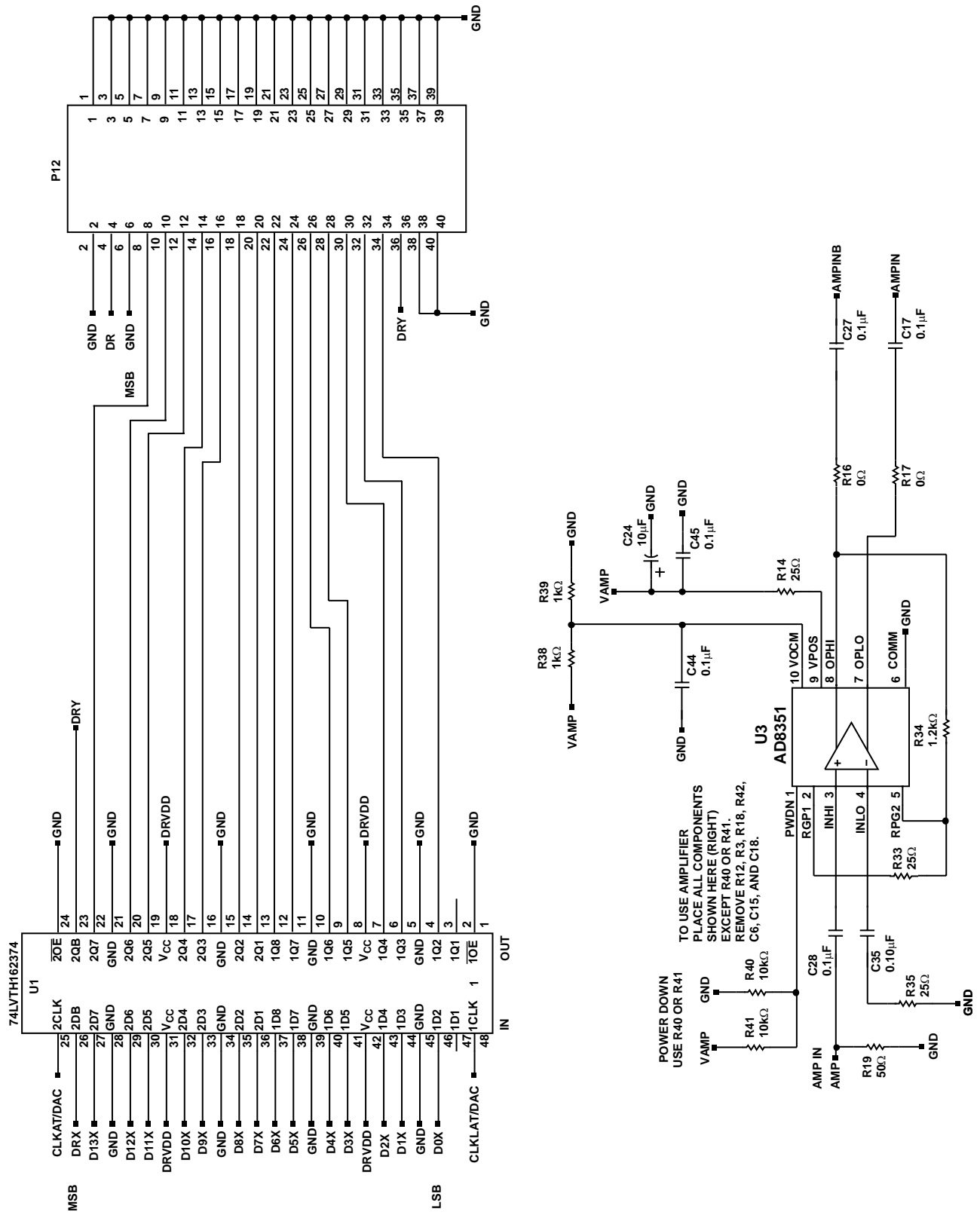

Figure 50. LFCSP Evaluation Board Schematic—Digital Path

03583-051

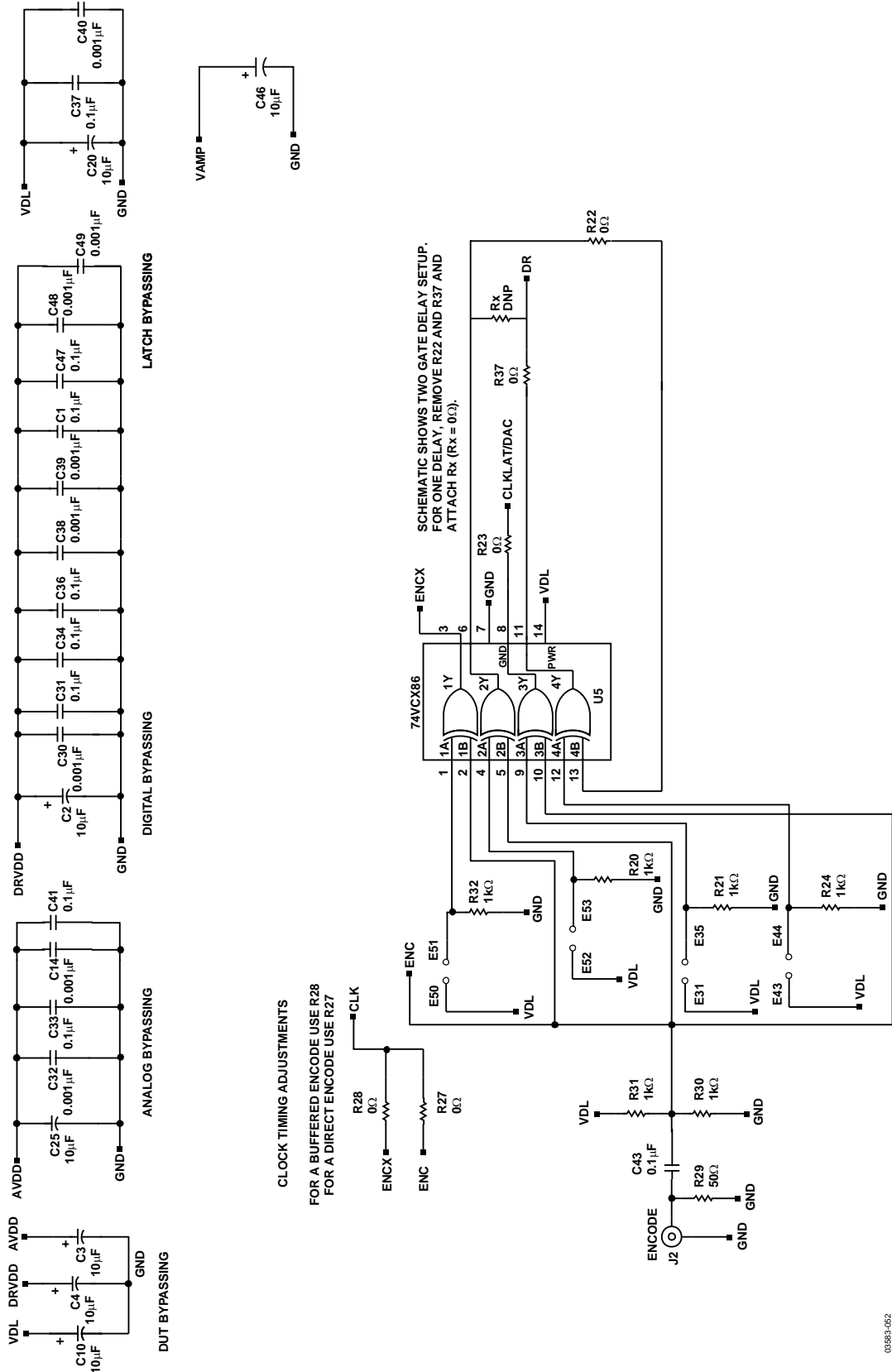

Figure 51. LFCSP Evaluation Board Schematic—Clock Input

00963-062

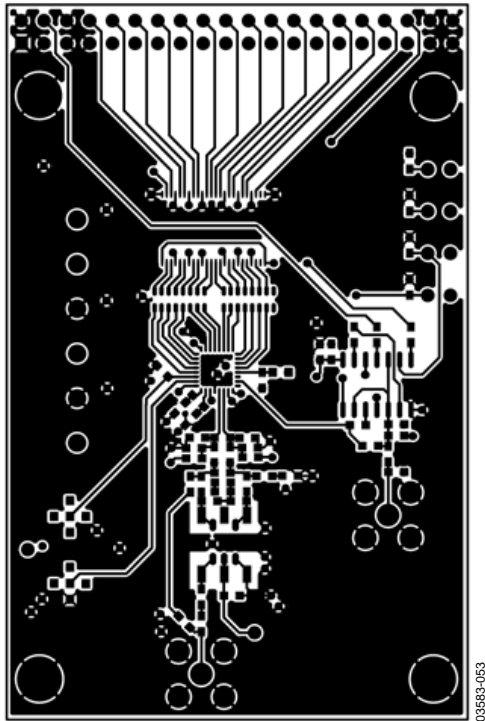

Figure 52. LFCSP Evaluation Board Layout, Primary Side

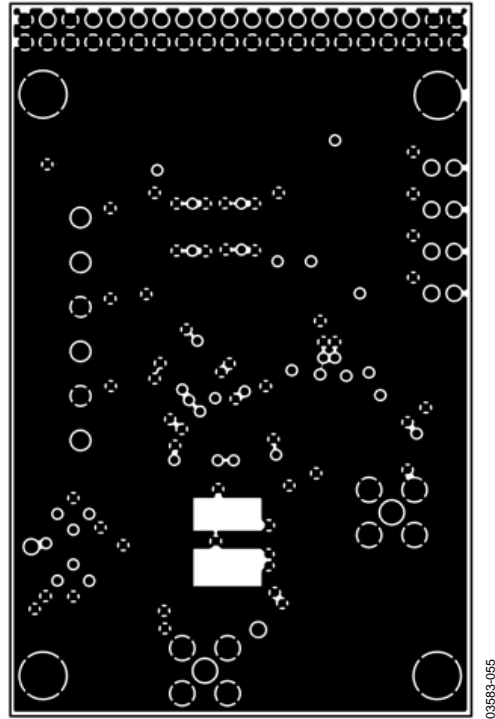

Figure 54. LFCSP Evaluation Board Layout, Ground Plane

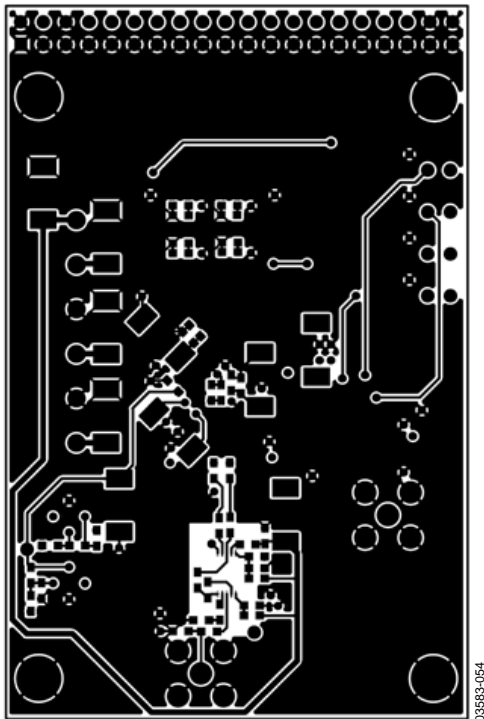

Figure 53. LFCSP Evaluation Board Layout, Secondary Side

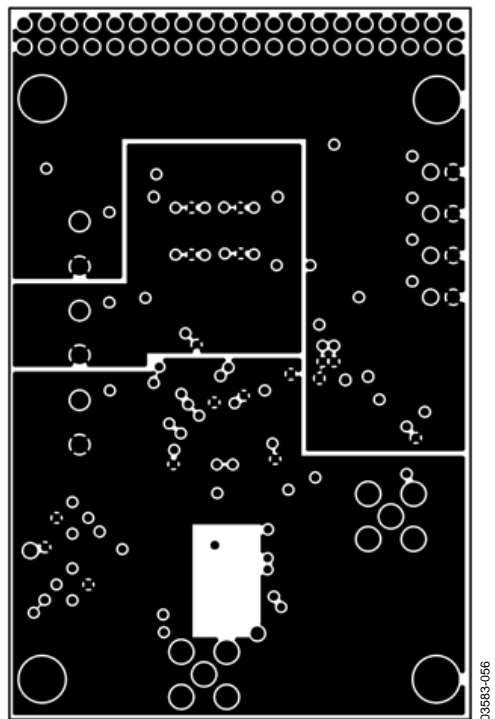

Figure 55. LFCSP Evaluation Board Layout, Power Plane

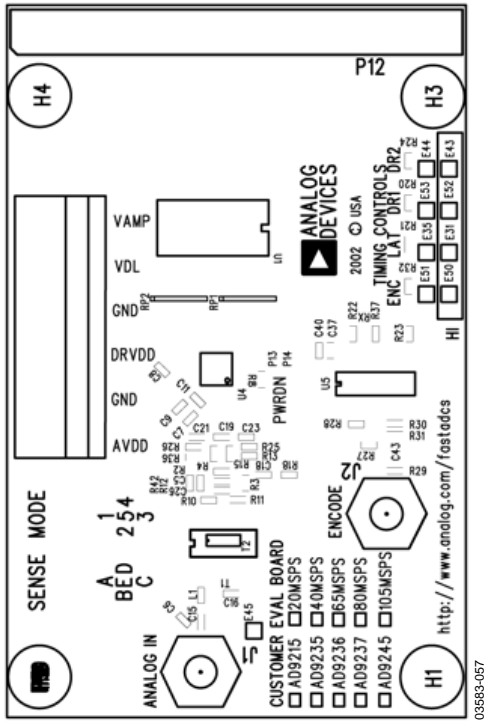

Figure 56. LFCSP Evaluation Board Layout, Primary Silkscreen

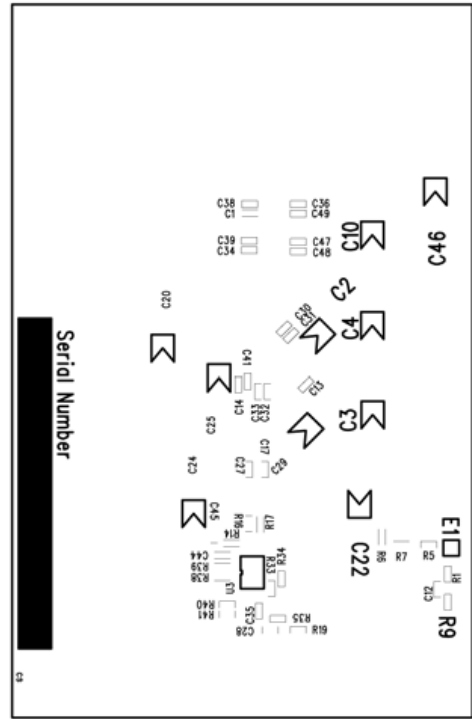

Figure 57. LFCSP Evaluation Board Layout, Secondary Silkscreen

Table 12. LFCSP Evaluation Board Bill of Materials

Item	Qty.	Omit <sup>1</sup>	Reference Designator	Device	Package	Value	Recommended Vendor/Part No.	Supplied by ADI
1	18		C1, C5, C7, C8, C9, C11, C12, C13, C15, C16, C31, C33, C34, C36, C37, C41, C43, C47	Chip Capacitors	0603	0.1 $\mu$ F		
		8	C6, C17, C18, C27, C28, C35, C45, C44					
2	8		C2, C3, C4, C10, C20, C22, C25, C29	Tantalum Capacitors	TAJC	10 $\mu$ F		
		2	C24, C46					
3	8		C14, C30, C32, C38, C39, C40, C48, C49	Chip Capacitors	0603	0.001 $\mu$ F		
4	1		C19	Chip Capacitors	0603	20 pF		
5	1		C26	Chip Capacitors	0603	10 pF		
		2	C21, C23					
6	9		E31, E35, E43, E44, E50, E51, E52, E53	Headers	EHOLE		Jumper Blocks	
		2	E1, E45					
7	2		J1, J2	SMA Connectors/50 $\Omega$	SMA			
8	1		L1	Inductor	0603	10 nH	Coilcraft/ 0603CS-10NXGBU	
9	1		P2	Terminal Block	TB6		Wieland/25.602.2653.0, z5-530-0625-0	
10	1		P12	Header Dual 20-Pin RT Angle	HEADER40		Digi-Key S2131-20-ND	
11	5		R3, R12, R23, R28, Rx	Chip Resistors	0603	0 $\Omega$		
		6	R16, R17, R22, R27, R42, R37					
12	2		R4, R15	Chip Resistors	0603	33 $\Omega$		
13	14		R5, R6, R7, R8, R13, R20, R21, R24, R25, R26, R30, R31, R32, R36	Chip Resistors	0603	1 k $\Omega$		
14	2		R10, R11	Chip Resistors	0603	36 $\Omega$		
15	1		R29	Chip Resistors	0603	50 $\Omega$		
		1	R19					
16	2		RP1, RP2	Resistor Packs	R_742	220 $\Omega$	Digi-Key CTS/742C163221JTR	
17	1		T1	ADT1-1WT	AWT1-1T		Mini-Circuits	
18	1		U1	74LVTH162374 CMOS Register	TSSOP-48			
19	1		U4	AD9245BCP ADC (DUT)	LFCSP-32		Analog Devices, Inc.	X
20	1		U5	74VXC86M	SOIC-14		Fairchild	
21	1		PCB	AD92XXBCP/PCB	PCB		Analog Devices, Inc.	X
22	1		U3	AD8351 Op Amp	MSOP-8		Analog Devices, Inc.	X
23	1		T2	M/A-COM Transformer	ETC1-1-13	1-1 TX	M/A-COM/ETC1-1-13	
24	5		R1, R2, R9, R38, R39	Chip Resistors	0603	SELECT		
25	3		R14, R18, R35	Chip Resistors	0603	25 $\Omega$		
26	2		R40, R41	Chip Resistors	0603	10 k $\Omega$		
27	1		R34	Chip Resistor		1.2 k $\Omega$		
28	1		R33	Chip Resistor		25 $\Omega$		
<b>Total</b>	81	35						

<sup>1</sup> These items are included in the PCB design, but are omitted at assembly.



**NOTES**

**NOTES**

**NOTES**

## Looking for pricing, stock, or lifecycle information?

Click below to explore more details on WIN SOURCE:

 [View AD9245BCPZRL7-20 on WIN SOURCE](#)

 [Analog Devices Inc. Information](#)

## Optimize Your Supply Chain with WIN SOURCE Solutions

-  Global Sourcing Solution
-  Obsolete Management
-  Cost Control Management
-  Shortage Management
-  Alternative Solution
-  Excess Inventory Management