



**THE DATASHEET OF
RTQ2569-33GQW-QA**



36V, 2 μ A I_Q, Peak 200mA, Low Dropout Voltage Linear Regulator

General Description

The RTQ2569 is a high input voltage (36V), low quiescent current (2 μ A), low-dropout linear regulator (LDO) capable of sourcing peak 200mA. The device supports high input voltage with few component makes it easy to use.

The high input voltage, low dropout voltage, ultra-low quiescent current, and miniaturized package as low as 2 μ A, the RTQ2569 is ideally suited for automotive and other battery operated system.

The RTQ2569 retains all of the features that are common to low-dropout, short circuit protection and thermal operation.

The RTQ2569 has 36V maximum operating voltage limit -40°C to 125°C operating temperature range.

The RTQ2569 is available in WDFN-8L 3x3 package.

Applications

- Automotive
- Always On Power
- Portable, Battery Powered Equipments
- Extra Low Voltage Microcontrollers
- Notebook Computers
- E-Meters
- Handset Peripherals

Note :

Richtek products are :

- ▶ RoHS compliant and compatible with the current requirements of IPC/JEDEC J-STD-020.
- ▶ Suitable for use in SnPb or Pb-free soldering processes.

Features

- AEC-Q100 Grade 1 Qualified
- Ultra low Quiescent Current 2 μ A (typ.)
- \pm 2% Output Accuracy
- 100mA Continuous Output Current
- Operating Input Voltage : 3.5V to 36V
- Low dropout voltage : 200mV at 10mA
- Fixed Output Voltage : 2.5V to 12V with 0.1V Per Step
- Current Limit Protection
- Over-Temperature Protection
- RoHS Compliant and Halogen Free

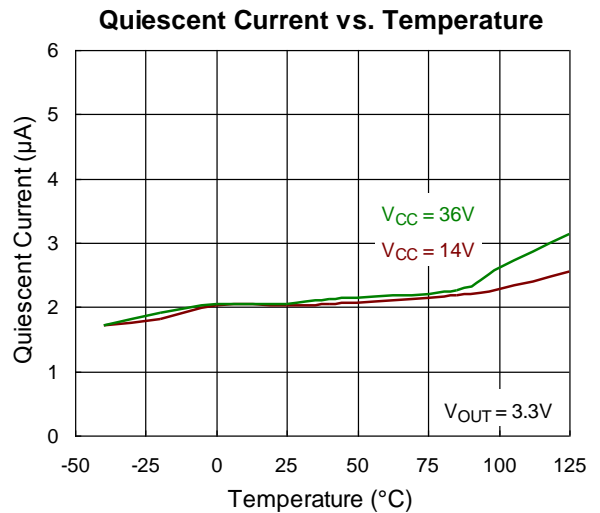

Ordering Information

RTQ2569-□□□□-QA

- Grade
QA : AEC-Q100 Qualified and Screened by High Temperature
- Package Type
QW : WDFN-8L 3x3 (W-Type)
- Lead Plating System
G : Green (Halogen Free and Pb Free)
- Output Voltage
25 : 2.5V
30 : 3V
33 : 3.3V
50 : 5V
70 : 7V
80 : 8V
90 : 9V
C0 : 12V
Special Request: Any Voltage between 2.5V and 12V under specific business agreement

Pin Configuration

(TOP VIEW)

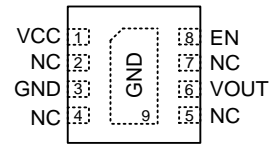

WDFN-8L 3x3

Marking Information

For marking information, contact our sales representative directly or through a Richtek distributor located in your area.

Functional Pin Description

Pin No.	Pin Name	Pin Function
1	VCC	Power input. The input voltage range is from 3.5V to 36V. Connect a suitable input capacitor between this pin and GND, usually 1μF ceramic capacitors.
2, 4, 5, 7	NC	No internal connection.
3, 9 (Exposed Pad)	GND	Ground. The exposed pad must be soldered to a large PCB and connected to GND for maximum thermal dissipation.
6	VOUT	Output of the regulator.
8	EN	Enable control input. A logic-high enables the converter; a logic-low forces the device into shutdown mode.

Functional Block Diagram

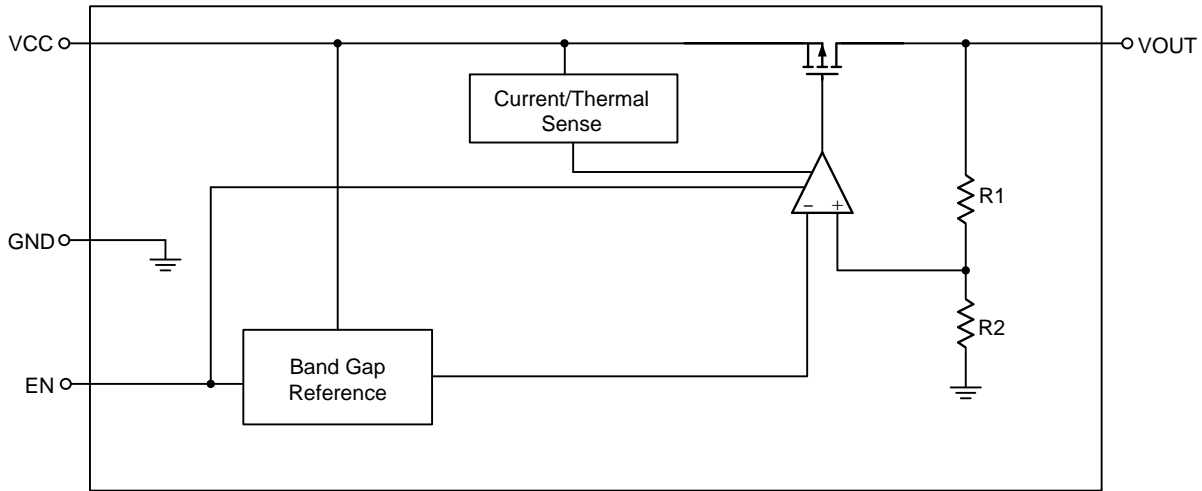

Operation

The RTQ2569 ultra low quiescent current regulator is ideally suited for automotive and other battery operated systems, with less than 2µA quiescent current at a 10mA load. The device features low dropout voltage and low current in the standby mode and retains all of the features that are common to low dropout regulators including a low dropout P-MOSFET, over current protect circuit protection and thermal shutdown. The RTQ2569 has a 36V maximum operating voltage limit and ±2% output voltage tolerance over temperature range.

Output Transistor

The RTQ2569 builds in a P-MOSFET output transistor which provides a low switch-on resistance for low dropout voltage applications.

Error Amplifier

The Error Amplifier compares the internal reference voltage with the output feedback voltage from the internal divider, and controls the Gate voltage of P-MOSFET to support good line regulation and load regulation at output voltage.

Enable

The RTQ2569 provides an EN pin, as an external chip enable control, to enable or disable the device. If V_{EN} is held below a logic-low threshold voltage (V_{IL}) of the enable input (EN), the converter will enter into shutdown mode, that is, the converter is disabled.

Current Limit Protection

Over-current protection of the RTQ2569 prevents IC damaged and reduces the thermal effects by overload conditions. When an overload or short circuit is happen, the device will shut down to prevent IC damaged. IC recovery when overload or short circuit is removed.

Over-Temperature Protection

The RTQ2569 includes an over-temperature protection (OTP) circuitry to prevent overheating due to excessive power dissipation. The OTP will shut down operation when junction temperature exceeds a thermal shutdown threshold 150°C (typ.). Once the junction temperature cools down by a thermal shutdown hysteresis 20°C, the IC will resume normal operation with a complete soft-start.

Absolute Maximum Ratings (Note 1)

- VCC, EN to GND ----- -0.3V to 40V
- VOUT to VCC ----- -40V to 0.3V
- VOUT to GND
 - RTQ2569-90/RTQ2569-C0 ----- -0.3V to 15V
 - RTQ2569-25/RTQ2569-30/RTQ2569-33/RTQ2569-50 ----- -0.3V to 6V
- Power Dissipation, P_D @ T_A = 25°C
 - WDFN-8L 3x3 ----- 1.38W
- Package Thermal Resistance (Note 2)
 - WDFN-8L 3x3, θ_{JA} ----- 72.5°C/W
 - WDFN-8L 3x3, θ_{JC} ----- 23.04°C/W
- Lead Temperature (Soldering, 10 sec.) ----- 260°C
- Junction Temperature ----- 150°C
- Storage Temperature Range ----- -65°C to 150°C
- ESD Susceptibility (Note 3)
 - HBM (Human Body Model) ----- 2kV

Recommended Operating Conditions (Note 4)

- Supply Input Voltage ----- 3.5V to 36V
- Junction Temperature Range ----- -40°C to 125°C
- Ambient Temperature Range ----- -40°C to 125°C

Electrical Characteristics

(C_{IN} = 1μF, T_J = -40°C to 125°C, unless otherwise specified)

Parameter	Symbol	Test Conditions	Min	Typ	Max	Unit
Supply Voltage	V _{CC}		3.5	--	36	V
Output Voltage Range	V _{OUT}		2.5	--	12	V
DC Output Accuracy	ΔV _{OUT}	V _{CC} = 15V, I _{LOAD} = 10mA	-2	--	+2	%
Dropout Voltage	V _{DROP}	V _{CC} = 3.5V, V _{OUT} < 3.5V, I _{LOAD} = 10mA V _{CC} = V _{OUT} , V _{OUT} ≥ 3.5V, I _{LOAD} = 10mA	--	0.2	0.36	V
V _{CC} Consumption Current	I _Q	V _{CC} = V _{EN} = 15V, V _{OUT} ≤ 5.5V, I _{LOAD} = 0mA	--	2	3.5	μA
		V _{CC} = V _{EN} = 15V, V _{OUT} > 5.5V, I _{LOAD} = 0mA	--	3.5	5	μA
Shutdown GND Current		V _{CC} = 36V, V _{EN} = 0V, V _{OUT} = 0V, -40°C ≤ T _J ≤ 105°C	--	0.01	0.2	μA
Shutdown GND Current		V _{CC} = 36V, V _{EN} = 0V, V _{OUT} = 0V, 105°C < T _J ≤ 125°C	--	0.2	0.4	μA
EN Input Current	I _{EN}	V _{EN} = 36V	--	0.01	0.1	μA

Parameter		Symbol	Test Conditions	Min	Typ	Max	Unit
Line Regulation		ΔV_{LINE}	$V_{OUT} + 1 < V_{CC} < 36V, V_{OUT} > 3.3V,$ $I_{LOAD} = 1mA$	--	0.04	0.5	%
			$V_{OUT} + 1 < V_{CC} < 36V, V_{OUT} \leq 3.3V,$ $I_{LOAD} = 1mA$	--	0.04	0.6	
Load Regulation		ΔV_{LOAD}	$V_{CC} = V_{OUT} + 4V, 0mA < I_{LOAD} < 100mA,$ $-40^{\circ}C \leq T_J \leq 105^{\circ}C$	--	--	1	%
Load Regulation		ΔV_{LOAD}	$V_{CC} = V_{OUT} + 4V, 0mA < I_{LOAD} < 100mA,$ $105^{\circ}C < T_J \leq 125^{\circ}C$	--	--	1.5	%
Output Current Limit		I_{LIM}	$V_{CC} = V_{OUT} + 6V, V_{OUT} < 5.5V$ $V_{CC} = V_{OUT} + 3V, V_{OUT} \geq 5.5V$	200	275	350	mA
Enable Input Voltage	Logic-High	V_{IH}		1.7	--	--	V
	Logic-Low	V_{IL}		--	--	0.5	
Thermal Shutdown Temperature		T_{SD}	$I_{LOAD} = 30mA,$ (Note 5)	--	150	--	$^{\circ}C$
Thermal Shutdown Hysteresis		ΔT_{SD}	Note 5	--	20	--	$^{\circ}C$

Note 1. Stresses beyond those listed under “Absolute Maximum Ratings” may cause permanent damage to the device. These are stress ratings only, and functional operation of the device at these or any other conditions beyond those indicated in the operational sections of the specifications is not implied. Exposure to absolute maximum rating conditions may affect device reliability.

Note 2. θ_{JA} is measured under natural convection (still air) at $T_A = 25^{\circ}C$ on a high effective-thermal-conductivity two-layer test board in size of 70mm x 50mm with 1oz copper thickness. θ_{JC} is measured at the exposed pad of the package.

Note 3. Devices are ESD sensitive. Handling precaution is recommended.

Note 4. The device is not guaranteed to function outside its operating conditions.

Note 5. Guarantee by design.

Typical Application Circuit

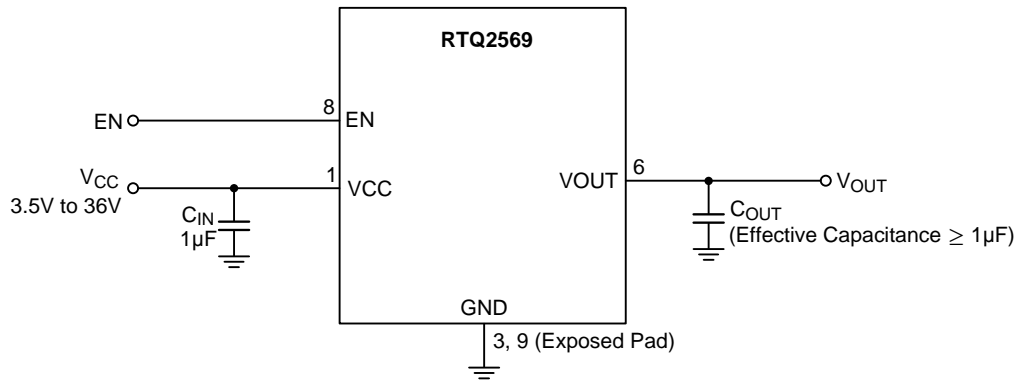

Required for stability. C_{OUT} must be at least $1\mu F$ for the RTQ2569 capacitance must be maintained over entire expected operating temperature range, and located as close as possible to the regulator.

Note : All input and output capacitance in the suggested parameter mean the effective capacitance. The effective capacitance needs to consider any De-rating Effect like DC bias.

Typical Operating Characteristics

($V_{CC} = 14V$, $C_{IN} = 1\mu F$, $C_{OUT} = 1\mu F$, $V_{EN} = V_{CC}$, $T_A = 25^\circ C$, unless otherwise noted.)

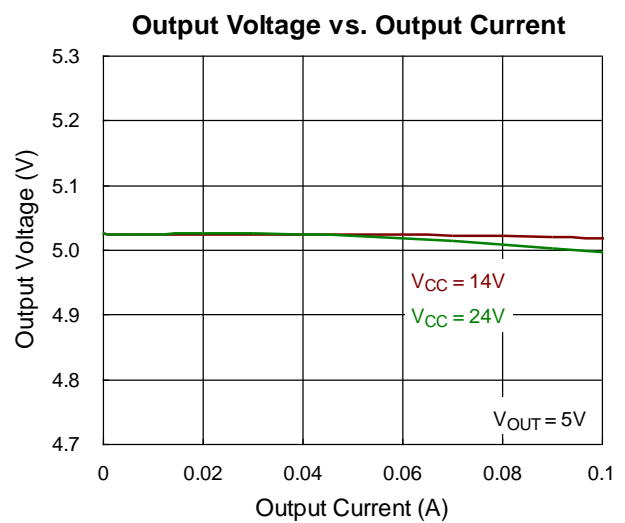
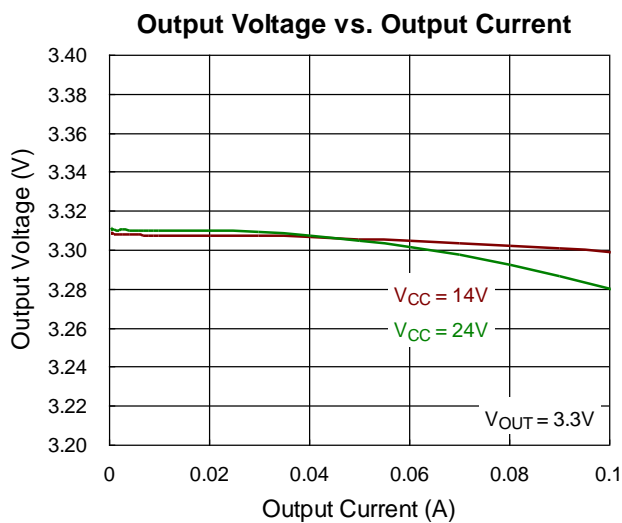
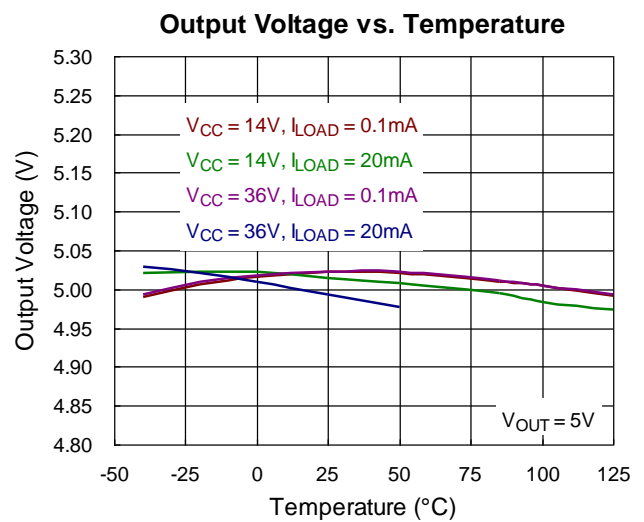
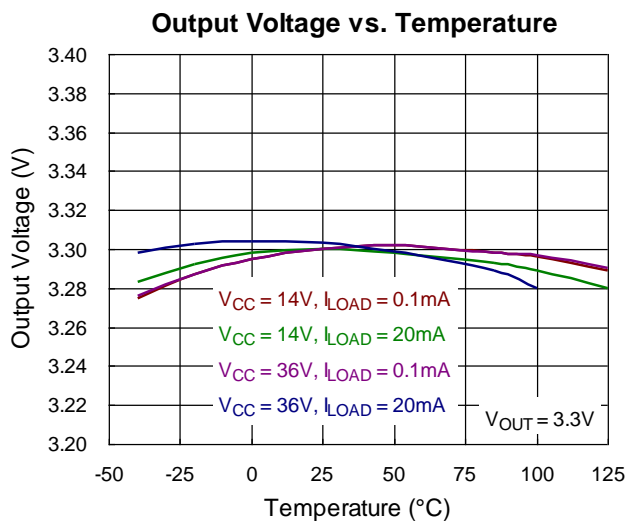
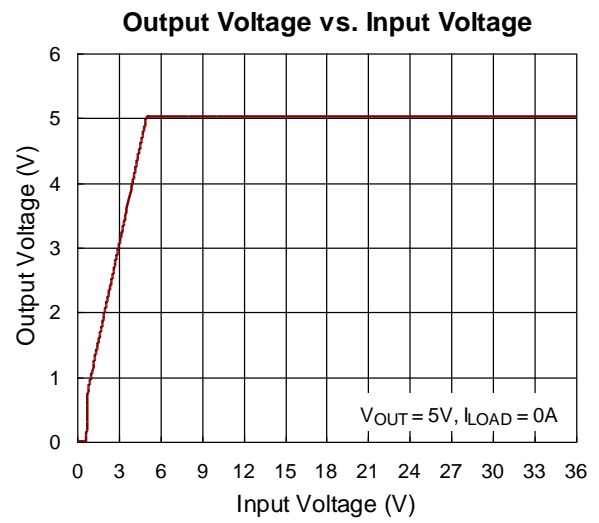
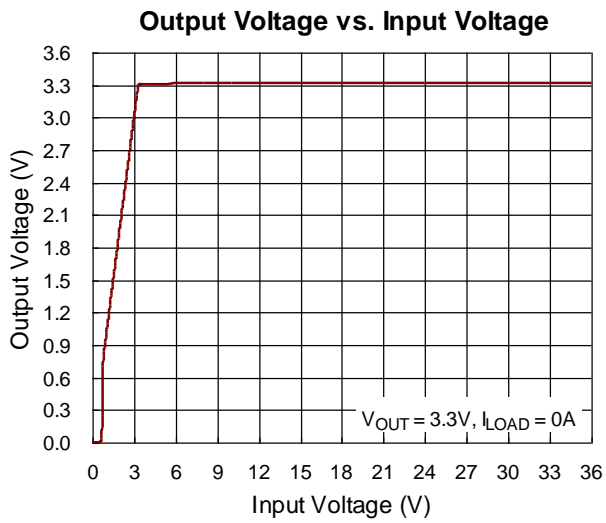

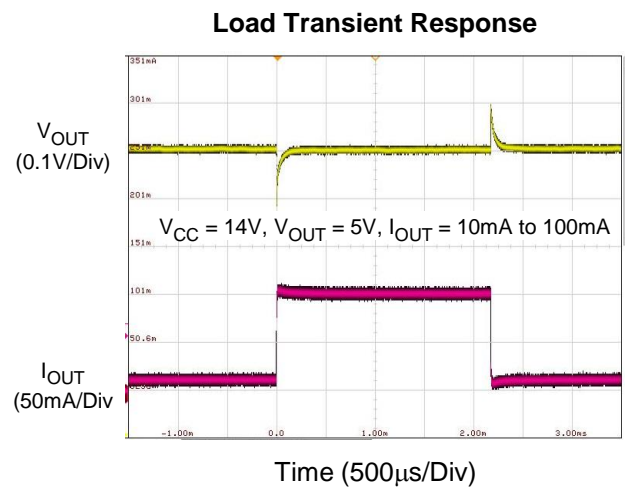
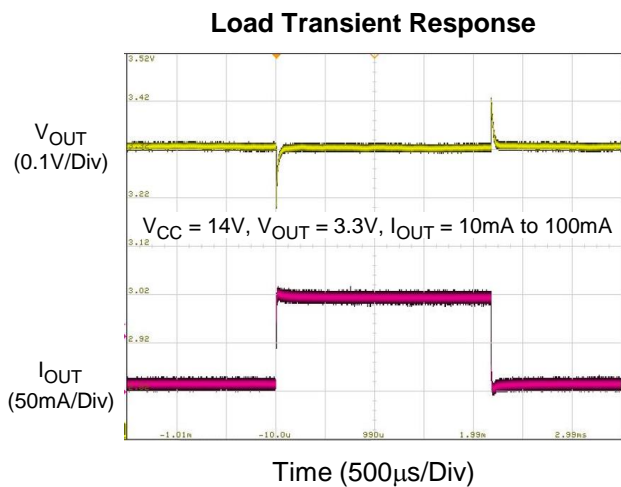
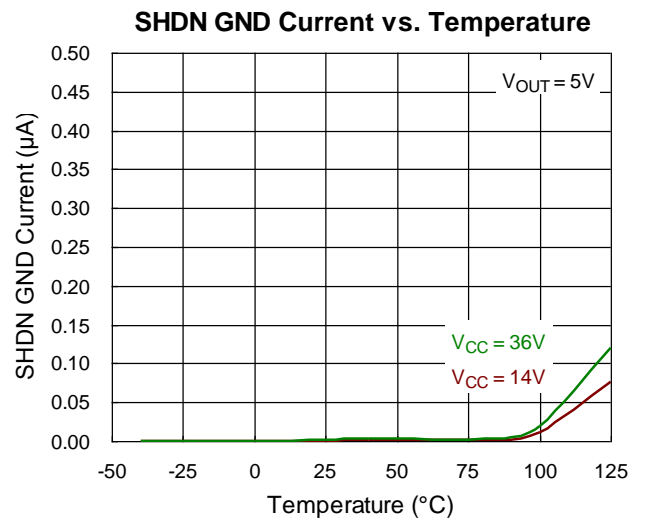
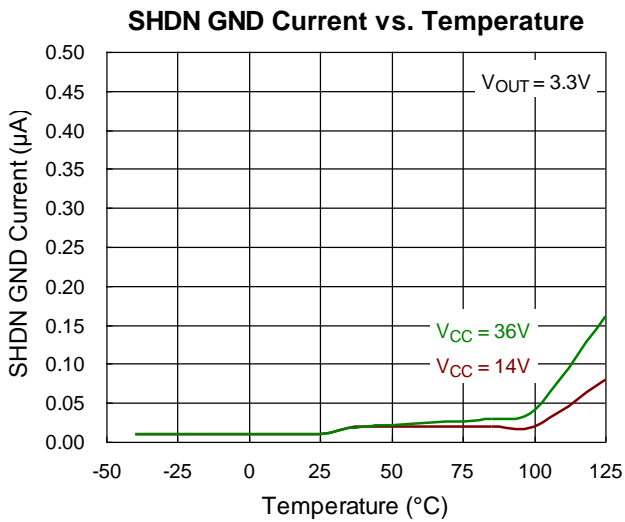
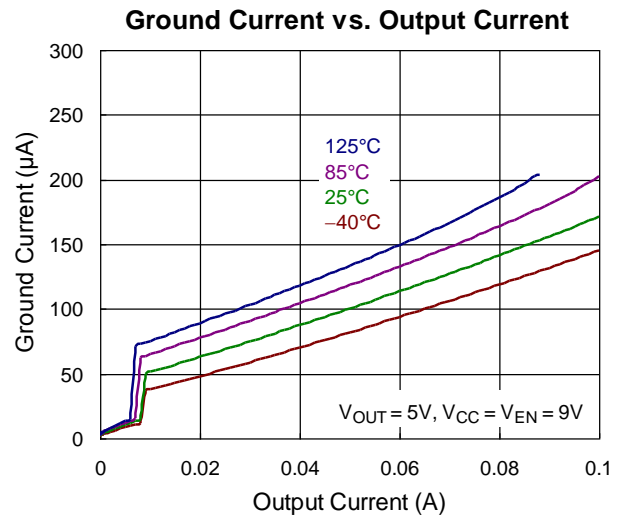
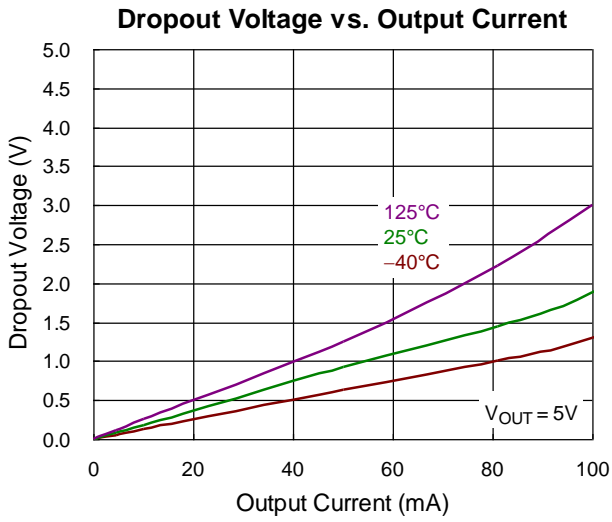

Line Transient Response

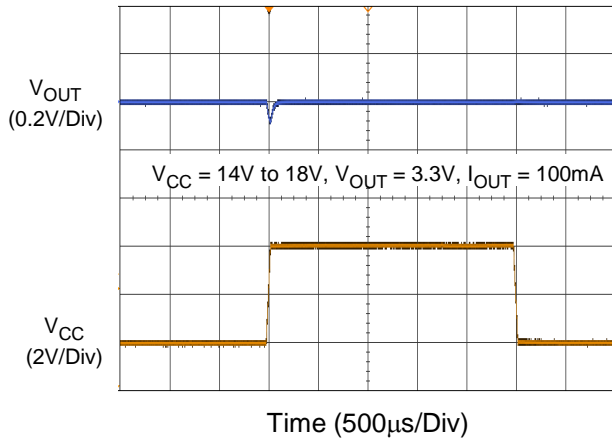

Line Transient Response

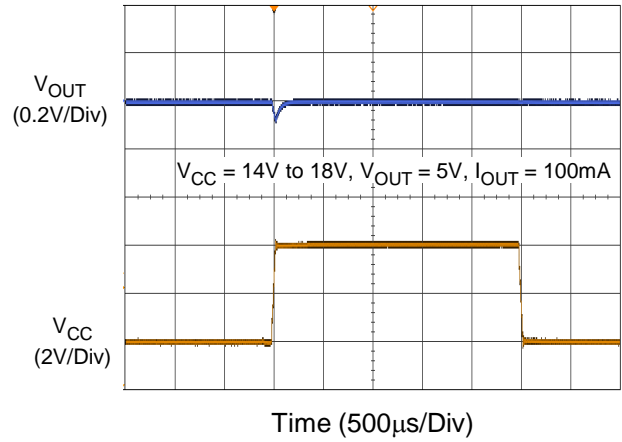

Power On from EN

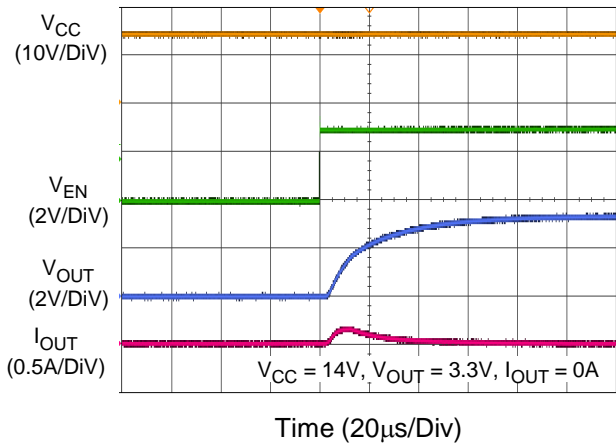

Power On from EN

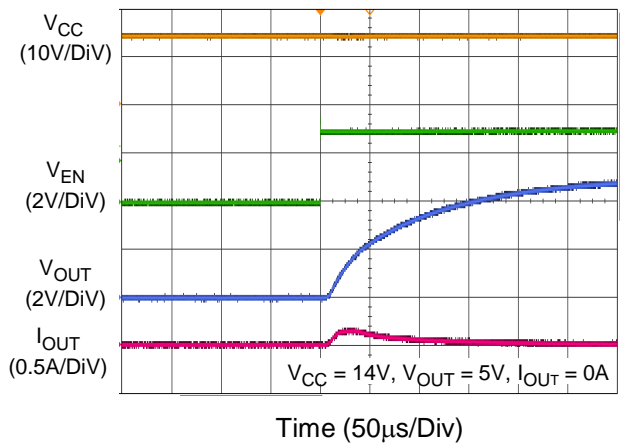

Power On from EN

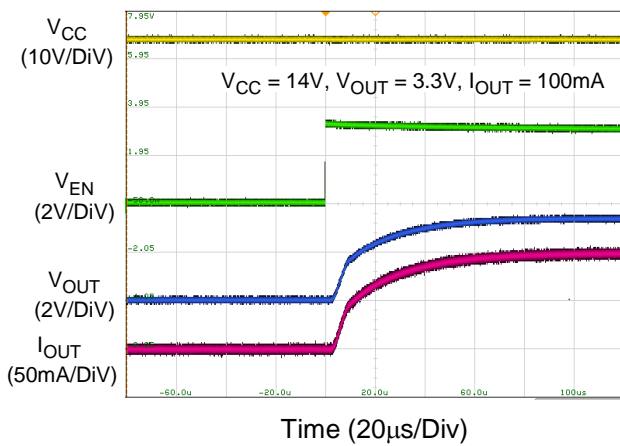

Power On from EN

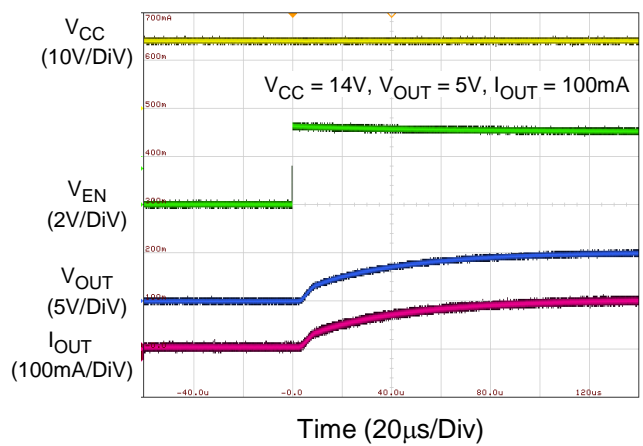

Power On from VCC

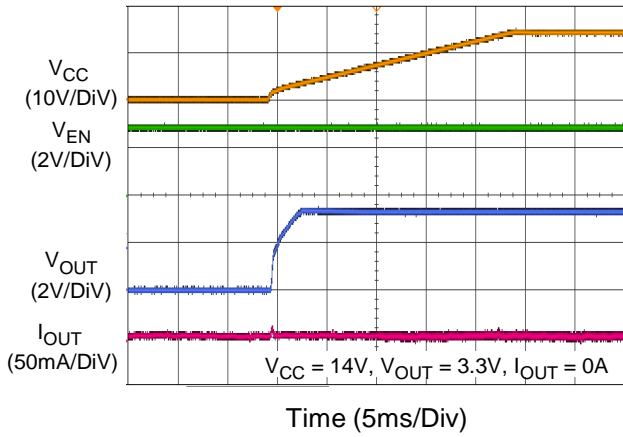

Power On from VCC

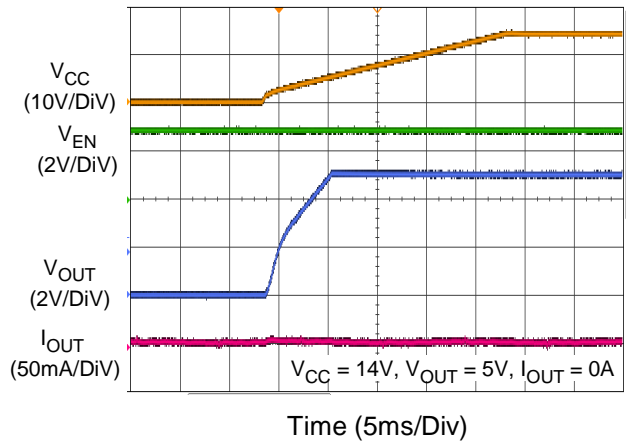

Power On from VCC

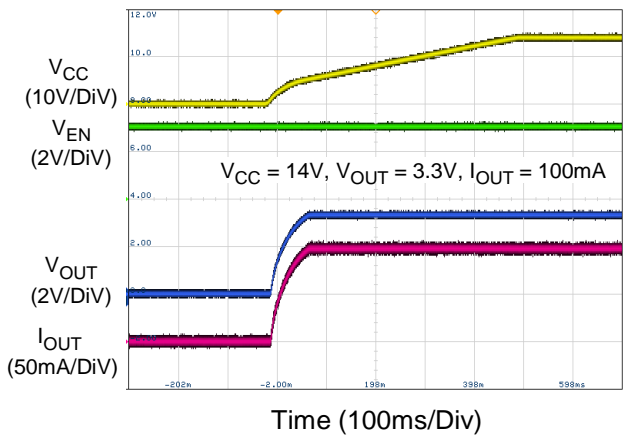

Power On from VCC

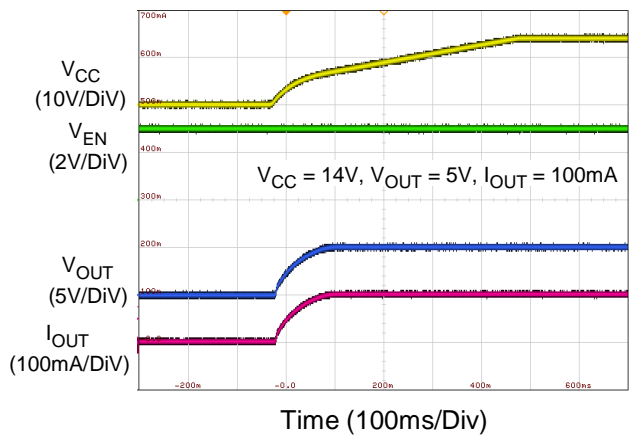

PSRR vs. Frequency

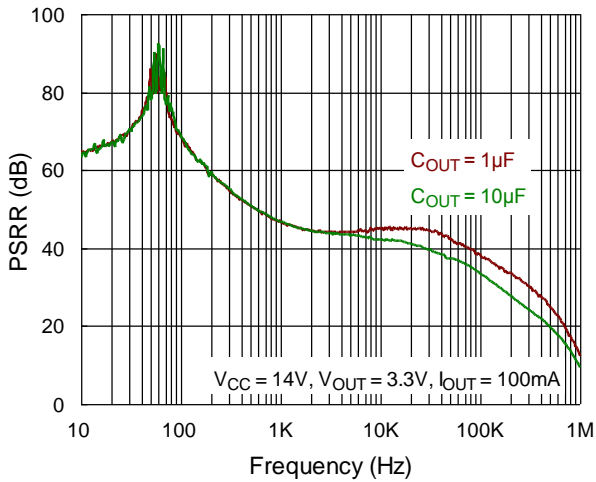

PSRR vs. Frequency

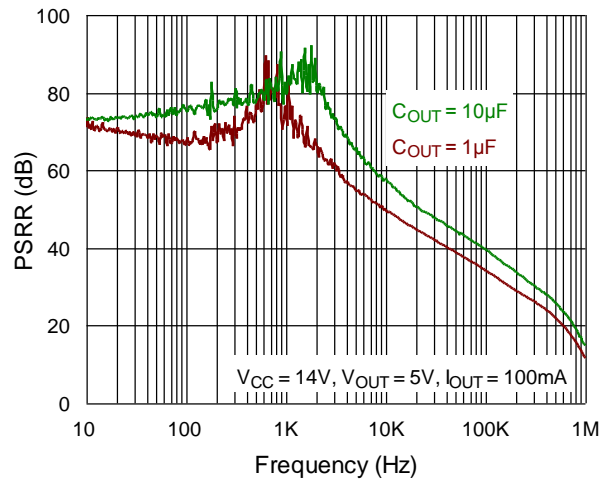

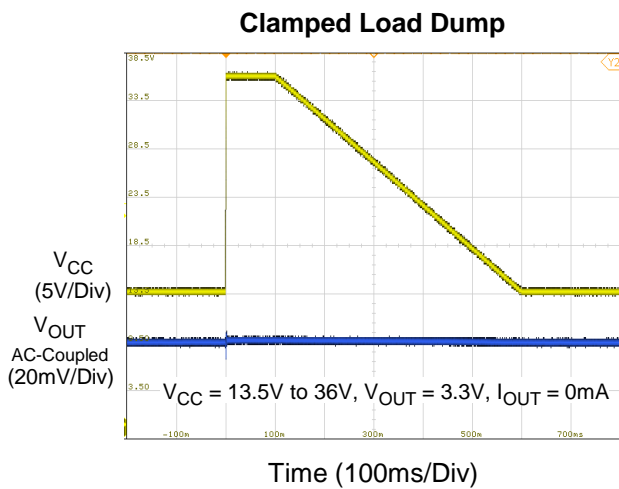
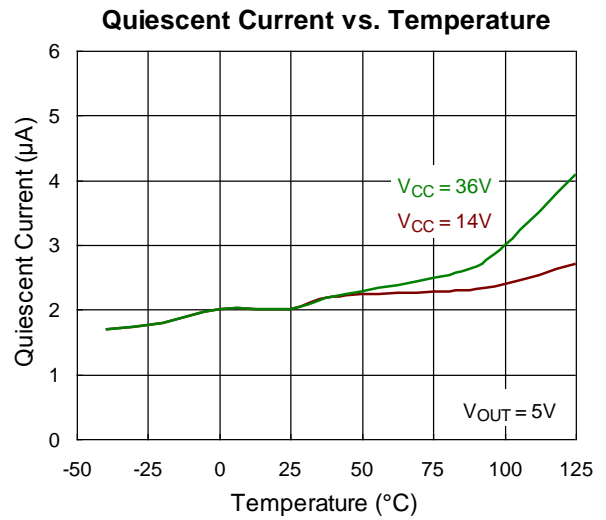
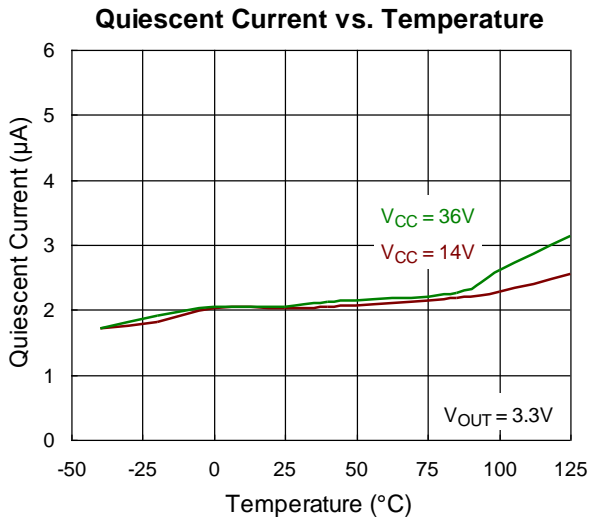
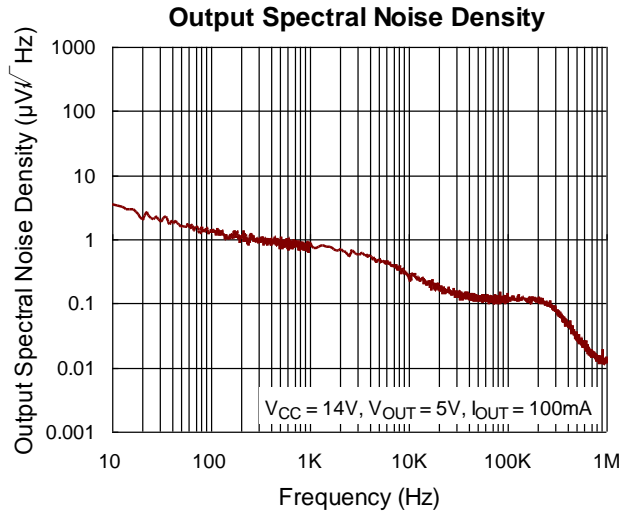
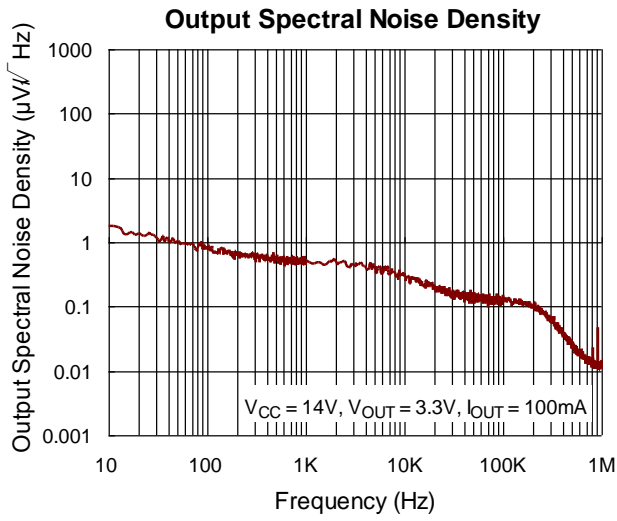

Application Information

The RTQ2569 is a low quiescent current, low dropout voltage linear regulator. The RTQ2569 has a 36V maximum operating voltage limit, a -40°C to 125°C operating temperature range, and $\pm 2\%$ output voltage tolerance over temperature range.

C_{IN} and C_{OUT} Selection

The RTQ2569 devices are stable with output capacitors with an effective capacitance of $1\mu\text{F}$. The maximum capacitance for stability is $66\mu\text{F}$.

The effective capacitance is the minimum capacitance value of a capacitor after taking into account variations resulting from tolerances, temperature, and dc bias effects. X5R and X7R type ceramic capacitors are recommended because these capacitors have minimal variation in value and ESR over temperature.

Although an input capacitor is not required for stability, good analog design practice is to connect a $1\mu\text{F}$ capacitor from VCC to GND. This capacitor counteracts reactive input sources and improves transient response, input ripple, and PSRR.

Dropout Voltage

The dropout voltage refers to the voltage difference between the VCC and VOUT pins while operating at specific output current. The dropout voltage V_{DROP} also can be expressed as the voltage drop on the pass-FET at specific output current (I_{RATED}) while the pass-FET is fully operating at ohmic region and the pass-FET can be characterized as an resistance $R_{\text{DS(ON)}}$. Thus the dropout voltage can be defined as ($V_{\text{DROP}} = V_{\text{CC}} - V_{\text{OUT}} = R_{\text{DS(ON)}} \times I_{\text{RATED}}$).

For normal operation, the suggested LDO operating range is ($V_{\text{CC}} > V_{\text{OUT}} + V_{\text{DROP}}$) for good transient response and PSRR ability.

Chip Enable Operation

The EN pin is the chip enable input for normal operation condition VCC (3.5V to 36V). Pull the EN pin low ($<0.5\text{V}$) will shut down the device. Drive the EN pin to high ($>1.7\text{V}$, $<36\text{V}$) will turn on the device again. For automatic start-up, the EN pin, with high-voltage rating,

can be connect to the input supply VCC directly. For external timing control (e.g. RC), the EN pin can also be externally pull to High by adding a $100\text{k}\Omega$ or greater resistor between the EN pin and the VCC pin.

For power sequence condition, the VCC should be power on first. Because the device does not feature UVLO input function, the EN pin threshold will be different when VCC input voltage is below 2.5V. For example, if provide the EN voltage of 1V and then provide the VCC voltage of 1V (EN threshold voltage is 0.42V at VCC of 1V), the output voltage will be close to VCC voltage (1V). Please refer to the enable threshold voltage vs input voltage in Figure 1.

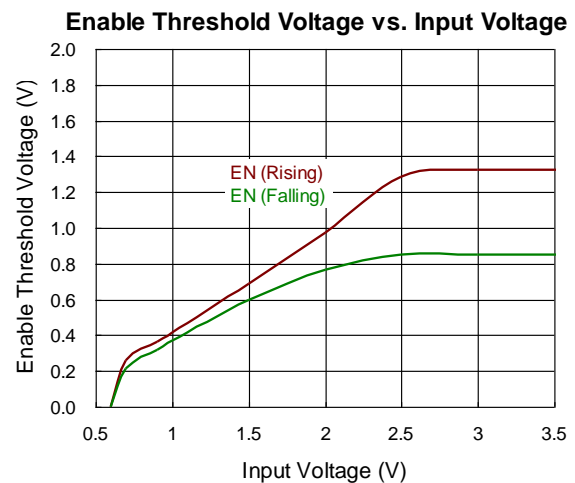

Figure 1.

Current Limit

The RTQ2569 continuously monitors the output current to protect the pass transistor against abnormal operations. When an overload or short circuit is encountered, the current limit circuitry controls the pass transistor's gate voltage to limit the output within the predefined range. By reason of the build-in body diode, the pass transistor conducts current when the output voltage exceeds input voltage.

Thermal Considerations

The junction temperature should never exceed the absolute maximum junction temperature $T_{\text{J(MAX)}}$, listed under Absolute Maximum Ratings, to avoid permanent damage to the device. The maximum allowable power

dissipation depends on the thermal resistance of the IC package, the PCB layout, the rate of surrounding airflow, and the difference between the junction and ambient temperatures. The maximum power dissipation can be calculated using the following formula :

$$P_{D(MAX)} = (T_{J(MAX)} - T_A) / \theta_{JA}$$

where $T_{J(MAX)}$ is the maximum junction temperature, T_A is the ambient temperature, and θ_{JA} is the junction-to-ambient thermal resistance.

For continuous operation, the maximum operating junction temperature indicated under Recommended Operating Conditions is 125°C. The junction-to-ambient thermal resistance, θ_{JA} , is highly package dependent. For a WDFN-8L 3x3 package, the thermal resistance, θ_{JA} is 72.5°C/W on a high effective-thermal-conductivity two-layer test board in size of 70mm x 50mm with 1oz copper thickness. The maximum power dissipation at $T_A = 25^\circ\text{C}$ can be calculated as below :

$$P_{D(MAX)} = (125^\circ\text{C} - 25^\circ\text{C}) / (72.5^\circ\text{C/W}) = 1.38\text{W for a WDFN-8L 3x3 package.}$$

The maximum power dissipation depends on the operating ambient temperature for fixed $T_{J(MAX)}$ and thermal resistance, θ_{JA} . The derating curve in Figure 2 allows the designer to see the effect of rising ambient temperature on the maximum power dissipation.

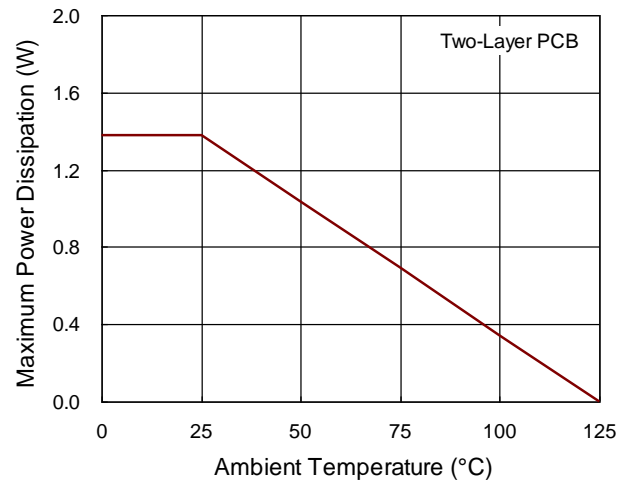

Figure 2. Derating Curve of Maximum Power Dissipation

Layout Consideration

The dynamic performance of the RTQ2569 is dependent on the layout of the PCB. Best performance is achieved by placing C_{IN} and C_{OUT} on the same side of the PCB as the RTQ2569, and as close to the packages is practical. The ground connections for C_{IN} and C_{OUT} must be back to the RTQ2569 ground pin using as wide and as short of a copper trace as possible.

Connections using long trace lengths, narrow trace widths, and/or connections through vias must be avoided as these add parasitic inductances and resistances that give inferior performance, especially during transient conditions.

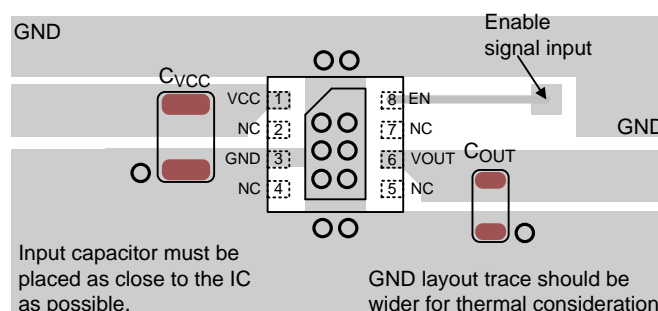
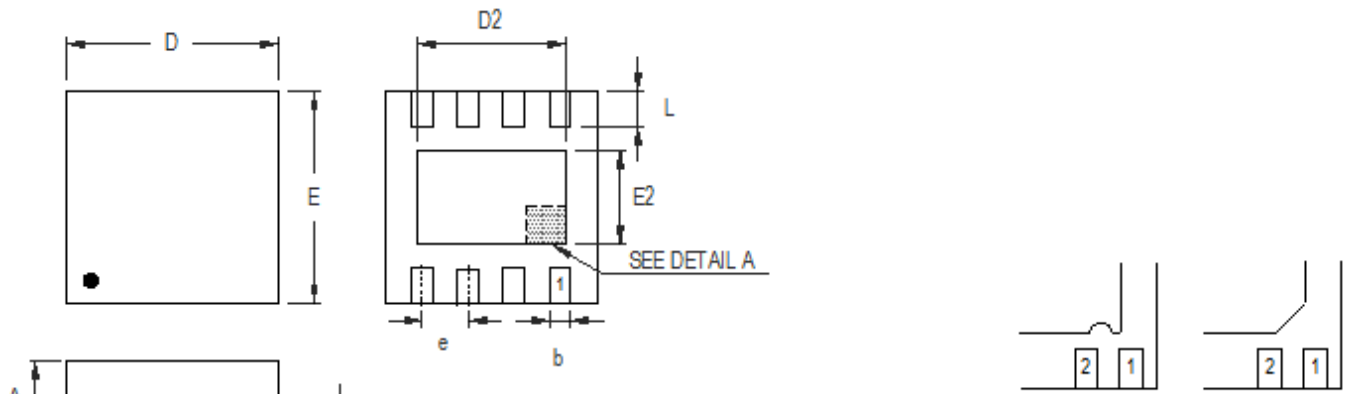

Figure 2. PCB Layout Guide

Outline Dimension



DETAIL A

Pin #1 ID and Tie Bar Mark Options

Note : The configuration of the Pin #1 identifier is optional, but must be located within the zone indicated.

Symbol	Dimensions In Millimeters		Dimensions In Inches	
	Min	Max	Min	Max
A	0.700	0.800	0.028	0.031
A1	0.000	0.050	0.000	0.002
A3	0.175	0.250	0.007	0.010
b	0.200	0.300	0.008	0.012
D	2.950	3.050	0.116	0.120
D2	2.100	2.350	0.083	0.093
E	2.950	3.050	0.116	0.120
E2	1.350	1.600	0.053	0.063
e	0.650		0.026	
L	0.425	0.525	0.017	0.021

W-Type 8L DFN 3x3 Package

Footprint Information

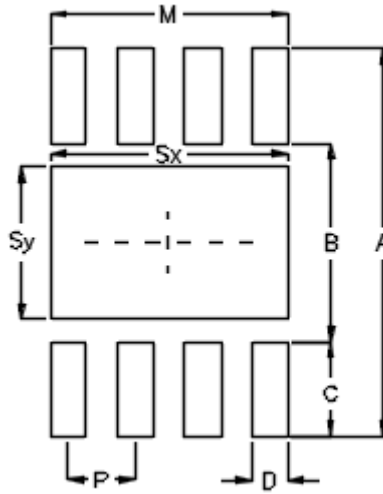

Package	Number of Pin	Footprint Dimension (mm)								Tolerance
		P	A	B	C	D	Sx	Sy	M	
V/W/U/XDFN3*3-8	8	0.65	3.80	1.94	0.93	0.35	2.30	1.50	2.30	±0.05

Richtek Technology Corporation

14F, No. 8, Tai Yuen 1st Street, Chupei City

Hsinchu, Taiwan, R.O.C.

Tel: (8863)5526789



RICHTEK

Richtek products are sold by description only. Richtek reserves the right to change the circuitry and/or specifications without notice at any time. Customers should obtain the latest relevant information and data sheets before placing orders and should verify that such information is current and complete. Richtek cannot assume responsibility for use of any circuitry other than circuitry entirely embodied in a Richtek product. Information furnished by Richtek is believed to be accurate and reliable. However, no responsibility is assumed by Richtek or its subsidiaries for its use; nor for any infringements of patents or other rights of third parties which may result from its use. No license is granted by implication or otherwise under any patent or patent rights of Richtek or its subsidiaries.



Copyright © 2020 Richtek Technology Corporation. All rights reserved. **RICHTEK** is a registered trademark of Richtek Technology Corporation.

Looking for pricing, stock, or lifecycle information?

Click below to explore more details on WIN SOURCE:

-  [View RTQ2569-33GQW-QA on WIN SOURCE](#)
-  [Richtek USA Inc. Information](#)

Optimize Your Supply Chain with WIN SOURCE Solutions

-  Global Sourcing Solution
-  Obsolete Management
-  Cost Control Management
-  Shortage Management
-  Alternative Solution
-  Excess Inventory Management