



**THE DATASHEET OF  
74HCT04BQ,115**





# 74HC04; 74HCT04

Hex inverter

Rev. 10 — 16 February 2024

Product data sheet

## 1. General description

The 74HC04; 74HCT04 is a hex inverter. The inputs include clamp diodes that enable the use of current limiting resistors to interface inputs to voltages in excess of  $V_{CC}$ .

## 2. Features and benefits

- Wide supply voltage range from 2.0 V to 6.0 V
- CMOS low power dissipation
- High noise immunity
- Latch-up performance exceeds 100 mA per JESD 78 Class II Level B
- Complies with JEDEC standards:
  - JESD8C (2.7 V to 3.6 V)
  - JESD7A (2.0 V to 6.0 V)
- Input levels:
  - For 74HC04: CMOS level
  - For 74HCT04: TTL level
- ESD protection:
  - HBM: ANSI/ESDA/JEDEC JS-001 class 2 exceeds 2000 V
  - CDM: ANSI/ESDA/JEDEC JS-002 class C3 exceeds 1000 V
- Multiple package options
- Specified from -40 °C to +85 °C and from -40 °C to +125 °C

## 3. Ordering information

Table 1. Ordering information

Type number	Package			
	Temperature range	Name	Description	Version
<a href="#">74HC04D</a> <a href="#">74HCT04D</a>	-40 °C to +125 °C	SO14	plastic small outline package; 14 leads; body width 3.9 mm	<a href="#">SOT108-1</a>
<a href="#">74HC04PW</a> <a href="#">74HCT04PW</a>	-40 °C to +125 °C	TSSOP14	plastic thin shrink small outline package; 14 leads; body width 4.4 mm	<a href="#">SOT402-1</a>
<a href="#">74HC04BQ</a> <a href="#">74HCT04BQ</a>	-40 °C to +125 °C	DHVQFN14	plastic dual in-line compatible thermal enhanced very thin quad flat package; no leads; 14 terminals; body 2.5 × 3 × 0.85 mm	<a href="#">SOT762-1</a>
<a href="#">74HC04BZ</a> <a href="#">74HCT04BZ</a>	-40 °C to +125 °C	DHXQFN14	plastic, leadless dual in-line compatible thermal enhanced extreme thin quad flat package; no leads; 14 terminals; 0.4 mm pitch; body 2 mm × 2 mm × 0.48 mm	<a href="#">SOT8014-1</a>

### 4. Functional diagram

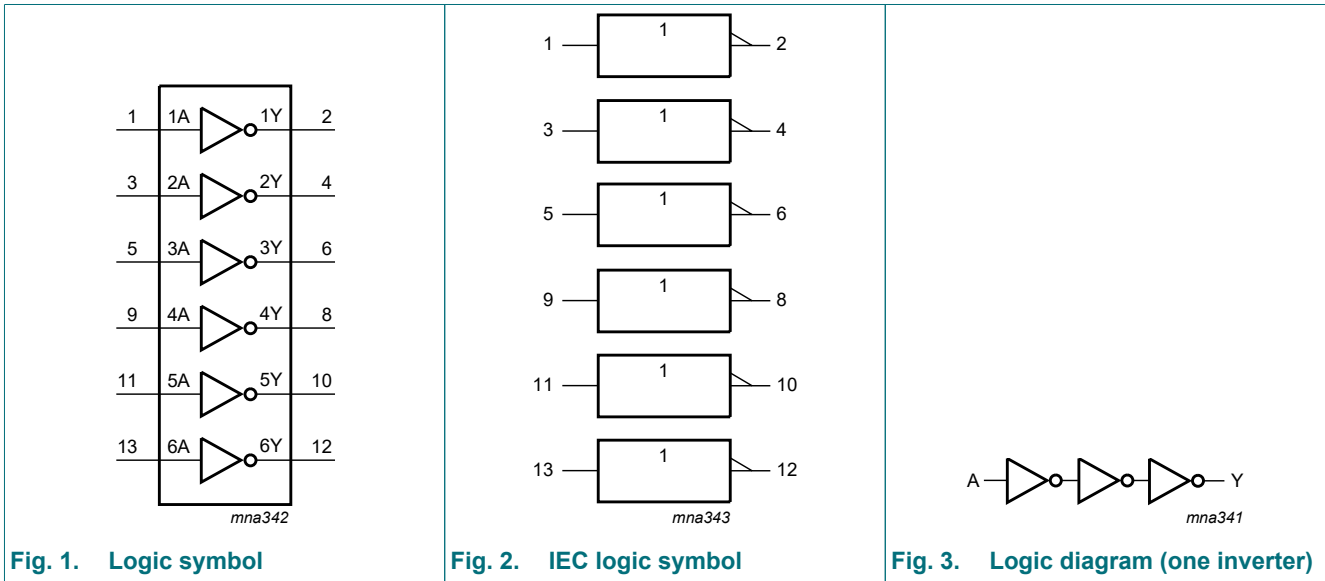

## 5. Pinning information

### 5.1. Pinning

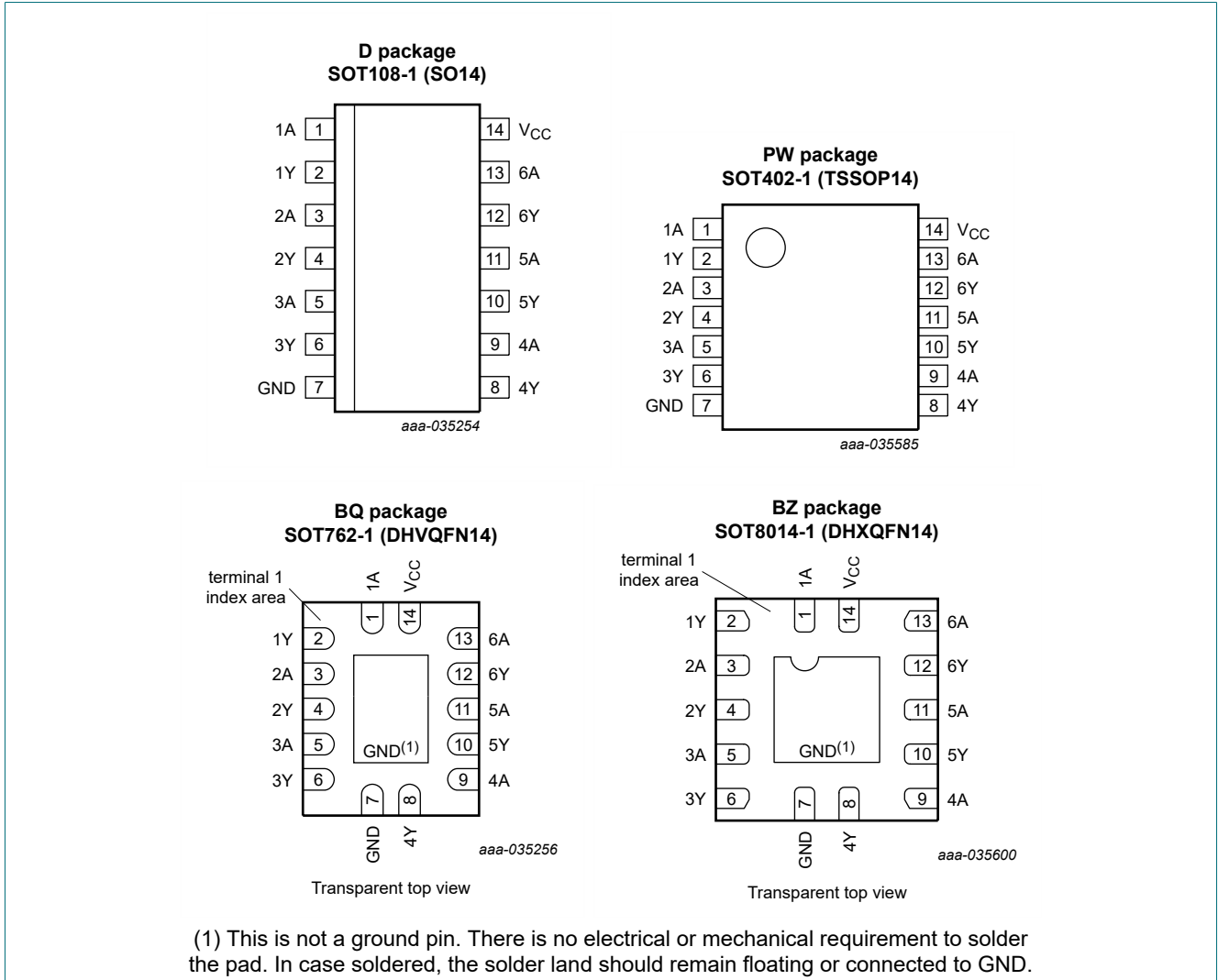

### 5.2. Pin description

Table 2. Pin description

Symbol	Pin	Description
1A, 2A, 3A, 4A, 5A, 6A	1, 3, 5, 9, 11, 13	data input
1Y, 2Y, 3Y, 4Y, 5Y, 6Y	2, 4, 6, 8, 10, 12	data output
GND	7	ground (0 V)
V <sub>CC</sub>	14	supply voltage

## 6. Functional description

**Table 3. Function table**

*H = HIGH voltage level; L = LOW voltage level*

Input	Output
nA	nY
L	H
H	L

## 7. Limiting values

**Table 4. Limiting values**

*In accordance with the Absolute Maximum Rating System (IEC 60134). Voltages are referenced to GND (ground = 0 V).*

Symbol	Parameter	Conditions	Min	Max	Unit
$V_{CC}$	supply voltage		-0.5	+7	V
$I_{IK}$	input clamping current	$V_I < -0.5\text{ V}$ or $V_I > V_{CC} + 0.5\text{ V}$ [1]	-	$\pm 20$	mA
$I_{OK}$	output clamping current	$V_O < -0.5\text{ V}$ or $V_O > V_{CC} + 0.5\text{ V}$ [1]	-	$\pm 20$	mA
$I_O$	output current	$-0.5\text{ V} < V_O < V_{CC} + 0.5\text{ V}$	-	$\pm 25$	mA
$I_{CC}$	supply current		-	50	mA
$I_{GND}$	ground current		-50	-	mA
$T_{stg}$	storage temperature		-65	+150	°C
$P_{tot}$	total power dissipation	SOT108-1 SOT402-1 SOT762-1 [2]	-	500	mW
		SOT8014-1	-	250	mW

[1] The input and output voltage ratings may be exceeded if the input and output current ratings are observed.

[2] For SOT108-1 (SO14) package:  $P_{tot}$  derates linearly with 10.1 mW/K above 100 °C.  
 For SOT402-1 (TSSOP14) package:  $P_{tot}$  derates linearly with 7.3 mW/K above 81 °C.  
 For SOT762-1 (DHVQFN14) package:  $P_{tot}$  derates linearly with 9.6 mW/K above 98 °C.

## 8. Recommended operating conditions

**Table 5. Recommended operating conditions**

*Voltages are referenced to GND (ground = 0 V)*

Symbol	Parameter	Conditions	74HC04			74HCT04			Unit
			Min	Typ	Max	Min	Typ	Max	
$V_{CC}$	supply voltage		2.0	5.0	6.0	4.5	5.0	5.5	V
$V_I$	input voltage		0	-	$V_{CC}$	0	-	$V_{CC}$	V
$V_O$	output voltage		0	-	$V_{CC}$	0	-	$V_{CC}$	V
$T_{amb}$	ambient temperature		-40	+25	+125	-40	+25	+125	°C
$\Delta t/\Delta V$	input transition rise and fall rate	$V_{CC} = 2.0\text{ V}$	-	-	625	-	-	-	ns/V
		$V_{CC} = 4.5\text{ V}$	-	1.67	139	-	1.67	139	ns/V
		$V_{CC} = 6.0\text{ V}$	-	-	83	-	-	-	ns/V

## 9. Static characteristics

**Table 6. Static characteristics**

At recommended operating conditions; voltages are referenced to GND (ground = 0 V).

Symbol	Parameter	Conditions	25 °C			-40 °C to +85 °C		-40 °C to +125 °C		Unit
			Min	Typ	Max	Min	Max	Min	Max	
<b>74HC04</b>										
V <sub>IH</sub>	HIGH-level input voltage	V <sub>CC</sub> = 2.0 V	1.5	1.2	-	1.5	-	1.5	-	V
		V <sub>CC</sub> = 4.5 V	3.15	2.4	-	3.15	-	3.15	-	V
		V <sub>CC</sub> = 6.0 V	4.2	3.2	-	4.2	-	4.2	-	V
V <sub>IL</sub>	LOW-level input voltage	V <sub>CC</sub> = 2.0 V	-	0.8	0.5	-	0.5	-	0.5	V
		V <sub>CC</sub> = 4.5 V	-	2.1	1.35	-	1.35	-	1.35	V
		V <sub>CC</sub> = 6.0 V	-	2.8	1.8	-	1.8	-	1.8	V
V <sub>OH</sub>	HIGH-level output voltage	V <sub>I</sub> = V <sub>IH</sub> or V <sub>IL</sub>								
		I <sub>O</sub> = -20 μA; V <sub>CC</sub> = 2.0 V	1.9	2.0	-	1.9	-	1.9	-	V
		I <sub>O</sub> = -20 μA; V <sub>CC</sub> = 4.5 V	4.4	4.5	-	4.4	-	4.4	-	V
		I <sub>O</sub> = -20 μA; V <sub>CC</sub> = 6.0 V	5.9	6.0	-	5.9	-	5.9	-	V
		I <sub>O</sub> = -4.0 mA; V <sub>CC</sub> = 4.5 V	3.98	4.32	-	3.84	-	3.7	-	V
I <sub>O</sub> = -5.2 mA; V <sub>CC</sub> = 6.0 V	5.48	5.81	-	5.34	-	5.2	-	V		
V <sub>OL</sub>	LOW-level output voltage	V <sub>I</sub> = V <sub>IH</sub> or V <sub>IL</sub>								
		I <sub>O</sub> = 20 μA; V <sub>CC</sub> = 2.0 V	-	0	0.1	-	0.1	-	0.1	V
		I <sub>O</sub> = 20 μA; V <sub>CC</sub> = 4.5 V	-	0	0.1	-	0.1	-	0.1	V
		I <sub>O</sub> = 20 μA; V <sub>CC</sub> = 6.0 V	-	0	0.1	-	0.1	-	0.1	V
		I <sub>O</sub> = 4.0 mA; V <sub>CC</sub> = 4.5 V	-	0.15	0.26	-	0.33	-	0.4	V
I <sub>O</sub> = 5.2 mA; V <sub>CC</sub> = 6.0 V	-	0.16	0.26	-	0.33	-	0.4	V		
I <sub>I</sub>	input leakage current	V <sub>I</sub> = V <sub>CC</sub> or GND; V <sub>CC</sub> = 6.0 V	-	-	±0.1	-	±1	-	±1	μA
I <sub>CC</sub>	supply current	V <sub>I</sub> = V <sub>CC</sub> or GND; I <sub>O</sub> = 0 A; V <sub>CC</sub> = 6.0 V	-	-	2	-	20	-	40	μA
C <sub>I</sub>	input capacitance		-	3.5	-	-	-	-	-	pF

Symbol	Parameter	Conditions	25 °C			-40 °C to +85 °C		-40 °C to +125 °C		Unit
			Min	Typ	Max	Min	Max	Min	Max	
<b>74HCT04</b>										
V <sub>IH</sub>	HIGH-level input voltage	V <sub>CC</sub> = 4.5 V to 5.5 V	2.0	1.6	-	2.0	-	2.0	-	V
V <sub>IL</sub>	LOW-level input voltage	V <sub>CC</sub> = 4.5 V to 5.5 V	-	1.2	0.8	-	0.8	-	0.8	V
V <sub>OH</sub>	HIGH-level output voltage	V <sub>I</sub> = V <sub>IH</sub> or V <sub>IL</sub> ; V <sub>CC</sub> = 4.5 V								
		I <sub>O</sub> = -20 µA	4.4	4.5	-	4.4	-	4.4	-	V
		I <sub>O</sub> = -4.0 mA	3.84	4.32	-	3.84	-	3.7	-	V
V <sub>OL</sub>	LOW-level output voltage	V <sub>I</sub> = V <sub>IH</sub> or V <sub>IL</sub> ; V <sub>CC</sub> = 4.5 V								
		I <sub>O</sub> = 20 µA	-	0	0.1	-	0.1	-	0.1	V
		I <sub>O</sub> = 5.2 mA	-	0.15	0.26	-	0.33	-	0.4	V
I <sub>I</sub>	input leakage current	V <sub>I</sub> = V <sub>CC</sub> or GND; V <sub>CC</sub> = 5.5 V	-	-	±0.1	-	±1	-	±1	µA
I <sub>CC</sub>	supply current	V <sub>I</sub> = V <sub>CC</sub> or GND; I <sub>O</sub> = 0 A; V <sub>CC</sub> = 5.5 V	-	-	2	-	20	-	40	µA
ΔI <sub>CC</sub>	additional supply current	per input pin; V <sub>I</sub> = V <sub>CC</sub> - 2.1 V; I <sub>O</sub> = 0 A; other inputs at V <sub>CC</sub> or GND; V <sub>CC</sub> = 4.5 V to 5.5 V	-	120	432	-	540	-	590	µA
C <sub>I</sub>	input capacitance		-	3.5	-	-	-	-	-	pF

## 10. Dynamic characteristics

**Table 7. Dynamic characteristics**

$GND = 0\text{ V}$ ;  $C_L = 50\text{ pF}$ ; for test circuit see [Fig. 5](#).

Symbol	Parameter	Conditions	25 °C			-40 °C to +85 °C	-40 °C to +125 °C	Unit
			Min	Typ	Max	Max	Max	
<b>74HC04</b>								
$t_{pd}$	propagation delay	nA to nY; see <a href="#">Fig. 4</a> [1]						
		$V_{CC} = 2.0\text{ V}$	-	25	85	105	130	ns
		$V_{CC} = 4.5\text{ V}$	-	9	17	21	26	ns
		$V_{CC} = 5.0\text{ V}$ ; $C_L = 15\text{ pF}$	-	7	-	-	-	ns
		$V_{CC} = 6.0\text{ V}$	-	7	14	18	22	ns
$t_t$	transition time	see <a href="#">Fig. 4</a> [2]						
		$V_{CC} = 2.0\text{ V}$	-	19	75	95	110	ns
		$V_{CC} = 4.5\text{ V}$	-	7	15	19	22	ns
		$V_{CC} = 6.0\text{ V}$	-	6	13	16	19	ns
$C_{PD}$	power dissipation capacitance	per package; $V_I = GND$ to $V_{CC}$ [3]	-	21	-	-	-	pF
<b>74HCT04</b>								
$t_{pd}$	propagation delay	nA to nY; see <a href="#">Fig. 4</a> [1]						
		$V_{CC} = 4.5\text{ V}$	-	10	19	24	29	ns
		$V_{CC} = 5.0\text{ V}$ ; $C_L = 15\text{ pF}$	-	8	-	-	-	ns
$t_t$	transition time	$V_{CC} = 4.5\text{ V}$ ; see <a href="#">Fig. 4</a> [2]	-	7	15	19	22	ns
$C_{PD}$	power dissipation capacitance	per package; $V_I = GND$ to $V_{CC} - 1.5\text{ V}$ [3]	-	24	-	-	-	pF

[1]  $t_{pd}$  is the same as  $t_{PHL}$  and  $t_{PLH}$ .

[2]  $t_t$  is the same as  $t_{THL}$  and  $t_{TLH}$ .

[3]  $C_{PD}$  is used to determine the dynamic power dissipation ( $P_D$  in  $\mu\text{W}$ ):

$$P_D = C_{PD} \times V_{CC}^2 \times f_i \times N + \sum(C_L \times V_{CC}^2 \times f_o) \text{ where:}$$

$f_i$  = input frequency in MHz;

$f_o$  = output frequency in MHz;

$C_L$  = output load capacitance in pF;

$V_{CC}$  = supply voltage in V;

$N$  = number of inputs switching;

$\sum(C_L \times V_{CC}^2 \times f_o)$  = sum of outputs.

10.1. Waveforms and test circuit

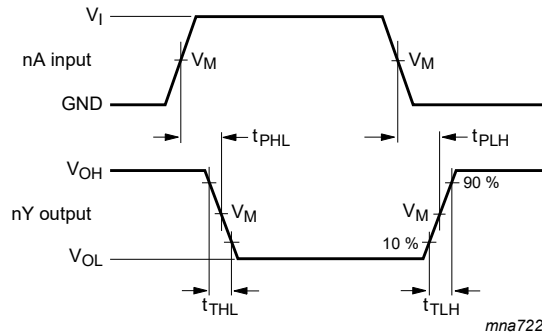

Measurement points are given in [Table 8](#).

$V_{OL}$  and  $V_{OH}$  are typical voltage output levels that occur with the output load.

Fig. 4. The input (nA) to output (nY) propagation delay times

Table 8. Measurement points

Type	Input	Output
	$V_M$	$V_M$
74HC04	$0.5 \times V_{CC}$	$0.5 \times V_{CC}$
74HCT04	1.3 V	1.3 V

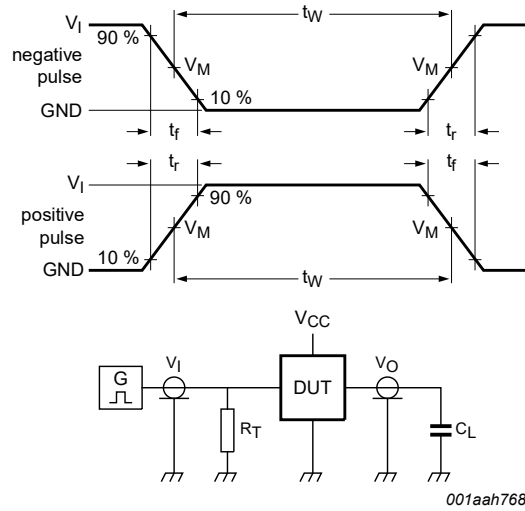

Test data is given in [Table 9](#).

Definitions test circuit:

$R_T$  = termination resistance should be equal to output impedance  $Z_o$  of the pulse generator;

$C_L$  = load capacitance including jig and probe capacitance.

Fig. 5. Test circuit for measuring switching times

Table 9. Test data

Type	Input		Load	Test
	$V_I$	$t_r, t_f$	$C_L$	
74HC04	$V_{CC}$	6.0 ns	15 pF, 50 pF	$t_{PLH}, t_{PHL}$
74HCT04	3.0 V	6.0 ns	15 pF, 50 pF	$t_{PLH}, t_{PHL}$

11. Package outline

SO14: plastic small outline package; 14 leads; body width 3.9 mm

SOT108-1



Fig. 6. Package outline SOT108-1 (SO14)

TSSOP14: plastic thin shrink small outline package; 14 leads; body width 4.4 mm

SOT402-1



Fig. 7. Package outline SOT402-1 (TSSOP14)

DHVQFN14: plastic dual in-line compatible thermal enhanced very thin quad flat package; no leads; 14 terminals; body 2.5 x 3 x 0.85 mm

SOT762-1

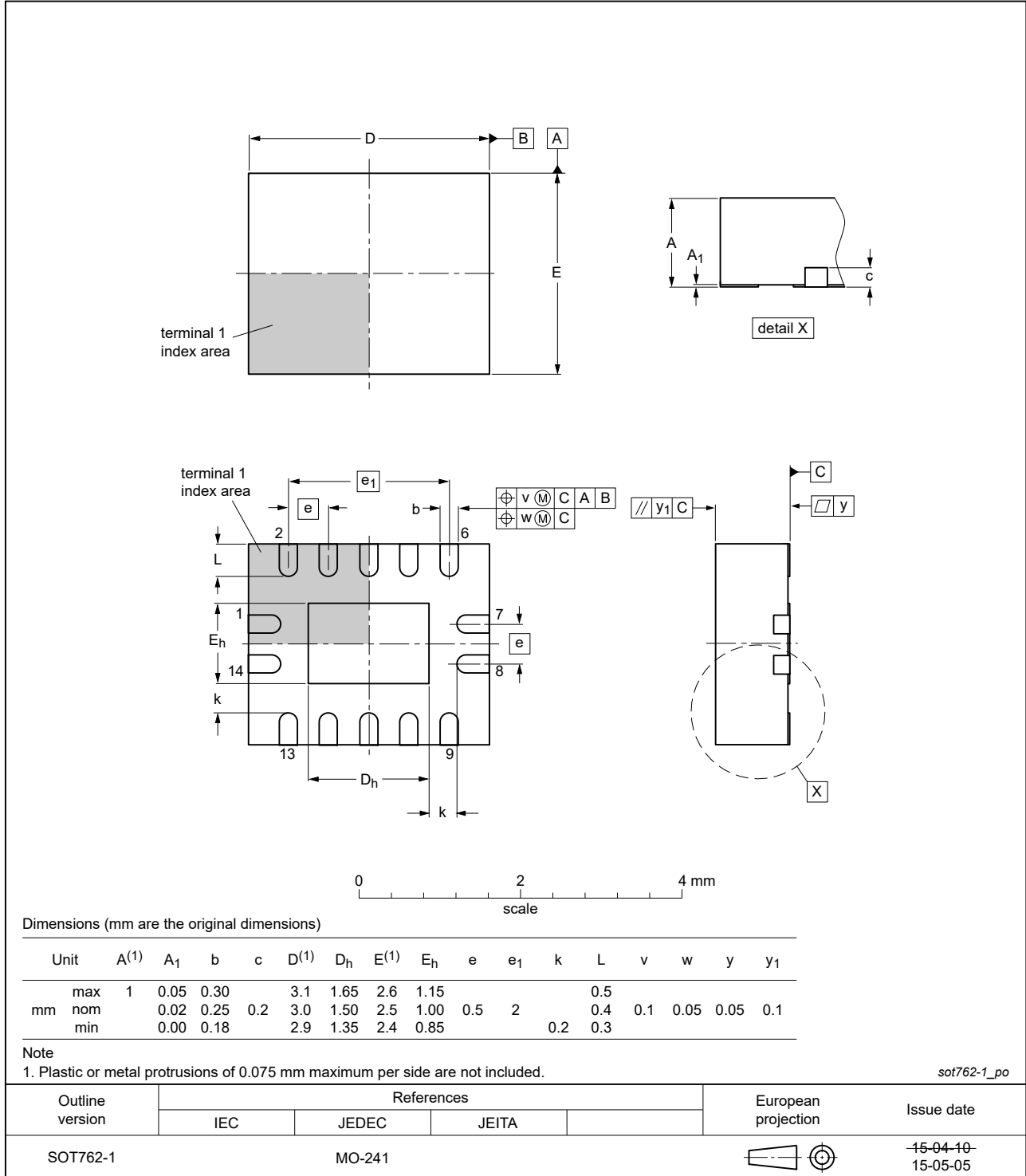

Fig. 8. Package outline SOT762-1 (DHVQFN14)

DHXQFN14: plastic, leadless dual in-line compatible thermal enhanced extreme thin quad flat package; no leads; 14 terminals; 0.4 mm pitch; body 2 mm x 2 mm x 0.48 mm

SOT8014-1

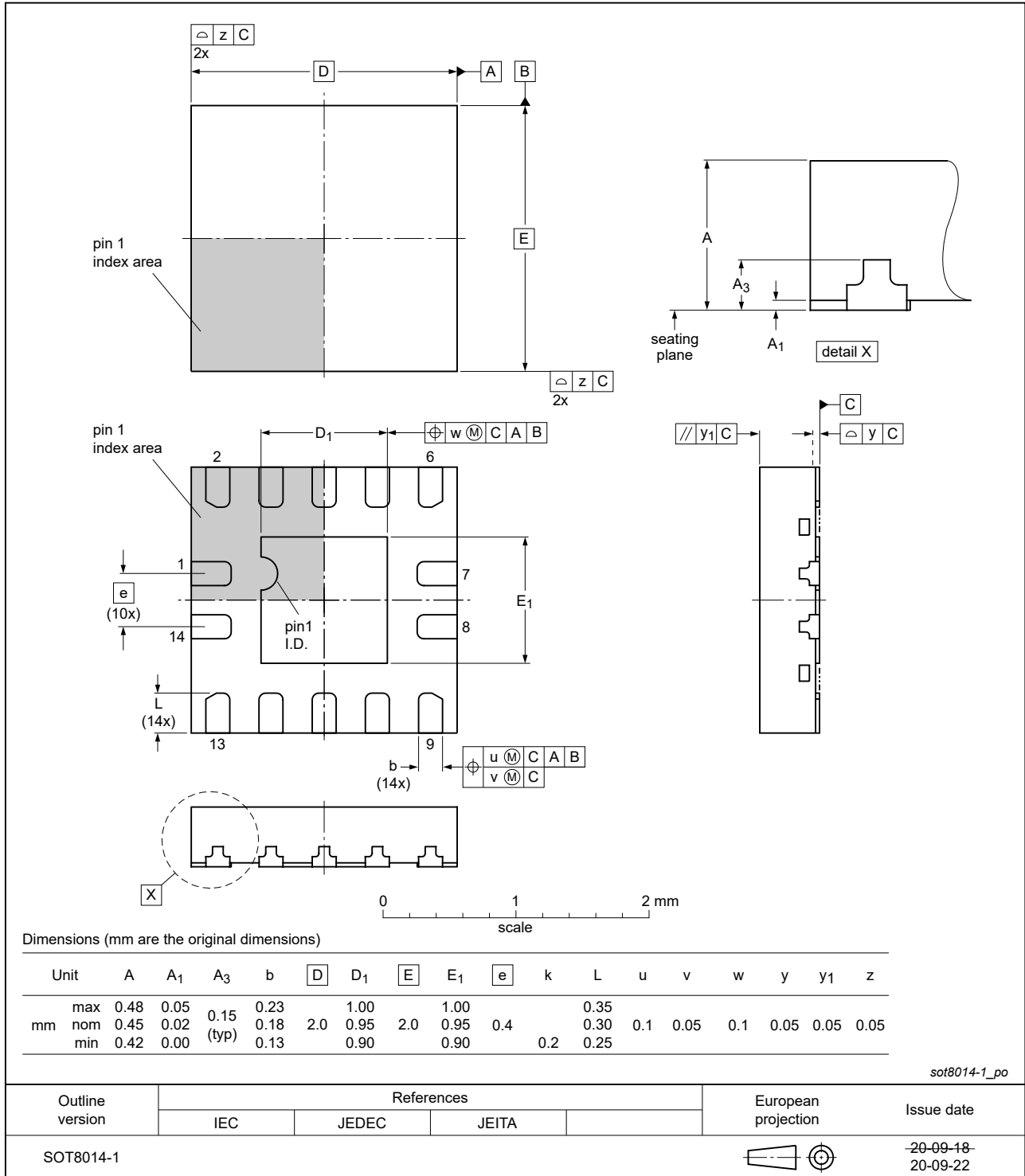

Fig. 9. Package outline SOT8014-1 (DHXQFN14)

## 12. Abbreviations

Table 10. Abbreviations

Acronym	Description
CDM	Charged Device Model
CMOS	Complementary Metal-Oxide Semiconductor
DUT	Device Under Test
ESD	ElectroStatic Discharge
HBM	Human Body Model
TTL	Transistor-Transistor Logic

## 13. Revision history

Table 11. Revision history

Document ID	Release date	Data sheet status	Change notice	Supersedes
74HC_HCT04 v.10	20240216	Product data sheet	-	74HC_HCT04 v.9
Modifications:	<ul style="list-style-type: none"> <li>• <a href="#">Section 2</a>: ESD specification updated according to the latest JEDEC standard.</li> <li>• <a href="#">Fig. 6</a>, <a href="#">Fig. 7</a>: Aligned SO and TSSOP package outline drawings to JEDEC MS-012 and MO-153</li> </ul>			
74HC_HCT04 v.9	20230209	Product data sheet	-	74HC_HCT04 v.8
Modifications:	<ul style="list-style-type: none"> <li>• Added type numbers 74HC04BZ and 74HCT04BZ (SOT8014-1/DHXQFN14).</li> </ul>			
74HC_HCT04 v.8	20210810	Product data sheet	-	74HC_HCT04 v.7
Modifications:	<ul style="list-style-type: none"> <li>• Type number 74HC04DB (SOT337-1/SSOP14) removed.</li> </ul>			
74HC_HCT04 v.7	20210205	Product data sheet	-	74HC_HCT04 v.6
Modifications:	<ul style="list-style-type: none"> <li>• Type number 74HCT04DB (SOT337-1/SSOP14) removed.</li> </ul>			
74HC_HCT04 v.6	20200609	Product data sheet	-	74HC_HCT04 v.5
Modifications:	<ul style="list-style-type: none"> <li>• The format of this data sheet has been redesigned to comply with the identity guidelines of Nexperia.</li> <li>• Legal texts have been adapted to the new company name where appropriate.</li> <li>• <a href="#">Section 2</a> updated.</li> <li>• <a href="#">Table 4</a>: Derating values for <math>P_{tot}</math> total power dissipation have been updated.</li> </ul>			
74HC_HCT04 v.5	20151127	Product data sheet	-	74HC_HCT04 v.4
Modifications:	<ul style="list-style-type: none"> <li>• Type numbers 74HC04N and 74HCT04N (SOT27-1) removed.</li> </ul>			
74HC_HCT04 v.4	20120803	Product data sheet	-	74HC_HCT04 v.3
Modifications:	<ul style="list-style-type: none"> <li>• The format of this data sheet has been redesigned to comply with the new identity guidelines of NXP Semiconductors.</li> <li>• Legal texts have been adapted to the new company name where appropriate.</li> </ul>			
74HC_HCT04 v.3	20030723	Product data sheet	-	74HC_HCT04_CNV v.2
74HC_HCT04_CNV v.2	19970826	Product specification	-	-

## 14. Legal information

### Data sheet status

Document status [1][2]	Product status [3]	Definition
Objective [short] data sheet	Development	This document contains data from the objective specification for product development.
Preliminary [short] data sheet	Qualification	This document contains data from the preliminary specification.
Product [short] data sheet	Production	This document contains the product specification.

- [1] Please consult the most recently issued document before initiating or completing a design.
- [2] The term 'short data sheet' is explained in section "Definitions".
- [3] The product status of device(s) described in this document may have changed since this document was published and may differ in case of multiple devices. The latest product status information is available on the internet at <https://www.nexperia.com>.

### Definitions

**Draft** — The document is a draft version only. The content is still under internal review and subject to formal approval, which may result in modifications or additions. Nexperia does not give any representations or warranties as to the accuracy or completeness of information included herein and shall have no liability for the consequences of use of such information.

**Short data sheet** — A short data sheet is an extract from a full data sheet with the same product type number(s) and title. A short data sheet is intended for quick reference only and should not be relied upon to contain detailed and full information. For detailed and full information see the relevant full data sheet, which is available on request via the local Nexperia sales office. In case of any inconsistency or conflict with the short data sheet, the full data sheet shall prevail.

**Product specification** — The information and data provided in a Product data sheet shall define the specification of the product as agreed between Nexperia and its customer, unless Nexperia and customer have explicitly agreed otherwise in writing. In no event however, shall an agreement be valid in which the Nexperia product is deemed to offer functions and qualities beyond those described in the Product data sheet.

### Disclaimers

**Limited warranty and liability** — Information in this document is believed to be accurate and reliable. However, Nexperia does not give any representations or warranties, expressed or implied, as to the accuracy or completeness of such information and shall have no liability for the consequences of use of such information. Nexperia takes no responsibility for the content in this document if provided by an information source outside of Nexperia.

In no event shall Nexperia be liable for any indirect, incidental, punitive, special or consequential damages (including - without limitation - lost profits, lost savings, business interruption, costs related to the removal or replacement of any products or rework charges) whether or not such damages are based on tort (including negligence), warranty, breach of contract or any other legal theory.

Notwithstanding any damages that customer might incur for any reason whatsoever, Nexperia's aggregate and cumulative liability towards customer for the products described herein shall be limited in accordance with the Terms and conditions of commercial sale of Nexperia.

**Right to make changes** — Nexperia reserves the right to make changes to information published in this document, including without limitation specifications and product descriptions, at any time and without notice. This document supersedes and replaces all information supplied prior to the publication hereof.

**Suitability for use** — Nexperia products are not designed, authorized or warranted to be suitable for use in life support, life-critical or safety-critical systems or equipment, nor in applications where failure or malfunction of an Nexperia product can reasonably be expected to result in personal

injury, death or severe property or environmental damage. Nexperia and its suppliers accept no liability for inclusion and/or use of Nexperia products in such equipment or applications and therefore such inclusion and/or use is at the customer's own risk.

**Quick reference data** — The Quick reference data is an extract of the product data given in the Limiting values and Characteristics sections of this document, and as such is not complete, exhaustive or legally binding.

**Applications** — Applications that are described herein for any of these products are for illustrative purposes only. Nexperia makes no representation or warranty that such applications will be suitable for the specified use without further testing or modification.

Customers are responsible for the design and operation of their applications and products using Nexperia products, and Nexperia accepts no liability for any assistance with applications or customer product design. It is customer's sole responsibility to determine whether the Nexperia product is suitable and fit for the customer's applications and products planned, as well as for the planned application and use of customer's third party customer(s). Customers should provide appropriate design and operating safeguards to minimize the risks associated with their applications and products.

Nexperia does not accept any liability related to any default, damage, costs or problem which is based on any weakness or default in the customer's applications or products, or the application or use by customer's third party customer(s). Customer is responsible for doing all necessary testing for the customer's applications and products using Nexperia products in order to avoid a default of the applications and the products or of the application or use by customer's third party customer(s). Nexperia does not accept any liability in this respect.

**Limiting values** — Stress above one or more limiting values (as defined in the Absolute Maximum Ratings System of IEC 60134) will cause permanent damage to the device. Limiting values are stress ratings only and (proper) operation of the device at these or any other conditions above those given in the Recommended operating conditions section (if present) or the Characteristics sections of this document is not warranted. Constant or repeated exposure to limiting values will permanently and irreversibly affect the quality and reliability of the device.

**Terms and conditions of commercial sale** — Nexperia products are sold subject to the general terms and conditions of commercial sale, as published at <http://www.nexperia.com/profile/terms>, unless otherwise agreed in a valid written individual agreement. In case an individual agreement is concluded only the terms and conditions of the respective agreement shall apply. Nexperia hereby expressly objects to applying the customer's general terms and conditions with regard to the purchase of Nexperia products by customer.

**No offer to sell or license** — Nothing in this document may be interpreted or construed as an offer to sell products that is open for acceptance or the grant, conveyance or implication of any license under any copyrights, patents or other industrial or intellectual property rights.

**Export control** — This document as well as the item(s) described herein may be subject to export control regulations. Export might require a prior authorization from competent authorities.

**Non-automotive qualified products** — Unless this data sheet expressly states that this specific Nexperia product is automotive qualified, the product is not suitable for automotive use. It is neither qualified nor tested in accordance with automotive testing or application requirements. Nexperia accepts no liability for inclusion and/or use of non-automotive qualified products in automotive equipment or applications.

In the event that customer uses the product for design-in and use in automotive applications to automotive specifications and standards, customer (a) shall use the product without Nexperia's warranty of the product for such automotive applications, use and specifications, and (b) whenever customer uses the product for automotive applications beyond Nexperia's specifications such use shall be solely at customer's own risk, and (c) customer fully indemnifies Nexperia for any liability, damages or failed product claims resulting from customer design and use of the product for automotive applications beyond Nexperia's standard warranty and Nexperia's product specifications.

**Translations** — A non-English (translated) version of a document is for reference only. The English version shall prevail in case of any discrepancy between the translated and English versions.

### Trademarks

Notice: All referenced brands, product names, service names and trademarks are the property of their respective owners.

## Contents

---

<b>1. General description</b> .....	<b>1</b>
<b>2. Features and benefits</b> .....	<b>1</b>
<b>3. Ordering information</b> .....	<b>1</b>
<b>4. Functional diagram</b> .....	<b>2</b>
<b>5. Pinning information</b> .....	<b>3</b>
5.1. Pinning.....	3
5.2. Pin description.....	3
<b>6. Functional description</b> .....	<b>4</b>
<b>7. Limiting values</b> .....	<b>4</b>
<b>8. Recommended operating conditions</b> .....	<b>4</b>
<b>9. Static characteristics</b> .....	<b>5</b>
<b>10. Dynamic characteristics</b> .....	<b>7</b>
10.1. Waveforms and test circuit.....	8
<b>11. Package outline</b> .....	<b>9</b>
<b>12. Abbreviations</b> .....	<b>13</b>
<b>13. Revision history</b> .....	<b>13</b>
<b>14. Legal information</b> .....	<b>14</b>

---



© Nexperia B.V. 2024. All rights reserved

For more information, please visit: <http://www.nexperia.com>  
For sales office addresses, please send an email to: [salesaddresses@nexperia.com](mailto:salesaddresses@nexperia.com)  
Date of release: 16 February 2024



---

## Looking for pricing, stock, or lifecycle information?

Click below to explore more details on WIN SOURCE:

-  [View 74HCT04BQ,115 on WIN SOURCE](#)
-  [Nexperia USA Inc. Information](#)

## Optimize Your Supply Chain with WIN SOURCE Solutions

-  Global Sourcing Solution
-  Obsolete Management
-  Cost Control Management
-  Shortage Management
-  Alternative Solution
-  Excess Inventory Management