



**THE DATASHEET OF
BPSC00070740101MS0**



SMD Shielded Power Inductors

BPSC Series



Features

- RoHS, Halogen Free and REACH Compliance
- Magnetic shielded
- Various package size and wide inductance range

Applications

- AP Routers
- STBs
- LCD TVs and monitors
- Game consoles
- LED lightings
- DC/DC converters

Product Identification

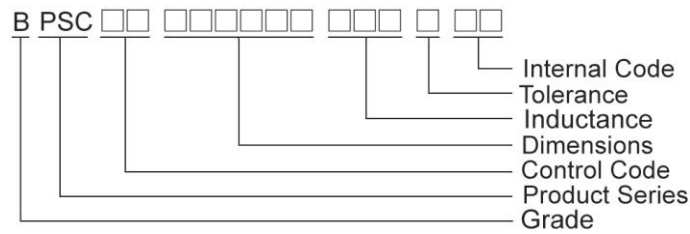

Shape and Dimensions

BPSC00030312/030316/030320

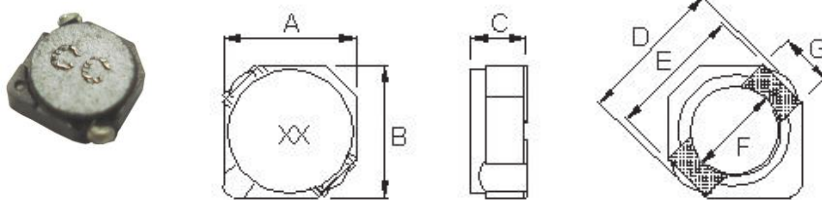

Recommended Pattern

Dimension in mm

TYPE	Shape and Dimensions							Recommended Pattern			
	A	B	C	D	E	F	G	A	B	C	D
BPSC00030316	3.2 ⁺⁰	3.2 ⁺⁰	1.55 ⁺⁰	4.5 ⁺⁰	3.3	2.1	1.0	1.3	1.7	1.3	4.3
BPSC000303020	3.2 ⁺⁰	3.2 ⁺⁰	2.0 ⁺⁰	4.5 ⁺⁰	3.3	2.1	1.0	1.3	1.7	1.3	4.3

Shape and Dimensions

BPSC00040412

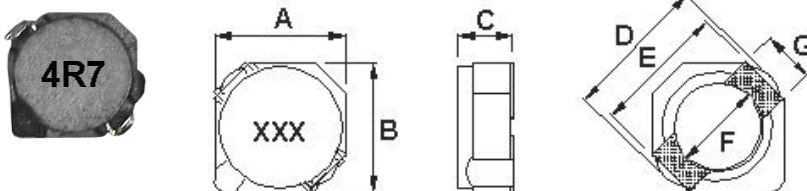

Recommended Pattern

Dimension in mm

TYPE	Shape and Dimensions							Recommended Pattern			
	A	B	C	D	E	F	G	A	B	C	D
BPSC00040412	4 ⁺⁰	4 ⁺⁰	1.2 ⁺⁰	5.2 ⁺⁰	4.4	2.8	1.1	1.4	2.4	1.5	5.2

Shape and Dimensions

BPSC00040418

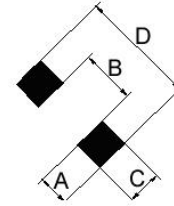
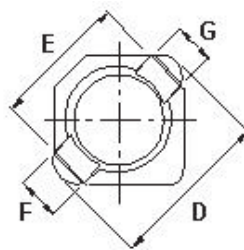
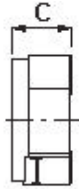
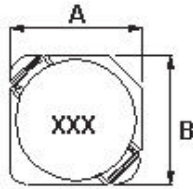

Dimensions in mm

TYPE	Shape and Dimensions							Recommended Pattern			
	A	B	C	D	E	F	G	A	B	C	D
BPSC00040418	4 ⁺⁰	4 ⁺⁰	1.8 ⁺⁰	5.2 ⁺⁰	4.4Typ	1.4 ⁺⁰	1.1Typ	1.4	2.4	1.5	5.2

Shape and Dimensions

BPSC00404030

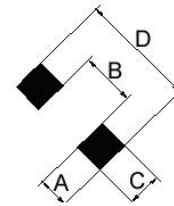
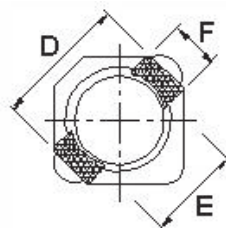
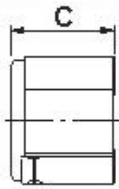
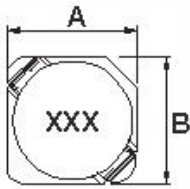

Dimension in mm

TYPE	Shape and Dimensions						Recommended Pattern			
	A	B	C	D	E	F	A	B	C	D
BPSC00404030	4 ⁺⁰	4 ⁺⁰	3 ⁺⁰	4.4	2.8	1.1	1.4	2.4	1.5	5.2

Electrical Characteristics

Part Number	Inductance (μ H)	Tolerance (\pm %)	Test Frequency	RDC (Ω)Max	Isat(A) Max(Typ.)	Irms (A)Typ.	Marking
BPSC00030316R47□00	0.47	30	100 kHz,1 V	0.04	2.00(2.80)		AO
BPSC000303161R5□00	1.5	30	100 kHz,1 V	0.063	1.40(1.80)	2	BF
BPSC000303161R8□00	1.8	30	100 kHz,1 V	0.075	1.30(1.70)	1.8	BI
BPSC000303162R2□00	2.2	30	100 kHz,1 V	0.094	1.20(1.60)	1.6	CC
BPSC000303162R7□00	2.7	30	100 kHz,1 V	0.106	1.10(1.40)	1.4	CH
BPSC000303163R3□00	3.3	30	100 kHz,1 V	0.125	0.95(1.20)	1.24	DD
BPSC000303163R9□00	3.9	30	100 kHz,1 V	0.138	0.92(1.10)	1.12	DJ
BPSC000303164R1□00	4.1	20,30	100 kHz,1 V	0.169	0.80(1.00)	1	EA
BPSC000303164R7□00	4.7	20,30	100 kHz,1 V	0.169	0.80(1.00)	1	EH
BPSC000303165R6□00	5.6	20,30	100 kHz,1 V	0.188	0.76(0.95)	0.98	FG
BPSC000303166R8□00	6.8	20,30	100 kHz,1 V	0.213	0.71(0.88)	0.92	GI
BPSC000303168R2□00	8.2	20,30	100 kHz,1 V	0.281	0.64(0.80)	0.8	IC
BPSC00030316100□00	10	20,30	100 kHz,1 V	0.294	0.57(0.72)	0.76	KA
BPSC00030316120□00	12	20,30	100 kHz,1 V	0.394	0.52(0.65)	0.64	QA

Note: When ordering, please specify tolerance code. Tolerance: M= \pm 20% , T= \pm 30%

- Operating temperature range - 30°C ~ 100°C(Including self - temperature rise)
- Isat for Inductance drop 35% from its value with current
- Irms for a 40°C temperature rise from 25°C ambient.
- RDC test method: place testing device to the 2 solder ends of winding and test the value.
- Measure Equipment :
 - L : Agilent/ E4980 or HP4284A
 - RDC : Chroma 16502
 - Isat : HP4284+42841A or WK3260B+WK3265B
 - Irms : HP4284+42841A or WK3260B+WK3265B

Electrical Characteristics

Part Number	Inductance (μ H)	Tolerance (\pm %)	Test Frequency	RDC (Ω)Max	Isat(A) Max(Typ.)	Irms (A)Typ.	Marking
BPSC000303202R2□LD	2.2	20,30	100 kHz,1V	0.041	0.85(1.10)	2.3	CC
BPSC000303203R3□LD	3.3	20,30	100 kHz,1V	0.054	0.75(0.95)	2.1	DD
BPSC000303204R7□LD	4.7	20,30	100 kHz,1V	0.078	0.63(0.78)	1.65	EH
BPSC000303206R8□LD	6.8	20,30	100 kHz,1V	0.106	0.52(0.65)	1.32	GI
BPSC00030320100□LD	10	20,30	100 kHz,1V	0.18	0.43(0.53)	1	KA
BPSC00030320150□LD	15	20,30	100 kHz,1V	0.22	0.35(0.45)	0.8	MA
BPSC00030320220□LD	22	20,30	100 kHz,1V	0.32	0.30(0.36)	0.68	LA
BPSC00030320330□LD	33	20,30	100 kHz,1V	0.46	0.24(0.31)	0.56	NA
BPSC00030320390□LD	39	20,30	100 kHz,1V	0.6	0.21(0.28)		PA
BPSC00030320470□LD	47	20,30	100 kHz,1V	0.66	0.19(0.24)	0.48	OA

Note: When ordering, please specify tolerance code. Tolerance: M= \pm 20% , T= \pm 30%

- Operating temperature range - 30°C ~ 100°C(Including self - temperature rise)
- Isat for Inductance drop 35% from its value with current
- Irms for a 40°C temperature rise from 25°C ambient.
- RDC test method: place testing device to the 2 solder ends of winding and test the value.
- Measure Equipment :
 L : Agilent/ E4980 or HP4284A
 RDC : Chroma 16502
 Isat : HP4284+42841A or WK3260B+WK3265B
 Irms : HP4284+42841A or WK3260B+WK3265B

Electrical Characteristics

Part Number	Inductance (μ H)	Tolerance (\pm %)	Test Frequency	RDC (Ω)Max	Isat(A) Max(Typ.)	Irms (A)Typ.	Marking
BPSC000303201R5□HP	1.5	30	100kHz,1V	0.05	1.90(2.40)	2.2	BF
BPSC000303201R7□HP	1.7	20,30	100kHz,1V	0.05	1.85(2.40)	2.2	BH
BPSC000303202R2□HP	2.2	20,30	100kHz,1V	0.06	1.60(2.30)	1.9	CC
BPSC000303203R3□HP	3.3	20,30	100kHz,1V	0.097	1.45(1.80)	1.55	DD
BPSC000303204R7□HP	4.7	20,30	100kHz,1V	0.14	1.00(1.50)	1.2	EH
BPSC000303206R3□HP	6.3	20,30	100kHz,1V	0.18	0.96(1.30)	1.15	GD
BPSC000303206R8□HP	6.8	20,30	100kHz,1V	0.195	0.95(1.20)	1.1	GI
BPSC00030320100□HP	10	20,30	100kHz,1V	0.285	0.85(1.00)	0.9	KA
BPSC00030320150□HP	15	20,30	100kHz,1V	0.41	0.67(0.83)	0.64	MA
BPSC00030320220□HP	22	20,30	100kHz,1V	0.65	0.50(0.67)	0.6	LA

Note: When ordering, please specify tolerance code. Tolerance: M= \pm 20% , T= \pm 30%

- Operating temperature range - 30°C ~ 100°C(Including self - temperature rise)
- Isat for Inductance drop 35% from its value with current
- I rms for a 40°C temperature rise from 25°C ambient.
- RDC test method: place testing device to the 2 solder ends of winding and test the value.
- Measure Equipment :
 L : Agilent/ E4980 or HP4284A
 RDC : Chroma 16502
 Isat : HP4284+42841A or WK3260B+WK3265B
 I rms : HP4284+42841A or WK3260B+WK3265B

Electrical Characteristics

Part Number	Inductance (μ H)	Tolerance (\pm %)	Test Frequency	RDC (Ω)Max	Rated Current (A)	Irms (A)Typ.	Marking
BPSC000404122R7□00	2.7	30	100 kHz, 1 V	0.078	0.53	1.82	2R7
BPSC000404124R7□00	4.7	20,30	100 kHz, 1 V	0.123	0.4	1.38	4R7
BPSC000404126R8□00	6.8	30	100 kHz, 1 V	0.18	0.34	1.05	6R8
BPSC000404128R2□00	8.2	30	100 kHz, 1 V	0.204	0.32	0.93	8R2
BPSC00040412100□00	10	20,30	100 kHz, 1 V	0.24	0.28	0.9	100
BPSC00040412120□00	12	20,30	100 kHz, 1 V	0.276	0.25	0.81	120
BPSC00040412150□00	15	20,30	100 kHz, 1 V	0.372	0.23	0.68	150
BPSC00040412180□00	18	20,30	100 kHz, 1 V	0.468	0.21	0.58	180
BPSC00040412220□00	22	20,30	100 kHz, 1 V	0.54	0.19	0.53	220
BPSC00040412270□00	27	20,30	100 kHz, 1 V	0.726	0.17	0.48	270
BPSC00040412330□00	33	20,30	100 kHz, 1 V	0.822	0.15	0.41	330
BPSC00040412390□00	39	20,30	100 kHz, 1 V	0.942	0.14	0.4	390

Note: When ordering, please specify tolerance code. Tolerance: M= \pm 20% , T= \pm 30%

- Operating temperature range - 30°C ~ 100°C(Including self - temperature rise)
- Rated current for Inductance drop 35% from its value with current
- I rms for a 40°C temperature rise from 25°C ambient.
- RDC test method: place testing device to the 2 solder ends of winding and test the value.
- Measure Equipment :
 L : Agilent/ E4980 or HP4284A
 RDC : Chroma 16502
 Rated current : HP4284+42841A or WK3260B+WK3265B
 I rms : HP4284+42841A or WK3260B+WK3265B

Electrical Characteristics

Part Number	Inductance (μ H)	Tolerance (\pm %)	Test Frequency	RDC (Ω)Max	Rated Current (A)	Irms (A)Typ.	Marking
BPSC00040412R60□HP	0.6	30	100 kHz,1 V	0.059	2.9	1.8	R60
BPSC000404121R2□HP	1.2	30	100 kHz,1 V	0.082	2	1.7	1R2
BPSC000404121R5□HP	1.5	30	100 kHz,1 V	0.104	1.85	1.45	1R5
BPSC000404122R2□HP	2.2	30	100 kHz,1 V	0.143	1.6	1.15	2R2
BPSC000404123R3□HP	3.3	30	100 kHz,1 V	0.182	1.25	0.95	3R3
BPSC000404124R7□HP	4.7	30	100 kHz,1 V	0.2	1.2	0.9	4R7
BPSC000404126R8□HP	6.8	30	100 kHz,1 V	0.377	0.85	0.7	6R8
BPSC00040412100□HP	10	20,30	100 kHz,1 V	0.413	0.8	0.6	100
BPSC00040412120□HP	12	20,30	100 kHz,1 V	0.585	0.64	0.48	120
BPSC00040412150□HP	15	20,30	100 kHz,1 V	0.653	0.58	0.45	150
BPSC00040412180□HP	18	20,30	100 kHz,1 V	0.888	0.52	0.4	180
BPSC00040412220□HP	22	20,30	100 kHz,1 V	0.925	0.53	0.33	220

Note: When ordering, please specify tolerance code. Tolerance: M= \pm 20% , T= \pm 30%

- Operating temperature range - 30°C ~ 100°C(Including self - temperature rise)
- Rated current for Inductance drop 35% from its value with current
- I rms for a 40°C temperature rise from 25°C ambient.
- RDC test method: place testing device to the 2 solder ends of winding and test the value.
- Measure Equipment :
 L : Agilent/ E4980 or HP4284A
 RDC : Chroma 16502
 Rated current : HP4284+42841A or WK3260B+WK3265B
 I rms : HP4284+42841A or WK3260B+WK3265B

Electrical Characteristics

Part Number	Inductance (μ H)	Tolerance (\pm %)	Test Frequency	RDC (Ω)Max	Rated Current (A)	Marking
BPSC000404181R0□S1	1.0	30	100kHz,0.1V	0.04	1.6	1R0
BPSC000404181R5□S1	1.5	30	100kHz,0.1V	0.052	1.55	1R5
BPSC000404182R2□S1	2.2	30	100kHz,0.1V	0.072	1.2	2R2
BPSC000404183R3□S1	3.3	30	100kHz,0.1V	0.085	1.1	3R3
BPSC000404184R7□S1	4.7	20,30	100kHz,0.1V	0.105	0.9	4R7
BPSC000404185R6□S1	5.6	30	100kHz,0.1V	0.135	0.8	5R6
BPSC000404186R8□S1	6.8	20,30	100kHz,0.1V	0.17	0.73	6R8
BPSC000404188R2□S1	8.2	20,30	100kHz,0.1V	0.21	0.55	8R2
BPSC00040418100□S1	10	20,30	100kHz,0.1V	0.21	0.55	100
BPSC00040418150□S1	15	30	100kHz,0.1V	0.295	0.45	150
BPSC00040418220□S1	22	20,30	100kHz,0.1V	0.43	0.4	220
BPSC00040418330□S1	33	30	100kHz,0.1V	0.675	0.32	330
BPSC00040418101□S1	100	30	100kHz,0.1V	2.75	0.13	101

Note: When ordering, please specify tolerance code. Tolerance: M= \pm 20% , T= \pm 30%

- Operating temperature range - 30°C ~ 100°C(Including self - temperature rise)
- Rated current : DC current that will cause L drop approximately 35% over its nominal value or DC current cause the temperature rising approximately 40°C ,whichever is lower.
- RDC test method: place testing device to the 2 solder ends of winding and test the value.
- Measure Equipment :
 L : Agilent/ E4980 or HP4284A
 RDC : Chroma 16502
 Rated current : HP4284+42841A or WK3260B+WK3265B

Electrical Characteristics

Part Number	Inductance (μ H)	Tolerance (\pm %)	Test Frequency	RDC (Ω)Max	Rated Current (A)	Irms (A)Typ.	Marking
BPSC000404301R0□00	1.0	30	100 kHz, 1 V	0.045	2.8	2.5	1R0
BPSC000404303R3□00	3.3	30	100 kHz, 1 V	0.0721	2	1.85	3R3
BPSC000404304R7□00	4.7	30	100 kHz, 1 V	0.0883	1.65	1.62	4R7
BPSC000404306R8□00	6.8	30	100 kHz, 1 V	0.119	1.24	1.32	6R8
BPSC00040430100□00	10	30	100 kHz, 1 V	0.145	1.05	1.18	100
BPSC00040430150□00	15	30	100 kHz, 1 V	0.213	0.9	1.02	150
BPSC00040430220□00	22	30	100 kHz, 1 V	0.335	0.76	0.74	220
BPSC00040430330□00	33	30	100 kHz, 1 V	0.481	0.58	0.63	330
BPSC00040430470□00	47	20,30	100 kHz, 1 V	0.599	0.48	0.56	470

Note: When ordering, please specify tolerance code. Tolerance: M= \pm 20% , T= \pm 30%

- Operating temperature range - 30°C ~ 100°C(Including self - temperature rise)
- Rated current for Inductance drop 35% from its value with current
- Irms for a 40°C temperature rise from 25°C ambient.
- RDC test method: place testing device to the 2 solder ends of winding and test the value.
- Measure Equipment :
 L : Agilent/ E4980 or HP4284A
 RDC : Chroma 16502
 Rated current : HP4284+42841A or WK3260B+WK3265B
 Irms : HP4284+42841A or WK3260B+WK3265B

Electrical Characteristics

Part Number	Inductance (μ H)	Tolerance (\pm %)	Test Frequency	RDC (Ω)Max	Rated Current (A)	Irms (A)Typ.	Marking
BPSC00040430100□LD	10	30	100 kHz,1 V	0.095	0.5	1.52	100
BPSC00040430120□LD	12	30	100 kHz,1 V	0.1	0.45	1.48	120
BPSC00040430150□LD	15	30	100 kHz,1 V	0.115	0.4	1.44	150
BPSC00040430180□LD	18	30	100 kHz,1 V	0.125	0.35	1.37	180
BPSC00040430220□LD	22	30	100 kHz,1 V	0.145	0.33	1.28	220
BPSC00040430270□LD	27	30	100 kHz,1 V	0.175	0.29	1.18	270
BPSC00040430330□LD	33	30	100 kHz,1 V	0.215	0.28	1.15	330
BPSC00040430390□LD	39	30	100 kHz,1 V	0.225	0.25	1	390
BPSC00040430470□LD	47	30	100 kHz,1 V	0.305	0.23	0.81	470
BPSC00040430560□LD	56	30	100 kHz,1 V	0.325	0.2	0.76	560
BPSC00040430680□LD	68	30	100 kHz,1 V	0.47	0.185	0.6	680
BPSC00040430820□LD	82	30	100 kHz,1 V	0.54	0.172	0.58	820
BPSC00040430101□LD	100	30	100 kHz,1 V	0.61	0.16	0.52	101
BPSC00040430121□LD	120	30	100 kHz,1 V	0.755	0.136	0.5	121
BPSC00040430151□LD	150	30	100 kHz,1 V	0.88	0.124	0.48	151
BPSC00040430181□LD	180	30	100 kHz,1 V	1.13	0.119	0.42	181
BPSC00040430221□LD	220	30	100 kHz,1 V	1.27	0.116	0.36	221

Note: When ordering, please specify tolerance code. Tolerance: M=±20% , T=±30%

- Operating temperature range - 30°C ~ 100°C(Including self - temperature rise)
- Rated current for Inductance drop 35% from its value with current
- I rms for a 40°C temperature rise from 25°C ambient.
- RDC test method: place testing device to the 2 solder ends of winding and test the value.
- Measure Equipment :
 L : Agilent/ E4980 or HP4284A
 RDC : Chroma 16502
 Rated current : HP4284+42841A or WK3260B+WK3265B
 I rms : HP4284+42841A or WK3260B+WK3265B

Packaging Specifications

Tape Dimensions

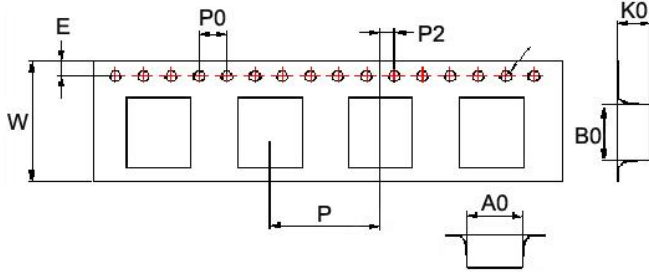

Tape Material

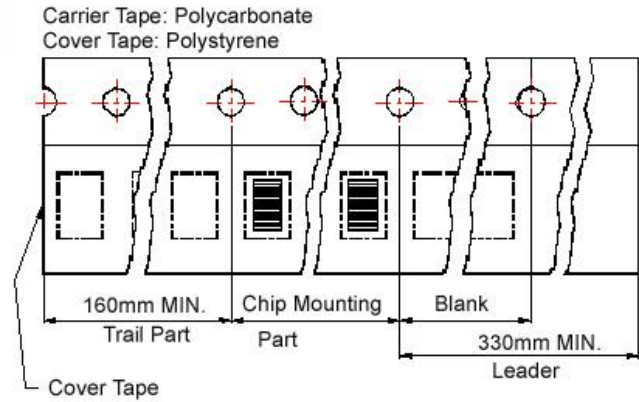

Reel Dimensions

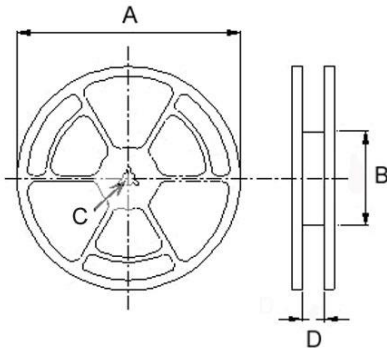

Dimensions in mm

TYPE	Tape Dimensions									Reel Dimensions				Quantity
	A0	B0	K0	D	E	W	P	P0	P2	A	B	C	D	PCS / REEL
BPSC00030316	3.35	3.35	1.7	1.55	1.75	12	8	4	2	178	60	13	13.2	1000
BPSC00030320	3.5	3.5	2.1	1.55	1.75	12	8	4	2	178	60	13	13.2	1000
BPSC00040412	4.2	4.2	1.5	1.55	1.75	12	8	4	2	178	60	13	13.2	1000
BPSC00040418	4.1	4.1	2.0	1.5	1.75	12	8	4	2	178	60	13	13.2	1000
BPSC00040430	4.2	4.2	3.2	1.55	1.75	12	8	4	2	178	60	13	13.2	500

SMD Shielded Power Inductors

BPSC Series

Features

- RoHS, Halogen Free and REACH Compliance
- Magnetic shielded
- Various package size and wide inductance range

Applications

- AP Routers
- STBs
- LCD TVs and monitors
- Game consoles
- LED lightings
- DC/DC converters

Product Identification

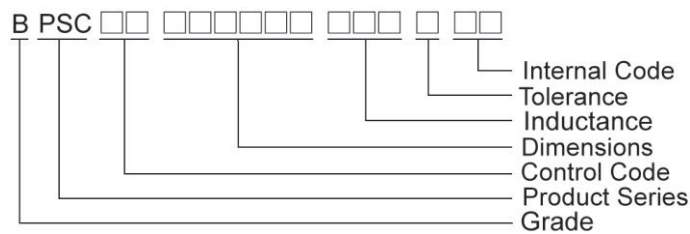

Shape and Dimensions

BPSC00040418

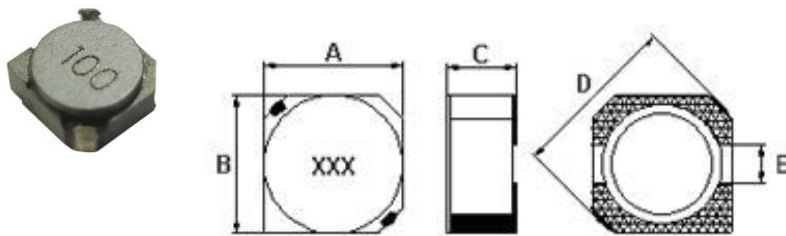

Recommended Pattern

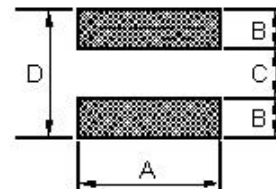

Dimensions in mm

TYPE	Shape and Dimensions					Recommended Pattern			
	A	B	C	D	E	A	B	C	D
BPSC00040418	4 ⁺⁰	4 ⁺⁰	1.8 ⁺⁰	5.2 ⁺⁰	1.0	4.6	1.6	1.4	4.6

Shape and Dimensions

BPSC00050520~050540

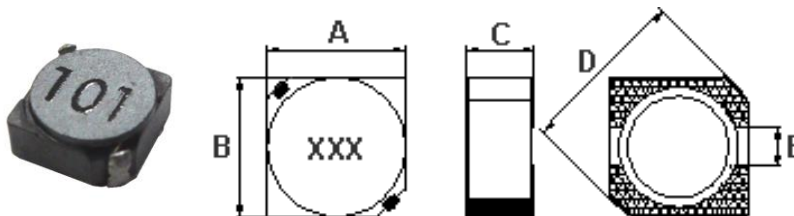

Recommended Pattern

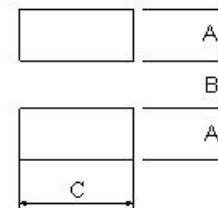

Dimension in mm

TYPE	Shape and Dimensions					Recommended Pattern		
	A	B	C	D	E	A	B	C
BPSC00050520	4.7±0.3	4.7±0.3	2.0 ⁺⁰	6.9 ⁺⁰	1.5	1.9	1.5	5.3
BPSC00050530	4.7±0.3	4.7±0.3	3.0 ⁺⁰	6.9 ⁺⁰	1.5	1.9	1.5	5.3
BPSC00050540	4.7±0.3	4.7±0.3	4 ⁺⁰	6.9 ⁺⁰	1.5	1.9	1.5	5.3

Shape and Dimensions

Recommended Pattern

BPSC00060620~070740

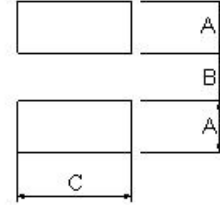
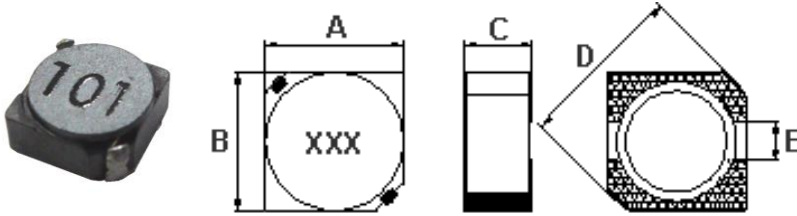

Dimension in mm

TYPE	Shape and Dimensions					Recommended Pattern		
	A	B	C	D	E	A	B	C
BPSC00060620	5.7±0.3	5.7±0.3	2.0 ⁺⁰	8.2 ⁺⁰	2.0	2.15	2.0	6.3
BPSC00060630	5.7±0.3	5.7±0.3	3.0 ⁺⁰	8.2 ⁺⁰	2.0	2.15	2.0	6.3
BPSC00070730	6.7±0.3	6.7±0.3	3.0 ⁺⁰	9.5 ⁺⁰	2.0	2.65	2.0	7.3
BPSC00070740	7 ⁺⁰	7 ⁺⁰	4 ⁺⁰	9.5 ⁺⁰	2.0	2.65	2.0	7.3

Electrical Characteristics

Part Number	Inductance (μ H)	Tolerance (\pm %)	Test Frequency	RDC (Ω)Max	Isat(A) Max(Typ.)	Marking
BPSC000404181R0□S0	1.0	30	100 kHz,0.1 V	0.04	1.35(1.70)	1R0
BPSC000404181R5□S0	1.5	30	100 kHz,0.1 V	0.052	1.25(1.60)	1R5
BPSC000404182R2□S0	2.2	30	100 kHz,0.1 V	0.072	1.00(1.30)	2R2
BPSC000404183R3□S0	3.3	20,30	100 kHz,0.1 V	0.085	0.88(1.10)	3R3
BPSC000404183R6□S0	3.6	30	100 kHz,0.1 V	0.09	0.74(0.93)	3R6
BPSC000404184R7□S0	4.7	20,30	100 kHz,0.1 V	0.105	0.72(0.90)	4R7
BPSC000404186R8□S0	6.8	20,30	100 kHz,0.1 V	0.17	0.61(0.74)	6R8
BPSC00040418100□S0	10	20,30	100 kHz,0.1 V	0.21	0.55(0.60)	100
BPSC00040418150□S0	15	20,30	100 kHz,0.1 V	0.295	0.45(0.52)	150
BPSC00040418220□S0	22	20,30	100 kHz,0.1 V	0.43	0.32(0.40)	220
BPSC00040418270□S0	27	30	100 kHz,0.1 V	0.62	0.30(0.37)	270
BPSC00040418330□S0	33	30	100 kHz,0.1 V	0.675	0.26(0.32)	330
BPSC00040418680□S0	68	30	100 kHz,0.1 V	1.7	0.16(0.21)	680

Note: When ordering, please specify tolerance code. Tolerance: M= \pm 20% , T= \pm 30%

- Operating temperature range - 30°C ~ 100°C(Including self - temperature rise)
- Isat for Inductance drop 35% from its value with current
- RDC test method: place testing device to the 2 solder ends of winding and test the value.
- Measure Equipment :
 L : Agilent/ E4980 or HP4284A
 RDC : Chroma 16502
 Isat : HP4284+42841A or WK3260B+WK3265B

Electrical Characteristics

Part Number	Inductance (μ H)	Tolerance (\pm %)	Test Frequency	RDC (Ω)Max	Isat(A) Max(Typ.)	Marking
BPSC000505201R0□S0	1	30	7.96 MHz, 1 V	0.045	1.72(2.50)	1R0
BPSC00050520R5□S0	1.5	30	7.96 MHz, 1 V	0.06	1.50(1.80)	1R5
BPSC000505201R8□S0	1.8	30	7.96 MHz, 1 V	0.07	1.35(1.70)	1R8
BPSC000505202R2□S0	2.2	20,30	7.96 MHz, 1 V	0.075	1.30(1.60)	2R2
BPSC000505202R7□S0	2.7	30	7.96 MHz, 1 V	0.105	1.20(1.50)	2R7
BPSC000505203R3□S0	3.3	20,30	7.96 MHz, 1 V	0.11	1.04(1.30)	3R3
BPSC000505203R9□S0	3.9	30	7.96 MHz, 1 V	0.155	0.88(1.20)	3R9
BPSC000505204R7□S0	4.7	30	7.96 MHz, 1 V	0.162	0.84(1.10)	4R7
BPSC000505205R6□S0	5.6	30	7.96 MHz, 1 V	0.17	0.80(1.00)	5R6
BPSC000505206R3□S0	6.3	30	7.96 MHz, 1 V	0.18	0.78(0.95)	6R3
BPSC000505206R8□S0	6.8	20,30	7.96 MHz, 1 V	0.2	0.76(0.85)	6R8
BPSC000505208R2□S0	8.2	30	7.96 MHz, 1 V	0.245	0.68(0.80)	8R2
BPSC00050520100□S0	10	20,30	100 kHz, 1 V	0.28	0.61(0.75)	100
BPSC00050520120□S0	12	30	100 kHz, 1 V	0.32	0.56(0.70)	120
BPSC00050520150□S0	15	30	100 kHz, 1 V	0.36	0.50(0.65)	150
BPSC00050520180□S0	18	30	100 kHz, 1 V	0.4	0.48(0.60)	180
BPSC00050520220□S0	22	20,30	100 kHz, 1 V	0.48	0.41(0.55)	220
BPSC00050520270□S0	27	30	100 kHz, 1 V	0.57	0.35(0.50)	270
BPSC00050520330□S0	33	30	100 kHz, 1 V	0.694	0.32(0.45)	330
BPSC00050520390□S0	39	30	100 kHz, 1 V	0.8	0.30(0.40)	390
BPSC00050520470□S0	47	30	100 kHz, 1 V	0.95	0.28(0.38)	470
BPSC00050520560□S0	56	30	100 kHz, 1 V	1.08	0.26(0.35)	560
BPSC00050520680□S0	68	30	100 kHz, 1 V	1.3	0.24(0.34)	680
BPSC00050520101□S0	100	30	100 kHz, 1 V	2	0.20(0.30)	101

Note: When ordering, please specify tolerance code. Tolerance: M=±20% , T=±30%

- Operating temperature range - 30°C ~ 100°C(Including self - temperature rise)
- Isat for Inductance drop 35% from its value with current
- RDC test method: place testing device to the 2 solder ends of winding and test the value.
- Measure Equipment :
 L : Agilent/ E4980 or HP4284A (under 1MHz), HP4285A (over 1MHz)
 RDC : Chroma 16502
 Isat : HP4284+42841A or WK3260B+WK3265B

Electrical Characteristics

Part Number	Inductance (μ H)	Tolerance (\pm %)	Test Frequency	RDC (Ω)Max	Isat(A) Max(Typ.)	Marking
BPSC000505301R2□S0	1.2	30	100 kHz,1 V	0.0236	2.56(4.10)	1R2
BPSC000505301R8□S0	1.8	30	100 kHz,1 V	0.035	2.20(3.20)	1R8
BPSC000505302R0□S0	2.0	30	100 kHz,1 V	0.030	2.10(3.00)	2R0
BPSC000505302R2□S0	2.2	20,30	100 kHz,1 V	0.0313	2.04(2.90)	2R2
BPSC000505302R7□S0	2.7	30	100 kHz,1 V	0.0433	1.60(2.80)	2R7
BPSC000505303R3□S0	3.3	30	100 kHz,1 V	0.0492	1.57(2.30)	3R3
BPSC000505303R9□S0	3.9	30	100 kHz,1 V	0.0648	1.44(2.10)	3R9
BPSC000505304R7□S0	4.7	20,30	100 kHz,1 V	0.072	1.32(2.00)	4R7
BPSC000505305R6□S0	5.6	30	100 kHz,1 V	0.1009	1.17(1.70)	5R6
BPSC000505306R8□S0	6.8	20,30	100 kHz,1 V	0.1089	1.12(1.60)	6R8
BPSC000505308R2□S0	8.2	30	100 kHz,1 V	0.1175	1.04(1.50)	8R2
BPSC00050530100□S0	10	30	100 kHz,1 V	0.1283	1.00(1.30)	100
BPSC00050530120□S0	12	20,30	100 kHz,1 V	0.1316	0.84(1.10)	120
BPSC00050530150□S0	15	30	100 kHz,1 V	0.149	0.76(1.00)	150
BPSC00050530180□S0	18	30	100 kHz,1 V	0.166	0.72(0.99)	180
BPSC00050530220□S0	22	20,30	100 kHz,1 V	0.235	0.70(0.93)	220
BPSC00050530270□S0	27	30	100 kHz,1 V	0.261	0.58(0.83)	270
BPSC00050530330□S0	33	20,30	100 kHz,1 V	0.3313	0.56(0.64)	330
BPSC00050530390□S0	39	20,30	100 kHz,1 V	0.3837	0.50(0.70)	390
BPSC00050530470□S0	47	30	100 kHz,1 V	0.587	0.48(0.61)	470
BPSC00050530560□S0	56	30	100 kHz,1 V	0.6245	0.41(0.54)	560
BPSC00050530680□S0	68	30	100 kHz,1 V	0.699	0.35(0.49)	680
BPSC00050530820□S0	82	30	100 kHz,1 V	0.9148	0.32(0.49)	820
BPSC00050530101□S0	100	20,30	100 kHz,1 V	1.02	0.29(0.45)	101
BPSC00050530121□S0	120	30	100 kHz,1 V	1.27	0.27(0.40)	121
BPSC00050530151□S0	150	30	100 kHz,1 V	1.35	0.24(0.34)	151
BPSC00050530181□S0	180	30	100 kHz,1 V	1.54	0.22(0.32)	181
BPSC00050530221□S0	220	30	100 kHz,1 V	2	0.20(0.29)	221

BPSC00050530331□S0	330	20,30	100 kHz,1 V	3.4	0.19(0.24)	331
BPSC00050530391□S0	390	20,30	100 kHz,1 V	3.56	0.18(0.22)	391
BPSC00050530681□S0	680	20,30	100 kHz,1 V	5.2	0.10(0.17)	681

Note: When ordering, please specify tolerance code. Tolerance: M=±20% , T=±30%

- Operating temperature range - 30°C ~ 100°C(Including self - temperature rise)
- Isat for Inductance drop 35% from its value with current
- RDC test method: place testing device to the 2 solder ends of winding and test the value.
- Measure Equipment :
 L : Agilent/ E4980 or HP4284A (under 1MHz), HP4285A (over 1MHz)
 RDC : Chroma 16502
 Isat : HP4284+42841A or WK3260B+WK3265B

Electrical Characteristics

Part Number	Inductance (μH)	Tolerance (±%)	Test Frequency	RDC (Ω)Max	Isat(A) Max(Typ.)	Irms (A)Typ.	Marking
BPSC000505402R2□S0	2.2	30	100 kHz,1V	0.033	3.5(4.6)	4.3	2R2
BPSC000505403R3□S0	3.3	30	100 kHz,1V	0.039	2.7(3.4)	3.6	3R3
BPSC000505404R7□S0	4.7	20,30	100 kHz,1V	0.053	2.4(3.0)	3	4R7
BPSC000505406R8□S0	6.8	20,30	100 kHz,1V	0.06	2.0(2.6)	2.8	6R8
BPSC00050540100□S0	10	20,30	100 kHz,1V	0.15	1.5(2.0)	1.6	100
BPSC00050540150□S0	15	20,30	100 kHz,1V	0.21	1.2(1.6)	1.35	150
BPSC00050540220□S0	22	20,30	100 kHz,1V	0.27	1.0(1.4)	1	220

Note: When ordering, please specify tolerance code. Tolerance: M=±20% , T=±30%

- Operating temperature range - 30°C ~ 100°C(Including self - temperature rise)
- Isat for Inductance drop 35% from its value with current
- I rms for a 40°C temperature rise from 25°C ambient.
- RDC test method: place testing device to the 2 solder ends of winding and test the value.
- Measure Equipment :
 L : Agilent/ E4980 or HP4284A (under 1MHz)
 RDC : Chroma 16502
 Isat : HP4284+42841A or WK3260B+WK3265B
 I rms : HP4284+42841A or WK3260B+WK3265B

Electrical Characteristics

Part Number	Inductance (μ H)	Tolerance (\pm %)	Test Frequency	RDC (Ω)Max	Isat(A) Max(Typ.)	Marking
BPSC000606201R0□S0	1.0	30	10 kHz, 1 V	0.038	1.00(3.50)	1R0
BPSC000606201R5□S0	1.5	30	10 kHz, 1 V	0.038	2.50(3.00)	1R5
BPSC000606202R0□S0	2.0	30	10 kHz, 1 V	0.045	2.10(2.60)	2R0
BPSC000606202R2□S0	2.2	30	10 kHz, 1 V	0.048	2.00(2.50)	2R2
BPSC000606203R3□S0	3.3	30	10 kHz, 1 V	0.056	1.70(2.00)	3R3
BPSC000606204R1□S0	4.1	30	10 kHz, 1 V	0.057	1.55(1.90)	4R1
BPSC000606204R7□S0	4.7	20,30	10 kHz, 1 V	0.076	1.35(1.70)	4R7
BPSC000606205R4□S0	5.4	30	10 kHz, 1 V	0.076	1.20(1.50)	5R4
BPSC000606206R2□S0	6.2	30	10 kHz, 1 V	0.096	1.10(1.40)	6R2
BPSC000606206R8□S0	6.8	30	10 kHz, 1 V	0.1	1.00(1.30)	6R8
BPSC000606208R9□S0	8.9	30	10 kHz, 1 V	0.116	0.95(1.25)	8R9
BPSC00060620100□S0	10	20,30	10 kHz, 1 V	0.124	0.90(1.20)	100
BPSC00060620120□S0	12	30	10 kHz, 1 V	0.153	0.90(1.00)	120
BPSC00060620150□S0	15	20,30	10 kHz, 1 V	0.196	0.80(0.91)	150
BPSC00060620180□S0	18	30	10 kHz, 1 V	0.21	0.75(0.90)	180
BPSC00060620220□S0	22	20,30	10 kHz, 1 V	0.29	0.65(0.80)	220
BPSC00060620270□S0	27	30	10 kHz, 1 V	0.33	0.60(0.70)	270
BPSC00060620330□S0	33	20,30	10 kHz, 1 V	0.386	0.55(0.65)	330
BPSC00060620390□S0	39	30	10 kHz, 1 V	0.52	0.48(0.60)	390
BPSC00060620470□S0	47	20,30	10 kHz, 1 V	0.595	0.44(0.51)	470
BPSC00060620560□S0	56	30	10 kHz, 1 V	0.665	0.40(0.50)	560
BPSC00060620680□S0	68	30	10 kHz, 1 V	0.84	0.33(0.43)	680
BPSC00060620820□S0	82	30	10 kHz, 1 V	0.978	0.30(0.41)	820
BPSC00060620101□S0	100	20,30	10 kHz, 1 V	1.2	0.25(0.36)	101

Note: When ordering, please specify tolerance code. Tolerance: M=±20% , T=±30%

- Operating temperature range - 30°C ~ 100°C(Including self - temperature rise)
- Isat for Inductance drop 35% from its value with current
- RDC test method: place testing device to the 2 solder ends of winding and test the value.
- Measure Equipment :
 L : Agilent/ E4980 or HP4284A
 RDC : Chroma 16502
 Isat : HP4284+42841A or WK3260B+WK3265B

Electrical Characteristics

Part Number	Inductance (μ H)	Tolerance (\pm %)	Test Frequency	RDC (Ω)Max	Isat(A) Max(Typ.)	Marking
BPSC000606301R0□S0	1.0	30	10 kHz, 1 V	0.015	3.50(4.20)	1R0
BPSC000606301R5□S0	1.5	30	10 kHz, 1 V	0.015	2.80(3.70)	1R5
BPSC000606302R2□S0	2.2	30	10 kHz, 1 V	0.018	2.40(3.10)	2R2
BPSC000606302R5□S0	2.5	30	10 kHz, 1 V	0.022	2.30(2.70)	2R5
BPSC000606302R6□S0	2.6	30	10 kHz, 1 V	0.022	2.20(2.60)	2R6
BPSC000606302R7□S0	2.7	30	10 kHz, 1 V	0.024	2.20(2.60)	2R7
BPSC000606303R0□S0	3.0	30	10 kHz, 1 V	0.024	2.20(2.50)	3R0
BPSC000606303R3□S0	3.3	30	10 kHz, 1 V	0.027	2.10(2.50)	3R3
BPSC000606304R2□S0	4.2	30	10 kHz, 1 V	0.031	2.00(2.20)	4R2
BPSC000606304R3□S0	4.3	30	10 kHz, 1 V	0.041	1.80(2.10)	4R3
BPSC000606304R7□S0	4.7	20,30	10 kHz, 1 V	0.038	1.60(2.00)	4R7
BPSC000606305R0□S0	5.0	30	10 kHz, 1 V	0.038	1.50(1.90)	5R0
BPSC000606305R3□S0	5.3	20,30	10 kHz, 1 V	0.038	1.50(1.90)	5R3
BPSC000606306R2□S0	6.2	20,30	10 kHz, 1 V	0.045	1.20(1.80)	6R2
BPSC000606306R8□S0	6.8	20,30	10 kHz, 1 V	0.05	1.20(1.60)	6R8
BPSC000606308R2□S0	8.2	20,30	10 kHz, 1 V	0.053	1.00(1.50)	8R2
BPSC00060630100□S0	10	20,30	10 kHz, 1 V	0.065	0.95(1.40)	100
BPSC00060630120□S0	12	20,30	10 kHz, 1 V	0.076	0.90(1.30)	120
BPSC00060630150□S0	15	20,30	10 kHz, 1 V	0.103	0.85(1.10)	150
BPSC00060630180□S0	18	30	10 kHz, 1 V	0.11	0.80(1.00)	180
BPSC00060630220□S0	22	20,30	10 kHz, 1 V	0.122	0.75(0.92)	220
BPSC00060630270□S0	27	30	10 kHz, 1 V	0.175	0.65(0.82)	270
BPSC00060630330□S0	33	30	10 kHz, 1 V	0.189	0.60(0.75)	330
BPSC00060630390□S0	39	30	10 kHz, 1 V	0.212	0.55(0.70)	390
BPSC00060630470□S0	47	20,30	10 kHz, 1 V	0.25	0.50(0.62)	470
BPSC00060630560□S0	56	30	10 kHz, 1 V	0.305	0.48(0.59)	560

BPSC00060630680□S0	68	30	10 kHz, 1 V	0.355	0.42(0.52)	680
BPSC00060630820□S0	82	30	10 kHz, 1 V	0.463	0.39(0.46)	820

Note: When ordering, please specify tolerance code. Tolerance: M=±20% , T=±30%

- Operating temperature range - 30°C ~ 100°C(Including self - temperature rise)
- Isat for Inductance drop 35% from its value with current
- RDC test method: place testing device to the 2 solder ends of winding and test the value.
- Measure Equipment :
L : Agilent/ E4980 or HP4284A
RDC : Chroma 16502
Isat : HP4284+42841A or WK3260B+WK3265B

Electrical Characteristics

Part Number	Inductance (μH)	Tolerance (±%)	Test Frequency	RDC (Ω)Max	Isat(A) Max(Typ.)	Marking
BPSC00060630101□S0	100	20,30	10 kHz, 1 V	0.52	0.35(0.42)	101
BPSC00060630181□S0	180	30	10 kHz, 1 V	1.05	0.21(0.31)	181
BPSC00060630221□S0	220	30	10 kHz, 1 V	1.2	0.20(0.30)	221
BPSC00060630331□S0	330	20,30	10 kHz, 1 V	1.7	0.15(0.24)	331
BPSC00060630391□S0	390	30	10 kHz, 1 V	1.8	0.13(0.22)	391
BPSC00060630471□S0	470	20,30	10 kHz, 1 V	2.5	0.11(0.21)	471
BPSC00060630561□S0	560	20,30	10 kHz, 1 V	3.2	0.10(0.17)	561

Note: When ordering, please specify tolerance code. Tolerance: M=±20% , T=±30% , N=+40% -20%

- Operating temperature range - 30°C ~ 100°C(Including self - temperature rise)
- Isat for Inductance drop 35% from its value with current
- RDC test method: place testing device to the 2 solder ends of winding and test the value.
- Measure Equipment :
L : Agilent/ E4980 or HP4284A
RDC : Chroma 16502
Isat : HP4284+42841A or WK3260B+WK3265B

Electrical Characteristics

Part Number	Inductance (μ H)	Tolerance (\pm %)	Test Frequency	RDC (Ω)Max	Isat(A) Max(Typ.)	Marking
BPSC000707301R0□S0	1.0	30	10 kHz,1 V	0.024	3.50(5.30)	1R0
BPSC000707301R5□S0	1.5	30	10 kHz,1 V	0.0195	3.40(4.50)	1R5
BPSC000707302R2□S0	2.2	20,30	10 kHz,1 V	0.035	3.00(3.40)	2R2
BPSC000707303R0□S0	3	30	10 kHz,1 V	0.024	2.60(3.20)	3R0
BPSC000707303R3□S0	3.3	30	10 kHz,1 V	0.025	2.50(3.10)	3R3
BPSC000707303R9□S0	3.9	30	10 kHz,1 V	0.027	2.30(2.90)	3R9
BPSC000707304R7□S0	4.7	20,30	10 kHz,1 V	0.031	1.92(2.40)	4R7
BPSC000707305R0□S0	5.0	30	10 kHz,1 V	0.031	1.74(2.40)	5R0
BPSC000707306R0□S0	6.0	30	10 kHz,1 V	0.035	1.70(2.25)	6R0
BPSC000707306R2□S0	6.2	20,30	10 kHz,1 V	0.051	1.40(2.20)	6R2
BPSC000707306R8□S0	6.8	20,30	10 kHz,1 V	0.05	1.30(2.15)	6R8
BPSC000707307R3□S0	7.3	30	10 kHz,1 V	0.054	1.25(2.10)	7R3
BPSC000707308R6□S0	8.6	30	10 kHz,1 V	0.058	1.20(1.85)	8R6
BPSC00070730100□S0	10	20,30	10 kHz,1 V	0.065	1.15(1.70)	100
BPSC00070730120□S0	12	20,30	10 kHz,1 V	0.07	1.14(1.50)	120
BPSC00070730150□S0	15	20,30	10 kHz,1 V	0.084	1.12(1.40)	150
BPSC00070730180□S0	18	30	10 kHz,1 V	0.095	1.02(1.32)	180
BPSC00070730220□S0	22	30	10 kHz,1 V	0.128	0.87(1.20)	220
BPSC00070730270□S0	27	30	10 kHz,1 V	0.142	0.82(1.05)	270
BPSC00070730330□S0	33	30	10 kHz,1 V	0.165	0.80(0.97)	330
BPSC00070730390□S0	39	30	10 kHz,1 V	0.21	0.79(0.90)	390
BPSC00070730470□S0	47	20,30	10 kHz,1 V	0.238	0.70(0.80)	470
BPSC00070730560□S0	56	30	10 kHz,1 V	0.277	0.60(0.73)	560
BPSC00070730680□S0	68	30	10 kHz,1 V	0.304	0.55(0.65)	680
BPSC00070730820□S0	82	30	10 kHz,1 V	0.39	0.48(0.60)	820
BPSC00070730101□S0	100	30	10 kHz,1 V	0.535	0.43(0.54)	101
BPSC00070730121□S0	120	20,30	10 kHz,1 V	0.6	0.36(0.45)	121
BPSC00070730221□S0	220	20,30	10 kHz,1 V	1.3	0.27(0.34)	221

Note: When ordering, please specify tolerance code. Tolerance: M=±20% , T=±30%

- Operating temperature range - 30°C ~ 100°C(Including self - temperature rise)
- Isat for Inductance drop 35% from its value with current
- RDC test method: place testing device to the 2 solder ends of winding and test the value.
- Measure Equipment :
 L : Agilent/ E4980 or HP4284A
 RDC : Chroma 16502
 Isat : HP4284+42841A or WK3260B+WK3265B

Electrical Characteristics

Part Number	Inductance (μH)	Tolerance (±%)	Test Frequency	RDC (Ω)Max	Isat(A) Max(Typ.)	Marking
BPSC000707402R2□S0	2.2	30	10 kHz,0.1 V	0.018	3.80(4.70)	2R2
BPSC000707402R7□S0	2.7	30	10 kHz,0.1 V	0.02	3.20(4.00)	2R7
BPSC000707403R3□S0	3.3	20,30	10 kHz,0.1 V	0.023	3.00(3.80)	3R3
BPSC000707404R7□S0	4.7	20,30	10 kHz,0.1 V	0.025	2.70(3.40)	4R7
BPSC000707405R0□S0	5	20,30	10 kHz,0.1 V	0.026	2.50(3.10)	5R0
BPSC000707405R6□S0	5.6	30	10 kHz,0.1 V	0.027	2.30(3.00)	5R6
BPSC000707406R2□S0	6.2	20,30	10 kHz,0.1 V	0.027	1.80(2.80)	6R2
BPSC000707406R8□S0	6.8	30	10 kHz,0.1 V	0.032	1.70(2.70)	6R8
BPSC000707407R4□S0	7.4	30	10 kHz,0.1 V	0.032	1.70(2.50)	7R4
BPSC000707408R7□S0	8.7	30	10 kHz,0.1 V	0.034	1.70(2.40)	8R7
BPSC00070740100□S0	10	20,30	10 kHz,0.1 V	0.041	1.60(2.20)	100
BPSC00070740120□S0	12	30	10 kHz,0.1 V	0.053	1.50(1.90)	120
BPSC00070740150□S0	15	20,30	10 kHz,0.1 V	0.057	1.40(1.80)	150
BPSC00070740180□S0	18	30	10 kHz,0.1 V	0.092	1.25(1.60)	180
BPSC00070740220□S0	22	20,30	10 kHz,0.1 V	0.096	1.10(1.50)	220
BPSC00070740270□S0	27	30	10 kHz,0.1 V	0.109	0.90(1.20)	270
BPSC00070740330□S0	33	20,30	10 kHz,0.1 V	0.124	0.85(1.10)	330
BPSC00070740390□S0	39	20,30	10 kHz,0.1 V	0.138	0.80(1.10)	390
BPSC00070740470□S0	47	20,30	10 kHz,0.1 V	0.15	0.70(1.00)	470
BPSC00070740560□S0	56	30	10 kHz,0.1 V	0.202	0.65(0.90)	560
BPSC00070740680□S0	68	20,30	10 kHz,0.1 V	0.234	0.60(0.80)	680
BPSC00070740820□S0	82	30	10 kHz,0.1 V	0.324	0.55(0.70)	820
BPSC00070740101□S0	100	20,30	10 kHz,0.1 V	0.358	0.50(0.65)	101
BPSC00070740561□S0	560	30	10 kHz,0.1 V	1.8	0.20(0.25)	561

Note: When ordering, please specify tolerance code. Tolerance: M=±20% , T=±30%

- Operating temperature range - 30°C ~ 100°C(Including self - temperature rise)
- Isat for Inductance drop 35% from its value with current
- RDC test method: place testing device to the 2 solder ends of winding and test the value.
- Measure Equipment :
 - L : Agilent/ E4980 or HP4284A
 - RDC : Chroma 16502
 - Isat : HP4284+42841A or WK3260B+WK3265B

Packaging Specifications

Tape Dimensions

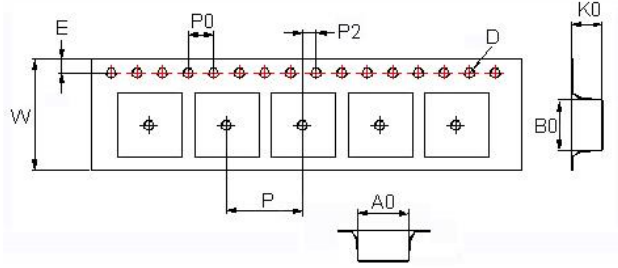

Tape Material

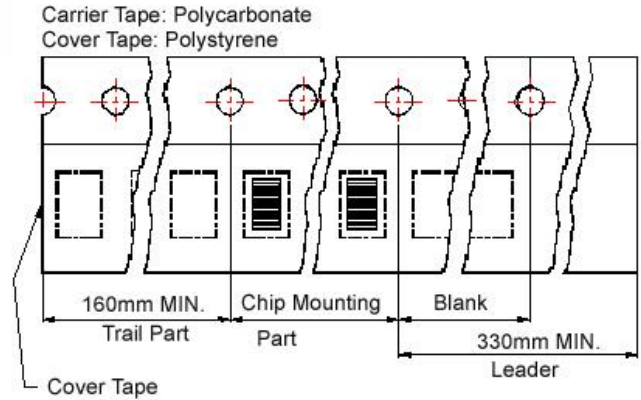

Reel Dimensions

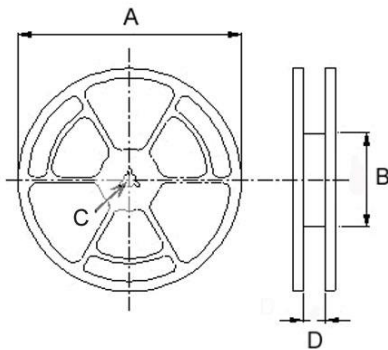

Dimensions in mm

TYPE	Tape Dimensions									Reel Dimensions				Quantity PCS / REEL
	A0	B0	K0	D	E	W	P	P0	P2	A	B	C	D	
BPSC00404018	4.1	4.1	2.0	1.5	1.75	12	8	4	2	178	60	13	13.2	1000
BPSC00050520	5.3	5.3	2.4	1.5	1.75	12	8	4	2	330	100	13	13.4	2000
BPSC00050530	5.3	5.3	3.4	1.5	1.75	12	8	4	2	330	100	13	13.4	2000
BPSC00050540	5.35	5.35	4.1	1.55	1.75	12	8	4	2	330	100	13	13.4	1000
BPSC00060620	6.2	6.2	2.2	1.55	1.75	16	12	4	2	330	100	13	13.4	1500
BPSC00060630	6.2	6.2	3.1	1.55	1.75	16	12	4	2	330	100	13	17.4	1500
BPSC00070730	7.25	7.25	3.35	1.55	1.75	16	12	4	2	330	100	13	17.4	1500
BPSC00070740	7.1	7.1	4.1	1.55	1.75	16	12	4	2	330	100	13	17.4	1000

SMD Shielded Power Inductors

BPSC Series

Features

- RoHS, Halogen Free and REACH Compliance
- Magnetic shielded
- Various package size and wide inductance range

Applications

- AP Routers
- STBs
- LCD TVs and monitors
- Game consoles
- LED lightings
- DC/DC converters

Product Identification

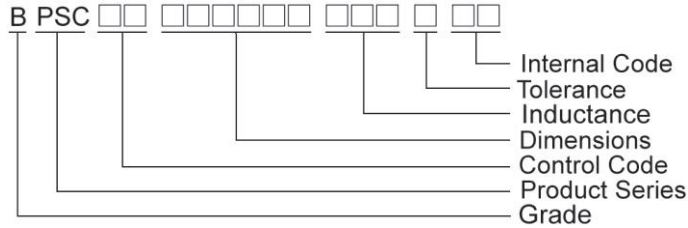

Shape and Dimensions

BPSC00070734/070745

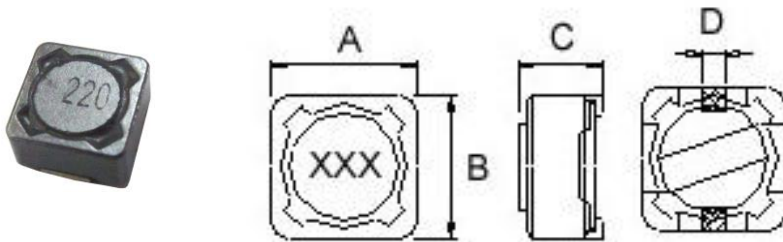

Recommended Pattern

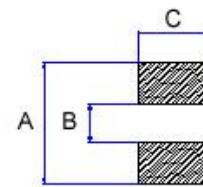

Dimension in mm

TYPE	Shape and Dimensions				Recommended Pattern		
	A	B	C	D	A	B	C
BPSC00070734	7.3±0.2	7.3±0.2	3.4 ⁺⁰	1.8	8.4	4.4	2.2
BPSC00070745	7.3±0.2	7.3±0.2	4.5 ⁺⁰	1.8	8.4	4.4	2.2

Shape and Dimensions

BPSC00101131/101140/101151

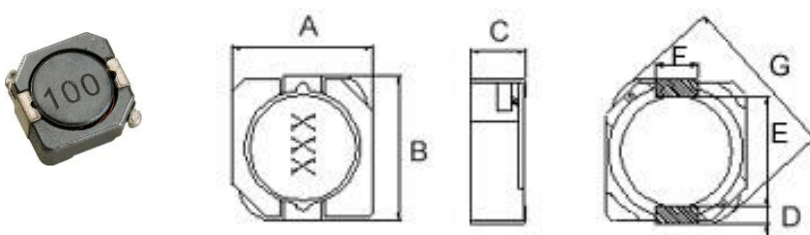

Recommended Pattern

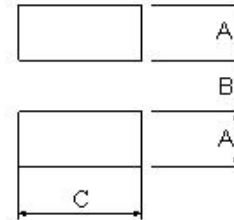

Dimensions in mm

TYPE	A	B	C	D	E	F	G	A	B	C
BPSC00101131	10.3 ⁺⁰	10.5 ⁺⁰	3.1 ⁺⁰	1.2	7.7	3.0	13.5 ⁺⁰	1.6	7.3	3.2
BPSC00101140	10.3 ⁺⁰	10.5 ⁺⁰	4 ⁺⁰	1.2	7.7	3.0	13.5 ⁺⁰	1.6	7.3	3.2
BPSC00101151	10.3 ⁺⁰	10.5 ⁺⁰	5.1 ⁺⁰	1.2	7.7	3.0	13.5 ⁺⁰	1.6	7.3	3.2

Shape and Dimensions

Recommended Pattern

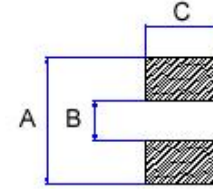
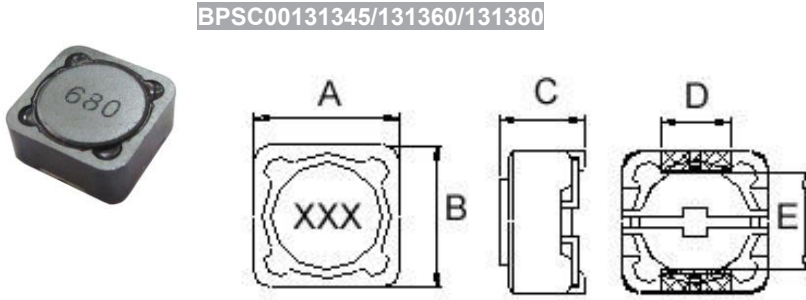

Dimensions in mm

TYPE	Shape and Dimensions					Recommended Pattern		
	A	B	C	D	E	A	B	C
BPSC00131345	12.5 ⁺⁰	12.5 ⁺⁰	4.5 ⁺⁰	5	7.6	13	7	5.4
BPSC00131360	12.5 ⁺⁰	12.5 ⁺⁰	6 ⁺⁰	5	7.6	13	7	5.4
BPSC00131380	12.5 ⁺⁰	12.5 ⁺⁰	8 ⁺⁰	5	7.6	13	7	5.4

Electrical Characteristics

Part Number	Inductance (μ H)	Tolerance (\pm %)	Test Frequency	RDC (Ω) Max	Isat (A) Max	Marking
BPSC000707341R5□00	1.5	20	1 kHz,1 V	0.03	4	1R5
BPSC000707342R2□00	2.2	20	1 kHz,1 V	0.03	4	2R2
BPSC000707343R3□00	3.3	20	1 kHz,1 V	0.04	3.7	3R3
BPSC000707346R8□00	6.8	20	1 kHz,1 V	0.06	2	6R8
BPSC00070734100□00	10	20	1 kHz,1 V	0.072	1.68	100
BPSC00070734120□00	12	20	1 kHz,1 V	0.098	1.52	120
BPSC00070734150□00	15	20	1 kHz,1 V	0.13	1.33	150
BPSC00070734180□00	18	20	1 kHz,1 V	0.14	1.2	180
BPSC00070734220□00	22	20	1 kHz,1 V	0.19	1.07	220
BPSC00070734270□00	27	20	1 kHz,1 V	0.21	0.96	270
BPSC00070734330□00	33	20	1 kHz,1 V	0.24	0.91	330
BPSC00070734390□00	39	20	1 kHz,1 V	0.32	0.77	390
BPSC00070734470□00	47	20	1 kHz,1 V	0.36	0.76	470
BPSC00070734560□00	56	20	1 kHz,1 V	0.47	0.68	560
BPSC00070734680□00	68	20	1 kHz,1 V	0.52	0.61	680
BPSC00070734820□00	82	20	1 kHz,1 V	0.69	0.57	820
BPSC00070734101□00	100	20	1 kHz,1 V	0.79	0.5	101
BPSC00070734121□00	120	20	1 kHz,1 V	0.89	0.49	121
BPSC00070734151□00	150	20	1 kHz,1 V	1.27	0.43	151
BPSC00070734181□00	180	20	1 kHz,1 V	1.45	0.39	181
BPSC00070734221□00	220	20	1 kHz,1 V	1.65	0.35	221
BPSC00070734271□00	270	20	1 kHz,1 V	2.31	0.32	271
BPSC00070734331□00	330	20	1 kHz,1 V	2.62	0.28	331
BPSC00070734391□00	390	20	1 kHz,1 V	2.94	0.26	391
BPSC00070734471□00	470	20	1 kHz,1 V	4.18	0.24	471
BPSC00070734561□00	560	20	1 kHz,1 V	4.67	0.22	561
BPSC00070734681□00	680	20	1 kHz,1 V	5.73	0.19	681
BPSC00070734821□00	820	20	1 kHz,1 V	6.54	0.18	821
BPSC00070734102□00	1000	20	1 kHz,1 V	9.44	0.16	102

Note: When ordering, please specify tolerance code. Tolerance: M=±20%

- Operating temperature range - 40°C ~ 125°C(Including self - temperature rise)
- Isat for Inductance drop 35% from its value with current
- Measure Equipment :
 L : Agilent/ E4980 or HP4284A (under 1MHz), HP4285A (over 1MHz)
 RDC : Chroma 16502
 Isat : HP4284+42841A or WK3260B+WK3265B

Electrical Characteristics

Part Number	Inductance (μ H)	Tolerance (\pm %)	Test Frequency	RDC (Ω) Max	Isat (A) Max	Marking
BPSC000707451R5□00	1.5	20	1 kHz, 1 V	0.02	5	1R5
BPSC000707452R2□00	1.8	20	1 kHz, 1 V	0.025	4	1R8
BPSC000707452R2□00	2.2	20,30	1 kHz, 1 V	0.025	3.5	2R2
BPSC000707452R7□00	2.7	20,30	1 kHz, 1 V	0.03	3.5	2R7
BPSC000707453R3□00	3.3	20,30	1 kHz, 1 V	0.035	3.5	3R3
BPSC000707453R6□00	3.6	20,30	1 kHz, 1 V	0.035	3.2	3R6
BPSC000707454R7□00	4.7	20,30	1 kHz, 1 V	0.035	3	4R7
BPSC000707456R8□00	6.8	20	1 kHz, 1 V	0.045	2.5	6R8
BPSC00070745100□00	10	20	1 kHz, 1 V	0.049	1.84	100
BPSC00070745120□00	12	20	1 kHz, 1 V	0.058	1.71	120
BPSC00070745150□00	15	20	1 kHz, 1 V	0.081	1.47	150
BPSC00070745180□00	18	20	1 kHz, 1 V	0.091	1.31	180
BPSC00070745220□00	22	20	1 kHz, 1 V	0.11	1.23	220
BPSC00070745270□00	27	20	1 kHz, 1 V	0.15	1.12	270
BPSC00070745330□00	33	20	1 kHz, 1 V	0.17	0.96	330
BPSC00070745390□00	39	20	1 kHz, 1 V	0.23	0.91	390
BPSC00070745470□00	47	20	1 kHz, 1 V	0.26	0.88	470
BPSC00070745560□00	56	20	1 kHz, 1 V	0.35	0.75	560
BPSC00070745680□00	68	20	1 kHz, 1 V	0.38	0.69	680
BPSC00070745820□00	82	20	1 kHz, 1 V	0.43	0.61	820
BPSC00070745101□00	100	20	1 kHz, 1 V	0.61	0.6	101
BPSC00070745121□00	120	20	1 kHz, 1 V	0.66	0.52	121
BPSC00070745151□00	150	20	1 kHz, 1 V	0.88	0.46	151
BPSC00070745181□00	180	20	1 kHz, 1 V	0.98	0.42	181
BPSC00070745221□00	220	10,20	1 kHz, 1 V	1.17	0.36	221
BPSC00070745271□00	270	10,20	1 kHz, 1 V	1.64	0.34	271
BPSC00070745331□00	330	10,20	1 kHz, 1 V	1.86	0.32	331
BPSC00070745391□00	390	10,20	1 kHz, 1 V	2.85	0.29	391
BPSC00070745471□00	470	10,20	1 kHz, 1 V	3.01	0.26	471
BPSC00070745561□00	560	10,20	1 kHz, 1 V	3.62	0.23	561

BPSC00070745681□00	680	10,20	1 kHz,1 V	4.63	0.22	681
BPSC00070745821□00	820	10,20	1 kHz,1 V	5.2	0.2	821
BPSC00070745102□00	1000	10,20	1 kHz,1 V	6	0.18	102

Note: When ordering, please specify tolerance code. Tolerance: K=±10% , M=±20% , T=±30%

- Operating temperature range - 40°C ~ 125°C(Including self - temperature rise)
- Isat for Inductance drop 35% from its value with current
- Measure Equipment :
 L : Agilent/ E4980 or HP4284A (under 1MHz), HP4285A (over 1MHz)
 RDC : Chroma 16502
 Isat : HP4284+42841A or WK3260B+WK3265B

Electrical Characteristics

Part Number	Inductance (μH)	Tolerance (±%)	Test Frequency	RDC (Ω) Max	Isat (A) Max	Marking
BPSC001011314R7□00	4.7	30	100 kHz,1 V	0.03	4.65	4R7
BPSC001011316R8□00	6.8	30	100 kHz,1 V	0.035	3.84	6R8
BPSC00101131100□00	10	20,30	100 kHz,1 V	0.059	3.18	100
BPSC00101131150□00	15	20,30	100 kHz,1 V	0.091	2.6	150
BPSC00101131330□00	33	20,30	100 kHz,1 V	0.202	1.74	330
BPSC00101131470□00	47	20,30	100 kHz,1 V	0.299	1.43	470
BPSC00101131560□00	56	20,30	100 kHz,1 V	0.325	0.9	560

Note: When ordering, please specify tolerance code. Tolerance: M=±20% , T=±30%

- Operating temperature range - 40°C ~ 125°C(Including self - temperature rise)
- Isat for Inductance drop 35% from its value with current
- Measure Equipment :
 L : Agilent/ E4980 or HP4284A (under 1MHz), HP4285A (over 1MHz)
 RDC : Chroma 16502
 Isat : HP4284+42841A or WK3260B+WK3265B

Electrical Characteristics

Part Number	Inductance (μ H)	Tolerance (\pm %)	Test Frequency	RDC (Ω) Max	Isat(A) Max(Typ.)	Marking
BPSC001011401R5□00	1.5	30,+40-20	100 kHz,1 V	0.0088	8.5(10.5)	1R5
BPSC001011402R2□00	2.2	30	100 kHz,1 V	0.012	8.0(10.5)	2R2
BPSC001011402R5□00	2.5	30	100 kHz,1 V	0.012	7.5(9.5)	2R5
BPSC001011403R3□00	3.3	30	100 kHz,1 V	0.015	7.0(8.7)	3R3
BPSC001011403R8□00	3.8	30	100 kHz,1 V	0.015	6.8(8.5)	3R8
BPSC001011404R7□00	4.7	20,30	100 kHz,1 V	0.02	5.8(7.3)	4R7
BPSC001011405R2□00	5.2	20,30	100 kHz,1 V	0.024	5.8(7.3)	5R2
BPSC001011405R6□00	5.6	20,30	100 kHz,1 V	0.027	5.0(6.5)	5R6
BPSC001011406R8□00	6.8	20,30	100 kHz,1 V	0.031	5.0(6.5)	6R8
BPSC001011407R0□00	7	20,30	100 kHz,1 V	0.031	4.8(5.9)	7R0
BPSC001011408R2□00	8.2	20,30	100 kHz,1 V	0.036	4.5(5.8)	8R2
BPSC00101140100□00	10	20,30	100 kHz,1 V	0.04	4.0(5.0)	100
BPSC00101140150□00	15	20,30	100 kHz,1 V	0.055	3.4(4.3)	150
BPSC00101140180□00	18	20,30	100 kHz,1 V	0.075	2.9(3.6)	180
BPSC00101140220□00	22	20,30	100 kHz,1 V	0.08	2.6(3.3)	220
BPSC00101140270□00	27	20,30	100 kHz,1 V	0.096	2.4(3.0)	270
BPSC00101140330□00	33	20,30	100 kHz,1 V	0.098	2.3(2.9)	330
BPSC00101140390□00	39	20,30	100 kHz,1 V	0.12	2.1(2.7)	390
BPSC00101140470□00	47	20,30	100 kHz,1 V	0.144	1.8(2.5)	470
BPSC00101140560□00	56	20,30	100 kHz,1 V	0.175	1.6(2.1)	560
BPSC00101140680□00	68	20,30	100 kHz,1 V	0.204	1.4(1.9)	680
BPSC00101140820□00	82	20,30	100 kHz,1 V	0.25	1.3(1.7)	820
BPSC00101140101□00	100	20,30	100 kHz,1 V	0.304	1.0(1.6)	101
BPSC00101140151□00	150	20,30	100 kHz,1 V	0.506	0.96(1.3)	151
BPSC00101140221□00	220	20,30	100 kHz,1 V	0.69	0.8(1.0)	221
BPSC00101140331□00	330	20,30	100 kHz,1 V	1.09	0.68(0.86)	331
BPSC00101140471□00	470	20,30	100 kHz,1 V	1.6	0.6(0.75)	471
BPSC00101140561□00	560	20,30	100 kHz,1 V	1.68	0.5(0.68)	561

Note: When ordering, please specify tolerance code. Tolerance: M=±20% , T=±30% , N=+40% -20%

- Operating temperature range - 40°C ~ 125°C(Including self - temperature rise)
- Isat for Inductance drop 35% from its value with current
- Measure Equipment :
 L : Agilent/ E4980 or HP4284A (under 1MHz), HP4285A (over 1MHz)
 RDC : Chroma 16502
 Isat : HP4284+42841A or WK3260B+WK3265B

Electrical Characteristics

Part Number	Inductance (μ H)	Tolerance (\pm %)	Test Frequency	RDC (Ω) Max	Isat(A) Max(Typ.)	Marking
BPSC00101151R80□00	0.8	30	100 kHz,1 V	0.0062	10.8(13.5)	R80
BPSC001011511R5□00	1.5	30	100 kHz,1 V	0.0081	10.3(12.9)	1R5
BPSC001011512R2□00	2.2	30	100 kHz,1 V	0.011	9.2(11)	2R2
BPSC001011513R3□00	3.3	30	100 kHz,1 V	0.012	7.2(9.0)	3R3
BPSC001011514R7□00	4.7	20,30	100 kHz,1 V	0.014	5.6(7.8)	4R7
BPSC001011516R8□00	6.8	20,30	100 kHz,1 V	0.024	5.1(6.4)	6R8
BPSC001011518R2□00	8.2	20,30	100 kHz,1 V	0.027	4.7(5.9)	8R2
BPSC00101151100□00	10	20,30	100 kHz,1 V	0.028	4.4(5.6)	100
BPSC00101151120□00	12	20,30	100 kHz,1 V	0.036	3.4(5.8)	120
BPSC00101151150□00	15	20,30	100 kHz,1 V	0.041	3.2(4.5)	150
BPSC00101151180□00	18	20,30	100 kHz,1 V	0.046	3.0(3.8)	180
BPSC00101151220□00	22	20,30	100 kHz,1 V	0.061	2.8(3.6)	220
BPSC00101151270□00	27	20,30	100 kHz,1 V	0.069	2.1(3.2)	270
BPSC00101151330□00	33	20,30	100 kHz,1 V	0.084	2.0(2.9)	330
BPSC00101151390□00	39	20,30	100 kHz,1 V	0.106	1.9(2.6)	390
BPSC00101151470□00	47	20,30	100 kHz,1 V	0.13	1.7(2.3)	470
BPSC00101151560□00	56	20,30	100 kHz,1 V	0.149	1.6(2.2)	560
BPSC00101151680□00	68	20,30	100 kHz,1 V	0.201	1.5(2.0)	680
BPSC00101151820□00	82	20,30	100 kHz,1 V	0.227	1.3(1.8)	820
BPSC00101151101□00	100	20,30	100 kHz,1 V	0.253	1.2(1.7)	101
BPSC00101151121□00	120	20,30	100 kHz,1 V	0.303	1.1(1.5)	121
BPSC00101151151□00	150	20,30	100 kHz,1 V	0.42	1.0(1.3)	151
BPSC00101151181□00	180	20,30	100 kHz,1 V	0.45	0.9(1.2)	181
BPSC00101151221□00	220	20,30	100 kHz,1 V	0.54	0.8(1.1)	221
BPSC00101151271□00	270	20,30	100 kHz,1 V	0.672	0.75(0.99)	271
BPSC00101151331□00	330	20,30	100 kHz,1 V	0.812	0.74(0.92)	331
BPSC00101151391□00	390	20,30	100 kHz,1 V	0.953	0.62(0.83)	391
BPSC00101151471□00	470	20,30	100 kHz,1 V	1.29	0.6(0.77)	471
BPSC00101151561□00	560	20,30	100 kHz,1 V	1.43	0.47(0.71)	561
BPSC00101151681□00	680	20,30	100 kHz,1 V	1.6	0.46(0.65)	681

BPSC00101151821□00	820	20,30	100 kHz,1 V	1.77	0.42(0.57)	821
BPSC00101151102□00	1000	20,30	100 kHz,1 V	2.2	0.40(0.54)	102

Note: When ordering, please specify tolerance code. Tolerance: M=±20% , T=±30%

- Operating temperature range - 40°C ~ 125°C(Including self - temperature rise)
- Isat for Inductance drop 35% from its value with current
- Measure Equipment :
 L : Agilent/ E4980 or HP4284A (under 1MHz), HP4285A (over 1MHz)
 RDC : Chroma 16502
 Isat : HP4284+42841A or WK3260B+WK3265B

Electrical Characteristics

Part Number	Inductance (μH)	Tolerance (±%)	Test Frequency	RDC (Ω) Max	Isat(A) Max(Typ.)	Marking
BPSC001313453R3□00	3.3	30	100 kHz,1 V	0.015	8.8(11.1)	3R3
BPSC001313453R9□00	3.9	30	100 kHz,1 V	0.016	8.0(10.1)	3R9
BPSC001313454R7□00	4.7	20,30	100 kHz,1 V	0.018	7.9(9.9)	4R7
BPSC001313456R8□00	6.8	20,30	100 kHz,1 V	0.023	6.5(8.3)	6R8
BPSC00131345100□00	10	20,30	100 kHz,1 V	0.035	5.2(6.6)	100
BPSC00131345120□00	12	20,30	100 kHz,1 V	0.038	4.8(6.2)	120
BPSC00131345150□00	15	20,30	100 kHz,1 V	0.05	4.1(5.4)	150
BPSC00131345180□00	18	20,30	100 kHz,1 V	0.057	4.0(5.1)	180
BPSC00131345220□00	22	20,30	100 kHz,1 V	0.066	3.5(4.4)	220
BPSC00131345270□00	27	20,30	100 kHz,1 V	0.08	3.1(3.9)	270
BPSC00131345330□00	33	20,30	100 kHz,1 V	0.097	2.7(3.5)	330
BPSC00131345390□00	39	20,30	100 kHz,1 V	0.132	2.1(3.2)	390
BPSC00131345470□00	47	20,30	100 kHz,1 V	0.15	1.9(2.9)	470
BPSC00131345560□00	56	20,30	100 kHz,1 V	0.19	1.8(2.6)	560
BPSC00131345680□00	68	20,30	100 kHz,1 V	0.22	1.5(2.5)	680
BPSC00131345820□00	82	20,30	100 kHz,1 V	0.26	1.3(2.3)	820
BPSC00131345101□00	100	20,30	100 kHz,1 V	0.308	1.2(2.0)	101
BPSC00131345121□00	120	20,30	100 kHz,1 V	0.38	1.1(1.8)	121
BPSC00131345151□00	150	20,30	100 kHz,1 V	0.53	0.95(1.6)	151
BPSC00131345181□00	180	20,30	100 kHz,1 V	0.62	0.85(1.4)	181

BPSC00131345221□00	220	20,30	100 kHz,1 V	0.7	0.8(1.3)	221
BPSC00131345271□00	270	20,30	100 kHz,1 V	0.876	0.6(1.1)	271
BPSC00131345331□00	330	20,30	100 kHz,1 V	0.99	0.5(1.0)	331

Note: When ordering, please specify tolerance code. Tolerance: M=±20% , T=±30%

- Operating temperature range - 40°C ~ 125°C(Including self - temperature rise)
- Isat for Inductance drop 35% from its value with current
- Measure Equipment :
 L : Agilent/ E4980 or HP4284A (under 1MHz), HP4285A (over 1MHz)
 RDC : Chroma 16502
 Isat : HP4284+42841A or WK3260B+WK3265B

Electrical Characteristics

Part Number	Inductance (μH)	Tolerance (±%)	Test Frequency	RDC (Ω) Max	Isat(A) Max(Typ.)	Marking
BPSC001313603R3□00	3.3	30	1 kHz,1 V	0.015	8.0(11)	3R3
BPSC001313604R7□00	4.7	20,30	1 kHz,1 V	0.018	7.6(9.2)	4R7
BPSC001313606R4□00	6.4	20,30	1 kHz,1 V	0.018	6.4(8.1)	6R4
BPSC001313608R2□00	8.2	20,30	1 kHz,1 V	0.02	5.8(7.4)	8R2
BPSC00131360100□00	10	20,30	1 kHz,1 V	0.025	5.3(6.8)	100
BPSC00131360120□00	12	20,30	1 kHz,1 V	0.027	5.3(6.8)	120
BPSC00131360150□00	15	20,30	1 kHz,1 V	0.03	4.0(5.2)	150
BPSC00131360180□00	18	20,30	1 kHz,1 V	0.034	3.8(4.9)	180
BPSC00131360220□00	22	20,30	1 kHz,1 V	0.036	3.6(4.8)	220
BPSC00131360270□00	27	20,30	1 kHz,1 V	0.051	3.2(4.1)	270
BPSC00131360330□00	33	20,30	1 kHz,1 V	0.057	2.9(3.7)	330
BPSC00131360390□00	39	20,30	1 kHz,1 V	0.068	2.7(3.5)	390
BPSC00131360470□00	47	20,30	1 kHz,1 V	0.084	2.4(3.1)	470
BPSC00131360560□00	56	20,30	1 kHz,1 V	0.1	2.1(2.7)	560
BPSC00131360680□00	68	20,30	1 kHz,1 V	0.12	2.0(2.6)	680
BPSC00131360820□00	82	20,30	1 kHz,1 V	0.14	1.8(2.3)	820
BPSC00131360101□00	100	20,30	1 kHz,1 V	0.16	1.6(2.1)	101
BPSC00131360121□00	120	20,30	1 kHz,1 V	0.18	1.5(1.9)	121
BPSC00131360151□00	150	20,30	1 kHz,1 V	0.23	1.3(1.7)	151
BPSC00131360181□00	180	20,30	1 kHz,1 V	0.29	1.2(1.6)	181
BPSC00131360221□00	220	20,30	1 kHz,1 V	0.32	1.0(1.4)	221
BPSC00131360271□00	270	20,30	1 kHz,1 V	0.38	0.90(1.2)	271

BPSC00131360331□00	330	20,30	1 kHz,1 V	0.48	0.75(1.1)	331
BPSC00131360391□00	390	20,30	1 kHz,1 V	0.6	0.70(1.0)	391
BPSC00131360471□00	470	20,30	1 kHz,1 V	0.7	0.65(0.99)	471
BPSC00131360561□00	560	20,30	1 kHz,1 V	0.86	0.60(0.91)	561
BPSC00131360681□00	680	20,30	1 kHz,1 V	1.1	0.55(0.82)	681
BPSC00131360821□00	820	20,30	1 kHz,1 V	1.34	0.50(0.71)	821
BPSC00131360102□00	1000	20,30	1 kHz,1 V	1.53	0.45(0.64)	102

Note: When ordering, please specify tolerance code. Tolerance: M=±20% , T=±30%

- Operating temperature range - 40°C ~ 125°C(Including self - temperature rise)
- Isat for Inductance drop 35% from its value with current
- Measure Equipment :
 L : Agilent/ E4980 or HP4284A (under 1MHz), HP4285A (over 1MHz)
 RDC : Chroma 16502
 Isat : HP4284+42841A or WK3260B+WK3265B

Electrical Characteristics

Part Number	Inductance (μH)	Tolerance (±%)	Test Frequency	RDC (Ω) Max	Isat(A) Max(Typ.)	Marking
BPSC001313801R5□00	1.5	30	100 kHz,1 V	0.0074	21.6(28.0)	1R5
BPSC001313802R2□00	2.2	30,+40-20	100 kHz,1 V	0.0089	17.6(24.0)	2R2
BPSC001313802R4□00	2.4	30,+40-20	100 kHz,1 V	0.0089	17.6(24.0)	2R4
BPSC001313803R3□00	3.3	30,+40-20	100 kHz,1 V	0.0099	14.6(19.4)	3R3
BPSC001313803R5□00	3.5	30,+40-20	100 kHz,1 V	0.0123	13.8(17.4)	3R5
BPSC001313804R7□00	4.7	20,30	100 kHz,1 V	0.0158	12.3(15.4)	4R7
BPSC001313806R1□00	6.1	20,30,+40-20	100 kHz,1 V	0.0176	10.9(13.8)	6R1
BPSC001313806R8□00	6.8	20,30	100 kHz,1 V	0.018	10.8(13.7)	6R8
BPSC001313807R6□00	7.6	20,30	100 kHz,1 V	0.02	10.0(12.6)	7R6
BPSC00131380100□00	10	20,30	1 kHz,1 V	0.022	8.9(11.2)	100
BPSC00131380120□00	12	20,30	1 kHz,1 V	0.03	7.4(9.4)	120
BPSC00131380150□00	15	20,30	1 kHz,1 V	0.034	7.1(9.0)	150
BPSC00131380180□00	18	20,30	1 kHz,1 V	0.0392	6.5(8.2)	180
BPSC00131380220□00	22	20,30	1 kHz,1 V	0.048	5.8(7.5)	220
BPSC00131380270□00	27	20,30	1 kHz,1 V	0.052	5.3(6.7)	270
BPSC00131380330□00	33	20,30	1 kHz,1 V	0.0648	4.8(6.1)	330
BPSC00131380390□00	39	20,30	1 kHz,1 V	0.065	3.9(5.6)	390
BPSC00131380470□00	47	20,30	1 kHz,1 V	0.1	3.6(5.2)	470

SMD Shielded Power Inductors

BPSC Series



BPSC00131380560□00	56	20,30	1 kHz,1 V	0.11	3.4(4.8)	560
BPSC00131380680□00	68	20,30	1 kHz,1 V	0.12	2.8(4.1)	680
BPSC00131380820□00	82	20,30	1 kHz,1 V	0.16	2.7(4.0)	820
BPSC00131380101□00	100	20,30	1 kHz,1 V	0.17	2.5(3.5)	101
BPSC00131380121□00	120	20,30	1 kHz,1 V	0.19	2.2(3.2)	121
BPSC00131380151□00	150	20,30	1 kHz,1 V	0.25	2.0(2.9)	151
BPSC00131380181□00	180	20,30	1 kHz,1 V	0.31	1.8(2.6)	181
BPSC00131380221□00	220	20,30	1 kHz,1 V	0.35	1.7(2.4)	221
BPSC00131380271□00	270	20,30	1 kHz,1 V	0.43	1.5(2.2)	271
BPSC00131380331□00	330	20,30	1 kHz,1 V	0.51	1.2(2.0)	331
BPSC00131380391□00	390	20,30	1 kHz,1 V	0.6	1.1(1.6)	391
BPSC00131380471□00	470	20,30	1 kHz,1 V	0.71	0.99(1.6)	471
BPSC00131380561□00	560	20,30	1 kHz,1 V	0.88	0.95(1.4)	561
BPSC00131380681□00	680	20,30	1 kHz,1 V	1.04	0.84(1.2)	681
BPSC00131380821□00	820	20,30	1 kHz,1 V	1.36	0.77(1.1)	821
BPSC00131380102□00	1000	20,30	1 kHz,1 V	1.66	0.73(1.0)	102

Note: When ordering, please specify tolerance code. Tolerance: M=±20% , T=±30% , N=+40% -20%

- Operating temperature range - 40°C ~ 125°C(Including self - temperature rise)
- Isat for Inductance drop 35% from its value with current
- Measure Equipment :
 L : Agilent/ E4980 or HP4284A (under 1MHz), HP4285A (over 1MHz)
 RDC : Chroma 16502
 Isat : HP4284+42841A or WK3260B+WK3265B

Curves of BPSC Series

Test Instruments : HP4294 Impedance / Material Analyzer

BPSC00070734

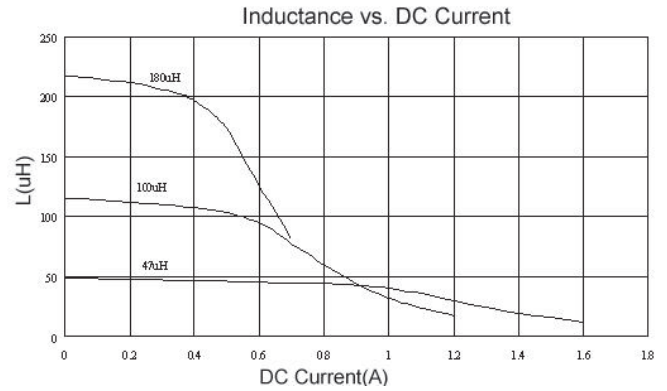
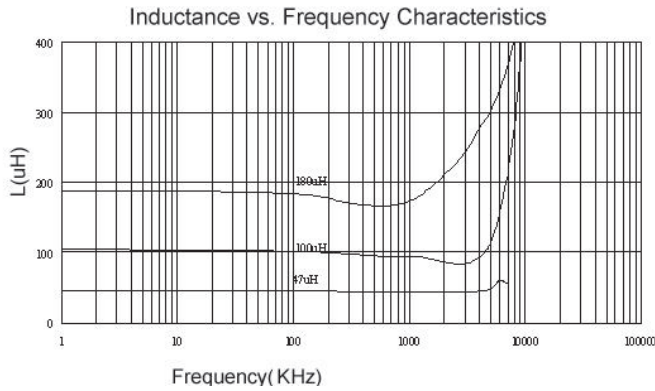

BPSC00070745

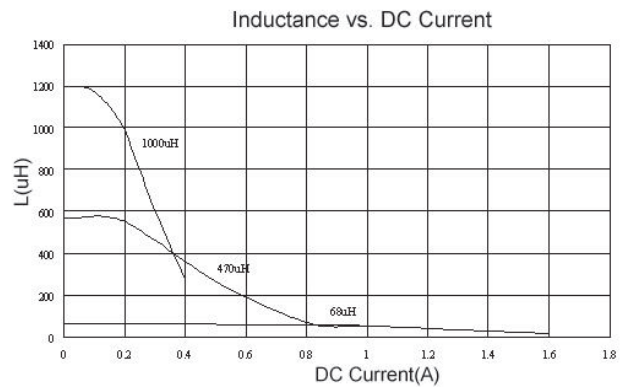
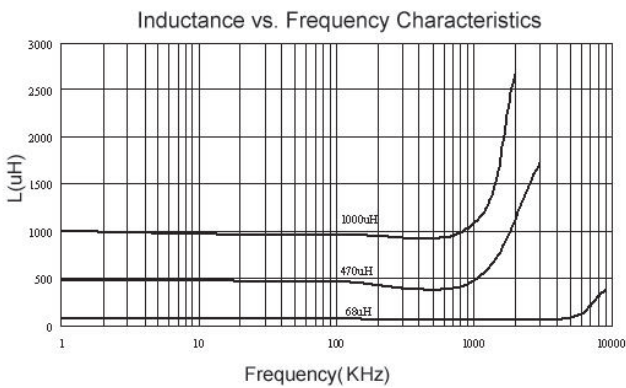

BPSC00101140

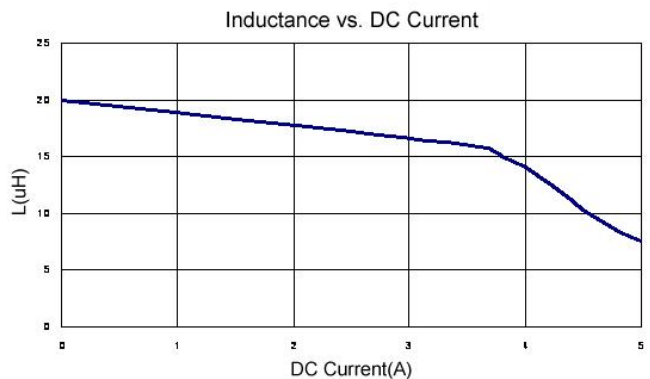
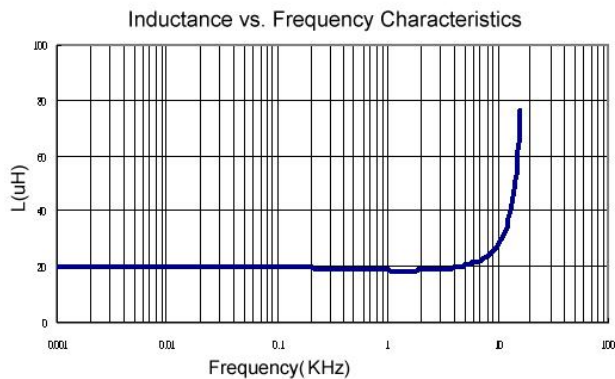

BPSC00131345

Inductance vs. Frequency Characteristics

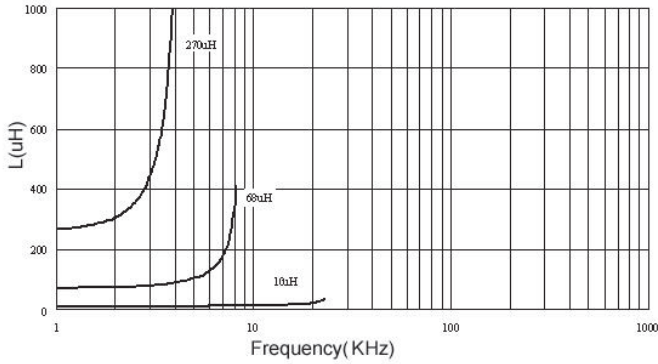

Inductance vs. DC Current

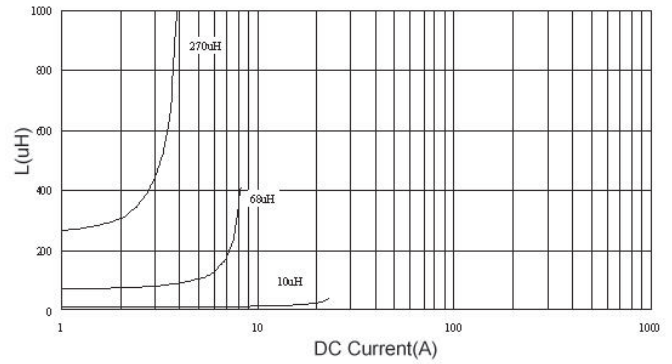

BPSC00131360

Inductance vs. Frequency Characteristics

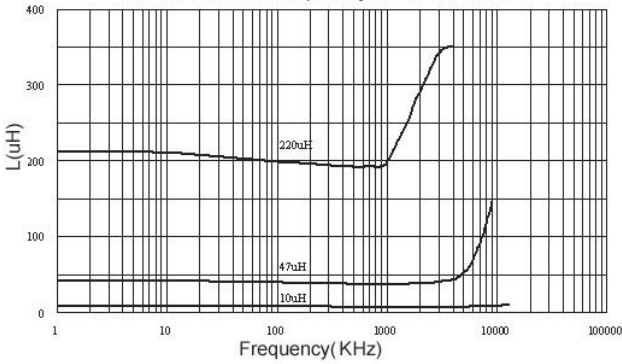

Inductance vs. DC Current

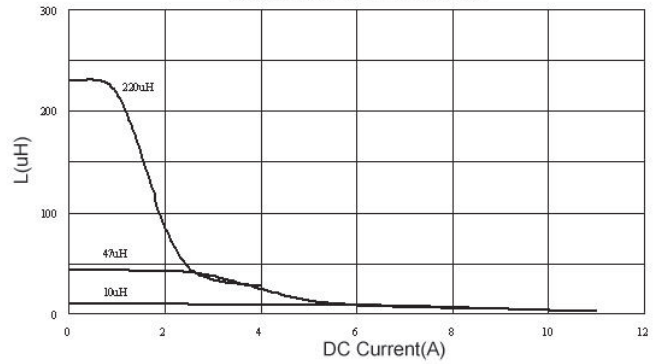

BPSC00131380

Inductance vs. Frequency Characteristics

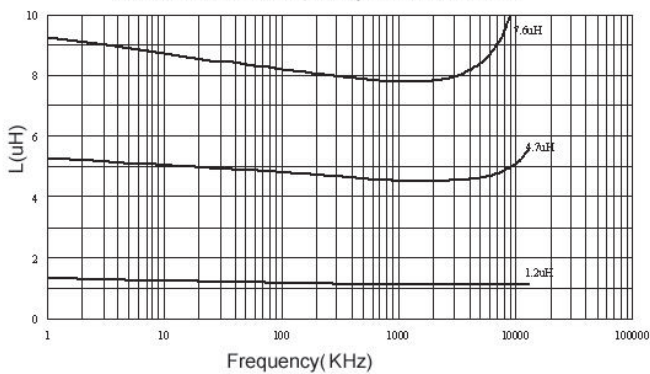

Inductance vs. DC Current

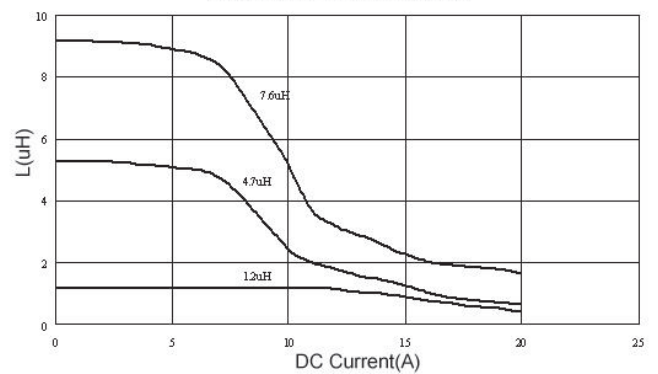

Packaging Specifications

Tape Dimensions

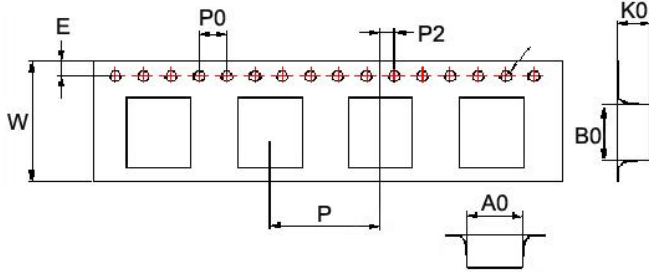

Tape Material

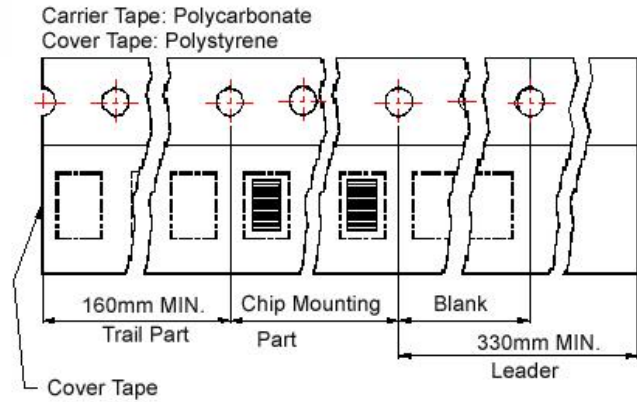

Reel Dimensions

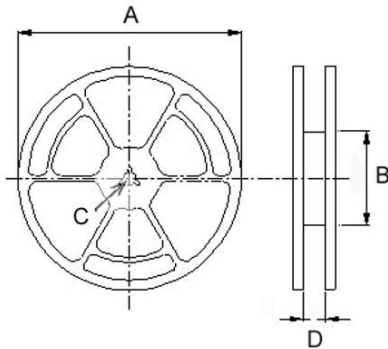

Dimensions in mm

TYPE	Tape Dimensions									Reel Dimensions				Quantity PCS / REEL
	A0	B0	K0	D	E	W	P	P0	P2	A	B	C	D	
BPSC00070734	7.6	7.6	3.6	1.55	1.75	16	12	4	2	330	100	13	16.0	1600
BPSC00070745	7.6	7.6	5.0	1.55	1.75	16	12	4	2	330	100	13	16.0	1000
BPSC00101131	10.6	10.75	4.2	1.55	1.75	24	16	4	2	300	100	13	24.4	1000
BPSC00101140	10.6	10.75	4.2	1.5	1.75	24	16	4	2	330	100	13	24.4	1000
BPSC00101151	10.6	10.6	5.0	1.5	1.75	24	16	4	2	330	100	13	24.4	500
BPSC00131345	13.0	12.8	5.1	1.55	1.75	24	16	4	2	330	100	13	24.4	500
BPSC00131360	12.6	12.6	6.7	1.55	1.75	24	16	4	2	330	100	13	24.4	600
BPSC00131380	12.6	12.6	8.7	1.55	1.75	24	16	4	2	330	100	13	24.4	500

SMD Shielded Power Inductors

BPSC Series



Features

- RoHS, Halogen Free and REACH Compliance
- Magnetic shielded
- Various package size and wide inductance range

Applications

- AP Routers
- STBs
- LCD TVs and monitors
- Game consoles
- LED lightings
- DC/DC converters

Product Identification

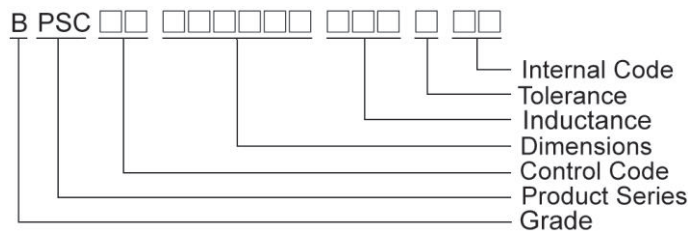

Shapes and Dimensions

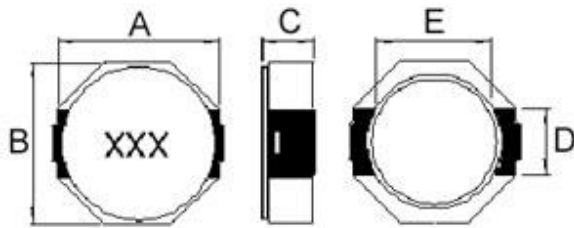

Recommended Pattern

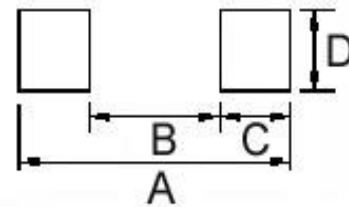

Dimension in mm

TYPE	A	B	C	D	E
BPSC00080845	8.3 ⁺⁰	8.3 ⁺⁰	4.5 ⁺⁰	2.5	6.3

Dimension in mm

TYPE	A	B	C	D
BPSC00080845	10.1	6.1	2.0	2.8

Electrical Characteristics

Part Number	Inductance (μ H)	Tolerance (\pm %)	Test Frequency (kHz)	RDC ($m\Omega$) Max	Rated Current (A)	Marking
BPSC000808453R3□00	3.3	20	100	19	5.7	3R3
BPSC000808454R7□00	4.7	20	100	22	5.6	4R7
BPSC000808456R8□00	6.8	20	100	25	4.4	6R8
BPSC00080845100□00	10	20	100	36	4.0	100
BPSC00080845150□00	15	20	100	53	2.9	150
BPSC00080845220□00	22	20	100	75	2.4	220
BPSC00080845470□00	47	20	100	150	1.8	470
BPSC00080845680□00	68	20	100	240	1.5	680
BPSC00080845101□00	100	20	100	353	1.1	101

Note: When ordering, please specify tolerance code. Tolerance: M= \pm 20%

- Operating temperature range - 30°C ~ 100°C(Including self - temperature rise)
- Rated current for Inductance drop 35% from its value with current
- Measure Equipment :
L : HP4284A 100kHz/1V
RDC : Chroma 16502
Rated current : HP4284+42841A

Packaging Specifications

Tape Dimensions

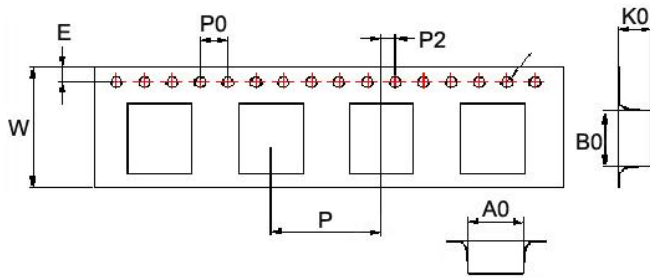

Tape Material

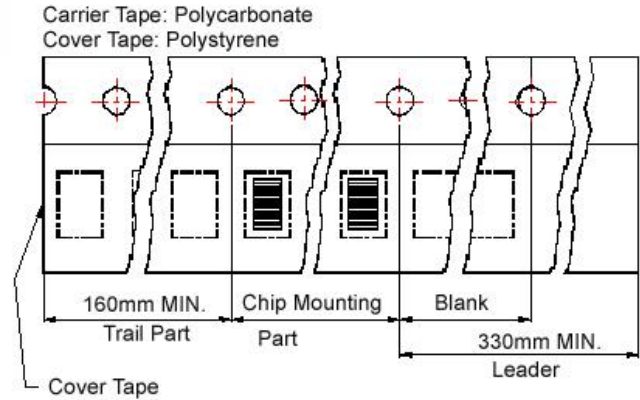

Reel Dimensions

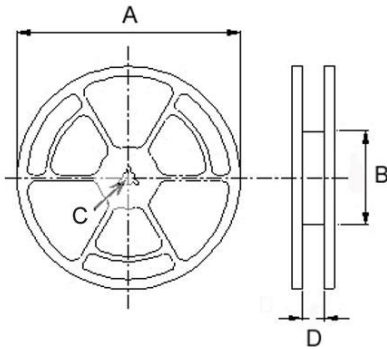

Dimensions in mm

TYPE	Tape Dimensions									Reel Dimensions				Quantity
	A0	B0	K0	D	E	W	P	P0	P2	A	B	C	D	PCS / REEL
BPSC00080845	8.4	9.9	4.8	1.55	1.75	24	12	4	2	330	100	13	24.4	1000

For More Information:

Americas - proinfo_power_americas@yageo.com | Europe - proinfo_power_emea@yageo.com | Asia - proinfo_power_asia@yageo.com

Performance warranty of products offered on this data sheet is limited to the parameters specified. Data is subject to change without notice. Other brand and product names mentioned herein may be trademarks or registered trademarks of their respective owners. © Copyright, 2022. Pulse Electronics, Inc. All rights reserved.

Looking for pricing, stock, or lifecycle information?

Click below to explore more details on WIN SOURCE:

 [View BPSC00070740101MS0 on WIN SOURCE](#)

 [Chilisin Information](#)

Optimize Your Supply Chain with WIN SOURCE Solutions

-  Global Sourcing Solution
-  Obsolete Management
-  Cost Control Management
-  Shortage Management
-  Alternative Solution
-  Excess Inventory Management