



**THE DATASHEET OF
CMD5H-4E TR PBFREE**



CMDSH-4E

**ENHANCED SPECIFICATION
SURFACE MOUNT SILICON
SCHOTTKY DIODE**



www.centrasemi.com

DESCRIPTION:

The CENTRAL SEMICONDUCTOR CMDSH-4E is an enhanced version of the CMDSH-3 silicon Schottky diode in an SOD-323 surface mount package.

ENHANCED SPECIFICATIONS:

- ◆ I_O from 100mA MAX to 200mA MAX
- ◆ BV_R from 30V MIN to 40V MIN
- ◆ V_F from 1.0V MAX to 0.8V MAX

MARKING CODE: S1E

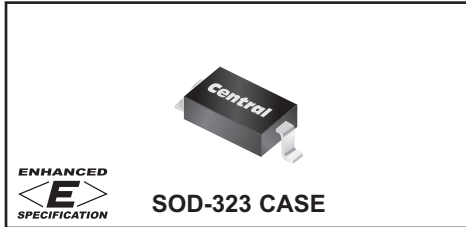

MAXIMUM RATINGS: ($T_A=25^\circ\text{C}$)

- ◆ **Peak Repetitive Reverse Voltage**
- ◆ **Average Forward Current**
Peak Repetitive Forward Current
Peak Forward Surge Current, $t_p=10\text{ms}$
Power Dissipation
Operating and Storage Junction Temperature
Thermal Resistance

SYMBOL		UNITS
V_{RRM}	40	V
I_O	200	mA
I_{FRM}	350	mA
I_{FSM}	750	mA
P_D	250	mW
T_J, T_{stg}	-65 to +150	$^\circ\text{C}$
θ_{JA}	500	$^\circ\text{C/W}$

ELECTRICAL CHARACTERISTICS: ($T_A=25^\circ\text{C}$ unless otherwise noted)

SYMBOL	TEST CONDITIONS	MIN	TYP	MAX	UNITS
I_R	$V_R=25\text{V}$		90	500	nA
I_R	$V_R=25\text{V}, T_A=100^\circ\text{C}$		25	100	μA
◆ BV_R	$I_R=100\mu\text{A}$	40	50		V
V_F	$I_F=2.0\text{mA}$		0.29	0.33	V
◆ V_F	$I_F=15\text{mA}$		0.37	0.42	V
◆ V_F	$I_F=100\text{mA}$		0.51	0.80	V
◆◆ V_F	$I_F=200\text{mA}$		0.65	1.0	V
C_J	$V_R=1.0\text{V}, f=1.0\text{MHz}$		7.0		pF
t_{rr}	$I_F=I_R=10\text{mA}, I_{rr}=1.0\text{mA}, R_L=100\Omega$			5.0	ns

- ◆ Enhanced specification.
- ◆◆ Additional Enhanced specification.

CMDSH-4E

**ENHANCED SPECIFICATION
SURFACE MOUNT SILICON
SCHOTTKY DIODE**



SOD-323 CASE - MECHANICAL OUTLINE

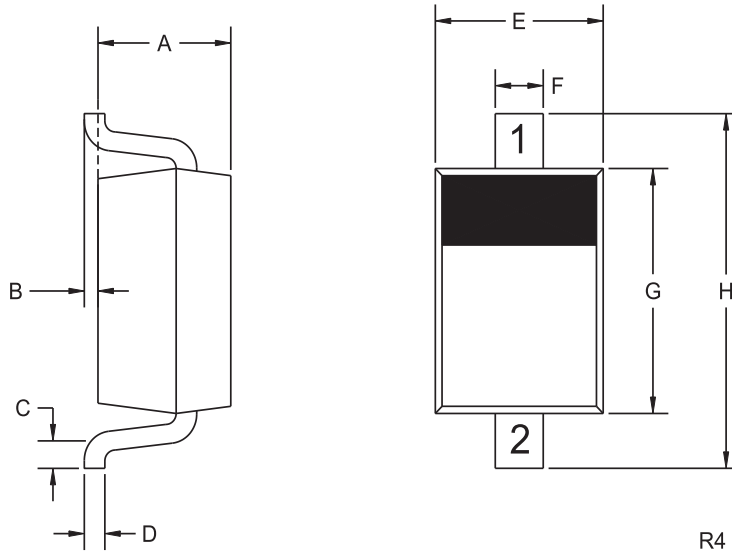

LEAD CODE:

- 1) Cathode
- 2) Anode

MARKING CODE: S1E

DIMENSIONS				
SYMBOL	INCHES		MILLIMETERS	
	MIN	MAX	MIN	MAX
A	0.031	0.039	0.80	1.00
B	0.000	0.004	0.00	0.10
C	0.008	-	0.20	-
D	0.004	0.007	0.11	0.19
E	0.045	0.053	1.15	1.35
F	-	0.014	-	0.35
G	0.063	0.071	1.60	1.80
H	0.094	0.102	2.40	2.60

SOD-323 (REV: R4)

R3 (11-February 2016)

CMDSH-4E

**ENHANCED SPECIFICATION
SURFACE MOUNT SILICON
SCHOTTKY DIODE**



TYPICAL ELECTRICAL CHARACTERISTICS

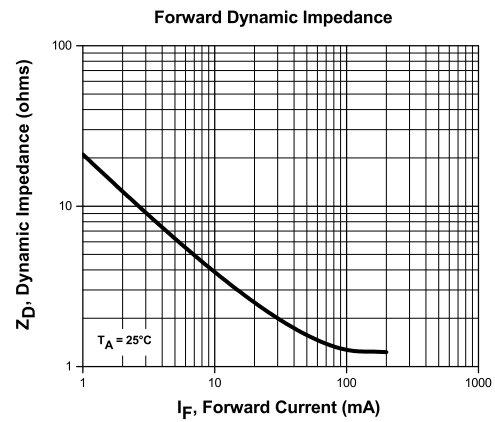
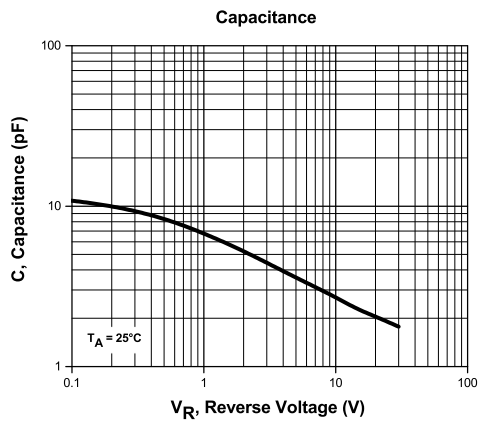
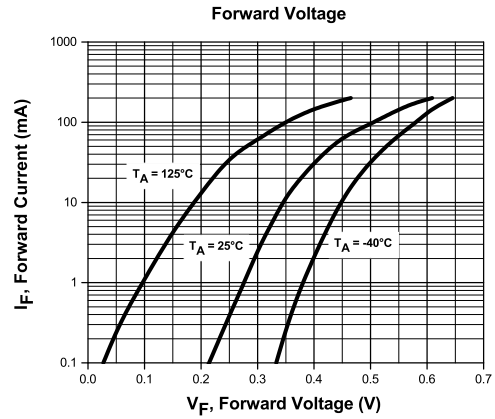
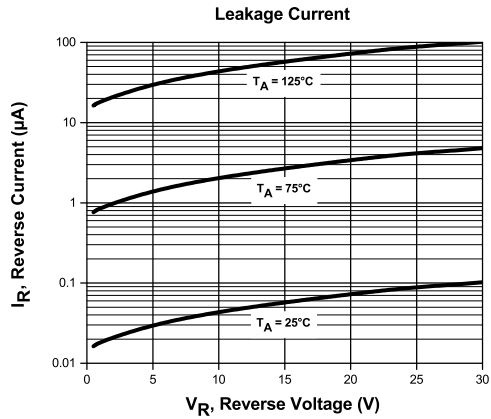

R3 (11-February 2016)

CMDSH-4E

**ENHANCED SPECIFICATION
SURFACE MOUNT SILICON
SCHOTTKY DIODE**



TYPICAL ELECTRICAL CHARACTERISTICS

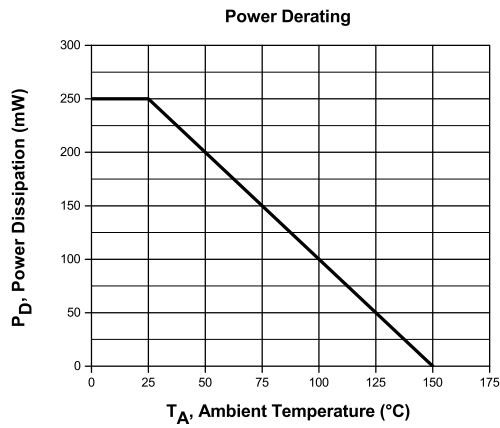
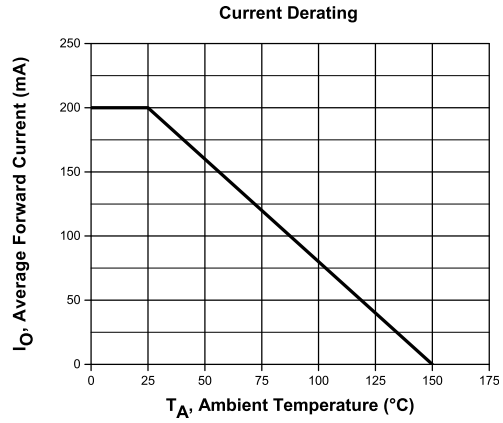
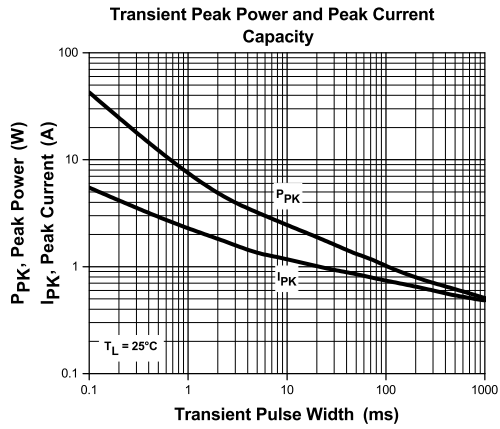

R3 (11-February 2016)

OUTSTANDING SUPPORT AND SUPERIOR SERVICES



PRODUCT SUPPORT

Central's operations team provides the highest level of support to insure product is delivered on-time.

- Supply management (Customer portals)
- Inventory bonding
- Consolidated shipping options
- Custom bar coding for shipments
- Custom product packing

DESIGNER SUPPORT/SERVICES

Central's applications engineering team is ready to discuss your design challenges. Just ask.

- Free quick ship samples (2nd day air)
- Online technical data and parametric search
- SPICE models
- Custom electrical curves
- Environmental regulation compliance
- Customer specific screening
- Up-screening capabilities
- Special wafer diffusions
- PbSn plating options
- Package details
- Application notes
- Application and design sample kits
- Custom product and package development

REQUESTING PRODUCT PLATING

1. If requesting Tin/Lead plated devices, add the suffix "TIN/LEAD" to the part number when ordering (example: 2N2222A TIN/LEAD).
2. If requesting Lead (Pb) Free plated devices, add the suffix "PBFREE" to the part number when ordering (example: 2N2222A PBFREE).

CONTACT US

Corporate Headquarters & Customer Support Team

Central Semiconductor Corp.
145 Adams Avenue
Hauppauge, NY 11788 USA
Main Tel: (631) 435-1110
Main Fax: (631) 435-1824
Support Team Fax: (631) 435-3388
www.centrasemi.com

Worldwide Field Representatives:
www.centrasemi.com/wwreps

Worldwide Distributors:
www.centrasemi.com/wwdistributors

For the latest version of Central Semiconductor's **LIMITATIONS AND DAMAGES DISCLAIMER**, which is part of Central's Standard Terms and Conditions of sale, visit: www.centrasemi.com/terms

Looking for pricing, stock, or lifecycle information?

Click below to explore more details on WIN SOURCE:

- ⊖ [View CMDSH-4E TR PBFREE on WIN SOURCE](#)
- ⊖ [Central Semiconductor Corp Information](#)

Optimize Your Supply Chain with WIN SOURCE Solutions

- ✓ Global Sourcing Solution
- ✓ Obsolete Management
- ✓ Cost Control Management
- ✓ Shortage Management
- ✓ Alternative Solution
- ✓ Excess Inventory Management