



**THE DATASHEET OF
AISC-1008-R018J-T**



SMD Wire-Wound Chip Inductor (Ceramic or Ferrite Core)



AISC-1008(F) SERIES



2.92 x 2.79 x 2.29mm
RoHS/RoHS II Compliant
MSL = MSL - 1

FEATURES

- Ceramic construction assures the utmost thermal stability & high SRF
- Exceptionally high Q compared to non-wirewound inductors, especially at high frequencies
- Inductance options from 4.7nH to 8200nH

APPLICATIONS

- Widely applied in VCO, SAW circuit for GSM, & CDMA communications
- Used in hard disk, notebook computers & other electronic equipment

Electrical Specifications

Part Number AISC-1008- Inductance Code	Inductance	Tolerance	Min. Quality Factor	L/Q Test Freq.	Max. DC Resistance	Max. Rated Current	Min. Self-resonant Frequency
Units	nH	-	-	MHz	Ω	mA	MHz
Symbol	L	-	Q	Freq.	DCR	Ir	S.R.F
AISC-1008-R0047	4.7	J, K, M	50	50/1500	0.11	1000	>6000
AISC-1008-R010	10	G, J, K, M	50	50/500	0.08	1000	4100
AISC-1008-R012	12	G, J, K, M	50	50/500	0.09	1000	3300
AISC-1008-R015	15	G, J, K, M	50	50/500	0.13	1000	2500
AISC-1008-R018	18	G, J, K, M	50	50/350	0.11	1000	2500
AISC-1008-R022	22	G, J, K, M	55	50/350	0.12	1000	2400
AISC-1008-R027	27	G, J, K, M	55	50/350	0.13	1000	1600
AISC-1008-R033	33	G, J, K, M	60	50/350	0.14	1000	1600
AISC-1008-R039	39	G, J, K, M	50	50/350	0.15	1000	1500
AISC-1008-R047	47	G, J, K, M	65	50/350	0.16	1000	1500
AISC-1008-R056	56	G, J, K, M	50	50/350	0.18	1000	1300
AISC-1008-R068	68	G, J, K, M	65	50/350	0.21	1000	1200
AISC-1008-R082	82	G, J, K, M	60	50/350	0.22	1000	800
AISC-1008-R10	100	G, J, K, M	60	25/350	0.56	650	1000
AISC-1008-R12	120	G, J, K, M	60	25/350	0.63	650	950
AISC-1008-R15	150	G, J, K, M	50	25/100	0.62	580	800
AISC-1008-R18	180	G, J, K, M	50	25/100	0.7	620	750
AISC-1008-R22	220	G, J, K, M	50	25/100	0.8	500	630
AISC-1008-R27	270	G, J, K, M	50	25/100	0.91	500	600
AISC-1008-R33	330	G, J, K, M	50	25/100	1.05	450	530
AISC-1008-R39	390	G, J, K, M	50	25/100	1.12	470	480



5101 Hidden Creek Ln Spicewood TX 78669
Phone: 512-371-6159 | Fax: 512-351-8858
For terms and conditions of sales, please visit:
www.abracon.com

REVISED: 09.05.2018

ABRACON IS
ISO9001-2015
CERTIFIED

SMD Wire-Wound Chip Inductor (Ceramic or Ferrite Core)



AISC-1008(F) SERIES



2.92 x 2.79 x 2.29mm
RoHS/RoHS II Compliant
MSL = MSL - 1

Electrical Specifications

Part Number AISC-1008- Inductance Code	Inductance	Tolerance	Min. Quality Factor	L/Q Test Freq.	Max. DC Resistance	Max. Rated Current	Min. Self-resonant Frequency
Units	nH	-	-	MHz	Ω	mA	MHz
Symbol	L	-	Q	Freq.	DCR	Ir	S.R.F
AISC-1008-R47	470	G, J, K, M	50	25/100	1.19	470	450
AISC-1008-R56	560	G, J, K, M	50	25/100	1.33	400	390
AISC-1008-R62	620	G, J, K, M	45	25/100	1.4	300	375
AISC-1008-R68	680	G, J, K, M	45	25/100	1.47	400	360
AISC-1008-R75	750	G, J, K, M	45	25/100	1.54	360	360
AISC-1008-R82	820	G, J, K, M	45	25/100	1.61	400	330
AISC-1008-R91	910	G, J, K, M	35	25/50	1.68	380	295
AISC-1008-1R0	1,000	G, J, K, M	35	25/50	1.8	370	270
AISC-1008-1R2	1,200	G, J, K, M	35	7.9/50	2	310	200
AISC-1008-1R5	1,500	G, J, K, M	28	7.9/50	2.3	330	150
AISC-1008-1R8	1,800	G, J, K, M	28	7.9/50	2.6	300	120
AISC-1008-2R2	2,200	G, J, K, M	28	7.9/50	2.8	280	100
AISC-1008-1R7	2,700	G, J, K, M	22	7.9/25	3.2	290	90
AISC-1008-3R3	3,300	G, J, K, M	22	7.9/25	3.4	290	70
AISC-1008-3R9	3,900	G, J, K, M	17	7.9/25	3.6	260	60
AISC-1008-4R7	4,700	G, J, K, M	20	7.9/25	4	260	50
AISC-1008-5R6	5,600	G, J, K, M	20	7.9/25	5.7	240	40
AISC-1008-6R8	6,800	G, J, K, M	20	7.9/25	7.7	200	40
AISC-1008-8R2	8,200	G, J, K, M	20	7.9/25	10.7	150	30
AISC-1008F-R33	330	J, K, M	50	25/100	0.17	700	600
AISC-1008F-1R0	1,000	J, K, M	20	7.9/50	0.80	600	250
AISC-1008F-1R2	1,200	J, K, M	37	7.9/50	0.80	650	250
AISC-1008F-1R5	1,500	J, K, M	35	7.9/50	0.76	630	190
AISC-1008F-1R8	1,800	J, K, M	33	7.9/50	0.84	600	170
AISC-1008F-2R2	2,200	J, K, M	30	7.9/50	1.15	520	150
AISC-1008F-2R7	2,700	J, K, M	25	7.9/50	1.30	490	120
AISC-1008F-3R3	3,300	J, K, M	23	7.9/50	1.70	450	100
AISC-1008F-3R9	3,900	J, K, M	26	7.9/25	2.00	420	100
AISC-1008F-4R7	4,700	J, K, M	31	7.9/7.9	1.68	400	60
AISC-1008F-5R6	5,600	J, K, M	23	7.9/7.9	2.65	380	80
AISC-1008F-6R8	6,800	J, K, M	20	7.9/7.9	3.00	360	60
AISC-1008F-8R2	8,200	J, K, M	20	7.9/7.9	3.30	330	40
AISC-1008F-100	10,000	J, K, M	15	7.9/7.9	2.95	300	40

REVISED: 09.05.2018



5101 Hidden Creek Ln Spicewood TX 78669
Phone: 512-371-6159 | Fax: 512-351-8858
For terms and conditions of sales, please visit:
www.abracon.com

ABRACON IS
ISO9001-2015
CERTIFIED

SMD Wire-Wound Chip Inductor (Ceramic or Ferrite Core)



AISC-1008(F) SERIES



2.92 x 2.79 x 2.29mm
 RoHS/RoHS II Compliant
 MSL = MSL - 1

Operating Temperature: -40°C to +125°C for AISC-1008, -40°C to +85°C for AISC-1008F

Storage Temperature: -10°C to +40°C, 70% RH max.

Rated Current (Ir): Ir is direct electric current as chip surface temperature rose just 20°C against chip initial surface temperature (Ta)

Electrical Characteristics Curves



SMD Wire-Wound Chip Inductor (Ceramic or Ferrite Core)



AISC-1008(F) SERIES



2.92 x 2.79 x 2.29mm
RoHS/RoHS II Compliant
MSL = MSL - 1

Part Number Identification



Marking: No Marking

SMD Wire-Wound Chip Inductor (Ceramic or Ferrite Core)



AISC-1008(F) SERIES



2.92 x 2.79 x 2.29mm
 RoHS/RoHS II Compliant
 MSL = MSL - 1

Mechanical Dimensions



A MAX.	B MAX.	C MAX.	D REF.	E	F	H REF.	I REF.	J REF.
2.92	2.79	2.29	0.51	2.1±0.2	0.5±0.2	2.54	1.02	1.27

Dimensions: mm



5101 Hidden Creek Ln Spicewood TX 78669
 Phone: 512-371-6159 | Fax: 512-351-8858
 For terms and conditions of sales, please visit:
www.abracon.com

REVISED: 09.05.2018

ABRACON IS
 ISO9001-2015
 CERTIFIED

SMD Wire-Wound Chip Inductor (Ceramic or Ferrite Core)



AISC-1008(F) SERIES



2.92 x 2.79 x 2.29mm
 RoHS/RoHS II Compliant
 MSL = MSL - 1

Materials



No	Components	Material
A	Coating	Ultraviolet epoxy resin
B	Core	Ceramic
C	Wire	Polyurethane system enameled copper wire
D	Electrodes	AISC-1008: Mo-Mn with Ni and Au plating AISC-1008F: Ag-Pd with Ni-Sn plating

Reflow Profile



Zone	Description	Temperature	Times
1	Preheat	$T_{SMIN} \sim T_{SMAX}$ 150°C ~ 200°C	60 ~ 120 sec.
2	Reflow	T_L 217°C	60 ~ 90 sec.
3	Peak heat	T_p 260°C	10 sec. MAX

SMD Wire-Wound Chip Inductor (Ceramic or Ferrite Core)



AISC-1008(F) SERIES



2.92 x 2.79 x 2.29mm
 RoHS/RoHS II Compliant
 MSL = MSL - 1

Packing

T= tape and reel (2,000pcs/reel)



A	P	B	K Max	T
2.73 ± 0.2	4.0 ± 0.1	2.90 ± 0.2	2.34 ± 0.2	0.23 ± 0.1

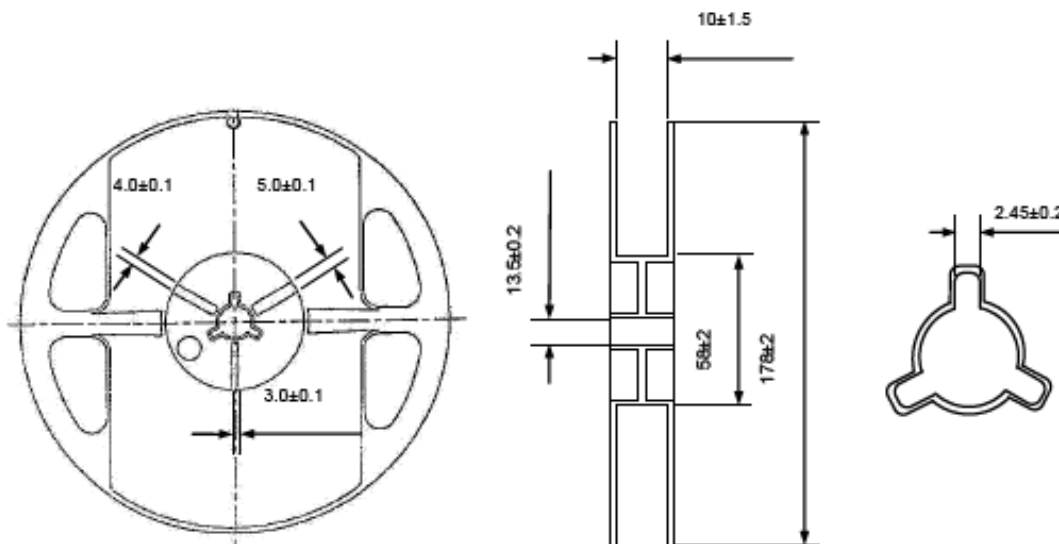

Dimensions: mm



5101 Hidden Creek Ln Spicewood TX 78669
 Phone: 512-371-6159 | Fax: 512-351-8858
 For terms and conditions of sales, please visit:
www.abracon.com

REVISED: 09.05.2018

ABRACON IS
 ISO9001-2015
 CERTIFIED

Looking for pricing, stock, or lifecycle information?

Click below to explore more details on WIN SOURCE:

 [View AISC-1008-R018J-T on WIN SOURCE](#)

 [Abracon LLC Information](#)

Optimize Your Supply Chain with WIN SOURCE Solutions

-  Global Sourcing Solution
-  Obsolete Management
-  Cost Control Management
-  Shortage Management
-  Alternative Solution
-  Excess Inventory Management