

NCP690, NCP691, NCP692, NCV8690

1 A, I_{GND}, Very Low Dropout Voltage Regulator (VLDO), with/without Enable

The NCP690, NCP691, NCP692, NCV8690 CMOS LDO family provides 1 A of output current with enhanced ESD in either fixed voltage options or an adjustable output voltage from 5.0 V down to 1.25 V. This device is designed for space constrained and portable battery powered applications and offer additional features such as high PSRR, low Quiescent and Ground current consumption, low noise operation, short circuit and thermal protection. The device is designed to be used with low cost ceramic capacitors and is packaged in the 6-Lead DFN3x3 package.

Features

- Output Voltage Options: Adjustable, 1.5 V, 1.8 V, 2.5 V, 3.3 V, 5.0 V – Other Options Possible
- Adjustable Output by External Resistors from 5.0 V down to 1.25 V
- Guaranteed 1 A Output Current
- $\pm 1.5\%$ Output Voltage Tolerance over All Operating Conditions (Adjustable)
- $\pm 2\%$ Output Voltage Tolerance over All Operating Conditions (Fixed)
- Typical Noise Voltage of 50 μ V_{rms} without a Bypass Capacitor
- Typical Dropout Voltage of 190 mV at 1 A ($V_{out} = 2.5$ V, $T_J = 25^\circ$ C)
- Active Output Discharge
- Active Low Enable Pin (NCP691 Device)
- Active High Enable Pin (NCP692 device)
- Enhanced ESD: 4 kV and 200 V
- NCV Prefix for Automotive and Other Applications Requiring Unique Site and Control Change Requirements; AEC-Q100 Qualified and PPAP Capable
- These are Pb-Free Devices

Applications

- Laptops and PCI Cards
- Modem Banks and Telecom Boards
- DSP, FPGA, Microprocessor Boards
- Portable, Battery-Power Applications
- Hard Disk Drives



ON Semiconductor®

<http://onsemi.com>



DFN6 3x3
MN SUFFIX
CASE 506AH

MARKING DIAGRAM

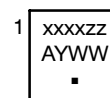

Pb-Free

xxx = 690, 691, 692, V690
zz = 15, 18, 25, 33, 50, AD
A = Assembly Location
Y = Year
WW = Work Week
▪ = Pb-Free Package

PIN ASSIGNMENT

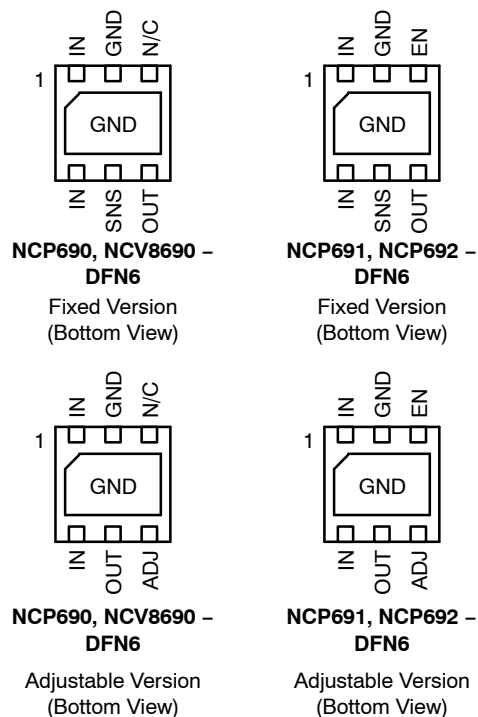

ORDERING INFORMATION

See detailed ordering and shipping information in the package dimensions section on page 14 of this data sheet.

NCP690, NCP691, NCP692, NCV8690

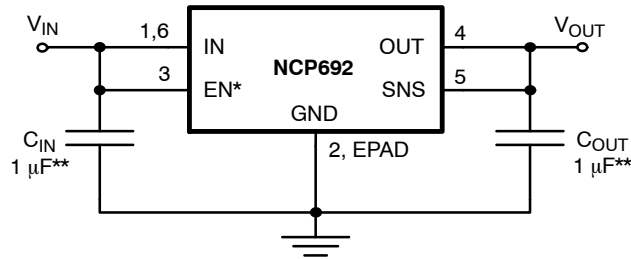

Note: * NCP692 device has EN active high
 ** Minimum value required for stability

Figure 1. NCP692 Typical Application Circuit for Fixed Version
 (Output voltage versions: 1.5 V, 1.8 V, 2.5 V, 5.0 V)

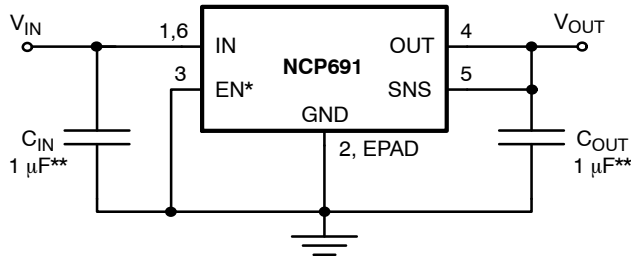

Note: * NCP691 device has EN active low
 ** Minimum value required for stability

Figure 2. NCP691 Typical Application Circuit for Fixed Version
 (Output voltage versions: 1.5 V, 1.8 V, 2.5 V, 5.0 V)

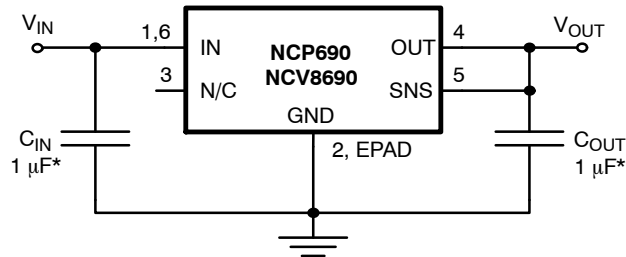

Note: * Minimum value required for stability

Figure 3. NCP690, NCV8690 Typical Application Circuit for Fixed Version
 (Output voltage versions: 1.5 V, 1.8 V, 2.5 V, 5.0 V)

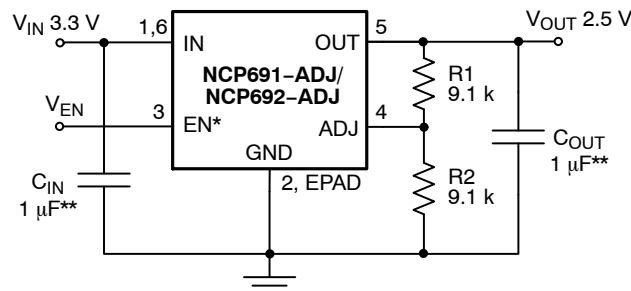

Note: * NCP691-ADJ device has EN active low and
 NCP692-ADJ device has EN active high
 ** Minimum value required for stability

Figure 4. NCP692 Typical Application Circuit for Adjustable Version
 (Adjustable version for $1.25 \text{ V} < V_{\text{OUT}} \leq 5.0 \text{ V}$)

NCP690, NCP691, NCP692, NCV8690

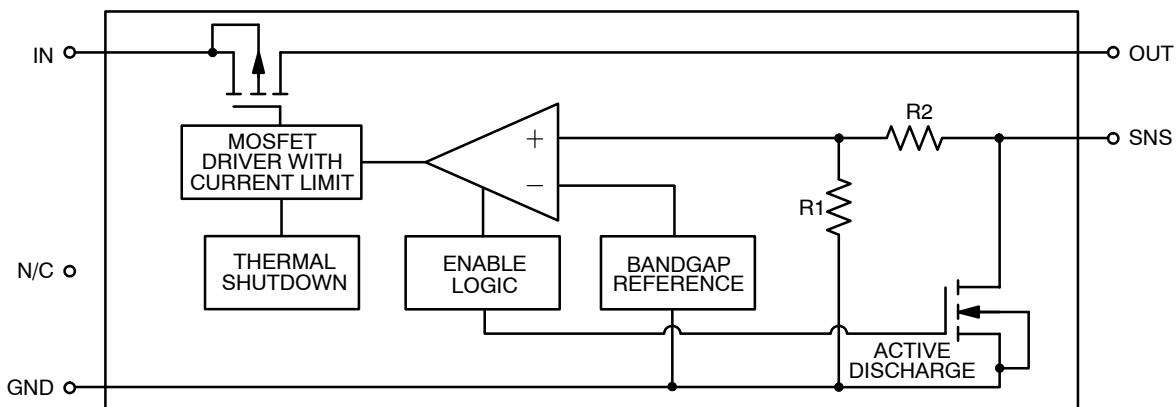

Figure 5. NCP690, NCV8690 Block Diagram (Fixed Version)

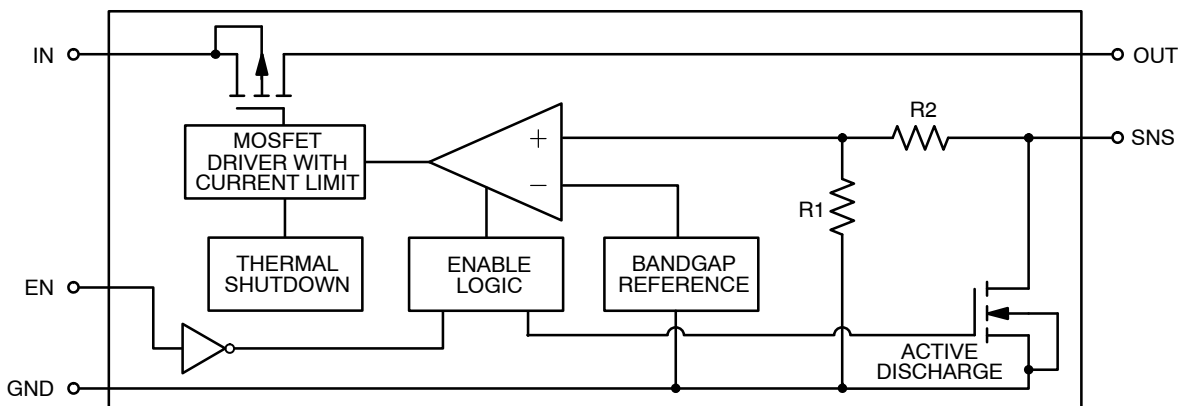

Figure 6. NCP691 Block Diagram (Fixed Version)

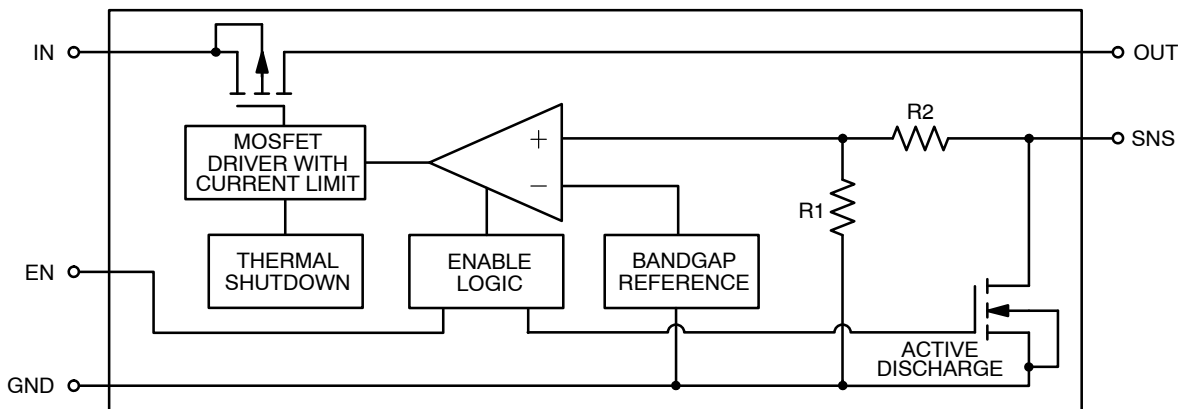

Figure 7. NCP692 Block Diagram (Fixed Version)

Table 1. PIN FUNCTION DESCRIPTION FOR FIXED VERSION

Pin No.	Pin Name	Description
1, 6	IN	Voltage inputs which supplies the current to the regulator. Both of these pins should be connected together for full output current capability
2	GND	Power supply ground of the regulator. Connected to the die through the lead frame. Soldered to the copper plane allows for effective heat removal.
3	EN	For NCP691 and NCP692 this pin functions as Enable Active Low and Enable Active High respectively. For NCP690/NCV8690 this pin has no special meaning and should be left disconnected.
4	OUT	Regulated output voltage
5	SNS	Sense input. This pin should be connected directly to OUT pin.

NCP690, NCP691, NCP692, NCV8690

Table 3. ABSOLUTE MAXIMUM RATINGS

Rating		Symbol	Value	Unit
Input Voltage (Note 1)		V_{IN}	-0.3 to 6.5	V
Chip Enable Voltage		V_{EN}	-0.3 to 6.5	V
Output Voltage		V_{OUT}	-0.3 to 6.5	V
Output Voltage / Sense Input, (SNS pin)		V_{SNS}	-0.3 to 6.5	V
Electrostatic Discharge	Human Body Model	ESD	4000	V
	Machine Model		200	
Maximum Junction Temperature		T_{J_MAX}	150	°C
Storage Temperature Range		T_{STG}	-65 to 150	°C

Stresses exceeding those listed in the Maximum Ratings table may damage the device. If any of these limits are exceeded, device functionality should not be assumed, damage may occur and reliability may be affected.

NOTE: This device series contains ESD protection and exceeds the following tests:

ESD HBM tested per JEDEC standard: JESD22-A114

ESD MM tested per JEDEC standard: JESD22-A115

Latch-up Current Maximum Rating: ≤ 150 mA per JEDEC standard: JESD78

Table 4. PACKAGE THERMAL CHARACTERISTICS

Rating		Condition	Symbol	Value	Unit
Thermal Resistance, Junction-to-Ambient (Note 2)	DFN6 3x3, 1 oz Cu	64 mm ² Cu 645 mm ² Cu	$R_{\theta JA}$	169 70	°C/W
	DFN6 3x3, 2 oz Cu	64 mm ² Cu 645 mm ² Cu	$R_{\theta JA}$	151 62	°C/W
Thermal Resistance, Junction-to-Pin			$R_{\theta JL}$	15	°C/W

Table 5. OPERATING RANGES

Rating	Symbol	Value	Unit
Operating Input Voltage (Notes 3 and 4)	V_{IN}	1.5 to 6.0	V
Operating Junction Temperature Range	T_J	-40 to 125	°C

Functional operation above the stresses listed in the Recommended Operating Ranges is not implied. Extended exposure to stresses beyond the Recommended Operating Ranges limits may affect device reliability.

1. Minimum $V_{IN} = (V_{OUT} + V_{DO})$ or 1.5 V, whichever is higher.
2. Soldered on FR4 copper area, please refer to Applications Section for Safe Operating Area.
3. Minimum $V_{IN} = (V_{OUT} + V_{DO})$ or 1.5 V, whichever is higher.
4. Refer to Electrical Characteristics and Application Information for Safe Operating Area.

NCP690, NCP691, NCP692, NCV8690

Table 6. ELECTRICAL CHARACTERISTICS $V_{IN} = (V_{OUT} + 1\text{ V})$, $V_{EN} = V_{IN}$, $I_{OUT} = 1\text{ mA}$, $C_{IN} = 10\text{ }\mu\text{F}$, $C_{OUT} = 10\text{ }\mu\text{F}$, for typical values $T_J = 25^\circ\text{C}$, for Min/Max values $T_J = -40^\circ\text{C}$ to 125°C ; unless otherwise noted. (Note 5)

Parameter	Test Conditions	Symbol	Min	Typ	Max	Unit
Output voltage (Adjustable Version)	$V_{IN} = 1.75\text{ V to }6.0\text{ V}$ $I_{OUT} = 100\text{ }\mu\text{A to }1\text{ A}$	V_{OUT}	1.231 (-1.5%)	1.250	1.269 (+1.5%)	V
Output voltage (Fixed Version)	$V_{IN} = (V_{OUT} + 1\text{ V})\text{ to }6.0\text{ V}$ $I_{OUT} = 100\text{ }\mu\text{A to }1\text{ A}$	V_{OUT}	1.470 1.764 2.450 3.234 4.900 (-2%)	1.5 1.8 2.5 3.3 5.0	1.530 1.836 2.550 3.366 5.100 (+2%)	V
Line regulation	$V_{IN} = (V_{OUT} + 1\text{ V})\text{ to }6.0\text{ V}$	Reg_{LINE}	-	3.2	8	mV
Load regulation	$I_{OUT} = 100\text{ }\mu\text{A to }1\text{ A}$	Reg_{LOAD}	-	10	30	mV
	$V_{OUT} = 1.5\text{ V}$ $V_{OUT} = 1.8\text{ V}$ $V_{OUT} = 2.5\text{ V}$ $V_{OUT} = 3.3\text{ V}$ $V_{OUT} = 5.0\text{ V}$		-	10 10 10 10 10	30 35 35 40	
Dropout voltage (Adjustable Version, Note 6)	$V_{DO} = V_{IN} - V_{OUT}$ $V_{OUT} = 1.25\text{ V}$ $I_{OUT} = 1\text{ A}$	V_{DO}	-	450	470	mV
Dropout voltage (Fixed Version, Note 9)	$I_{OUT} = 1\text{ A}$	V_{DO}	-	290	410	mV
	$V_{OUT} = 1.5\text{ V}$ $V_{OUT} = 1.8\text{ V}$ $V_{OUT} = 2.5\text{ V}$ $V_{OUT} = 3.3\text{ V}$ $V_{OUT} = 5.0\text{ V}$		-	240 190 180 120	380 300 250 210	
Ground current	$V_{IN} = V_{OUT} + 1\text{ V}$, $V_{OUT} = 1.5\text{ V, }1.8\text{ V, }2.5\text{ V, }3.3\text{ V}$	I_{GND}	-	145	200	μA
	$I_{OUT} = 1\text{ A}$ $I_{OUT} = 10\text{ }\mu\text{A}$ $I_{OUT} = 100\text{ }\mu\text{A}$		-	145	200	
	$V_{IN} = V_{OUT} + 1\text{ V}$, $V_{OUT} = 5.0\text{ V}$	I_{GND}	-	145	240	μA
	$I_{OUT} = 1\text{ A}$ $I_{OUT} = 10\text{ }\mu\text{A}$ $I_{OUT} = 100\text{ }\mu\text{A}$		-	145	240	
Disable current (NCP692 only, Notes 5 and 7)	$V_{EN} < 0.4\text{ V}$	I_{DIS}	-	0.1	1	μA
Output Current Limit	$V_{IN} = V_{OUT} + 1\text{ V}$, $V_{OUT} = 85\% V_{OUT_NOM}$	I_{LIM}	1.1	1.6	2.4	A
Short Circuit Current	$V_{OUT} = 0\text{ V}$	I_{SC}	1.2	-	-	A
Enable High Level Threshold	V_{EN} increasing from low to high logic level	V_{EN_HI}	0.9	-	-	V
Enable Low Level Threshold (NCP691 and NCP692)	V_{EN} decreasing from high to low logic level	V_{EN_LO}	-	-	0.4	
Enable Input Current (Enable Active Low) (NCP691 only, Note 8)	$V_{EN} = 0.9\text{ V to }V_{IN}$	I_{EN_HI}	-	0.01	250	nA
Enable Input Current (NCP692 only, Note 8)	$V_{EN} = 0\text{ V}$	I_{EN_LO}	-	0.01	100	nA
Feedback Current	$V_{FB} = 1.25$ (Adjustable version only)	I_{IFB}	-	210	320	nA

Product parametric performance is indicated in the Electrical Characteristics for the listed test conditions, unless otherwise noted. Product performance may not be indicated by the Electrical Characteristics if operated under different conditions.

5. Performance guaranteed over the indicated operating temperature range by design and/or characterization tested at $T_J = T_A = 25^\circ\text{C}$. Low duty cycle pulse techniques are used during testing to maintain the junction temperature as close to ambient as possible.
6. Maximum dropout voltage is limited by minimum input voltage. $V_{IN} = 1.7\text{ V}$ recommended for guaranteed operation at maximum output current.
7. Refer to the Applications Information Section.
8. Values based on design and/or characterization.
9. Dropout voltage is defined as the differential voltage between V_{OUT} and V_{IN} , when V_{OUT} drops 100 mV below its nominal value.

NCP690, NCP691, NCP692, NCV8690

Table 6. ELECTRICAL CHARACTERISTICS $V_{IN} = (V_{OUT} + 1\text{ V})$, $V_{EN} = V_{IN}$, $I_{OUT} = 1\text{ mA}$, $C_{IN} = 10\text{ }\mu\text{F}$, $C_{OUT} = 10\text{ }\mu\text{F}$, for typical values $T_J = 25^\circ\text{C}$, for Min/Max values $T_J = -40^\circ\text{C}$ to 125°C ; unless otherwise noted. (Note 5) (continued)

Parameter	Test Conditions	Symbol	Min	Typ	Max	Unit
Turn-on Time (Note 8)	$V_{IN} = 0\text{ V}$ to $(V_{OUT} + 1\text{ V})$ or 1.75 V $V_{OUT} = 0\text{ V}$ to $90\% V_{OUT_NOM}$	t_{ON}	-	50	-	μs
Power supply ripple rejection (Note 8)	$V_{OUT} = 1.25\text{ V}$ $V_{IN} = V_{OUT} + 1\text{ V}$, with $V_{PP} = 0.5\text{ V}$, $C_{OUT} = 1\text{ }\mu\text{F}$	$f = 120\text{ Hz}$ $f = 1\text{ kHz}$ $f = 10\text{ kHz}$	-	62 55 40	-	dB
Output noise voltage (Note 8)	$BW = 200\text{ Hz}$ to 100 kHz , $C_{IN} = 1\text{ }\mu\text{F}$, $C_{OUT} = 10\text{ }\mu\text{F}$, $T_A = 25^\circ\text{C}$	V_N	-	50	-	μV_{rms}
Thermal Shutdown Temperature (Note 8)		T_{SD}	-	175	-	$^\circ\text{C}$
Thermal Shutdown Hysteresis (Note 8)		T_{SH}	-	10	-	$^\circ\text{C}$

Product parametric performance is indicated in the Electrical Characteristics for the listed test conditions, unless otherwise noted. Product performance may not be indicated by the Electrical Characteristics if operated under different conditions.

- Performance guaranteed over the indicated operating temperature range by design and/or characterization tested at $T_J = T_A = 25^\circ\text{C}$. Low duty cycle pulse techniques are used during testing to maintain the junction temperature as close to ambient as possible.
- Maximum dropout voltage is limited by minimum input voltage. $V_{IN} = 1.7\text{ V}$ recommended for guaranteed operation at maximum output current.
- Refer to the Applications Information Section.
- Values based on design and/or characterization.
- Dropout voltage is defined as the differential voltage between V_{OUT} and V_{IN} , when V_{OUT} drops 100 mV below its nominal value.

TYPICAL CHARACTERISTICS

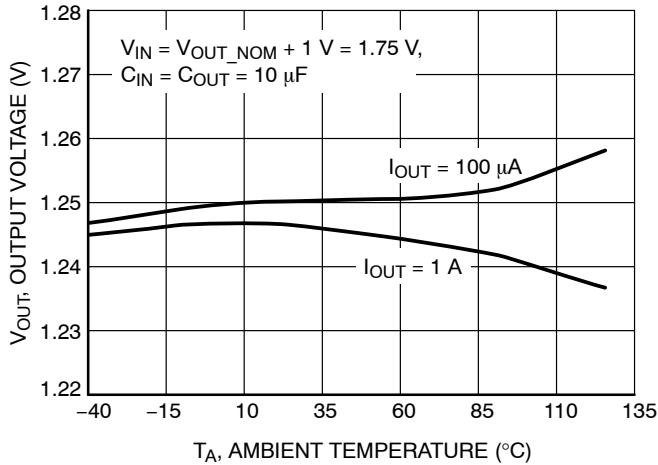

Figure 11. Output Voltage vs. Temperature
($V_{out} = 1.25\text{ V}$)

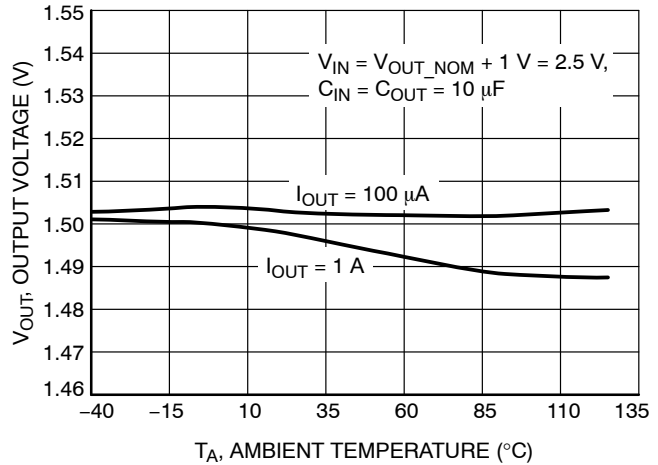

Figure 12. Output Voltage vs. Temperature
($V_{out} = 1.5\text{ V}$)

NCP690, NCP691, NCP692, NCV8690

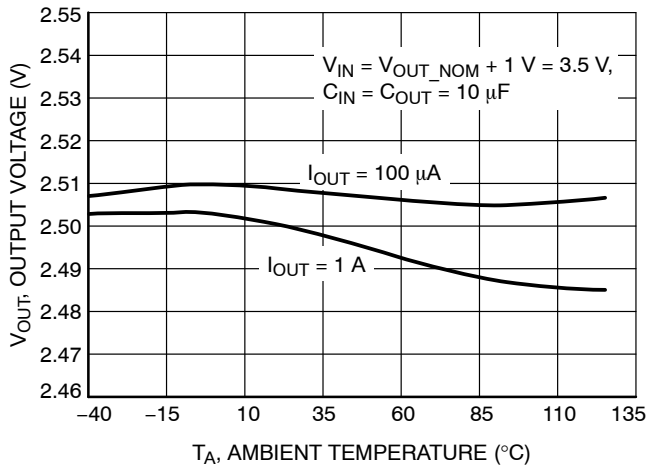

Figure 13. Output Voltage vs. Temperature
(V_{out} = 2.5 V)

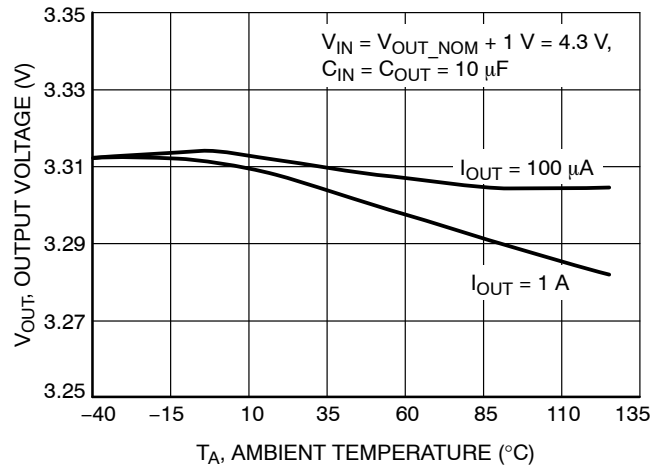

Figure 14. Output Voltage vs. Temperature
(V_{out} = 3.3 V)

TYPICAL CHARACTERISTICS

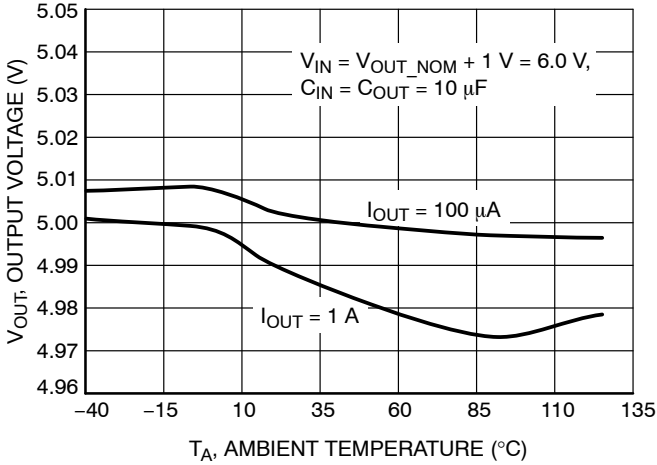

Figure 15. Output Voltage vs. Temperature
($V_{out} = 5.0\text{ V}$)

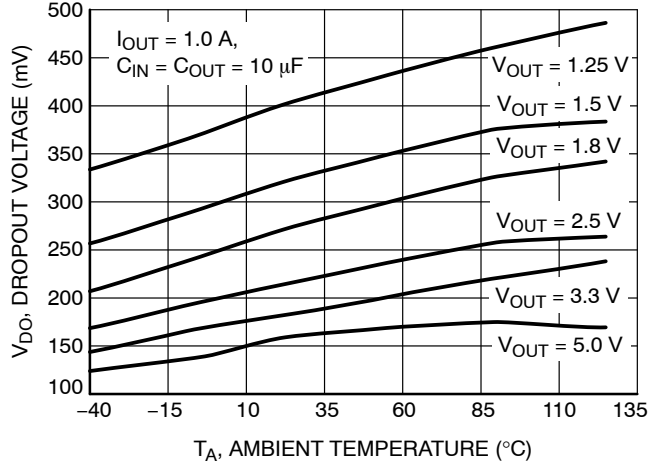

Figure 16. Dropout Voltage vs. Temperature
($V_{out} = 1.25\text{ V}, 1.5\text{ V}, 1.8\text{ V}, 2.5\text{ V}, 3.3\text{ V}, 5.0\text{ V}$)

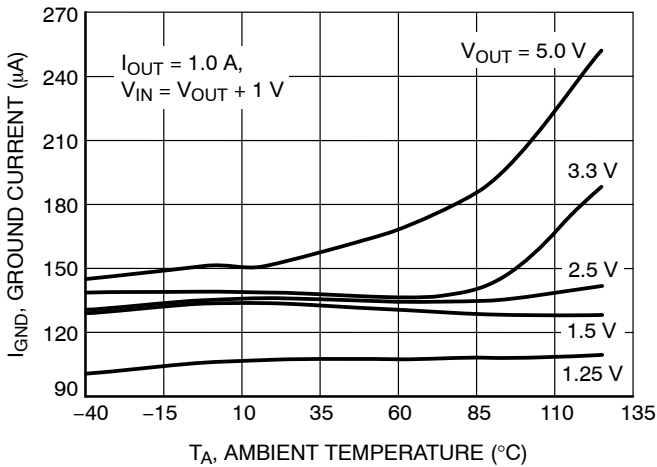

Figure 17. Ground Current vs. Temperature
($V_{out} = 1.25\text{ V}, 1.5\text{ V}, 2.5\text{ V}, 3.3\text{ V}, 5.0\text{ V}$)

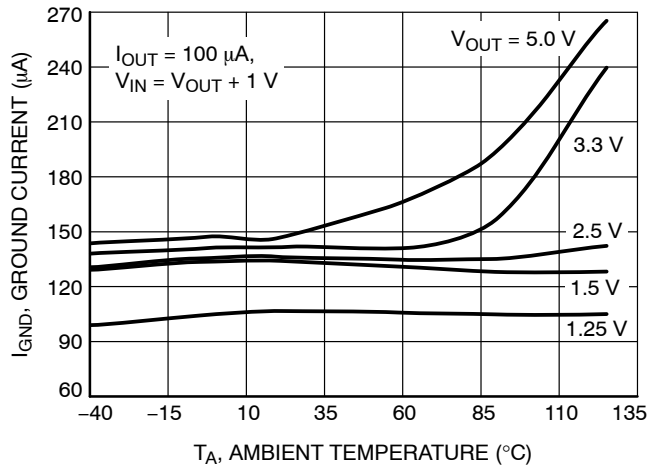

Figure 18. Ground Current vs. Temperature
($V_{out} = 1.25\text{ V}, 1.5\text{ V}, 2.5\text{ V}, 3.3\text{ V}, 5.0\text{ V}$)

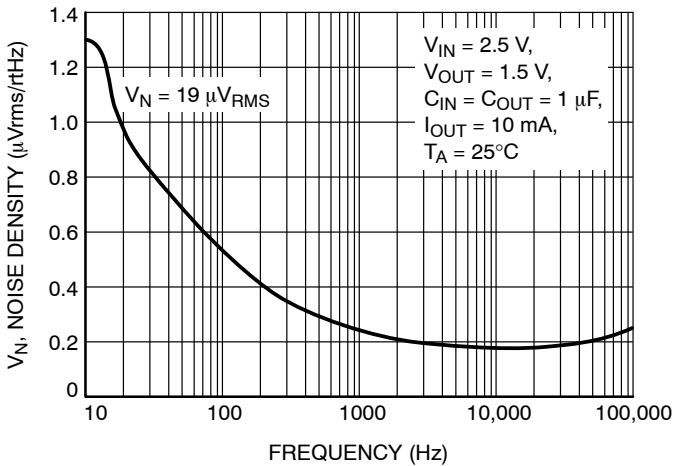

Figure 19. Noise Density vs. Frequency
($V_{out} = 1.5\text{ V}$)

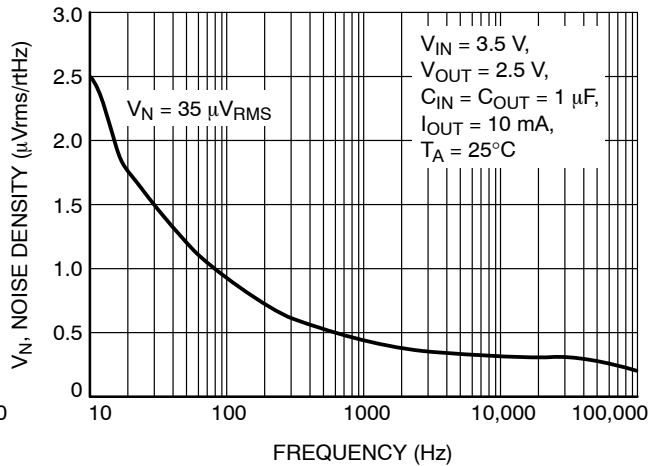

Figure 20. Noise Density vs. Frequency
($V_{out} = 2.5\text{ V}$)

TYPICAL CHARACTERISTICS

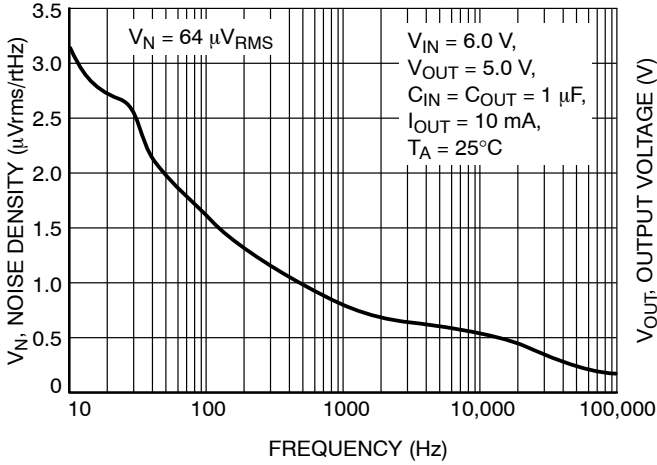

Figure 21. Noise Density vs. Frequency
($V_{out} = 5.0\text{ V}$)

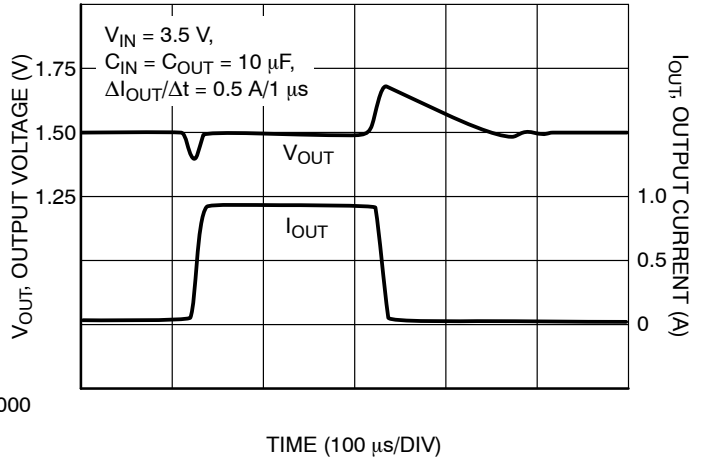

Figure 22. Load Transient
($V_{out} = 1.5\text{ V}$)

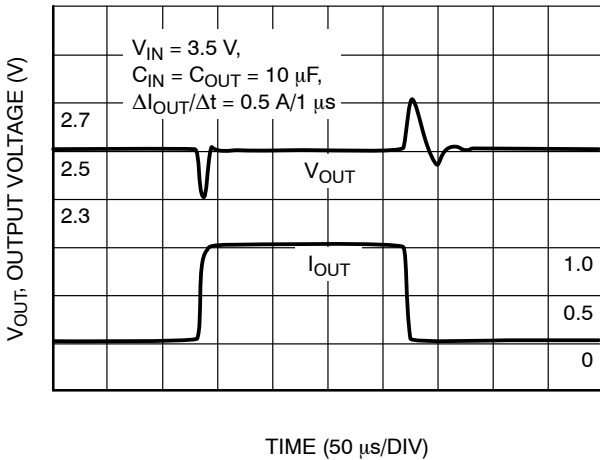

Figure 23. Load Transient
($V_{out} = 2.5\text{ V}$)

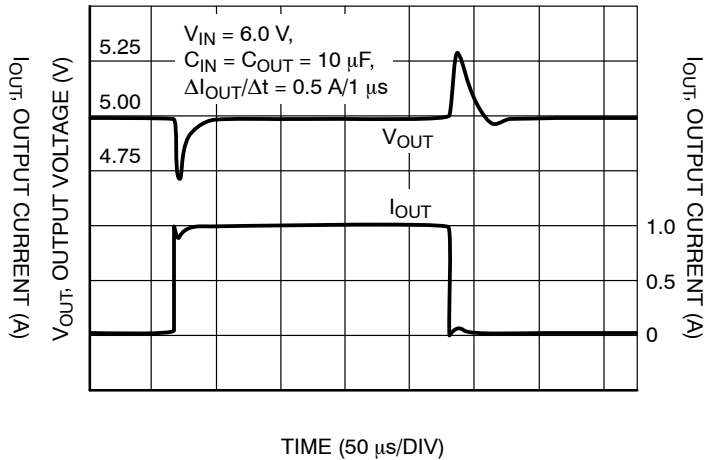

Figure 24. Load Transient
($V_{out} = 5.0\text{ V}$)

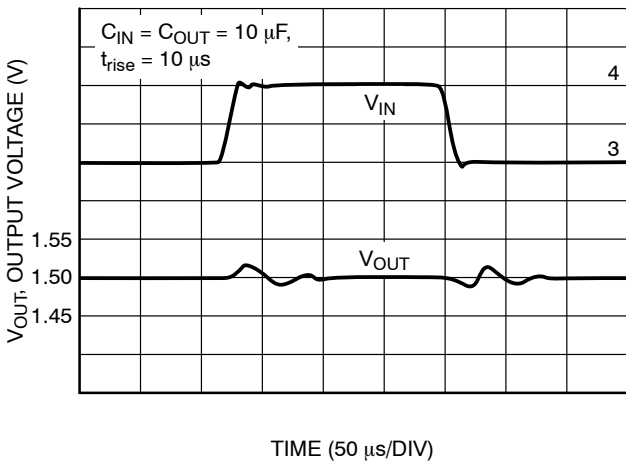

Figure 25. Line Transient
($V_{out} = 1.5\text{ V}$)

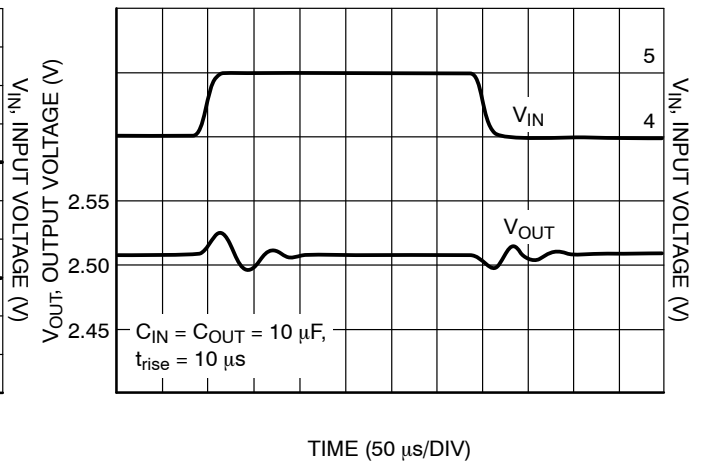

Figure 26. Line Transient
($V_{out} = 2.5\text{ V}$)

TYPICAL CHARACTERISTICS

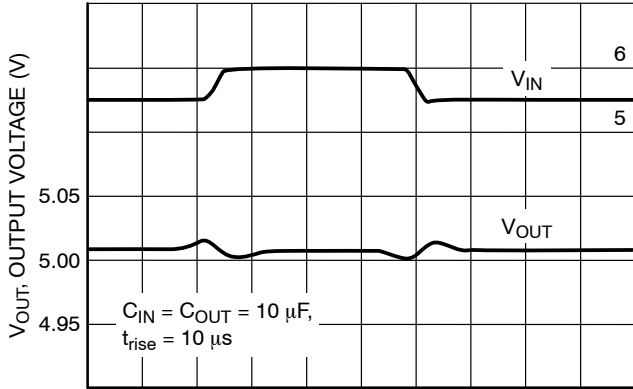

Figure 27. Line Transient
(V_{out} = 5.0 V)

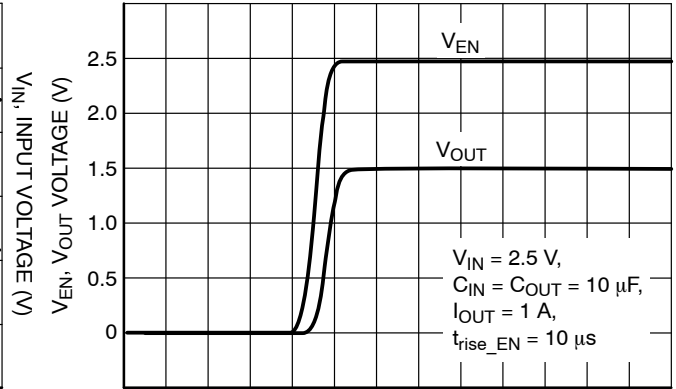

Figure 28. Start-Up Transient
(V_{out} = 1.5 V)

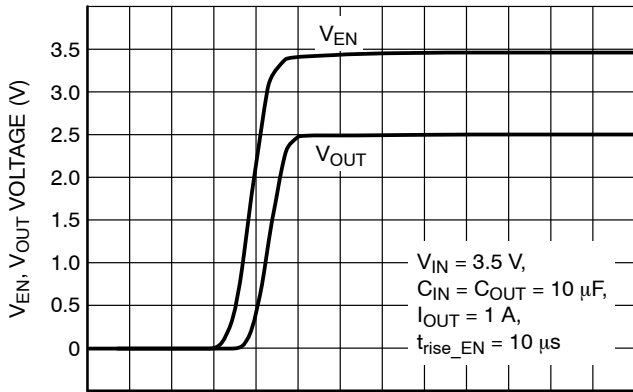

Figure 29. Start-Up Transient
(V_{out} = 2.5 V)

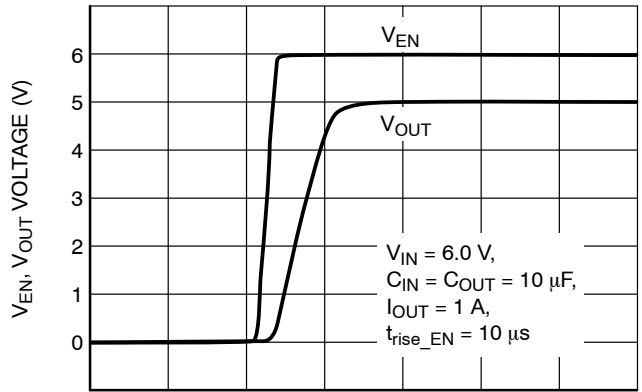

Figure 30. Start-Up Transient
(V_{out} = 5.0 V)

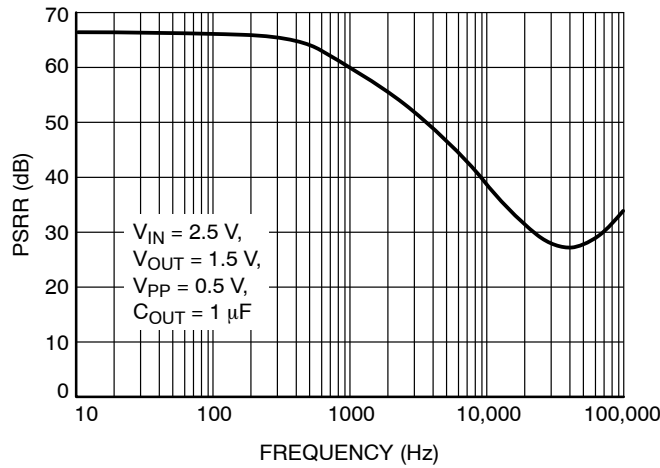

Figure 31. PSRR vs. Frequency
(V_{out} = 1.5 V)

DEFINITIONS

Load Regulation

The change in output voltage for a change in output load current at a constant temperature.

Dropout Voltage

The input/output differential at which the regulator output no longer maintains regulation against further reductions in input voltage. Measured, when the output drops 100 mV below its nominal value. The junction temperature, load current, and minimum input supply requirements affect the dropout level.

Output Noise Voltage

This is the integrated value of the output noise over a specified frequency range. Input voltage and output load current are kept constant during the measurement. Results are expressed in μV_{rms} or $\text{nV}/\sqrt{\text{Hz}}$.

Ground Current

Ground Current is the current that flows through the ground pin when the regulator operates without a load on its output (I_{GND}). This consists of internal IC operation, bias, etc. It is actually the difference between the input current (measured through the LDO input pin) and the output load current. If the regulator has an input pin that reduces its internal bias and shuts off the output (enable/disable function), this term is called the disable current (I_{DIS}).

Line Regulation

The change in output voltage for a change in input voltage. The measurement is made under conditions of low dissipation or by using pulse techniques such that the average junction temperature is not significantly affected.

Line Transient Response

Typical output voltage overshoot and undershoot response when the input voltage is excited with a given slope.

Load Transient Response

Typical output voltage overshoot and undershoot response when the output current is excited with a given slope between no-load and full-load conditions.

Thermal Protection

Internal thermal shutdown circuitry is provided to protect the integrated circuit in the event that the maximum junction temperature is exceeded. When activated at typically 175°C , the regulator turns off. This feature is provided to prevent failures from accidental overheating.

Maximum Package Power Dissipation

The power dissipation level at which the junction temperature reaches its maximum operating value.

APPLICATIONS INFORMATION

The NCP690 regulator is self-protected with internal thermal shutdown and internal current limit. Typical application circuit is shown in Figure 1.

Input Decoupling (C_{IN})

A ceramic 10 μF capacitor is recommended and should be connected close to the NCP690 package. Higher capacitance and lower ESR will improve the overall line transient response.

Output Decoupling (C_{OUT})

The NCP690 does not require a minimum Equivalent Series Resistance (ESR) for the output capacitor. The minimum output decoupling capacitor required for stability is 1 μF . In order to improve the load transient response and start up performance 10 μF capacitor is recommended. The regulator is stable with ceramic chip as well as tantalum capacitors. Larger values improve noise rejection and load transient response.

No-Load Regulation Considerations

The required minimum 100 μA load current is assured by the internal resistor divider network.

The NCP690 contain an overshoot clamp circuit to improve transient response during a load current step release. When output voltage exceeds the nominal by

approximately 20 mV, this circuit becomes active and clamps the output from further voltage increase. Tying the ENABLE pin to V_{IN} will ensure that the part is active whenever the supply voltage is present,

Noise Decoupling

The NCP690 is a low noise regulator and needs no external noise reduction capacitor. Unlike other low noise regulators which require an external capacitor and have slow startup times, the NCP690 operates without a noise reduction capacitor, has a typical 50 μs turn-on time and achieves a 50 μV_{rms} overall noise level between 10 Hz and 100 kHz.

Enable Operation

The enable pin will turn the regulator on or off. The threshold limits are covered in the electrical characteristics table in this data sheet. The turn-on/turn-off transient voltage being supplied to the enable pin should exceed a slew rate of 10 $\text{mV}/\mu\text{s}$ to ensure correct operation. If the enable function is not to be used then the pin should be connected to V_{IN} .

Adjustable Operation

The output voltage can be adjusted from 1 to 4 times the typical 1.250 V regulation voltage by the use of resistor

NCP690, NCP691, NCP692, NCV8690

divider network as shown on Figure 4. The output voltage and resistors should be chosen using Equations 1 and 2.

$$V_{OUT} = 1.250 \left(1 + \frac{R_1}{R_2} \right) + (I_{ADJ} \cdot R_1) \quad (\text{eq. 1})$$

$$R_2 \cong R_1 \frac{1}{\frac{V_{OUT}}{1.25} - 1} \quad (\text{eq. 2})$$

Input bias current I_{ADJ} is typically less than 210 nA. Choose R_1 arbitrarily to minimize errors due to the bias current and to minimize noise contribution to the output voltage. Use Equation 2 to find the required value for R_2 . If an output voltage of 1.25 V is desired, the adjustable pin should be connected directly to the output pin.

Thermal Characteristics

As power dissipated in the NCP690 increases, it might become necessary to provide some thermal relief. The maximum power dissipation supported by the device is dependent upon board design and layout. Mounting pad configuration on the PCB, the board material, and the ambient temperature affect the rate of junction temperature rise for the part. When the NCP690 has good thermal conductivity through the PCB, the junction temperature will be relatively low with high power applications. The maximum dissipation the NCP690 can handle is given by:

$$P_{D(MAX)} = \frac{[T_{J(MAX)} - T_A]}{R_{\theta JA}} \quad (\text{eq. 3})$$

Since T_J is not recommended to exceed 125°C ($T_{J(MAX)}$), then the NCP690 can dissipate up to 1 W when the ambient temperature (T_A) is 25°C.

The power dissipated by the NCP690 can be calculated from the following equations:

$$P_D \approx V_{IN}(I_{GND} @ I_{OUT}) + I_{OUT}(V_{IN} - V_{OUT}) \quad (\text{eq. 4})$$

or

$$V_{IN(MAX)} \approx \frac{P_{D(MAX)} + (V_{OUT} \times I_{OUT})}{I_{OUT} + I_{GND}} \quad (\text{eq. 5})$$

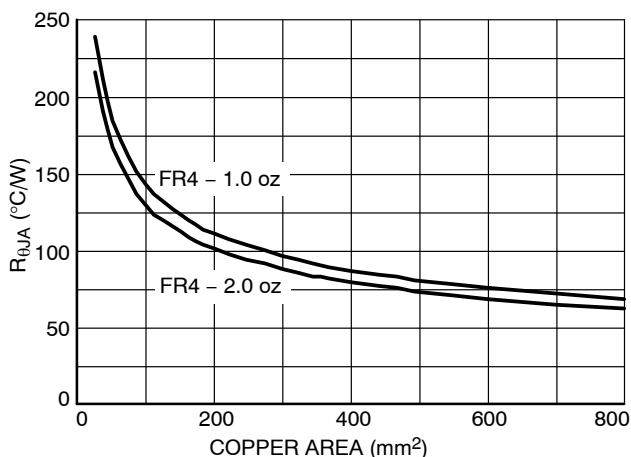

Figure 32. Thermal Resistance vs. Copper Area

Hints

V_{IN} and GND printed circuit board traces should be as wide as possible. When the impedance of these traces is high, there is a chance to pick up noise or cause the regulator to malfunction. Place external components, especially the output capacitor, as close as possible to the NCP690, and make traces as short as possible.

NCP690, NCP691, NCP692, NCV8690

DEVICE ORDERING INFORMATION

Device	Nominal Output Voltage	Marking	Package	Shipping [†]
NCP690MN15T2G	1.5 V	69015	DFN6 (Pb-Free)	3000 / Tape & Reel
NCP690MN18T2G	1.8 V	69018	DFN6 (Pb-Free)	3000 / Tape & Reel
NCP690MN25T2G	2.5 V	69025	DFN6 (Pb-Free)	3000 / Tape & Reel
NCP690MN33T2G	3.3 V	69033	DFN6 (Pb-Free)	3000 / Tape & Reel
NCP690MN50T2G	5.0 V	69050	DFN6 (Pb-Free)	3000 / Tape & Reel
NCP690MNADJT2G	ADJ	690AD	DFN6 (Pb-Free)	3000 / Tape & Reel
NCP691MN15T2G	1.5 V	69115	DFN6 (Pb-Free)	3000 / Tape & Reel
NCP691MN18T2G	1.8 V	69118	DFN6 (Pb-Free)	3000 / Tape & Reel
NCP691MN25T2G	2.5 V	69125	DFN6 (Pb-Free)	3000 / Tape & Reel
NCP691MN33T2G	3.3 V	69133	DFN6 (Pb-Free)	3000 / Tape & Reel
NCP691MN50T2G	5.0 V	69150	DFN6 (Pb-Free)	3000 / Tape & Reel
NCP691MNADJT2G	ADJ	691AD	DFN6 (Pb-Free)	3000 / Tape & Reel
NCP692MN15T2G	1.5 V	69215	DFN6 (Pb-Free)	3000 / Tape & Reel
NCP692MN18T2G	1.8 V	69218	DFN6 (Pb-Free)	3000 / Tape & Reel
NCP692MN25T2G	2.5 V	69225	DFN6 (Pb-Free)	3000 / Tape & Reel
NCP692MN33T2G	3.3 V	69233	DFN6 (Pb-Free)	3000 / Tape & Reel
NCP692MN50T2G	5.0 V	69250	DFN6 (Pb-Free)	3000 / Tape & Reel
NCP692MNADJT2G	ADJ	692AD	DFN6 (Pb-Free)	3000 / Tape & Reel
NCV8690MN33T2G*	3.3 V	V69033	DFN6 (Pb-Free)	3000 / Tape & Reel

[†]For information on tape and reel specifications, including part orientation and tape sizes, please refer to our Tape and Reel Packaging Specifications Brochure, BRD8011/D.

*NCV Prefix for Automotive and Other Applications Requiring Unique Site and Control Change Requirements; AEC-Q100 Qualified and PPAP Capable.

MECHANICAL CASE OUTLINE

PACKAGE DIMENSIONS

ON Semiconductor®



1
SCALE 2:1

DFN6 3*3 MM, 0.95 PITCH
CASE 506AH-01
ISSUE O

DATE 17 NOV 2004

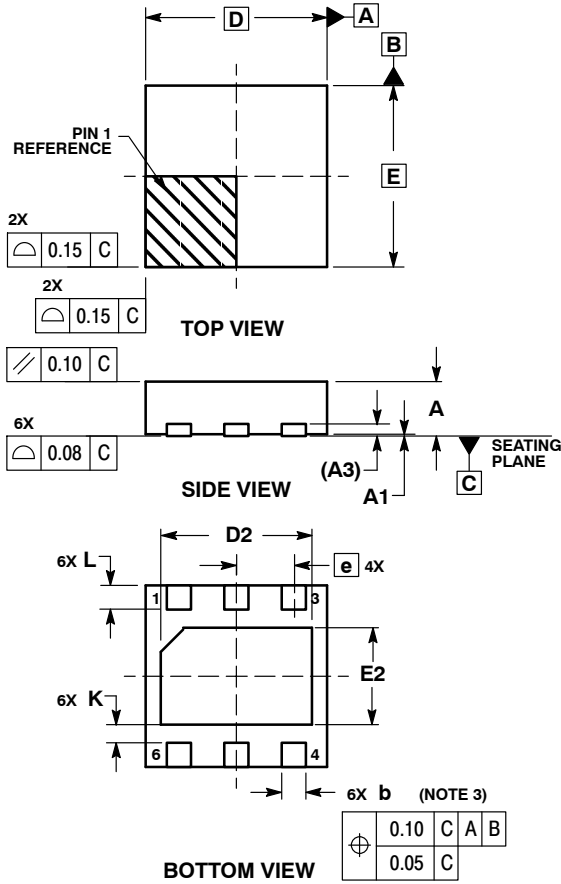

NOTES:

1. DIMENSIONS AND TOLERANCING PER ASME Y14.5M, 1994.
2. CONTROLLING DIMENSION: MILLIMETERS.
3. DIMENSION b APPLIES TO PLATED TERMINAL AND IS MEASURED BETWEEN 0.25 AND 0.30 MM FROM TERMINAL.
4. COPLANARITY APPLIES TO THE EXPOSED PAD AS WELL AS THE TERMINALS.

MILLIMETERS			
DIM	MIN	NOM	MAX
A	0.80	0.90	1.00
A1	0.00	0.03	0.05
A3	0.20 REF		
b	0.35	0.40	0.45
D	3.00 BSC		
D2	2.40	2.50	2.60
E	3.00 BSC		
E2	1.50	1.60	1.70
e	0.95 BSC		
K	0.21	---	---
L	0.30	0.40	0.50

GENERIC MARKING DIAGRAM*

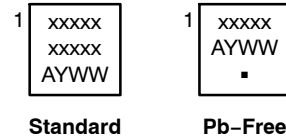

- xxxxx = Specific Device Code
- A = Assembly Location
- Y = Year
- WW = Work Week
- = Pb-Free Package

SOLDERING FOOTPRINT*

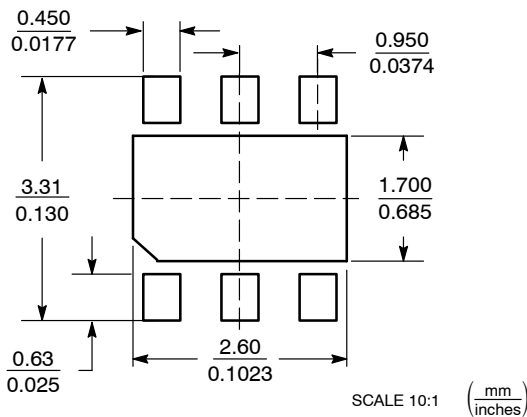

*This information is generic. Please refer to device data sheet for actual part marking.
Pb-Free indicator, "G" or microdot "■", may or may not be present.

*For additional information on our Pb-Free strategy and soldering details, please download the ON Semiconductor Soldering and Mounting Techniques Reference Manual, SOLDERRM/D.

DOCUMENT NUMBER:	98AON19891D	Electronic versions are uncontrolled except when accessed directly from the Document Repository. Printed versions are uncontrolled except when stamped "CONTROLLED COPY" in red.
DESCRIPTION:	DFN6 3*3 MM, 0.95 PITCH, SINGLE FLAG	PAGE 1 OF 1

ON Semiconductor and ON are trademarks of Semiconductor Components Industries, LLC dba ON Semiconductor or its subsidiaries in the United States and/or other countries. ON Semiconductor reserves the right to make changes without further notice to any products herein. ON Semiconductor makes no warranty, representation or guarantee regarding the suitability of its products for any particular purpose, nor does ON Semiconductor assume any liability arising out of the application or use of any product or circuit, and specifically disclaims any and all liability, including without limitation special, consequential or incidental damages. ON Semiconductor does not convey any license under its patent rights nor the rights of others.

onsemi, **Onsemi**, and other names, marks, and brands are registered and/or common law trademarks of Semiconductor Components Industries, LLC dba "**onsemi**" or its affiliates and/or subsidiaries in the United States and/or other countries. **onsemi** owns the rights to a number of patents, trademarks, copyrights, trade secrets, and other intellectual property. A listing of **onsemi**'s product/patent coverage may be accessed at www.onsemi.com/site/pdf/Patent-Marking.pdf. **onsemi** reserves the right to make changes at any time to any products or information herein, without notice. The information herein is provided "as-is" and **onsemi** makes no warranty, representation or guarantee regarding the accuracy of the information, product features, availability, functionality, or suitability of its products for any particular purpose, nor does **onsemi** assume any liability arising out of the application or use of any product or circuit, and specifically disclaims any and all liability, including without limitation special, consequential or incidental damages. Buyer is responsible for its products and applications using **onsemi** products, including compliance with all laws, regulations and safety requirements or standards, regardless of any support or applications information provided by **onsemi**. "Typical" parameters which may be provided in **onsemi** data sheets and/or specifications can and do vary in different applications and actual performance may vary over time. All operating parameters, including "Typicals" must be validated for each customer application by customer's technical experts. **onsemi** does not convey any license under any of its intellectual property rights nor the rights of others. **onsemi** products are not designed, intended, or authorized for use as a critical component in life support systems or any FDA Class 3 medical devices or medical devices with a same or similar classification in a foreign jurisdiction or any devices intended for implantation in the human body. Should Buyer purchase or use **onsemi** products for any such unintended or unauthorized application, Buyer shall indemnify and hold **onsemi** and its officers, employees, subsidiaries, affiliates, and distributors harmless against all claims, costs, damages, and expenses, and reasonable attorney fees arising out of, directly or indirectly, any claim of personal injury or death associated with such unintended or unauthorized use, even if such claim alleges that **onsemi** was negligent regarding the design or manufacture of the part. **onsemi** is an Equal Opportunity/Affirmative Action Employer. This literature is subject to all applicable copyright laws and is not for resale in any manner.

ADDITIONAL INFORMATION

TECHNICAL PUBLICATIONS:

Technical Library: www.onsemi.com/design/resources/technical-documentation
onsemi Website: www.onsemi.com

ONLINE SUPPORT: www.onsemi.com/support

For additional information, please contact your local Sales Representative at www.onsemi.com/support/sales

Looking for pricing, stock, or lifecycle information?

Click below to explore more details on WIN SOURCE:

 [View NCP691MN33T2G on WIN SOURCE](#)

 [ON Semiconductor](#) Information

Optimize Your Supply Chain with WIN SOURCE Solutions

-  Global Sourcing Solution
-  Obsolete Management
-  Cost Control Management
-  Shortage Management
-  Alternative Solution
-  Excess Inventory Management