



**THE DATASHEET OF  
NCP694HSAN12T1G**



# NCP694

## 1A CMOS Low-Dropout Voltage Regulator

The NCP694 series of fixed output super low dropout linear regulators are designed for portable battery powered applications with high output current requirement up to 1 A and  $-3$  mV typical load regulation at 1 A. Each device contains a voltage reference unit, an error amplifier, a PMOS power transistor, resistors for setting output voltage, a current limit circuits for overcurrent and thermal-shutdown. A standby mode with ultra low supply current can be realized with the chip enable function.

The device is housed in the SOT-89-5 and HSON-6 packages. Standard voltage versions are 0.8 V, 1.0 V, 1.2 V, 2.5 V, 3.3 V for fixed version and adjustable output voltage down to 1.0 V.

### Features

- Maximum Operating Voltage of 6.0 V
- Minimum Output Voltage Down to 0.8 V for Fix Version and 1.0 V for Adjustable Version
- Load Regulation  $-3$  mV at 1 A Output Current
- Low Dropout
- Build-in Auto Discharge Function for D Version
- Standby Mode With Low Consumption
- These are Pb-Free Devices

### Typical Applications

- Battery Powered Instruments
- Hand-Held Instruments
- Camcorders and Cameras
- Portable communication equipments



**ON Semiconductor®**

<http://onsemi.com>

### MARKING DIAGRAMS



SOT-89-5  
CASE 528AB

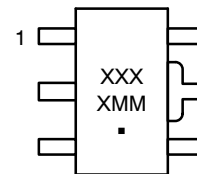

HSON-6  
CASE 506AE

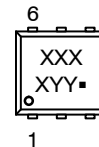

XXXX = Specific Device Code  
MM, YY = Lot Number  
G or ■ = Pb-Free Package

For actual marking Pb-Free indicator, "G" or micro-dot "■" may or may not be provided.

### ORDERING INFORMATION

See detailed ordering and shipping information in the package dimensions section on page 15 of this data sheet.

# NCP694

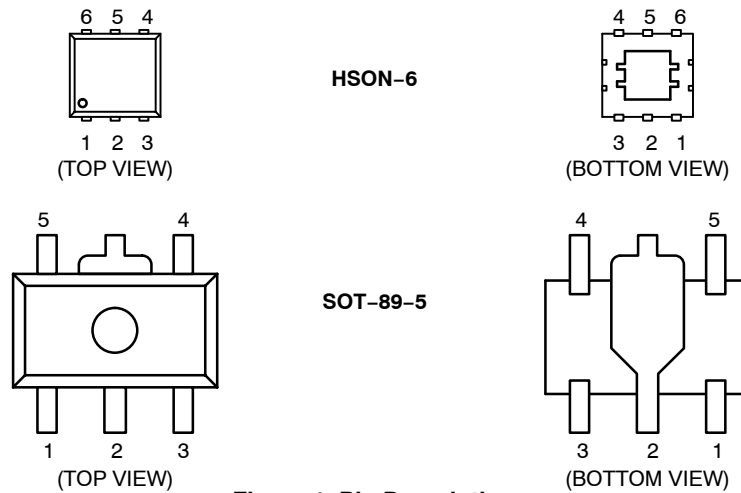

Figure 1. Pin Description

## PIN FUNCTION DESCRIPTION FOR SOT-89-5 PACKAGE

Pin No.	Pin Name	Description
1	ADJ/NC	Adjust pin for NCP694DADJHT1G and NCP694HADJHT1G / No connection
2	GND	Power supply ground
3	CE	This input is used to place the device into low-power standby. When this input is pulled low, the device is disabled. If this function is not used, Enable should be connected to $V_{in}$ .
4	$V_{in}$	Positive power supply input voltage.
5	$V_{out}$	Regulated output voltage.

## PIN FUNCTION DESCRIPTION FOR HSON-6 PACKAGE

Pin No.	Pin Name	Description
1	$V_{out}$	Regulated output voltage
2	$V_{out}$	Regulated output voltage
3	ADJ / NC	Adjust pin for NCP694DSANADJT1G and NCP694HSANADJT1G / No connection
4	GND	Power supply ground
5	CE	This input is used to place the device into low power standby. When this input is pulled low, the device is disabled. If this function is not used, Enable should be connected to $V_{in}$ .
6	$V_{in}$	Positive power supply input voltage

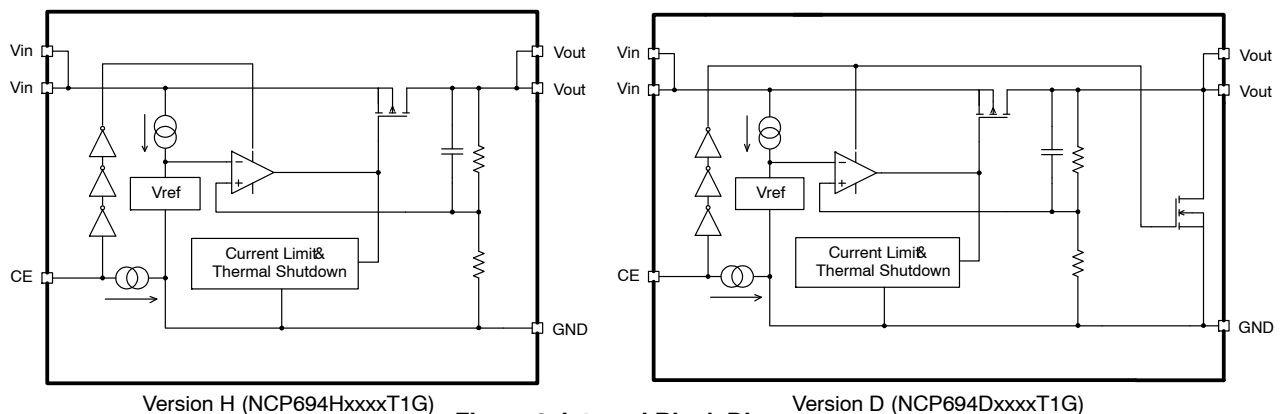

Figure 2. Internal Block Diagram

# NCP694

## MAXIMUM RATINGS

Rating	Symbol	Value	Unit
Input Voltage	$V_{in}$	6.5	V
Enable Voltage	$V_{CE}$	-0.3 to $V_{in}$	V
Output Voltage	$V_{out}$	-0.3 to $V_{in} + 0.3$	V
Power Dissipation SOT-89-5	$P_D$	900	mW
Power Dissipation HSON-6	$P_D$	900	mW
Operating Junction Temperature	$T_J$	+150	°C
Operating Ambient Temperature	$T_A$	-40 to +85	°C
Storage Temperature	$T_{stg}$	-55 to +125	°C

Stresses exceeding Maximum Ratings may damage the device. Maximum Ratings are stress ratings only. Functional operation above the Recommended Operating Conditions is not implied. Extended exposure to stresses above the Recommended Operating Conditions may affect device reliability.

1. This device series contains ESD protection and exceeds the following tests:  
Human Body Model 2000 V per JEDEC  
Machine Model Method 200 V

## THERMAL CHARACTERISTICS

Rating	Symbol	Test Conditions	Typical Value	Unit
Junction-to-Ambient SOT-89-5	$R_{\theta JA}$	1 oz Copper Thickness, 100 mm <sup>2</sup>	111	°C/W
Power Dissipation SOT-89-5	$P_D$		900	mW
Junction-to-Ambient HSON-6	$R_{\theta JA}$	1 oz Copper Thickness, 100 mm <sup>2</sup>	111	°C/W
Power Dissipation HSON-6	$P_D$		900	mW

NOTE: Single component mounted on an 80 x 80 x 1.5 mm FR4 PCB with stated copper head spreading area. Using the following boundary conditions as stated in EIA/JESD 51-1, 2, 3, 7, 12.

# NCP694

**ELECTRICAL CHARACTERISTICS FOR FIX VERSION** ( $V_{in} = V_{out(nom.)} + 1.0\text{ V}$ ,  $V_{CE} = V_{in}$ ,  $C_{in} = 4.7\ \mu\text{F}$ ,  $C_{out} = 4.7\ \mu\text{F}$ ,  $T_A = 25^\circ\text{C}$ , unless otherwise noted)

Characteristic	Symbol	Min	Typ	Max	Unit
Output Voltage ( $T_A = 25^\circ\text{C}$ , $I_{out} = 100\text{ mA}$ , $V_{in} - V_{out} = 1\text{ V}$ ) 0.8 V 1.0 V 1.2 V 2.5 V 3.3 V	$V_{out}$	0.770 0.970 1.170 2.450 3.234	0.8 1.0 1.2 2.5 3.3	0.830 1.030 1.030 2.550 3.366	V
Output Current ( $V_{in} - V_{out} = 1\text{ V}$ )	$I_{out}$		1		A
Input voltage	$V_{in}$	1.4		6.0	V
Line Regulation ( $I_{out} = 100\text{ mA}$ )	$Reg_{line}$	-	0.05	0.2	%/V
Load Regulation ( $I_{out} = 1\text{ mA}$ to $300\text{ mA}$ , $V_{in} = V_{out} + 2.0\text{ V}$ )	$Reg_{load03}$	-15	-2	15	mV
Load Regulation ( $I_{out} = 1\text{ mA}$ to $1\text{ A}$ , $V_{in} = V_{out} + 2.0\text{ V}$ )	$Reg_{load1}$	-	-3	-	mV
Supply Current ( $I_{out} = 0\text{ A}$ , ( $V_{in} - V_{out}$ ) = $1\text{ V}$ , $V_{CE} = V_{in}$ )	$I_{ss}$		60	100	$\mu\text{A}$
Standby Current ( $V_{CE} = 0\text{V}$ , $V_{in} = 6.0\text{ V}$ )	$I_{stby}$		0.1	1.0	$\mu\text{A}$
Short Current Limit ( $V_{out} = 0\text{ V}$ )	$I_{sh}$		250		mA
Output Voltage Temperature Coefficient	$T_c$	-	$\pm 100$	-	ppm/ $^\circ\text{C}$
Enable Input Threshold Voltage (Voltage Increasing, Output Turns On, Logic High) (Voltage Decreasing, Output Turns Off, Logic Low)	$V_{thCE}$	1.0 0	- -	6 0.4	V
Enable Pull-down Current			100	220	nA
Drop Output Voltage ( $T_A = 25^\circ\text{C}$ , $I_{out} = 300\text{ mA}$ ) 0.8 V Output voltage $V_{out}$ (V) 1.0 V 1.2 V 2.5 V 3.3 V	$V_{in} - V_{out}$		0.33 0.22 0.18 0.10 0.05	0.570 0.470 0.320 0.150 0.100	V
Drop Output Voltage ( $T_A = 25^\circ\text{C}$ , $I_{out} = 1\text{ A}$ ) 0.8 V Output voltage $V_{out}$ (V) 1.0 V 1.2 V 2.5 V 3.3 V	$V_{in} - V_{out}$		0.72 0.64 0.56 0.32 0.18		V
Ripple Rejection (Ripple $200\text{ mV}_{pp}$ , $I_{out} = 100\text{ mA}$ , $f = 1\text{ kHz}$ )	PSRR		70		dB
Output Noise (BW = $10\text{ Hz}$ to $100\text{ kHz}$ , $I_{out} = 1\text{ mA}$ )	$V_{noise}$		30		$\mu\text{V}_{rms}$
Thermal Shutdown Temperature/Hysteresis	$T_{shd}/Hyst$		150/30		$^\circ\text{C}$
$R_{DS(on)}$ of additional output transistor (D version only)	$R_{DS(on)}$		30		$\Omega$

2. Maximum package power dissipation limits must be observed.
3. Low duty cycle pulse techniques are used during testing to maintain the junction temperature as close to ambient as possible.

# NCP694

**ELECTRICAL CHARACTERISTIC FOR ADJUSTABLE VERSION** ( $V_{in} = V_{out} + 1\text{ V}$ ,  $V_{CE} = V_{in}$ ,  $C_{in} = C_{out} = 4.7\ \mu\text{F}$ ,  $T_A = 25^\circ\text{C}$ , unless otherwise noted)

Characteristic	Symbol	Min	Typ	Max	Unit
Input Voltage	$V_{in}$	1.4		6	V
Supply Current ( $V_{out} = V_{ADJ}$ , $V_{in} = 2\text{ V}$ , $V_{CE} = V_{in}$ )	$I_{SS}$		60	100	$\mu\text{A}$
Standby Current ( $V_{in} = 6.0\text{ V}$ , $V_{CE} = 0\text{ V}$ )	$I_{standby}$		0.1	1	$\mu\text{A}$
Reference Voltage For Adjustable Voltage Regulator ( $V_{out} = V_{ADJ}$ , $V_{in} = 2.0\text{ V}$ , $I_{out} = 100\text{ mA}$ )	$V_{ref}$	0.97	1	1.03	V
Output Voltage Range	$V_{out\ range}$	1		$V_{in}$	V
Output Current ( $V_{out} = V_{ADJ}$ , $V_{in} = 2.0\text{ V}$ )	$I_{out}$	1			A
Load Regulation ( $V_{in} = 1.4\text{ V}$ , $1\text{ mA} < I_{out} < 300\text{ mA}$ , $V_{out} = V_{ADJ}$ )	$V_{out}/I_{out}$	-15	-2	15	mV
Load Regulation ( $V_{in} = 1.7\text{ V}$ , $1\text{ mA} < I_{out} < 1\text{ A}$ , $V_{out} = V_{ADJ}$ )	$V_{out}/I_{out}$		-3		mV
Dropout Voltage ( $V_{out} = V_{ADJ}$ , $I_{out} = 300\text{ mA}$ )	$V_{drop300}$		0.18	0.32	V
Dropout Voltage ( $V_{out} = V_{ADJ}$ , $I_{out} = 1\text{ A}$ )	$V_{drop1}$		0.56		V
Line regulation ( $V_{out} = V_{ADJ}$ , $I_{out} = 100\text{ mA}$ , $1.5\text{ V} < V_{in} < 6.0\text{ V}$ )	$V_{out}/V_{in}$		0.05	0.2	%V
PSRR ( $f = 1\text{ kHz}$ , $V_{out} = V_{ADJ}$ , $V_{in} = 2.5\text{ V}$ , $I_{out} = 100\text{ mA}$ , Input Ripple $0.5\text{ V}_{pp}$ )	PSRR		70		dB
Output Voltage Temperature Coefficient ( $I_{out} = 100\text{ mA}$ , $-40^\circ\text{C} < T_J < 85^\circ\text{C}$ )	$V_{out}/T_J$		$\pm 100$		ppm/ $^\circ\text{C}$
Short Current Limit ( $V_{out} = V_{ADJ} = 0$ )	$I_{lim}$		250		mA
Enable Pull-down Current	$I_{CE}$		100	220	nA
Enable Input Threshold Voltage (Voltage Increasing, Output Turns On, Logic High) (Voltage Decreasing, Output Turns Off, Logic Low)	$V_{thCE}$	1 0	- -	6 0.4	V
Thermal Shutdown Temperature/Hysteresis	$T_{shdn}/$ Hyst		150/ 30		$^\circ\text{C}$
$R_{DS(on)}$ of additional output transistor (D version only)	$R_{DS(on)}$		30		$\Omega$

APPLICATIONS INFORMATION

A typical application circuit for the NCP694 series is shown in Figure 5, Typical Application Schematic.

**Input Decoupling (C1)**

A 4.7 μF capacitor either ceramic or tantalum is recommended and should be connected as close as possible to the pins of NCP694 device. Higher values and lower ESR will improve the overall line transient response.

**Output Decoupling (C2)**

The minimum decoupling value is 4.7 μF and can be augmented to fulfill stringent load transient requirements. The regulator accepts ceramic chip capacitors as well as tantalum devices. If a tantalum capacitor is used, and its ESR is large, the loop oscillation may result. Because of this, select C2 carefully considering its frequency characteristics. Larger values improve noise rejection and load regulation transient response.

**Enable Operation**

The enable pin CE will turn on or off the regulator. These limits of threshold are covered in the electrical specification section of this data sheet. If the enable is not used then the pin should be connected to V<sub>in</sub>. The D version devices (NCP694DxxxxT1G) have additional circuitry in order to reach the turn-off speed faster than normal type. When the mode is into standby with CE signal, auto discharge transistor turns on.

**Hints**

Please be sure the V<sub>in</sub> and GND lines are sufficiently wide. If their impedance is high, noise pickup or unstable operation may result.

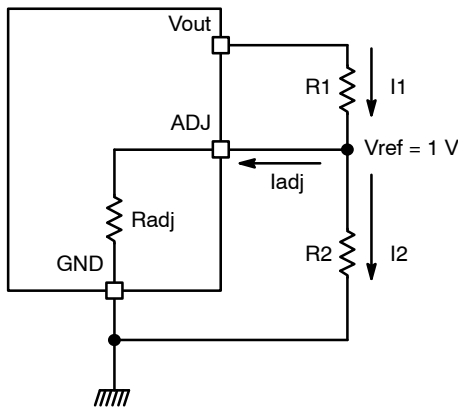

Figure 3. Output Voltage Setting

Set external components, especially the output capacitor, as close as possible to the circuit, and make leads as short as possible.

**Thermal**

As power across the NCP694 increases, it might become necessary to provide some thermal relief. The maximum power dissipation supported by the device is dependent upon board design and layout. Mounting pad configuration on the PCB, the board material, and also the ambient temperature effect the rate of temperature rise for the part. This is stating that when the NCP694 has good thermal conductivity through the PCB, the junction temperature will be relatively low with high power dissipation applications.

**Output Voltage Setting of Adjustable Version.**

An external two resistors are required for setting desired output voltage as shows Figure 3. Output Voltage Setting. The equation for the output voltage is mentioned in equation below.

$$\begin{aligned}
 V_{out} &= V_{ref} + R1 \cdot I1 \\
 &= V_{ref} + R1 \cdot (I_{adj} + I2) \\
 &= V_{ref} + R1 \cdot (V_{ref}/R_{adj}) + R1 \cdot (V_{ref}/R2) \quad (\text{eq. 1}) \\
 &= V_{ref} \cdot \left( 1 + (R1/R_{adj}) + (R1/R2) \right) \\
 &= 1.0 \cdot \left( 1 + (R1/R_{adj}) + (R1/R2) \right)
 \end{aligned}$$

For better accuracy, choosing R2 << R<sub>adj</sub> reduces the error given by ADJ pin consumption. The typical resistance R<sub>adj</sub> is showed in Figure 4. ADJ Pin Resistance

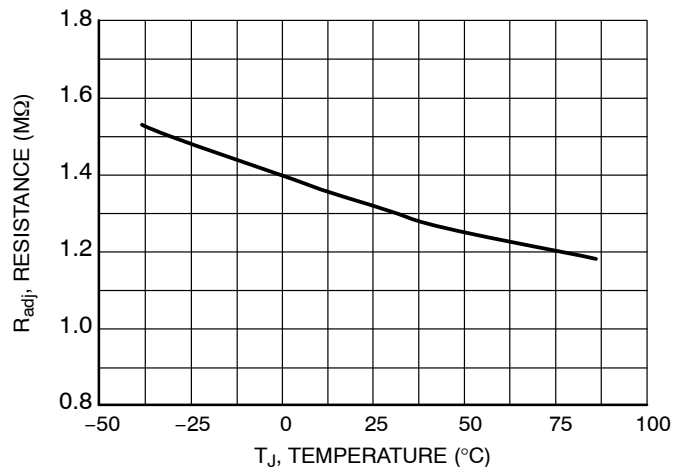

Figure 4. ADJ Pin Resistance vs. Temperature

# NCP694

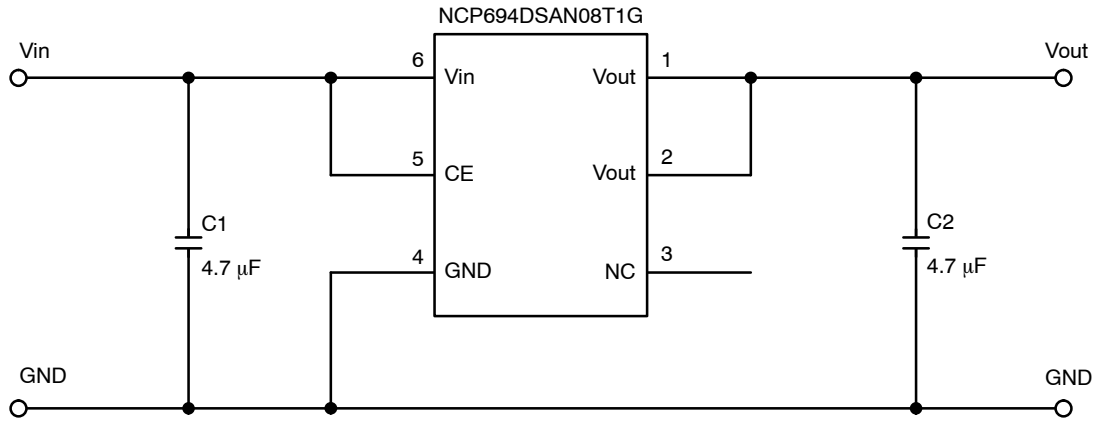

Figure 5. Typical Application Schematic

TYPICAL CHARACTERISTICS

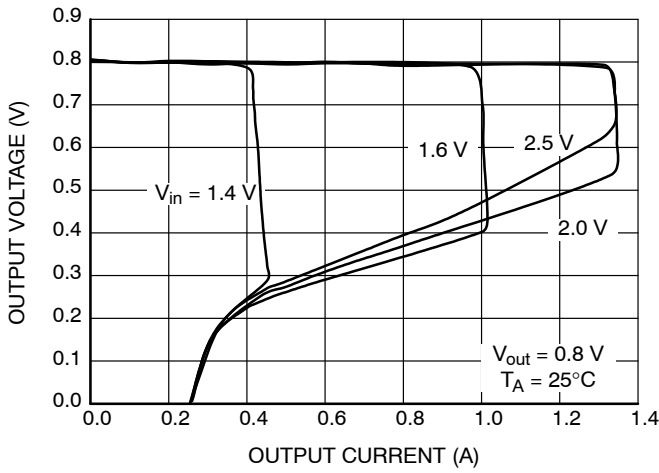

Figure 6. Output Voltage vs. Output Current

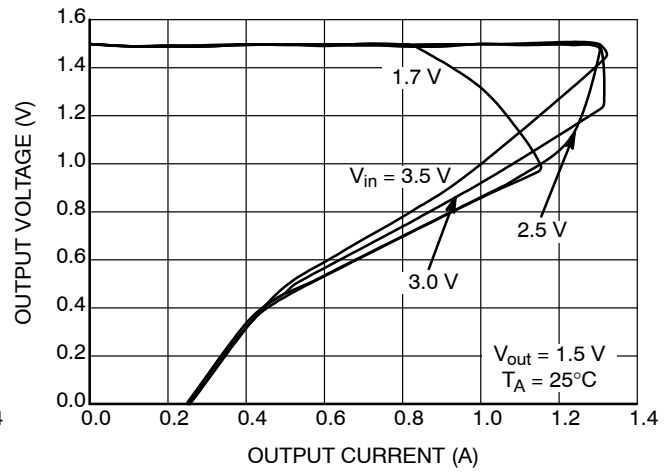

Figure 7. Output Voltage vs. Output Current

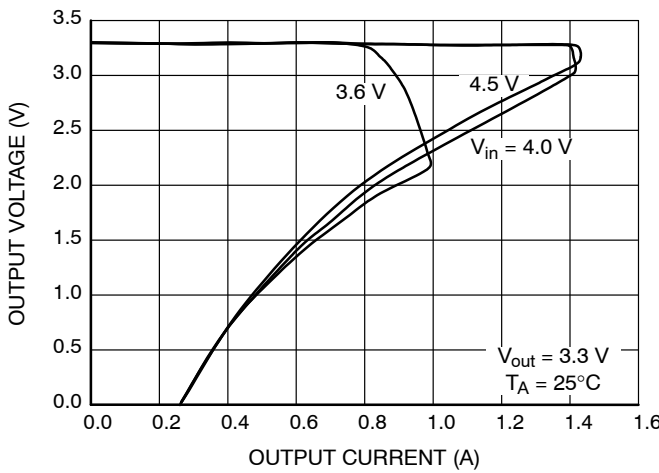

Figure 8. Output Voltage vs. Output Current

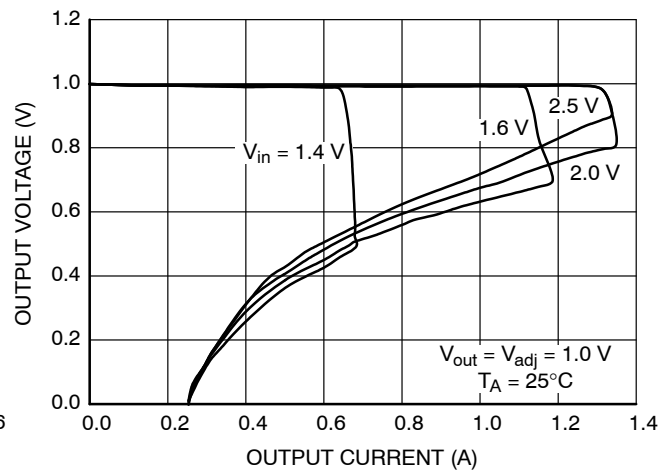

Figure 9. Output Voltage vs. Output Current for Adjustable Output

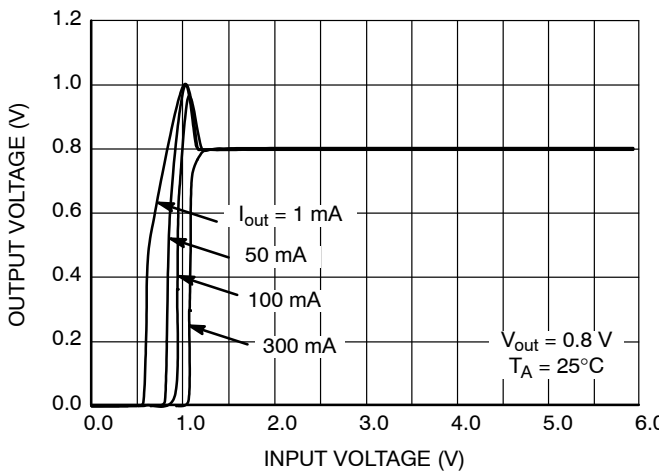

Figure 10. Output Voltage vs. Input Voltage

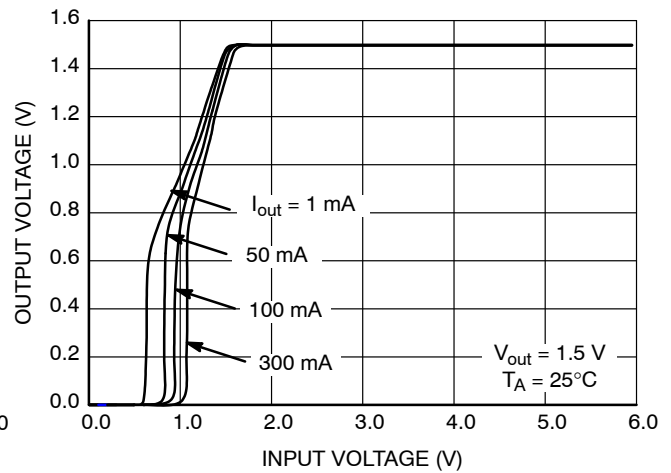

Figure 11. Output Voltage vs. Input Voltage

TYPICAL CHARACTERISTICS

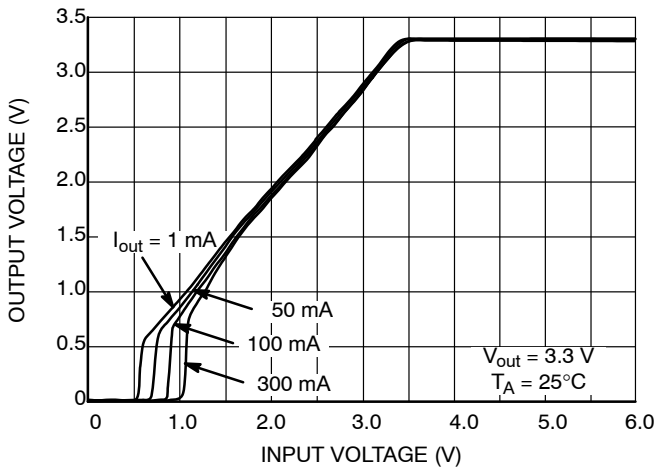

Figure 12. Output Voltage vs. Input Voltage

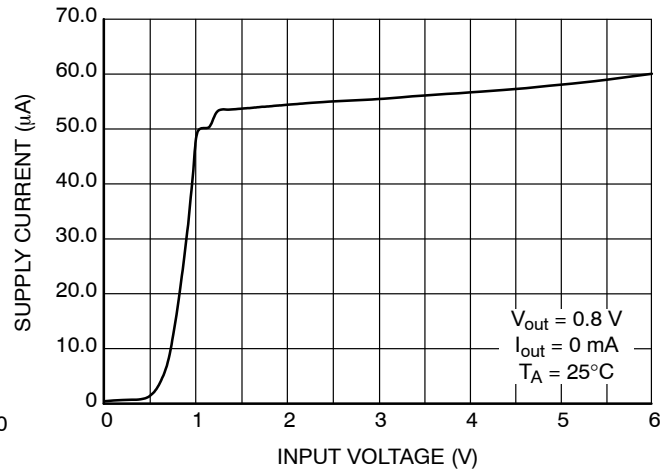

Figure 13. Supply Current vs. Input Voltage

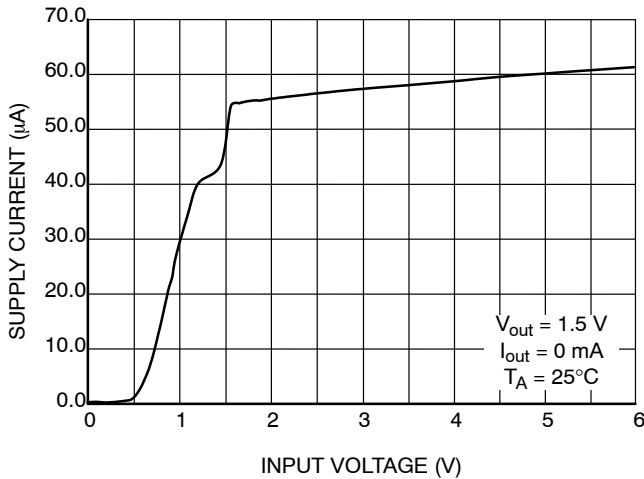

Figure 14. Supply Current vs. Input Voltage

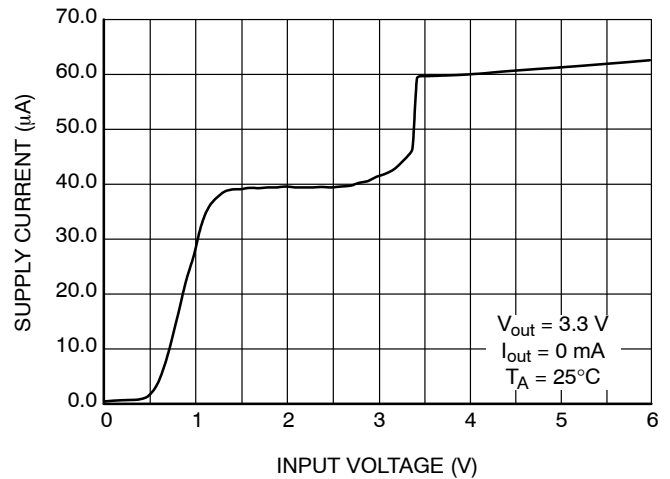

Figure 15. Supply Current vs. Input Voltage

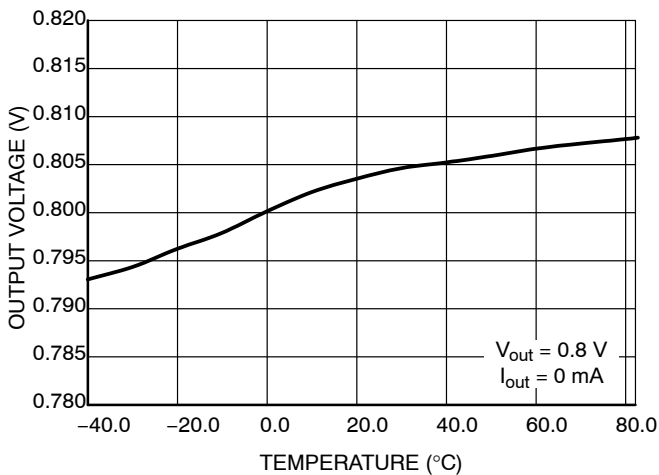

Figure 16. Output Voltage vs. Temperature

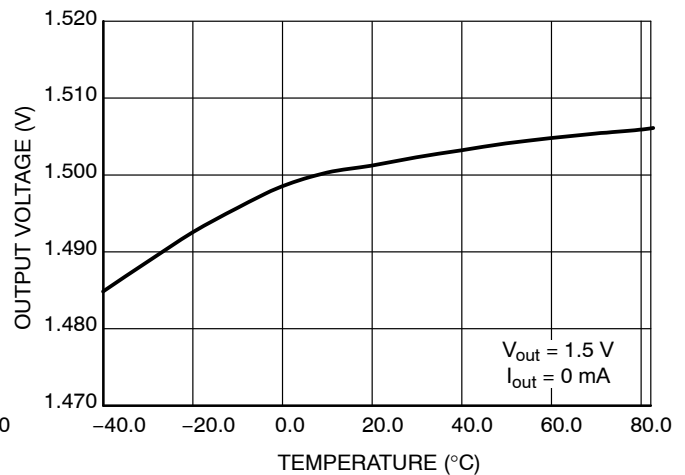

Figure 17. Output Voltage vs. Temperature

# NCP694

## TYPICAL CHARACTERISTICS

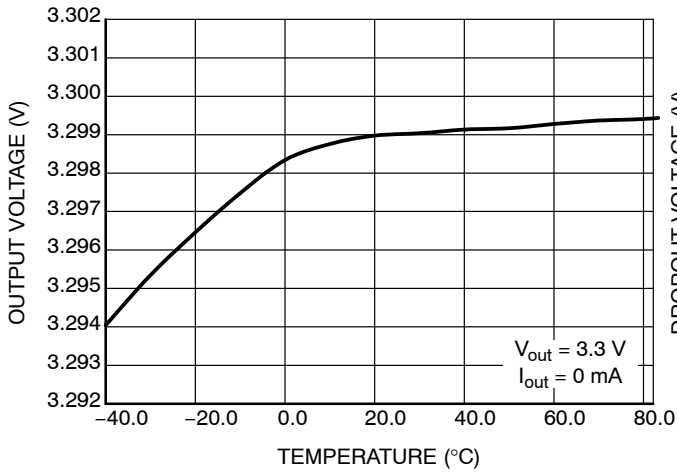

Figure 18. Output Voltage vs. Temperature

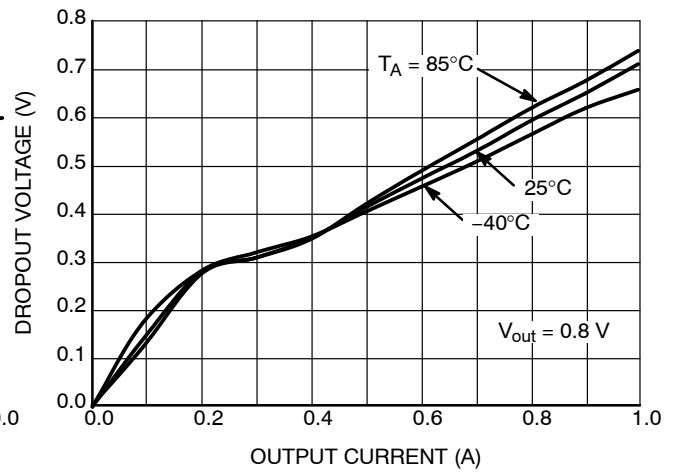

Figure 19. Dropout Voltage vs. Output Current

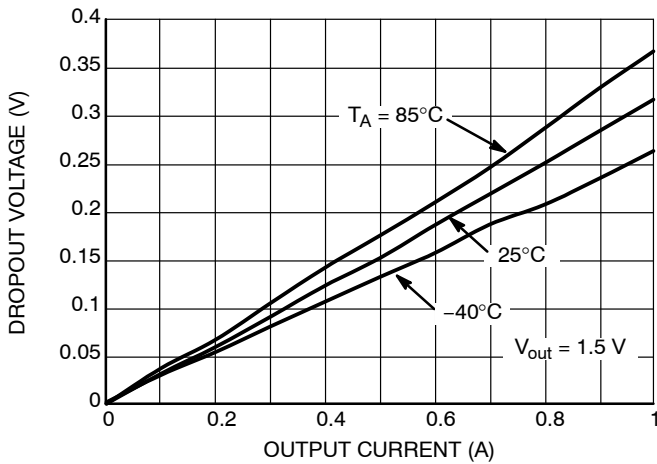

Figure 20. Dropout Voltage vs. Output Current

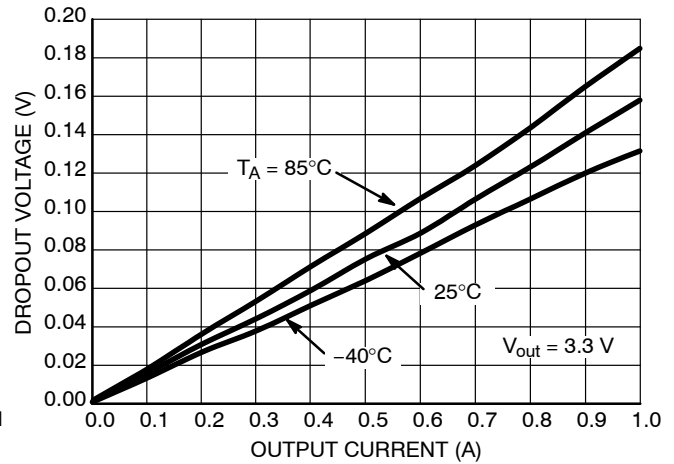

Figure 21. Dropout Voltage vs. Output Current

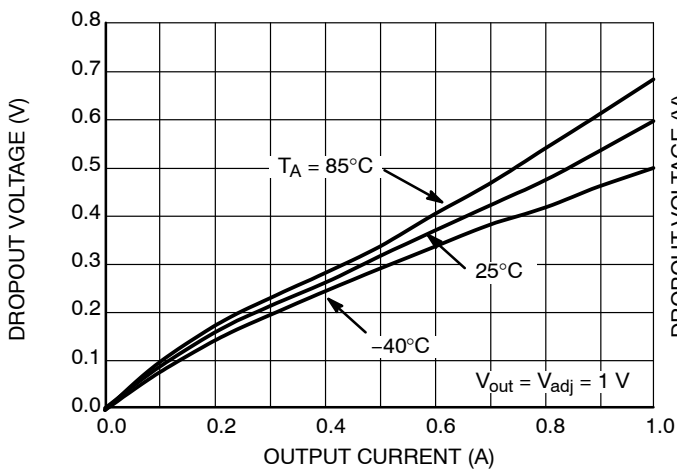

Figure 22. Dropout Voltage vs. Output Current for Adjustable Output

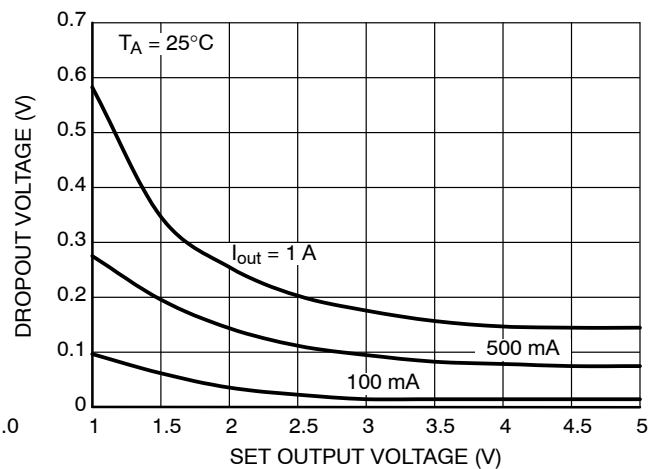

Figure 23. Dropout Voltage vs. Set Output Voltage

# NCP694

## TYPICAL CHARACTERISTICS

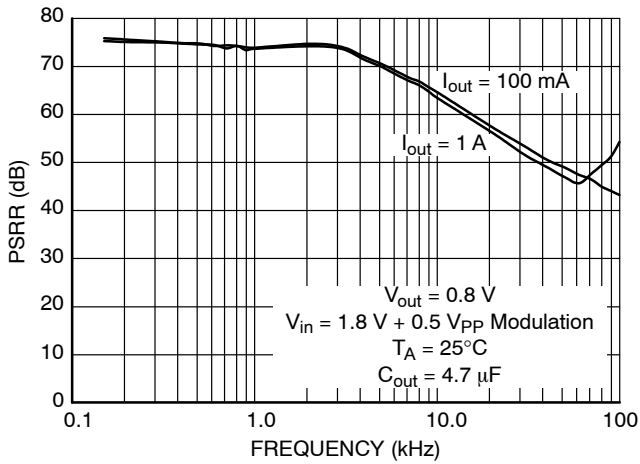

Figure 24. PSRR vs. Frequency

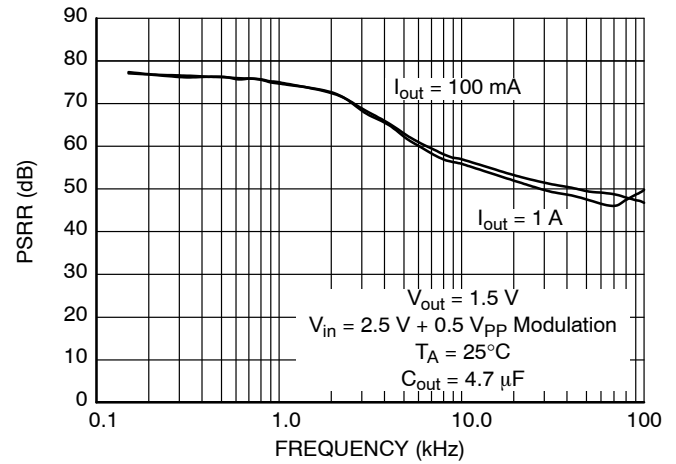

Figure 25. PSRR vs. Frequency

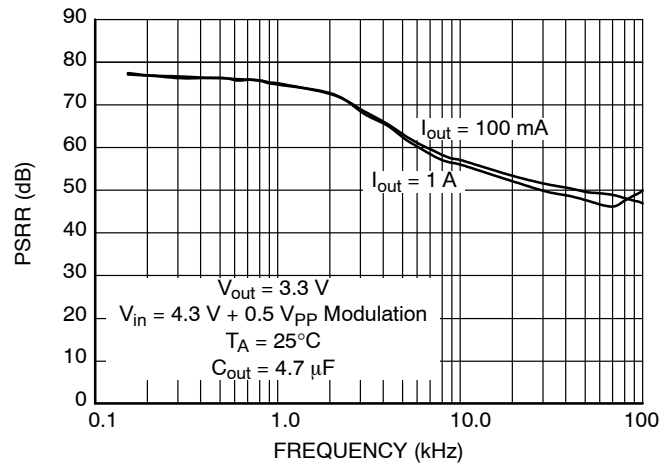

Figure 26. PSRR vs. Frequency

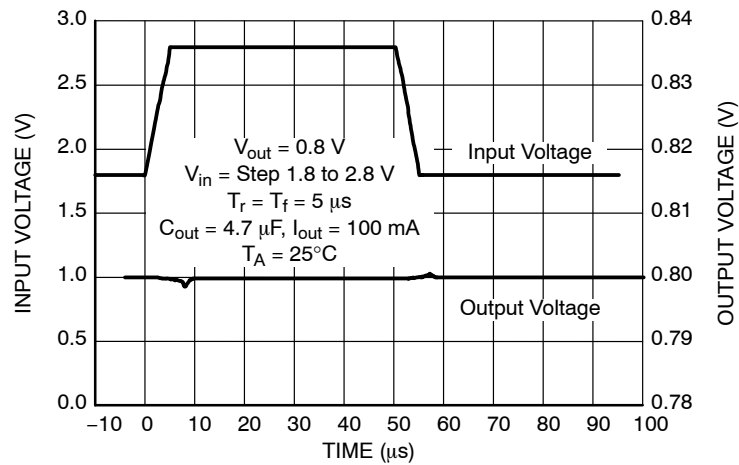

Figure 27. Line Transient Response

# NCP694

## TYPICAL CHARACTERISTICS

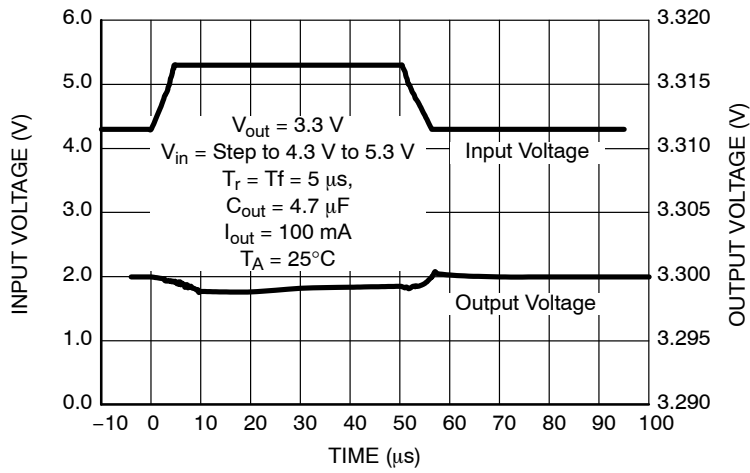

Figure 28. Input Transient Response

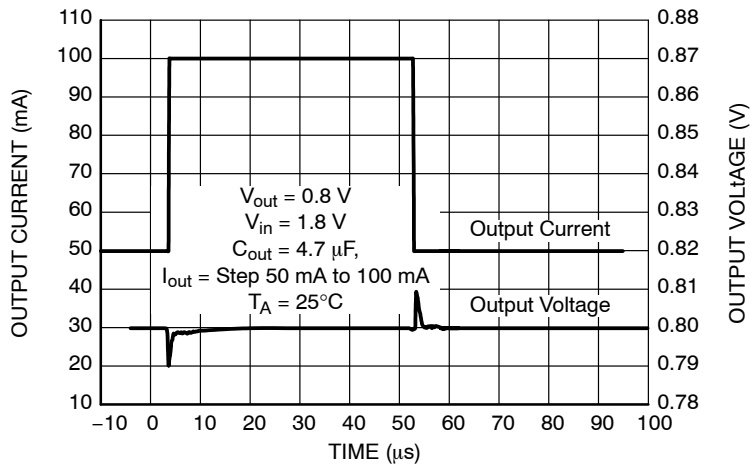

Figure 29. Load Transient Response

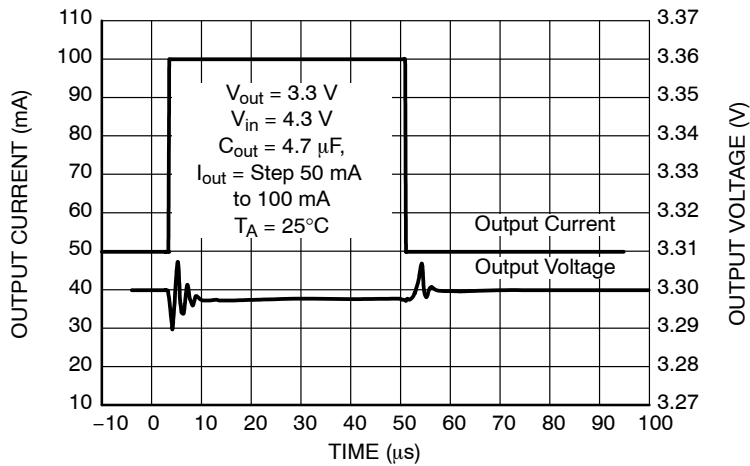

Figure 30. Load Transient Response

# NCP694

## TYPICAL CHARACTERISTICS

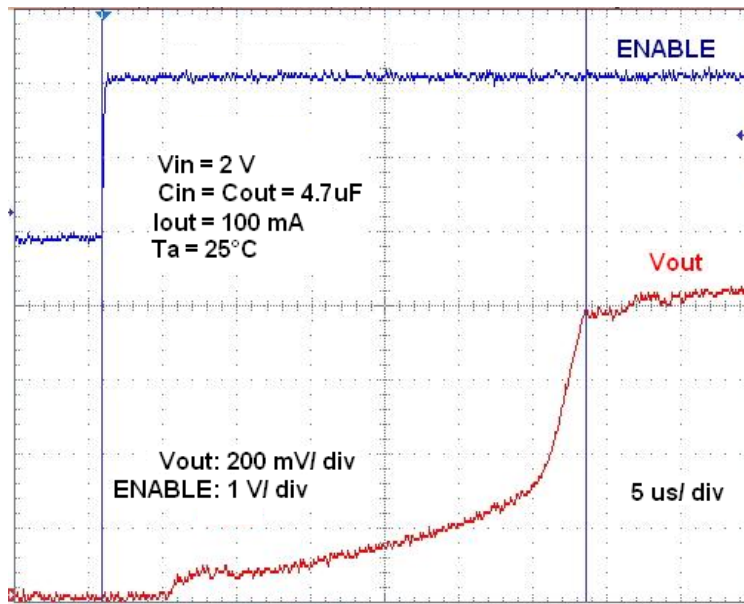

Figure 31. Output Voltage vs. CE Pin Turn-On NCP694Dx08xx

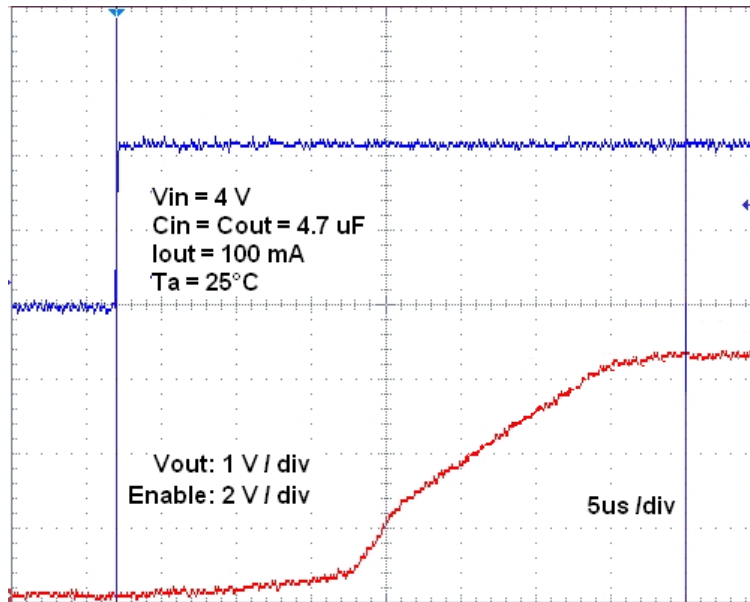

Figure 32. Output Voltage vs. CE Pin Turn-On NCP694Dx33xx

# NCP694

## TYPICAL CHARACTERISTICS

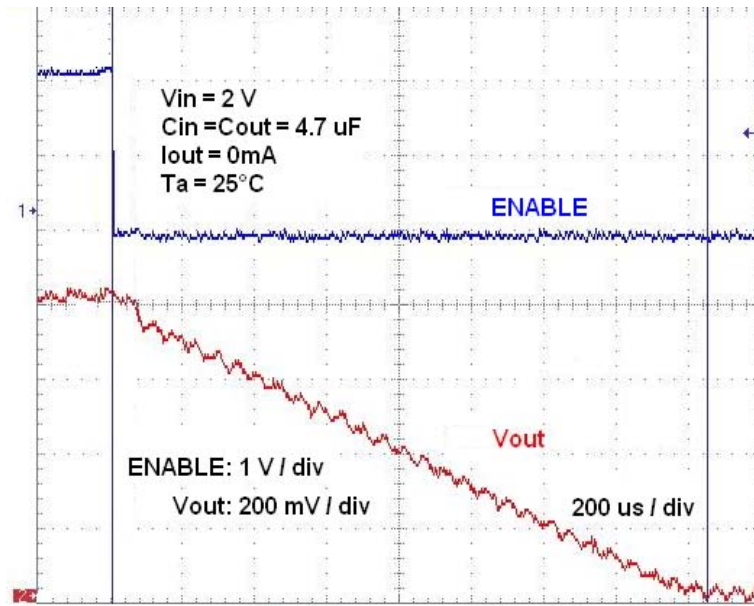

Figure 33. Output Voltage vs. CE Pin Turn-Off NCP694H08xxxx

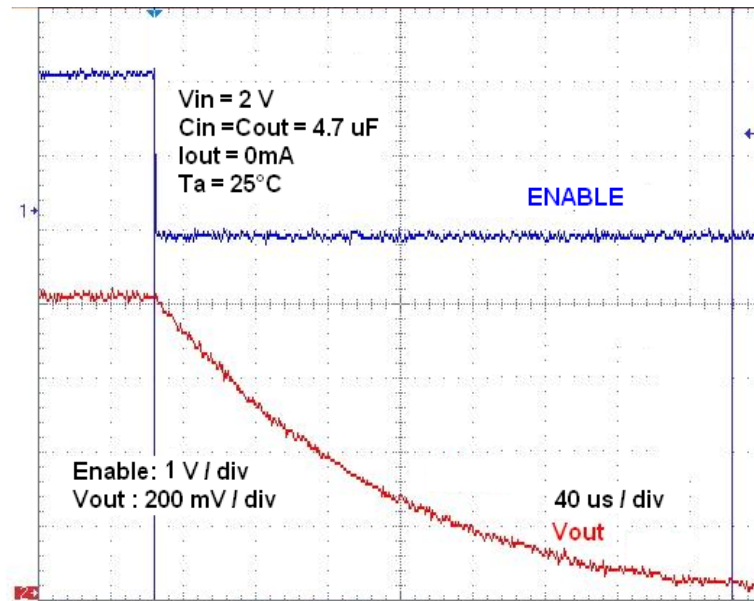

Figure 34. Output Voltage vs. CE Pin Turn-Off NCP694D08xxxx

# NCP694

## ORDERING INFORMATION

Device	Nominal Output Voltage	Description	Marking	Package	Shipping <sup>†</sup>
NCP694HADJHT1G	adj.	Enable High	L 0 0 B	SOT-89-5 (Pb-Free)	1000 / Tape & Reel
NCP694H08HT1G	0.8 V	Enable High	L 0 8 B	SOT-89-5 (Pb-Free)	1000 / Tape & Reel
NCP694H10HT1G	1.0 V	Enable High	L 1 0 B	SOT-89-5 (Pb-Free)	1000 / Tape & Reel
NCP694H12HT1G	1.2 V	Enable High	L 1 2 B	SOT-89-5 (Pb-Free)	1000 / Tape & Reel
NCP694H25HT1G	2.5 V	Enable High	L 2 5 B	SOT-89-5 (Pb-Free)	1000 / Tape & Reel
NCP694H33HT1G	3.3 V	Enable High	L 3 3 B	SOT-89-5 (Pb-Free)	1000 / Tape & Reel
NCP694DADJHT1G	adj.	Enable High - Auto discharge	L 0 0 D	SOT-89-5 (Pb-Free)	1000 / Tape & Reel
NCP694D08HT1G	0.8 V	Enable High - Auto discharge	L 0 8 D	SOT-89-5 (Pb-Free)	1000 / Tape & Reel
NCP694D10HT1G	1.0 V	Enable High - Auto discharge	L 1 0 D	SOT-89-5 (Pb-Free)	1000 / Tape & Reel
NCP694D12HT1G	1.2 V	Enable High - Auto discharge	L 1 2 D	SOT-89-5 (Pb-Free)	1000 / Tape & Reel
NCP694D25HT1G	2.5V	Enable High - Auto discharge	L 2 5 D	SOT-89-5 (Pb-Free)	1000 / Tape & Reel
NCP694D33HT1G	3.3 V	Enable High - Auto discharge	L 3 3 D	SOT-89-5 (Pb-Free)	1000 / Tape & Reel
NCP694HSANADJT1G	adj.	Enable High	H 0 0 B	HSO-6 (Pb-Free)	3000 / Tape & Reel
NCP694HSAN08T1G	0.8 V	Enable High	H 0 8 B	HSO-6 (Pb-Free)	3000 / Tape & Reel
NCP694HSAN10T1G	1.0 V	Enable High	H 1 0 B	HSO-6 (Pb-Free)	3000 / Tape & Reel
NCP694HSAN12T1G	1.2 V	Enable High	H 1 2 B	HSO-6 (Pb-Free)	3000 / Tape & Reel
NCP694HSAN25T1G	2.5 V	Enable High	H 2 5 B	HSO-6 (Pb-Free)	3000 / Tape & Reel
NCP694HSAN33T1G	3.3 V	Enable High	H 3 3 B	HSO-6 (Pb-Free)	3000 / Tape & Reel
NCP694DSANADJT1G	adj.	Enable High - Auto discharge	H 0 0 D	HSO-6 (Pb-Free)	3000 / Tape & Reel
NCP694DSAN08T1G	0.8 V	Enable High - Auto discharge	H 0 8 D	HSO-6 (Pb-Free)	3000 / Tape & Reel
NCP694DSAN10T1G	1.0 V	Enable High - Auto discharge	H 1 0 D	HSO-6 (Pb-Free)	3000 / Tape & Reel
NCP694DSAN12T1G	1.2 V	Enable High - Auto discharge	H 1 2 D	HSO-6 (Pb-Free)	3000 / Tape & Reel
NCP694DSAN25T1G	2.5 V	Enable High - Auto discharge	H 2 5 D	HSO-6 (Pb-Free)	3000 / Tape & Reel
NCP694DSAN33T1G	3.3 V	Enable High - Auto discharge	H 3 3 D	HSO-6 (Pb-Free)	3000 / Tape & Reel

<sup>†</sup>For information on tape and reel specifications, including part orientation and tape sizes, please refer to our Tape and Reel Packaging Specifications Brochure, BRD8011/D.

# NCP694

## PACKAGE DIMENSIONS

SOT-89, 5 LEAD  
CASE 528AB-01  
ISSUE O

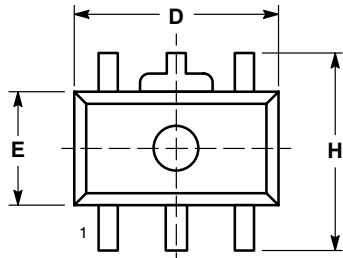

TOP VIEW

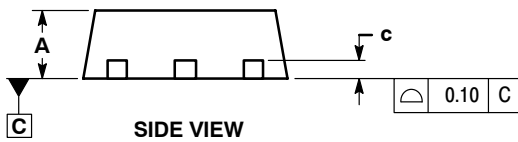

SIDE VIEW

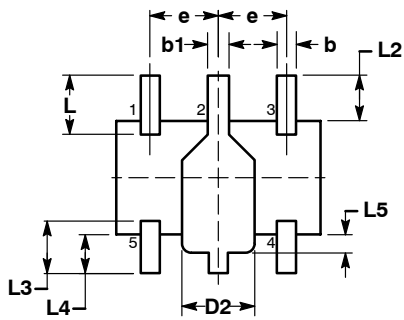

BOTTOM VIEW

NOTES:

1. DIMENSIONING AND TOLERANCING PER ASME Y14.5M, 1994.
2. CONTROLLING DIMENSION: MILLIMETERS.
3. LEAD THICKNESS INCLUDES LEAD FINISH.
4. DIMENSIONS D AND E DO NOT INCLUDE MOLD FLASH, PROTRUSIONS, OR GATE BURRS.
5. DIMENSIONS L, L2, L3, L4, L5, AND H ARE MEASURED AT DATUM PLANE C.

DIM	MILLIMETERS	
	MIN	MAX
A	1.40	1.60
b	0.32	0.52
b1	0.37	0.57
c	0.30	0.50
D	4.40	4.60
D2	1.40	1.80
E	2.40	2.60
e	1.40	1.60
H	4.25	4.45
L	1.10	1.50
L2	0.80	1.20
L3	0.95	1.35
L4	0.65	1.05
L5	0.20	0.60

### RECOMMENDED MOUNTING FOOTPRINT\*

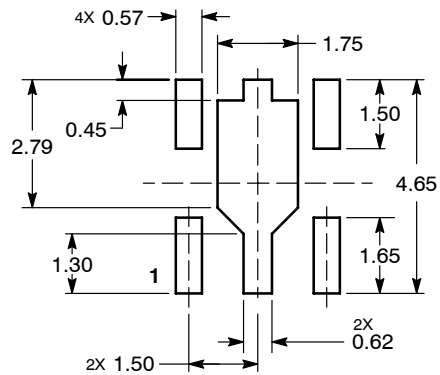

DIMENSIONS: MILLIMETERS

\*For additional information on our Pb-Free strategy and soldering details, please download the ON Semiconductor Soldering and Mounting Techniques Reference Manual, SOLDERRM/D.

# NCP694

## PACKAGE DIMENSIONS

HSO6-6  
CASE 506AE-01  
ISSUE A

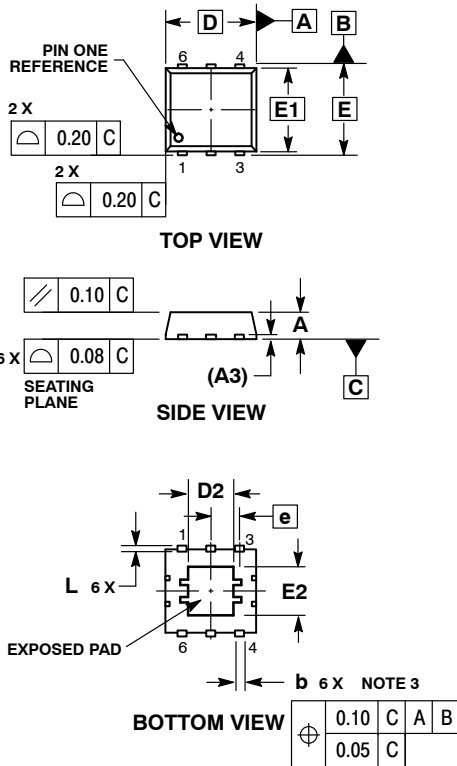

### NOTES:

1. DIMENSIONING AND TOLERANCING PER ASME Y14.5M, 1994.
2. CONTROLLING DIMENSION: MILLIMETERS.
3. DIMENSION b APPLIES TO PLATED TERMINAL AND IS MEASURED BETWEEN 0.10 AND 0.15 MM FROM TERMINAL.
4. COPLANARITY APPLIES TO THE EXPOSED PAD AS WELL AS THE TERMINALS.

DIM	MILLIMETERS	
	MIN	MAX
A	0.70	0.90
A3	0.15	REF
b	0.20	0.40
D	2.90	BSC
D2	1.40	1.60
E	3.00	BSC
E1	2.80	BSC
E2	1.50	1.70
e	0.95	BSC
L	0.15	0.25

ON Semiconductor and are registered trademarks of Semiconductor Components Industries, LLC (SCILLC). SCILLC reserves the right to make changes without further notice to any products herein. SCILLC makes no warranty, representation or guarantee regarding the suitability of its products for any particular purpose, nor does SCILLC assume any liability arising out of the application or use of any product or circuit, and specifically disclaims any and all liability, including without limitation special, consequential or incidental damages. "Typical" parameters which may be provided in SCILLC data sheets and/or specifications can and do vary in different applications and actual performance may vary over time. All operating parameters, including "Typicals" must be validated for each customer application by customer's technical experts. SCILLC does not convey any license under its patent rights nor the rights of others. SCILLC products are not designed, intended, or authorized for use as components in systems intended for surgical implant into the body, or other applications intended to support or sustain life, or for any other application in which the failure of the SCILLC product could create a situation where personal injury or death may occur. Should Buyer purchase or use SCILLC products for any such unintended or unauthorized application, Buyer shall indemnify and hold SCILLC and its officers, employees, subsidiaries, affiliates, and distributors harmless against all claims, costs, damages, and expenses, and reasonable attorney fees arising out of, directly or indirectly, any claim of personal injury or death associated with such unintended or unauthorized use, even if such claim alleges that SCILLC was negligent regarding the design or manufacture of the part. SCILLC is an Equal Opportunity/Affirmative Action Employer. This literature is subject to all applicable copyright laws and is not for resale in any manner.

### PUBLICATION ORDERING INFORMATION

**LITERATURE FULFILLMENT:**  
Literature Distribution Center for ON Semiconductor  
P.O. Box 5163, Denver, Colorado 80217 USA  
**Phone:** 303-675-2175 or 800-344-3860 Toll Free USA/Canada  
**Fax:** 303-675-2176 or 800-344-3867 Toll Free USA/Canada  
**Email:** orderlit@onsemi.com

**N. American Technical Support:** 800-282-9855 Toll Free  
USA/Canada  
**Europe, Middle East and Africa Technical Support:**  
Phone: 421 33 790 2910  
**Japan Customer Focus Center**  
Phone: 81-3-5773-3850

**ON Semiconductor Website:** [www.onsemi.com](http://www.onsemi.com)  
**Order Literature:** <http://www.onsemi.com/orderlit>  
For additional information, please contact your local Sales Representative

## Looking for pricing, stock, or lifecycle information?

Click below to explore more details on WIN SOURCE:

- ⊖ [View NCP694HSAN12T1G on WIN SOURCE](#)
- ⊖ [ON Semiconductor Information](#)

## Optimize Your Supply Chain with WIN SOURCE Solutions

- ✓ Global Sourcing Solution
- ✓ Obsolete Management
- ✓ Cost Control Management
- ✓ Shortage Management
- ✓ Alternative Solution
- ✓ Excess Inventory Management