



**THE DATASHEET OF  
SL3732A-R12KHF**



## 1. Features of SL3732 Series:

- Ferrite based SMD inductor with lower core loss.
- Inductance range: 70.0 nH to 510.0 nH , custom values are welcomed.
- High current output chokes , up to 132.0 Amp with approx. 20% roll off.
- Low profile 8.00mm Max. Height.
- 9.60 x 6.40 mm Foot Print.
- Ideal for Buck Converter, VRM & High Density Board Design.
- Operating frequency of up to 5.0MHz.
- Operating temperature range of -55° C to + 130° C.
- RoHS & HF compliant.
- T & R Qty's: 650pcs, 13" Reel.



## 2. Electrical Characteristics of SL3732 Series:

ITG Part Number	OCL <sup>1</sup> (nH)	DCR <sup>3</sup> (mΩ)	Isat1 <sup>4</sup> (A)	Isat2 <sup>4</sup> (A)	Irms <sup>5</sup> (A)	Fig
	± 10% or 15%	± 5.0%	@25°C	@100°C	@25°C	
SL3732A-R07LHF	70.00 , 15%	0.29	132.00	100.00	51.00	1
SL3732A-R10KHF	100.00 , 10%	0.29	95.00	85.00	51.00	1
SL3732A-R12KHF	120.00 , 10%	0.29	80.00	70.00	51.00	1
SL3732A-R15KHF	150.00 , 10%	0.29	67.00	57.00	51.00	1
SL3732A-R18KHF	180.00 , 10%	0.29	47.00	42.00	51.00	1
SL3732A-R22KHF	220.00 , 10%	0.29	43.00	34.00	51.00	1
SL3732A-R28KHF	280.00 , 10%	0.29	29.00	24.00	51.00	1
SL3732A-R30KHF	300.00 , 10%	0.29	28.00	23.00	51.00	1
SL3732A-R40LHF	400.00 , 15%	0.29	18.00	15.00	51.00	1
SL3732A-R51LHF	510.00 , 15%	0.29	14.00	11.00	51.00	1
SL3732C-R12KHF	120.00 , 10%	0.29	75.00	62.00	51.00	2
SL3732C-R15KHF	150.00 , 10%	0.29	66.00	55.00	51.00	2
SL3732C-R22KHF	220.00 , 10%	0.29	40.00	31.00	51.00	2
SL3732C-R28KHF	280.00 , 10%	0.29	27.00	21.00	51.00	2
SL3732C-R30KHF	300.00 , 10%	0.29	25.00	20.00	51.00	2

## 3. Mechanical Dimension of SL3732 Series:

A	B	C	D	E	F	G	H	Fig
± 0.20	(Max.)	± 0.20	± 0.20	Ref.	± 0.20	± 0.30	(Ref.)	
6.20	9.50	7.80	9.40	4.40	2.20	2.50		1
6.20	9.50	7.80	9.40	4.40	2.20	2.50	0.70	2

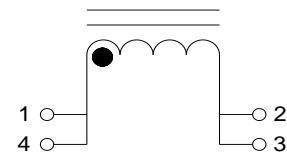

SCHMATIC DIAGRAM

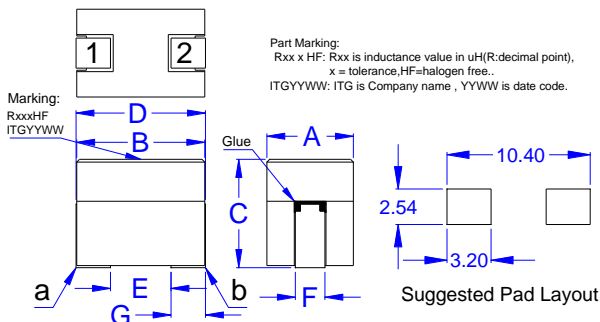

Fig 1

First Angle Projection:

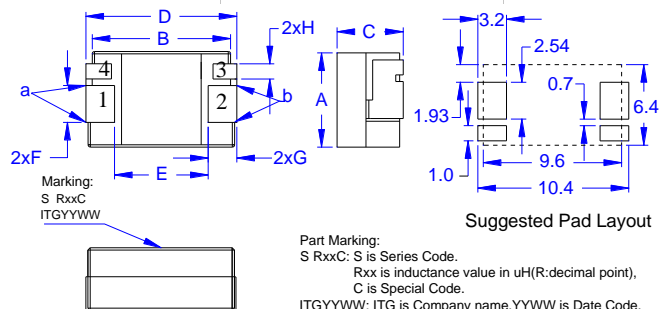
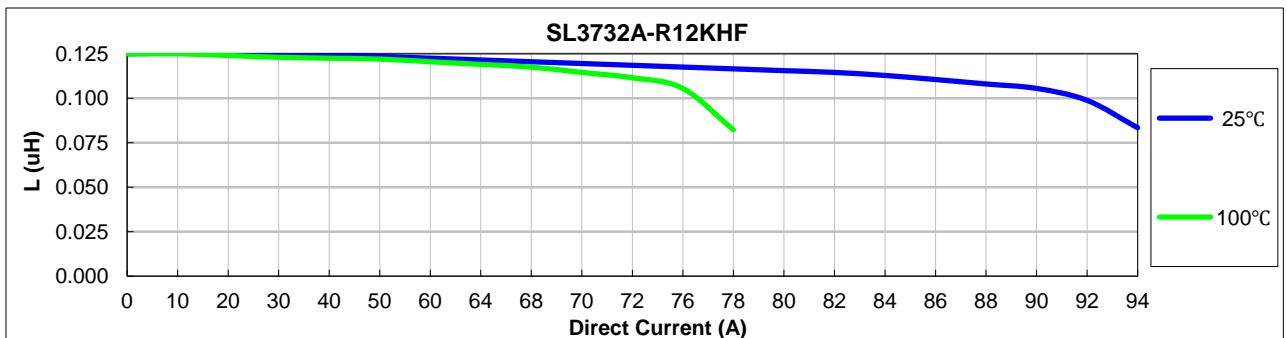
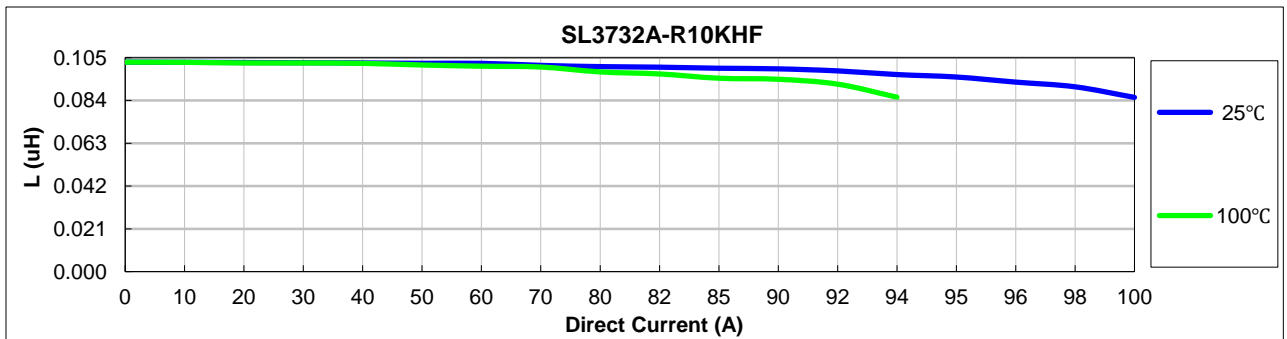
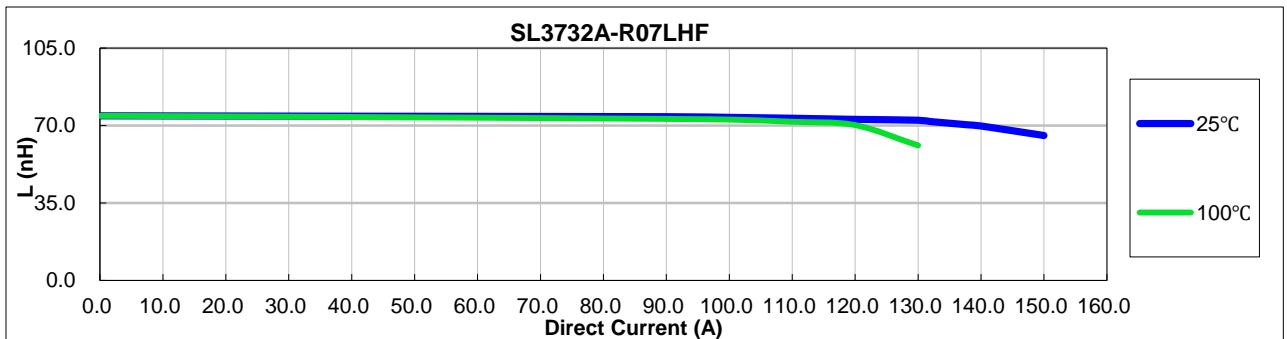

Fig 2

**Notes:**

1. Open Circuit Inductance (OCL) test condition: 100KHz , 1Vrms , 0Adc at 25°C.
2. L @ Isat and L @ Irms Test condition: 100KHz , 1Vrms (Ta=25°C).
3. The nominal DCR is measured from point "a" to point "b", as shown above on the mechanical drawing (Ta=25°C).
4. Isat1 , Isat2 : DC current that will cause inductance to drop approximately by 20%.
5. Irms: DC current for an approximate temperature rise of 40°C without core loss. Derating is necessary for AC currents. PCB pad layout, trace thickness and width , air-flow and proximity of other heat generating components will affect the temperature rise.
6. It is recommended the part temperature not exceed 130° C under worst case operating conditions as verified in the end application.

**4. Inductance Characteristics of SL3732 Series (Inductance vs Current):**





# SL3732 Series



## 4. Inductance Characteristics of SL3732 Series (Inductance vs Current):

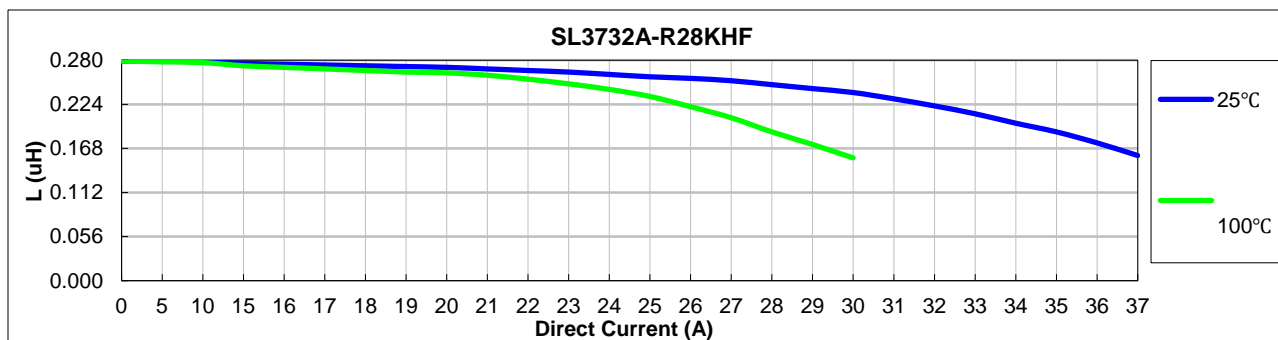
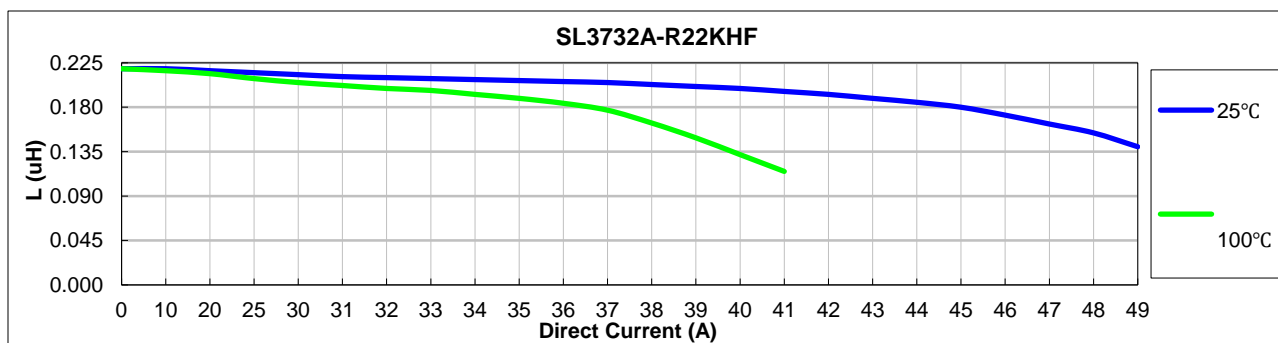
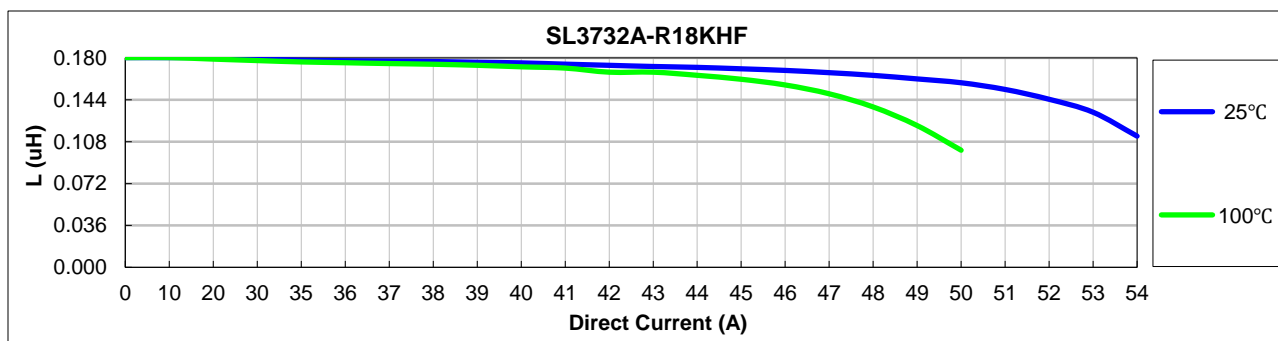
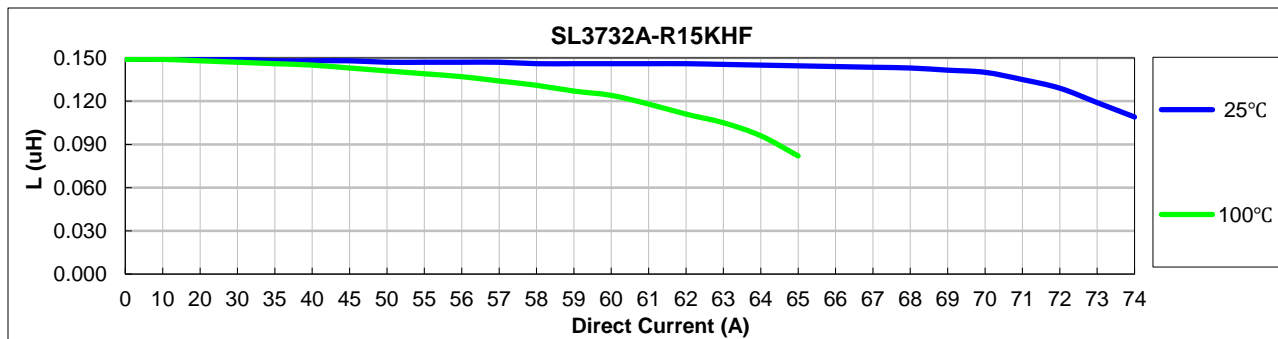

## 4. Inductance Characteristics of SL3732 Series (Inductance vs Current):

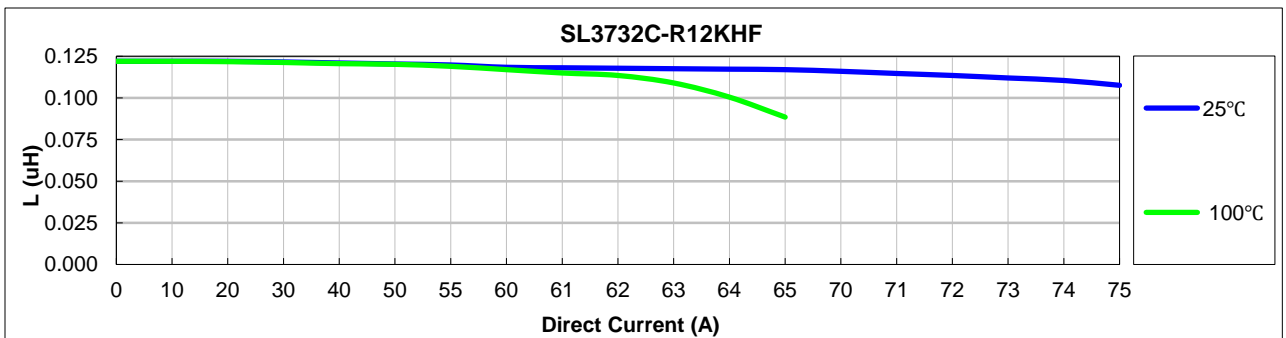
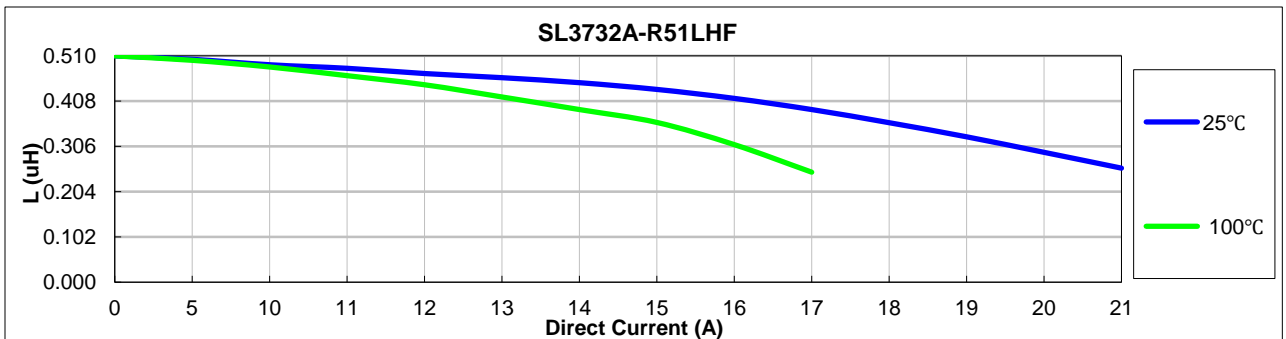
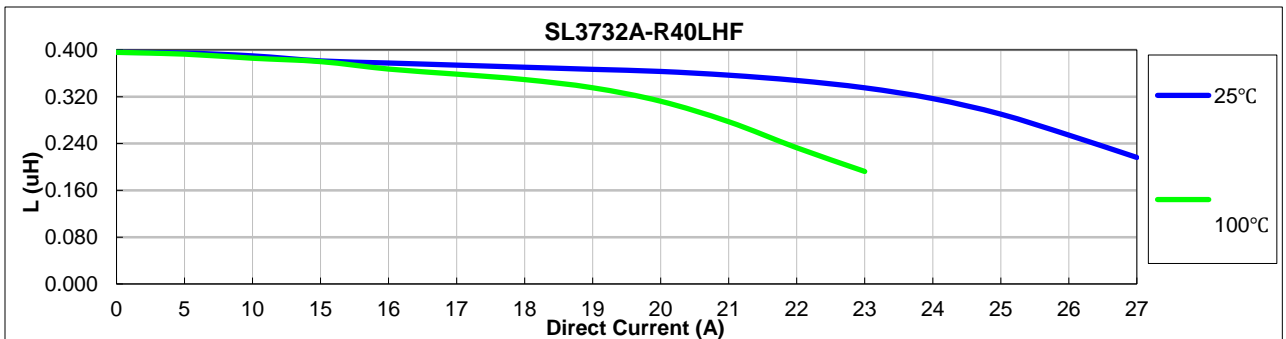
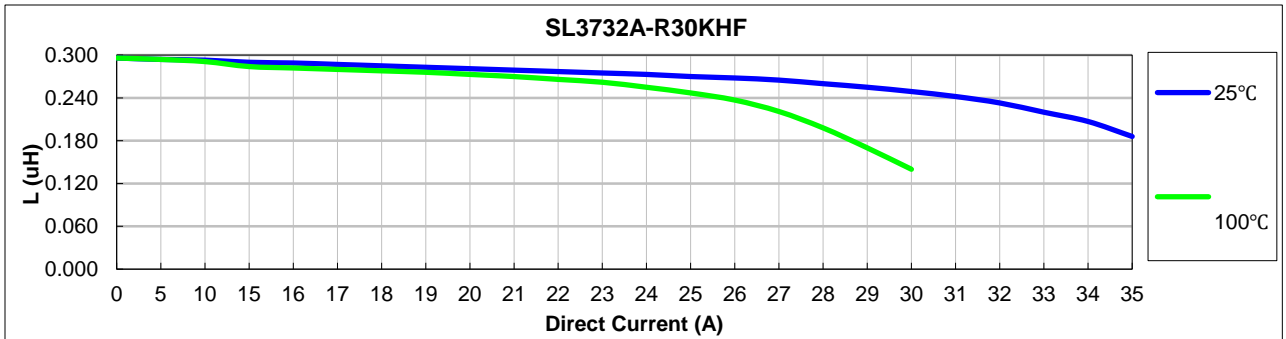

## 4. Inductance Characteristics of SL3732 Series (Inductance vs Current):

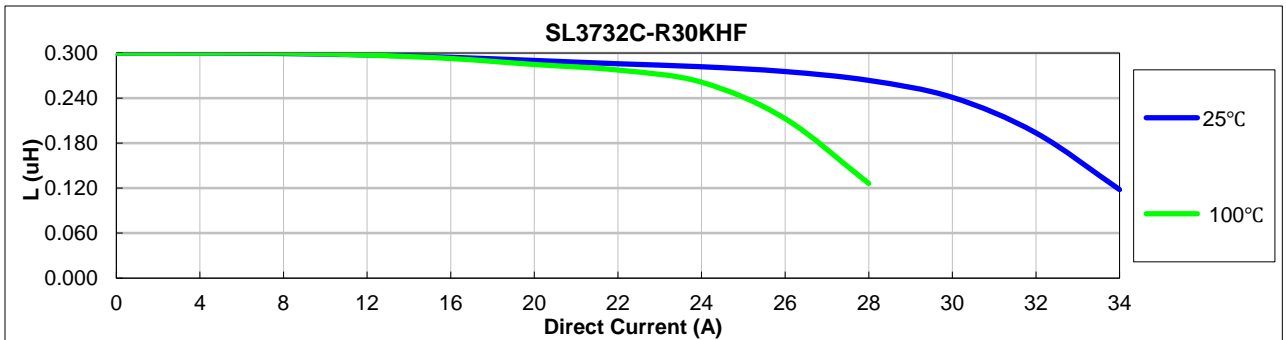
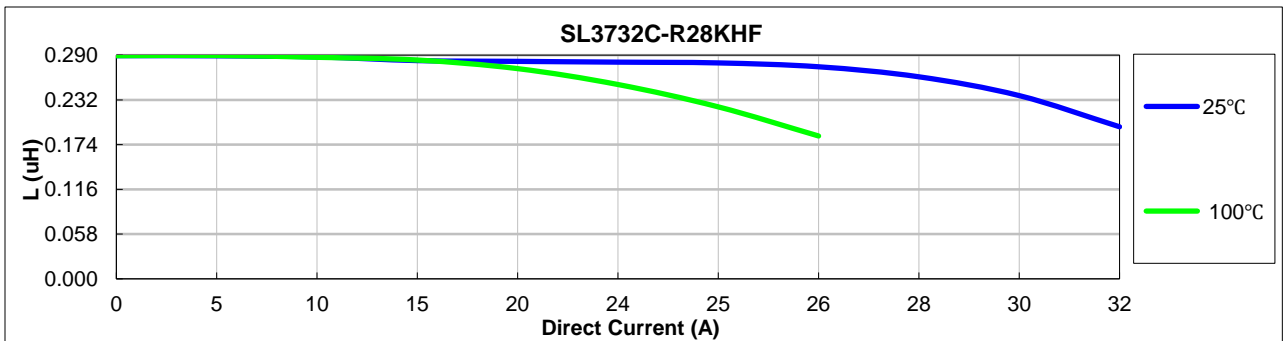
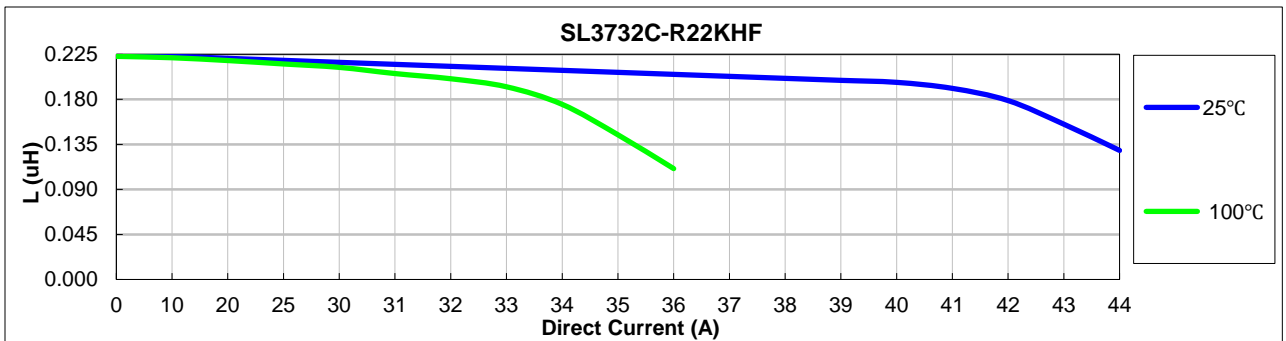
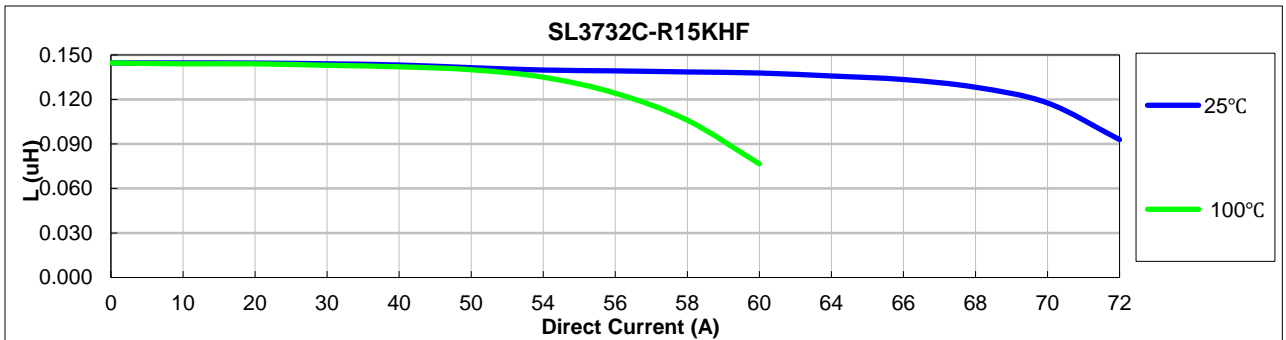



## 5. Core Loss:

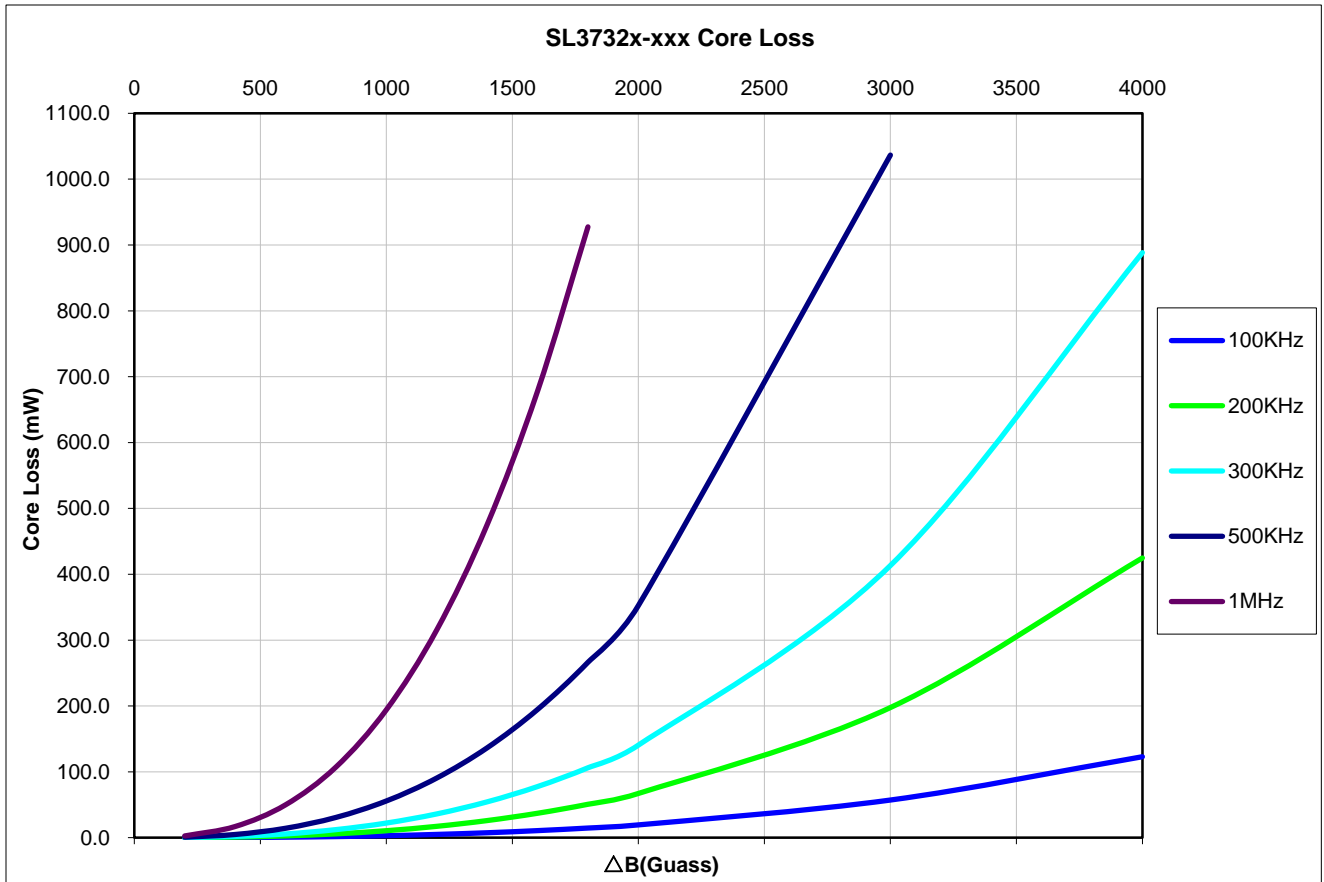

Where  $\Delta B = 0.40 * L(nH) * \Delta I$

## 6. PACKAGE SPECIFICATION.(UNIT:mm):

### (1).ENCAPSULATION MODE:

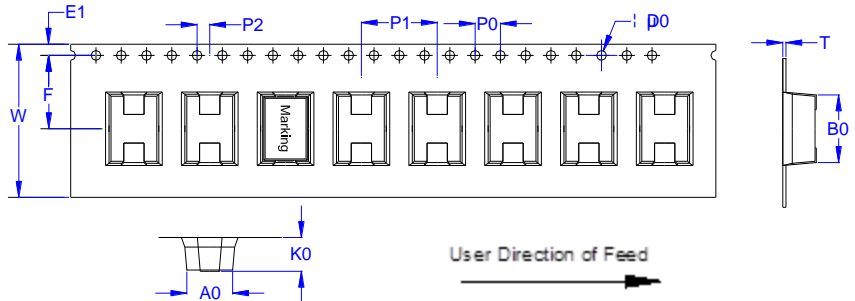

### (2).DIMENSION(mm):

W	A0	B0	K0	P0	P1	P2	D0	E1	F	T
24.00+0.30/-0.10	6.60±0.10	9.70±0.10	8.30±0.10	4.00±0.10	12.00±0.10	2.00±0.10	1.50+0.10/-0	1.750±0.10	11.50±0.10	0.50±0.05

### (3).REEL SIZE:

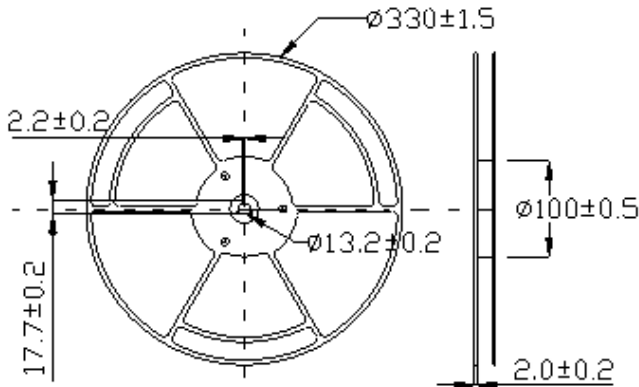

### (4).PACKAGE MODE:

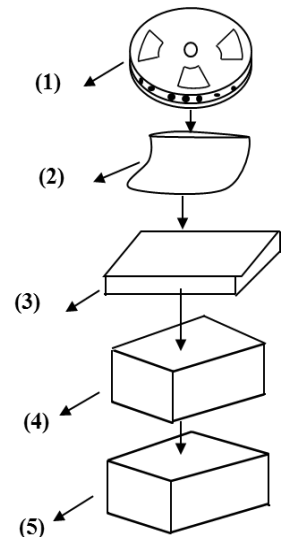

### (5).PACKAGING LIST:

No.	Packing Part	Dimension (mm)	Material	Quantity
1	Reel	330	Plastic	650Pcs/Reel
2	Bag	450x360x0.075	Plastic	1Reel/Bag
3	Small Box	340X335X45	Paper	1Bag/Small Box
4	Middle Box	356X350X226	Paper	4Small Boxes/Middle Box
5	Outer Box	378X362X252	Paper	1Middle Box/Outer Box

### (6).WEIGHT: N.W: 2.10g/pcs TOTAL5.46Kg(APPROX),G.W:TOTAL11.06Kg(APPROX).

### (7).Storage conditions: -40°C~85°C ,75%RH (Max.).

# SL3732C Series



## 6. PACKAGE SPECIFICATION.(UNIT:mm):

### (1).ENCAPSULATION MODE:

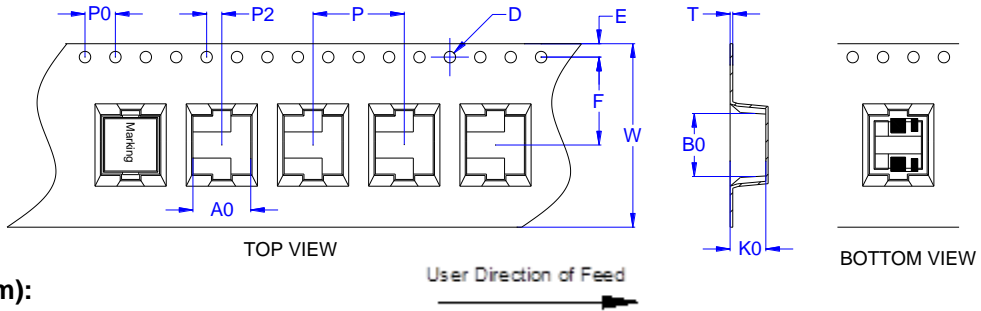

### (2).DIMENSION(mm):

W	A0	B0	K0	P0	P1	P2	D0	E1	F	T
24.00+0.30/-0.10	6.60±0.10	9.70±0.10	8.30±0.10	4.00±0.10	12.00±0.10	2.00±0.10	1.50+0.10/-0	1.750±0.10	11.50±0.10	0.50±0.05

### (3).REEL SIZE:

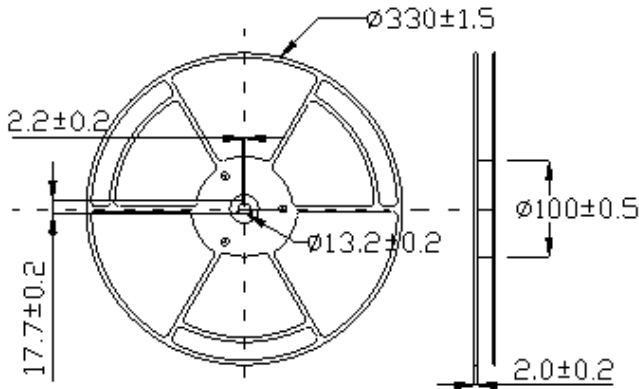

### (4).PACKAGE MODE:

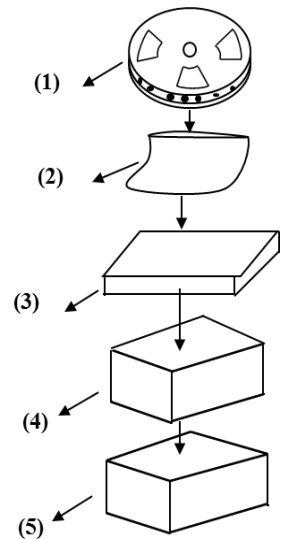

### (5).PACKAGING LIST:

No.	Packing Part	Dimension (mm)	Material	Quantity
1	Reel	330	Plastic	650Pcs/Reel
2	Bag	450x360x0.075	Plastic	1Reel/Bag
3	Small Box	340X335X45	Paper	1Bag/Small Box
4	Middle Box	356X350X226	Paper	4Small Boxes/Middle Box
5	Outer Box	378X362X252	Paper	1Middle Box/Outer Box

### (6).WEIGHT: N.W: 2.15g/pcs TOTAL5.59Kg(APPROX),G.W:TOTAL11.19Kg(APPROX).

### (7).Storage conditions: -40°C~85°C ,75%RH (Max.).



Halogen Free

# SL3732 Series



## 7.RELIABILITY TEST:

TEST ITEMS	SPECIFICATIONS	TEST METHOD AND REMARKS
Solder ability	The electrodes shall be at least 90% covered with new solder coating	According to IEC68-2-20. 1. Soldering temperature:245±5°C 2. Solder:99.3Sn/0.7Cu 3. Flux:Rosin 4. Immersion time:5±1Sec
Soldering heat resistance	1. Appearance :no damage 2. Inductance change:within±10%of initial value	1. Preheat temperature150°C. 2. Preheat time:1min 3. Solder temperature260±5°C 4. Dipping time:10±1Sec 5. Measured at room temperature after placing for 24hours
Vibration( OUT LAB)	1. Appearance:no damage 2. All Electrical and mechanical parameters within tolerance	According to MIL-STD-202G Method 201A. 1.Frequency:10 to 55Hz. 2.Amplitude:1.52mm 3.Direction and timeX Y and Z Direction for 2 hours each
Humidity resistance test	1. Appearance: no damage 2. All Electrical and mechanical parameters within tolerance	According to IEC68-2-1MethodCa: 1. Temp:40±2°C 2. Humidity:90%-95%RH 3. Test time:500±2H 4. The component should be stabilized at normal condition for24 Hours before test
High temperature resistance test	1. Appearance: no damage 2. All Electrical and mechanical parameters within tolerance	According to IEC68-2-2. 1. 1. Temperature:85±3°C 2. Test time:500+24H 3. The component should be stabilized at normal condition for 24hours before test
Low Temperature resistance test	1. Appearance: no damage 2. All Electrical and mechanical parameters within tolerance	According to IEC68-2-1 Method A(Ad). 1. Temperature:-40±3°C 2. Test time:500+24H 3. The component should be stabilized at normal condition for 24hours before test
Temperature cycles test	1. Appearance: no damage 2. All Electrical and mechanical parameters within tolerance	According to IEC68-2-14 Method N(Nb). 1. High-temp:85±3duration:30min 2. room -temp:25±2°CDuration3H 3. Low-temp:-40±3Duration30min 4. room-temp: 25±2°CDuration3H 5. Number of cycle:10cycles 6. The component should be stabilized at normal condition for 24hours before test

● New York 1 914 347 2474 ● Taipei 886 2 2698 8669 ● Kaohsiung 886 7 350 2275  
 ● Japan 81 568 85 2830 ● Shenzhen 86 755 8418 6263 ● Shanghai 86 21 5424 5141 ● Hong Kong 852 9688 9767  
 ● sales@ITG-Electronics.com ● www.ITG-Electronics.com Revision L.2 : September 14, 2021

\*Due to continuous product improvement, all specifications are subject to change without prior notice. Kindly contact an ITG field application engineer or a sales representative prior to purchase.



## Soldering Reflow Chart

Stage	Precaution	Recommended temperature profile
Reflow soldering	<p>Temperature profile can be referenced after confirming of adhesion , temperature of resistance to soldering heat , component size , soldering etc. sufficient .</p> <p><b>Note:</b>            please refer to the latest IPC/JEDEC J-STD-020: "Moisture/Reflow Sensitivity Classification for Nonhermetic Solid State Surface Mount Devices"</p>	<p>Temperature °C</p> <p>260 250 220 125 25</p> <p>10S (MAX)</p> <p>Natural cooling</p> <p>60s to 90s</p> <p>150s to 210s</p> <p>240s to 480s</p>







## Looking for pricing, stock, or lifecycle information?

Click below to explore more details on WIN SOURCE:

 [View SL3732A-R12KHF on WIN SOURCE](#)

 [ITG Electronics, Inc. Information](#)

## Optimize Your Supply Chain with WIN SOURCE Solutions

-  Global Sourcing Solution
-  Obsolete Management
-  Cost Control Management
-  Shortage Management
-  Alternative Solution
-  Excess Inventory Management