



**THE DATASHEET OF
ISL85005AFRZ-T7A**



ISL85005, ISL85005A

4.5V to 18V Input, 5A High Efficiency Synchronous Buck Regulator

FN8871
Rev.2.00
May 17, 2018

The [ISL85005](#) and [ISL85005A](#) are monolithic, synchronous buck regulators with integrated 5A, 18V high-side and low-side FETs. These devices provide an integrated bootstrap diode for the high-side gate driver to reduce the external parts count. These devices also have a wide input voltage range to support applications with input voltage from multi-cell batteries or regulated 5V and 12V power rails.

The ISL85005 and ISL85005A regulate the output voltage with current mode control and have an internal oscillator. The switching frequency of the ISL85005 is internally set as 500kHz, and can be synchronized to an external clock signal with frequency ranges from 300kHz to 2MHz. The ISL85005A has a fixed 500kHz switching frequency.

The ISL85005 has a fixed 2.3ms soft-start, while the ISL85005A features programmable soft-start to limit inrush current during startup. With the SS pin floating, the soft-start time of ISL85005A is also 2.3ms.

The ISL85005 can be configured in either forced Continuous Conduction Mode (CCM) or Diode Emulation Mode (DEM). DEM enables high efficiency at light-load conditions. The ISL85005A always operates in forced CCM.

The ISL85005 and ISL85005A have built-in protections including input UVLO protection, input and output overvoltage protection, high-side cycle-by-cycle current limit, low-side forward current limit and reverse current limit, and thermal shutdown.

Related Literature

For a full list of related documents, visit our website

- [ISL85005, ISL85005A](#) product pages

Features

- 4.5V to 18V input voltage range
- Internal 5A, 18V high-side and low-side MOSFET switches
- $\pm 1\%$, 0.8V feedback voltage reference
- Integrated bootstrap diode with undervoltage detection
- Current mode control with internal slope compensation
- Internal or external compensation options
- Default internally set 500kHz switching frequency
- Synchronization capability to external clock (ISL85005)
- Diode Emulation Mode (DEM) and Forced CCM (FCCM) options (ISL85005)
- Adjustable soft-start time (ISL85005A)
- Output Power-Good (PG) indicator
- Input Undervoltage Lockout (UVLO), input and output overvoltage protection
- High-side cycle-by-cycle current limit, low-side forward and reverse overcurrent protection, and thermal shutdown
- Small 12-pin 3mmx4mm Dual Flat No-Lead (DFN) package with EPAD for enhanced thermal performance

Applications

- Network and communications equipment
- Battery powered systems
- Multifunction printers
- Point-of-load regulators
- Standard 12V rail supplies
- Embedded computing systems

Typical Application

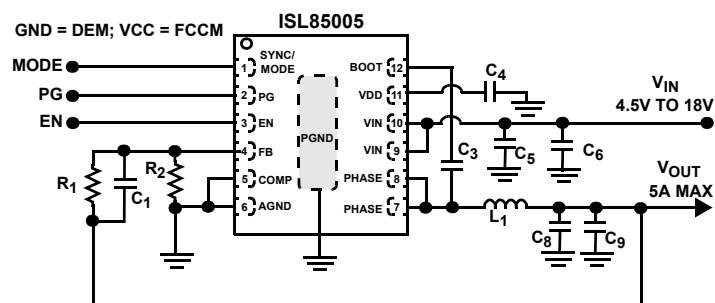

FIGURE 1. ISL85005 WITH INTERNAL COMPENSATION

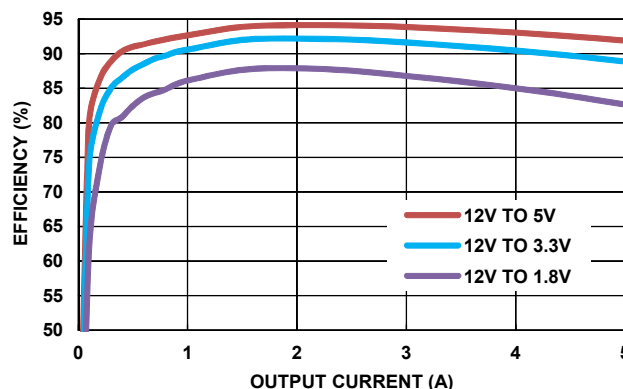

FIGURE 2. EFFICIENCY vs OUTPUT CURRENT

Table of Contents

Typical Application	1
Functional Block Diagram	3
Pin Configurations	4
Pin Descriptions	4
Ordering Information	5
Typical Application Schematics	6
Absolute Maximum Ratings	7
Thermal Information	7
Recommended Operating Conditions	7
Electrical Specifications	7
Typical Characteristics	9
Typical Performance Curves	11
Detailed Description	15
Operation Initialization	15
FCCM Control Scheme	15
Light-Load Operation.....	15
Synchronization Control	15
Enable, Soft-Start, and Disable	16
Output Voltage Selection	16
Protection Features	16
Forward Overcurrent Protection.....	16
Reverse Overcurrent Protection.....	16
Output Overvoltage Protection.....	16
Input Overvoltage Protection	16
Thermal Overload Protection	16
Power Derating Characteristics	16
Application Guidelines	17
Boot Undervoltage Detection	17
Switching Regulator Output Capacitor Selection.....	17
Output Inductor Selection.....	18
Input Capacitor Selection	18
Loop Compensation Design	19
Compensator Design Goal	19
High DC Gain	19
Layout Considerations.....	19
Revision History	21
Package Outline Drawing	22

Functional Block Diagram

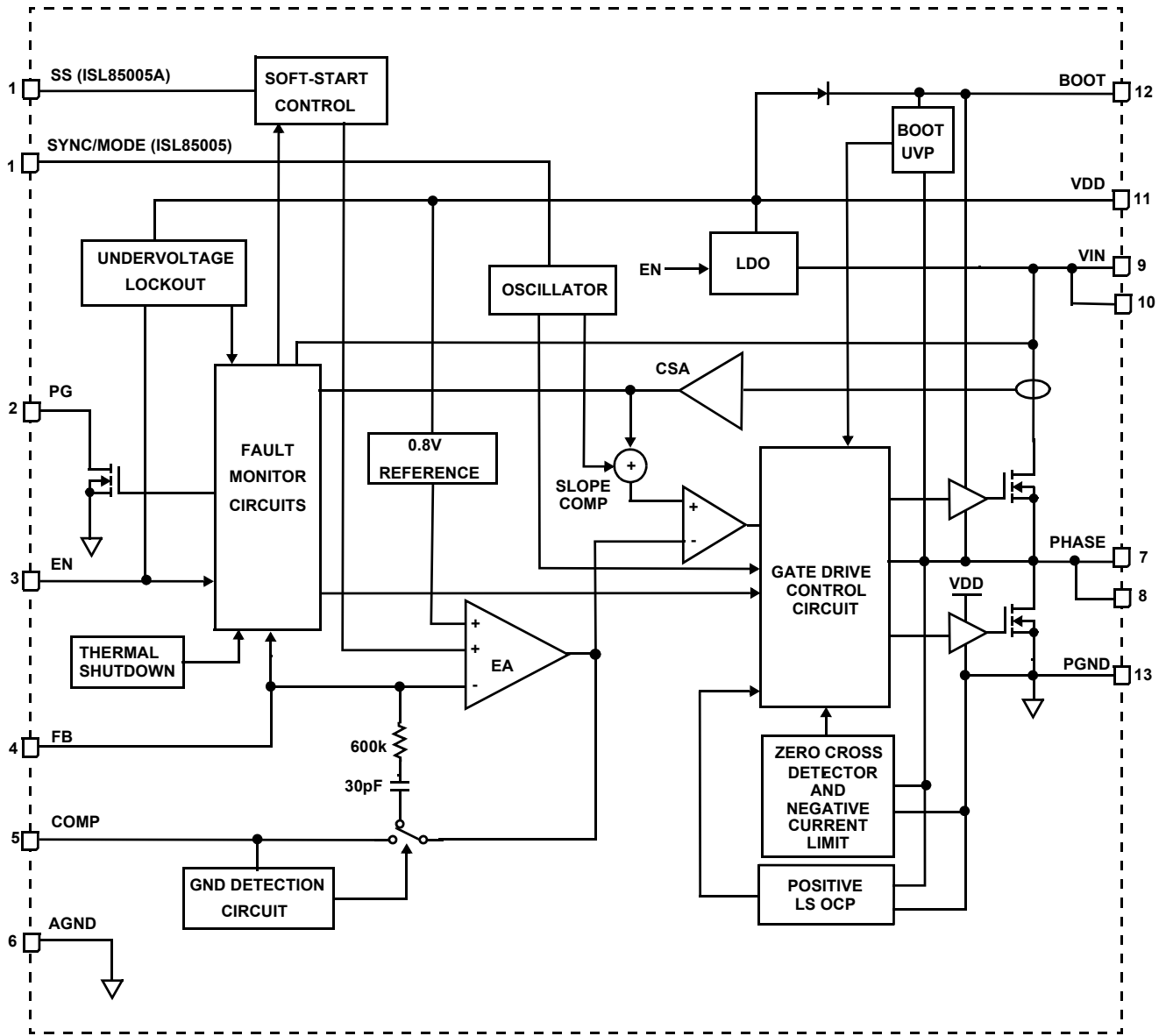
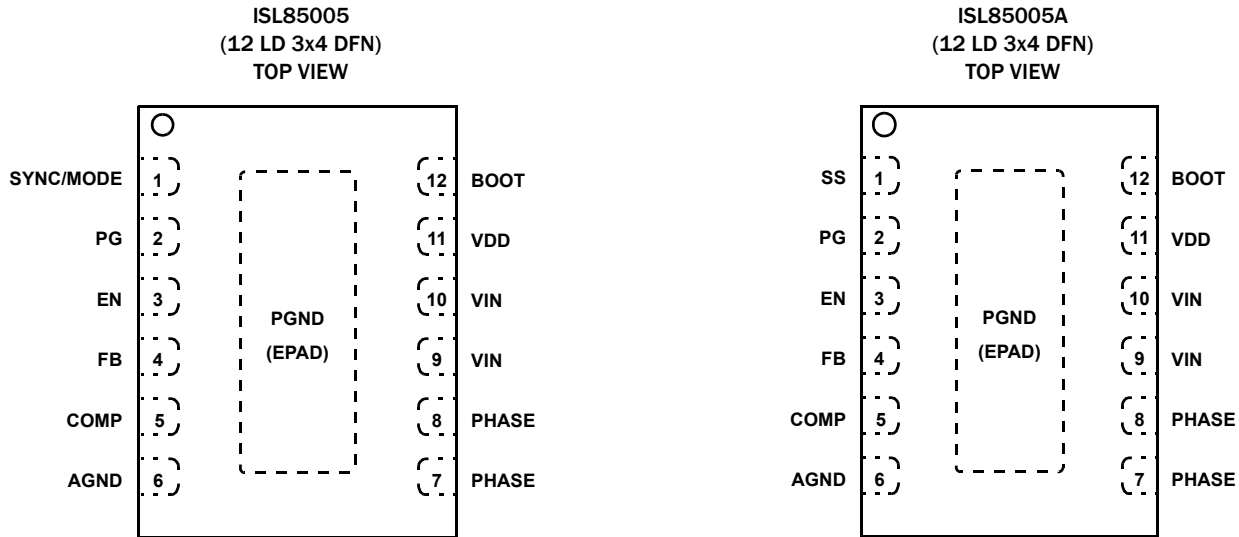

FIGURE 3. BLOCK DIAGRAM

Pin Configurations



Pin Descriptions

PIN NUMBER	PIN NAME	DESCRIPTION
1 (ISL85005)	SYNC/ MODE	Synchronization and mode selection input. Connect to VDD for Forced Continuous Conduction Mode (FCCM). Connect to AGND for Diode Emulation Mode (DEM). Connect to an external function generator for synchronization with the positive edge trigger. The internal 1MΩ pull-up resistor to VDD prevents an undefined logic state when SYNC is floating.
1 (ISL85005A)	SS	Soft-start input. This pin provides a programmable soft-start. When the chip is enabled, the regulated 3.5μA pull-up current source charges a capacitor connected from SS to ground. The output voltage of the converter follows the ramping voltage on this pin. Without the external capacitor, the default soft-start is 2.3ms.
2	PG	Power-good, open-drain output. Connect a 10kΩ to 100kΩ pull-up resistor between PG and VDD or between PG and a voltage not exceeding 5.5V. PG transitions high about 1.5ms after the switching regulator's output voltage reaches the regulation threshold, which is typically 85% of the regulated output voltage.
3	EN	Enable input. The regulator is held off when the pin is pulled to ground. The device is enabled when the voltage on this pin rises above 0.6V.
4	FB	Feedback input. The synchronous buck regulator employs a current mode control loop. FB is the negative input to the voltage loop error amplifier. The output voltage is set by an external resistor divider connected to FB. The output voltage can be set to any voltage between the power rail (reduced by converter losses) and the 0.8V reference.
5	COMP	Compensation node. This pin is connected to the output of the error amplifier and compensates the loop. Internal compensation meets most applications. Connect COMP to AGND to select internal compensation. Connect a compensation network between COMP and FB to use external compensation.
6	AGND	The AGND terminal. Provides the return path for the core analog control circuitry within the device. Connect AGND to the board ground plane. AGND and PGND are connected internally within the device. Do not operate the device with AGND and PGND connected to dissimilar voltages.
7, 8	PHASE	Phase switch output node. Connect to the external output inductor.
9, 10	VIN	Voltage supply input. The main power input for the IC. Connect to a suitable voltage supply. Place a ceramic capacitor from VIN to PGND, close to the IC for decoupling.
11	VDD	Low dropout linear regulator decoupling pin. VDD is the internally generated 5V supply voltage and is derived from VIN. The VDD powers all the internal core analog control blocks and drivers. Connect a 1μF capacitor from VDD to the board ground plane. If VIN is between 3V to 5.5V, then connect VDD directly to VIN to improve efficiency.
12	BOOT	Bootstrap input. A floating bootstrap supply pin for the upper power MOSFET gate driver. Connect a 0.1μF capacitor between BOOT and PHASE.
(EPAD)	PGND	Power ground terminal. Provides thermal relief for the package and is connected to the source of the low-side output MOSFET. Connect PGND to the board ground plane using as many vias as possible. AGND and PGND are connected internally within the device. Do not operate the device with AGND and PGND connected to dissimilar voltages.

Ordering Information

PART NUMBER (Notes 2, 3, 4)	PART MARKING	TEMP. RANGE (°C)	OPTION	FREQUENCY (kHz)	TAPE AND REEL (UNITS) (Note 1)	PACKAGE (RoHS COMPLIANT)	PKG. DWG. #
ISL85005FRZ	005F	-40 to +125	SYNC	500	-	12 Ld DFN	L12.3x4
ISL85005FRZ-T	005F	-40 to +125	SYNC	500	6k	12 Ld DFN	L12.3x4
ISL85005FRZ-TK	005F	-40 to +125	SYNC	500	1k	12 Ld DFN	L12.3x4
ISL85005FRZ-T7A	005F	-40 to +125	SYNC	500	250	12 Ld DFN	L12.3x4
ISL85005AFRZ	005A	-40 to +125	SOFT-START	500	-	12 Ld DFN	L12.3x4
ISL85005AFRZ-T	005A	-40 to +125	SOFT-START	500	6k	12 Ld DFN	L12.3x4
ISL85005AFRZ-TK	005A	-40 to +125	SOFT-START	500	1k	12 Ld DFN	L12.3x4
ISL85005AFRZ-T7A	005A	-40 to +125	SOFT-START	500	250	12 Ld DFN	L12.3x4
ISL85005AEVAL1Z	Evaluation Board						
ISL85005ADEMO1Z	Demonstration Board						
ISL85005EVAL1Z	Evaluation Board						
ISL85005DEMO1Z	Demonstration Board						

NOTES:

1. Refer to [TB347](#) for details about reel specifications.
2. These Pb-free plastic packaged products employ special Pb-free material sets, molding compounds/die attach materials, and 100% matte tin plate plus anneal (e3 termination finish, which is RoHS compliant and compatible with both SnPb and Pb-free soldering operations). Pb-free products are MSL classified at Pb-free peak reflow temperatures that meet or exceed the Pb-free requirements of IPC/JEDEC J STD-020.
3. For Moisture Sensitivity Level (MSL), see the [ISL85005](#), [ISL85005A](#) product information pages. For more information about MSL, refer to [TB363](#).
4. The ISL85005 is provided with a frequency synchronization input. The ISL85005A is a version of the part with programmable soft-start.

TABLE 1. KEY DIFFERENCES BETWEEN FAMILY OF PARTS

PART NUMBER	INTERNAL/EXTERNAL COMPENSATION	EXTERNAL FREQUENCY SYNC	PROGRAMMABLE SOFT-START	SWITCHING FREQUENCY (kHz)	CURRENT RATING
ISL85005A	Yes	No	Yes	500	5A
ISL85005	Yes	Yes	No	500	5A
ISL85003	Yes	Yes	No	500	3A
ISL85003A	Yes	No	Yes	500	3A

Typical Application Schematics

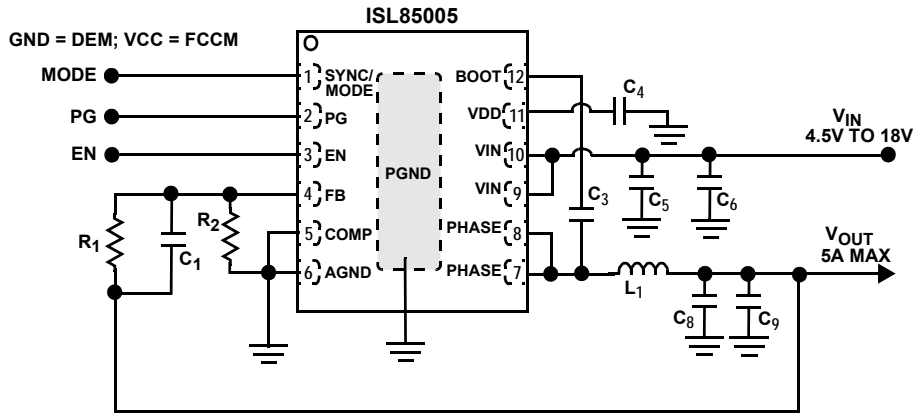

FIGURE 4. ISL85005 V_{IN} RANGE FROM 4.5V TO 18V WITH INTERNAL COMPENSATION

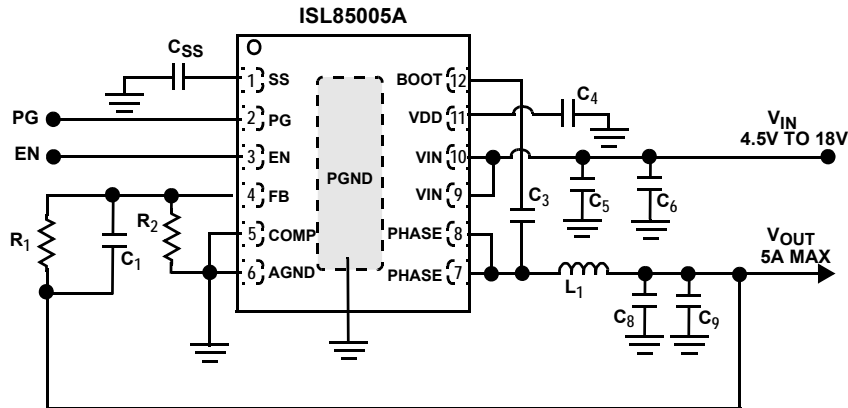

FIGURE 5. ISL85005A V_{IN} RANGE FROM 4.5V TO 18V, WITH INTERNAL COMPENSATION WITH PROGRAMMABLE SOFT-START

TABLE 2. COMPONENTS SELECTION (REFER TO [Figures 1 AND 2](#))

V_{OUT}	1.2V	1.8V	2.5V	3.3V	5V
C_5, C_6	10 μ F	10 μ F	10 μ F	10 μ F	10 μ F
C_8, C_9	47 μ F	47 μ F	47 μ F	47 μ F	47 μ F
C_1	12pF	12pF	12pF	12pF	12pF
L_1	3.3 μ H	3.3 μ H	3.3 μ H	3.3 μ H	3.3 μ H
R_1	499k Ω	499k Ω	499k Ω	499k Ω	499k Ω
R_2	998k Ω	392k Ω	232k Ω	157k Ω	95.3k Ω

NOTE: $V_{IN} = 12V$, $I_{OUT} = 5A$; The components selection table is a suggestion for typical application using internal compensation mode. For application that requires high output capacitance greater than 200 μ F, R_1 should be adjusted to maintain loop response bandwidth about 40kHz. See "[Loop Compensation Design](#)" on [page 19](#) for more detail.

Absolute Maximum Ratings

VIN, EN to AGND and PGND	-0.3V to +24V
PHASE to AGND and PGND	-0.7V to +24V (DC)
PHASE to AGND and PGND	-2V to +24V (40ns)
FB to AGND and PGND	-0.3V to +7V
BOOT to PHASE	-0.3V to +7V
VDD, COMP, SYNC, PG to AGND and PGND	-0.3V to +7V
Junction Temperature Range at 0A	-55°C to +150°C
ESD Rating	
Human Body Model (Tested per JESD22-A114F)	2.5kV
Machine Model (Tested per JESD22-A115-C)	150V
Charged Device Model (Tested per JESD22-C101-E)	1kV
Latch-Up (Tested per JESD-78D; Class 2, Level A)	100mA

CAUTION: Do not operate at or near the maximum ratings listed for extended periods of time. Exposure to such conditions may adversely impact product reliability and result in failures not covered by warranty.

NOTES:

- θ_{JA} is measured in free air with the component mounted on a high-effective thermal conductivity test board with “direct attach” features. See [TB379](#).
- For θ_{JC} , the “case temp” location is the center of the exposed metal pad on the package underside.

Thermal Information

Thermal Resistance	θ_{JA} (°C/W)	θ_{JC} (°C/W)
DFN Package (Notes 5, 6)	41	3
Maximum Storage Temperature Range	-65°C to +150°C	
Junction Temperature Range	-40°C to +125°C	
Pb-Free Reflow Profile	see TB493	

Recommended Operating Conditions

VIN Supply Voltage Range	4.5V to 18V
Load Current Range	0A to 5A

Electrical Specifications All parameter limits are established over the recommended operating conditions with $T_J = -40^\circ\text{C}$ to $+125^\circ\text{C}$, and with $V_{IN} = 12\text{V}$ unless otherwise noted. Typical values are at $T_A = +25^\circ\text{C}$. **Boldface limits apply across the operating junction temperature range, -40°C to $+125^\circ\text{C}$.**

PARAMETER	SYMBOL	TEST CONDITIONS	MIN (Note 7)	TYP	MAX (Note 7)	UNIT
SUPPLY VOLTAGE						
VIN Voltage Range	VIN		4.5		18	V
VIN Quiescent Supply Current	IQ	SYNC = Low, EN > 1V, FB = 0.85V, not switching		3.2	4.5	mA
VIN Shutdown Supply Current	ISD	EN = AGND		6	11	μA
UNDERVOLTAGE LOCKOUT						
VIN UVLO Threshold		Rising edge		4.20	4.35	V
		Falling edge	3.5	3.8		V
INTERNAL VDD LDO						
VDD Output Voltage		VIN = 6V to 18V, I _{VDD} = 0mA to 30mA	4.30	5.00	5.50	V
VDD Output Current Limit				50		mA
OSCILLATOR						
Nominal Switching Frequency	f _{SW}		400	500	600	kHz
Minimum On-Time	t _{ON}	I _{OUT} = 0mA (Note 8)		120	140	ns
Minimum Off-Time	t _{OFF}	(Note 8)		140	180	ns
Synchronization Range	SYNC	ISL85005	300		2000	kHz
SYNC High-Time	t _{HI}	ISL85005	100			ns
SYNC Low-Time	t _{LO}	ISL85005	100			ns
SYNC Logic Input Low		ISL85005			0.50	V
SYNC Logic Input High		ISL85005	1.20			V
ERROR AMPLIFIER						
FB Regulation Voltage	V _{FB}	VIN = 4.5V to 18V	0.792	0.800	0.808	V
FB Leakage Current		V _{FB} = 0.8V (Note 8)		0.3	10.0	nA
Open-Loop Bandwidth	BW			5.5		MHz
Gain				70		dB

Electrical Specifications All parameter limits are established over the recommended operating conditions with $T_J = -40^\circ\text{C}$ to $+125^\circ\text{C}$, and with $V_{IN} = 12\text{V}$ unless otherwise noted. Typical values are at $T_A = +25^\circ\text{C}$. **Boldface limits apply across the operating junction temperature range, -40°C to $+125^\circ\text{C}$.** (Continued)

PARAMETER	SYMBOL	TEST CONDITIONS	MIN (Note 7)	TYP	MAX (Note 7)	UNIT
Output Drive		$V_{COMP} = 1.5\text{V}$		± 110		μA
Current Sense Gain	RT			0.15		Ω
Slope Compensation	Se	$f_{SW} = 500\text{kHz}$		550		$\text{mV}/\mu\text{s}$
ENABLE INPUT						
EN Input Threshold		Rising edge	0.5	0.6	0.7	V
		Hysteresis	60	100	140	mV
SOFT-START FUNCTION						
Default Soft-Start Time		ISL85005, ISL85005A with SS pin floating	1.0	2.3	3.6	ms
SS Internal Soft-Start Charging Current		ISL85005A	2.5	3.5	4.5	μA
POWER-GOOD OPEN-DRAIN OUTPUT						
Output Low Voltage		$I_{PG} = 5\text{mA}$ sinking		0.25		V
PG Pin Leakage Current		$V_{PG} = V_{DD}$		0.01		μA
PG Lower Threshold		Percentage of output regulation	80	85	90	%
PG Upper Threshold		Percentage of output regulation	110	115	120	%
PG Thresholds Hysteresis				3		%
Delay Time		Rising edge		1.5		ms
		Falling edge		18		μs
FAULT PROTECTION						
High-Side MOSFET Forward Current Limit Threshold	I_{POCP}		6	7.8	9.5	A
Low-Side MOSFET Reverse Current Limit Threshold	I_{NOCP}	Current forced into PHASE node, high-side MOSFET is off, SYNC = High		-3.3		A
Low-Side MOSFET Forward Current Limit Threshold		Current in low-side MOSFET at end of low-side cycle.		8.6		A
V_{IN} Overvoltage Threshold		V_{IN} rising	19	20		V
		Hysteresis		1		V
Thermal Shutdown Threshold	T_{SD}	Temperature rising		165		$^\circ\text{C}$
	T_{HYS}	Hysteresis		10		$^\circ\text{C}$
POWER MOSFET						
High-Side MOSFET On-Resistance	R_{HDS}	$I_{PHASE} = 100\text{mA}$		57	95	$\text{m}\Omega$
Low-Side MOSFET On-Resistance	R_{LDS}	$I_{PHASE} = 100\text{mA}$		40	75	$\text{m}\Omega$
PHASE Pull-Down Resistor		EN = AGND		10		$\text{k}\Omega$
DIODE EMULATION						
Zero-Cross Detection Threshold		ISL85005		150		mA

NOTE:

- Compliance to datasheet limits is assured by one or more methods: production test, characterization, and/or design.
- Compliance to limits is assured by characterization and design.

Typical Characteristics $V_{IN} = 12V, T_A = +25^\circ C$, unless otherwise noted.

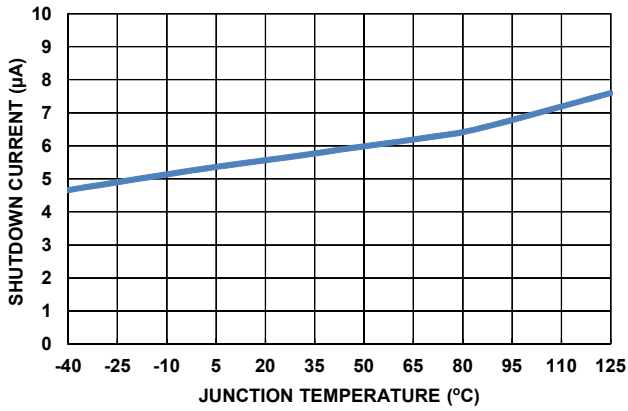

FIGURE 6. V_{IN} SHUTDOWN CURRENT vs JUNCTION TEMPERATURE

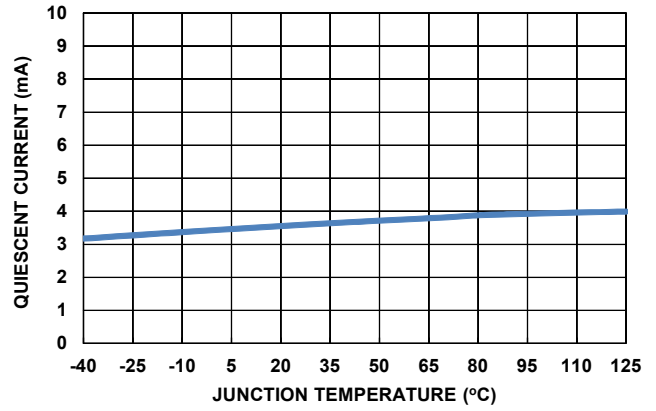

FIGURE 7. V_{IN} QUIESCENT CURRENT vs JUNCTION TEMPERATURE

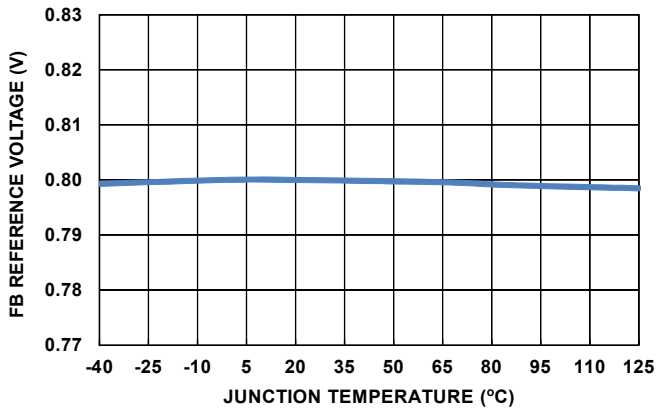

FIGURE 8. FEEDBACK VOLTAGE vs JUNCTION TEMPERATURE

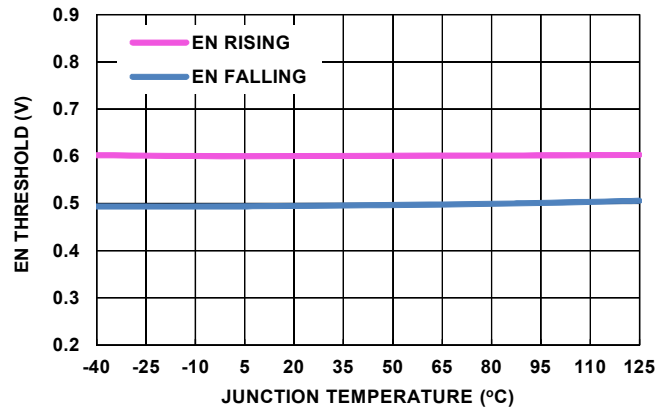

FIGURE 9. ENABLE THRESHOLDS vs JUNCTION TEMPERATURE

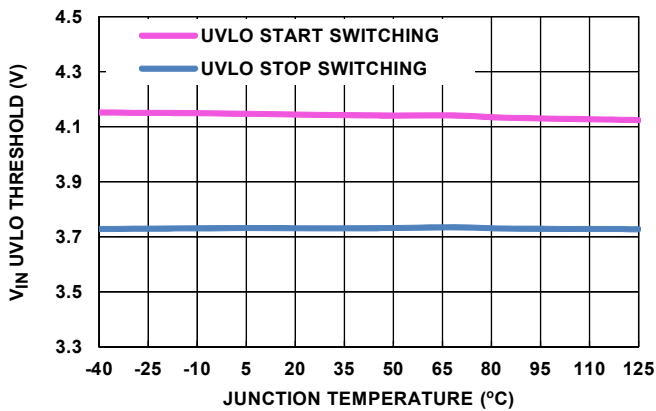

FIGURE 10. V_{IN} UVLO THRESHOLD vs JUNCTION TEMPERATURE

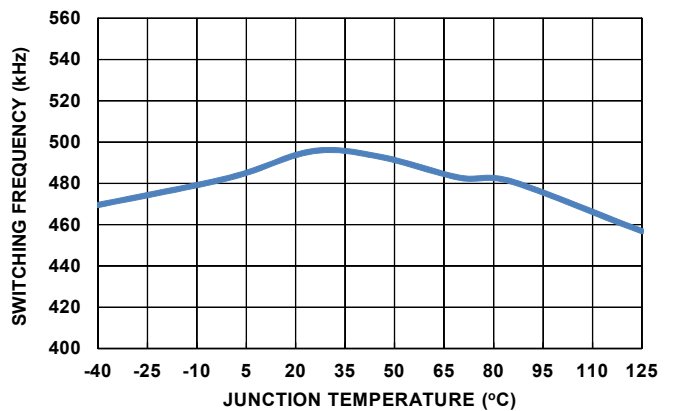

FIGURE 11. SWITCHING FREQUENCY vs JUNCTION TEMPERATURE

Typical Characteristics $V_{IN} = 12V, T_A = +25^\circ C$, unless otherwise noted. (Continued)

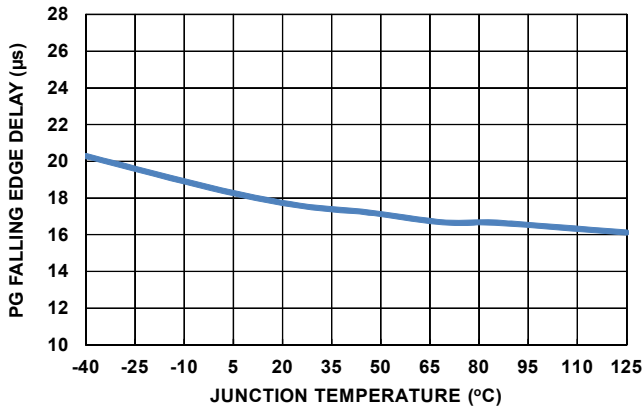

FIGURE 12. PG DELAY (FALLING) vs JUNCTION TEMPERATURE

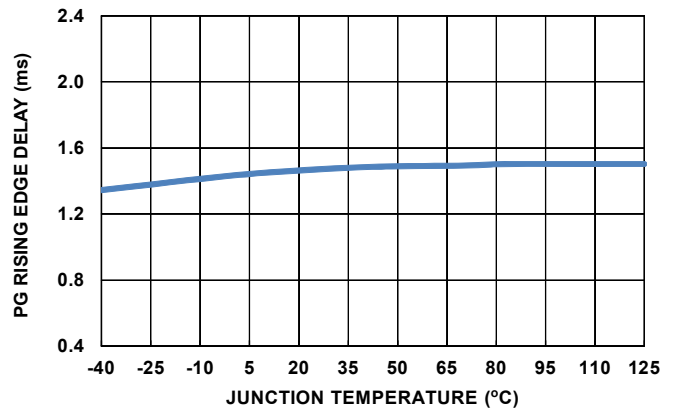

FIGURE 13. PG DELAY (RISING) vs JUNCTION TEMPERATURE

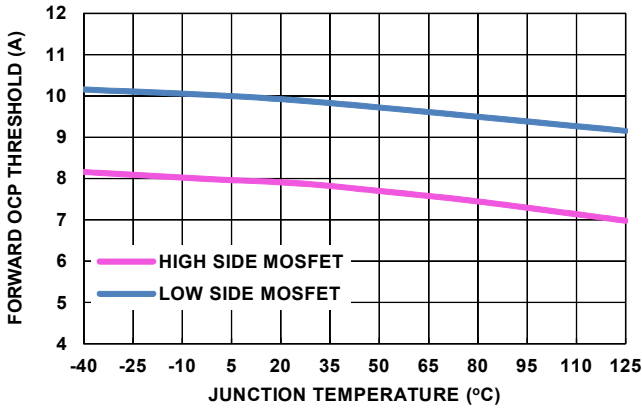

FIGURE 14. FORWARD OCP THRESHOLD vs JUNCTION TEMPERATURE

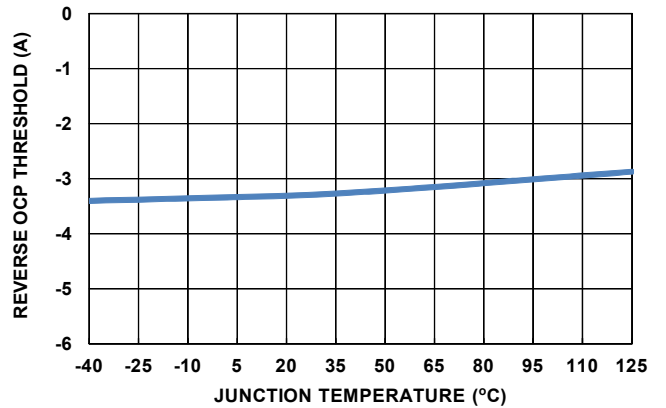

FIGURE 15. LOW-SIDE REVERSE OCP THRESHOLD vs JUNCTION TEMPERATURE

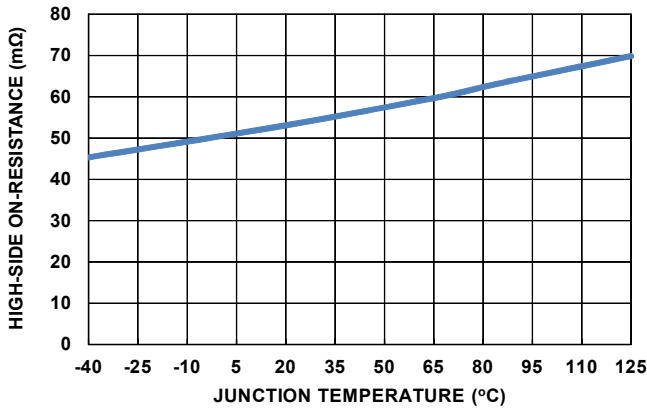

FIGURE 16. HIGH-SIDE $r_{DS(ON)}$ vs JUNCTION TEMPERATURE

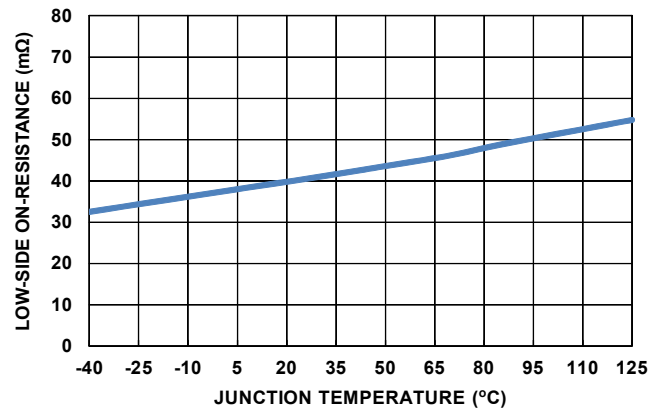

FIGURE 17. LOW-SIDE $r_{DS(ON)}$ vs JUNCTION TEMPERATURE

Typical Performance Curves

Circuit of [Figure 1](#). $V_{IN} = 12V$, $V_{OUT} = 5V$, $L = 3.3\mu H$, $f_{SW} = 500kHz$, $T_A = +25^\circ C$, unless otherwise noted.

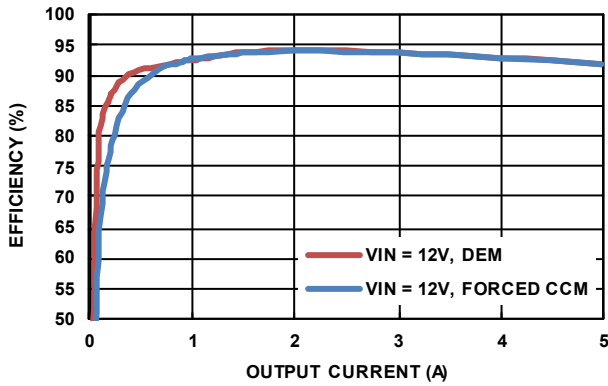

FIGURE 18. EFFICIENCY vs LOAD, $V_{OUT} = 5V$

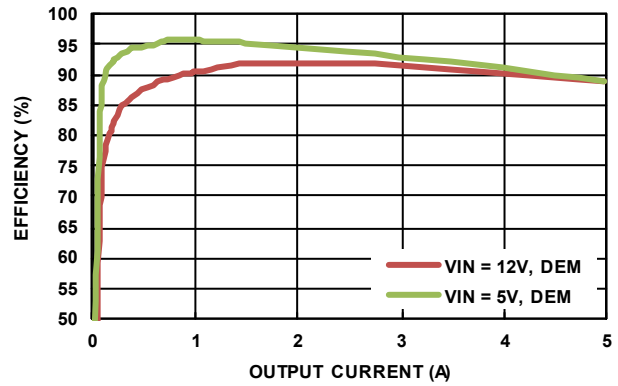

FIGURE 19. EFFICIENCY vs LOAD, $V_{OUT} = 3.3V$, DEM

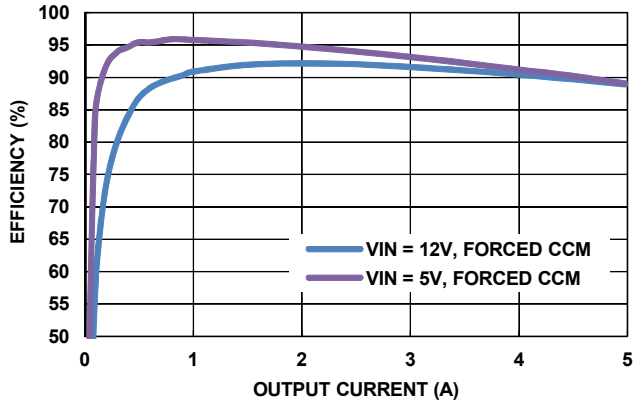

FIGURE 20. EFFICIENCY vs LOAD, $V_{OUT} = 3.3V$, FORCED CCM

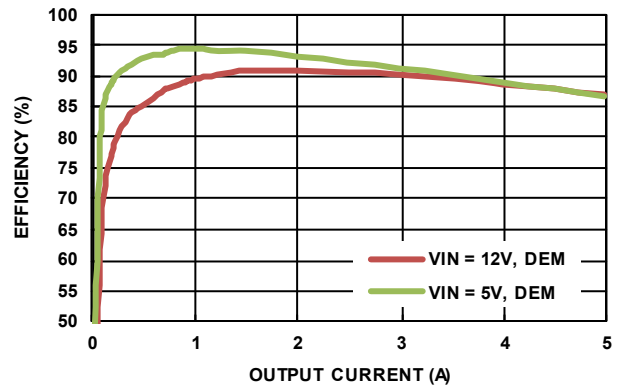

FIGURE 21. EFFICIENCY vs LOAD, $V_{OUT} = 2.5V$, DEM

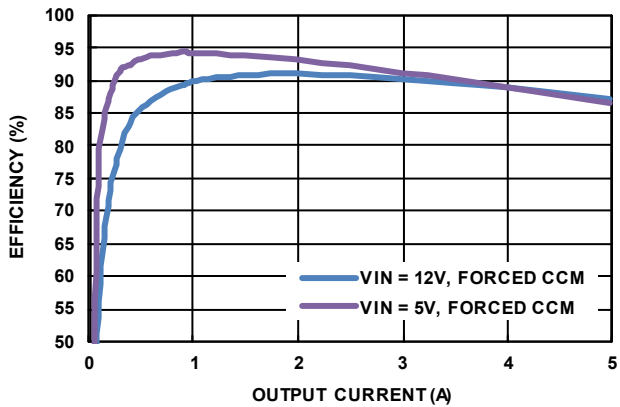

FIGURE 22. EFFICIENCY vs LOAD, $V_{OUT} = 2.5V$, FORCED CCM

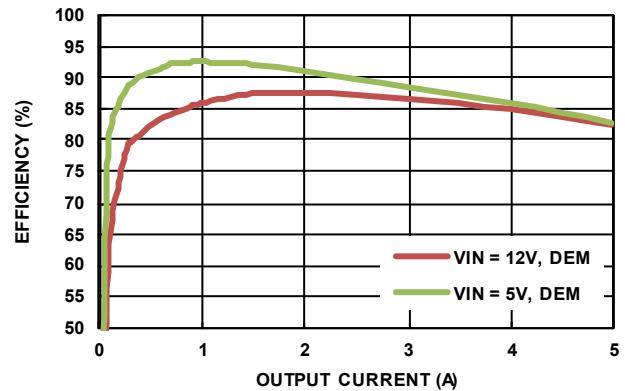

FIGURE 23. EFFICIENCY vs LOAD, $V_{OUT} = 1.8V$, DEM

Typical Performance Curves

Circuit of [Figure 1](#). $V_{IN} = 12V$, $V_{OUT} = 5V$, $L = 3.3\mu H$, $f_{SW} = 500kHz$, $T_A = +25^\circ C$, unless otherwise noted. (Continued)

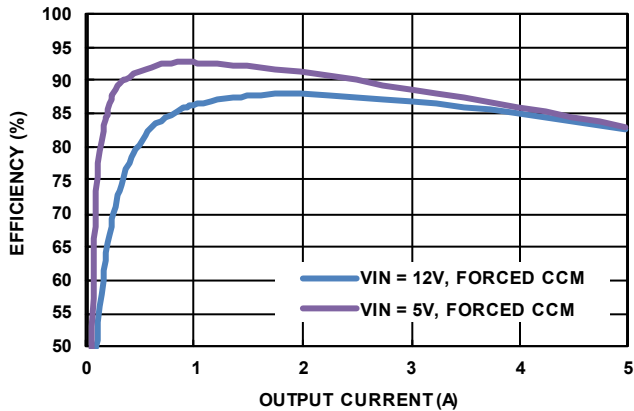

FIGURE 24. EFFICIENCY vs LOAD, $V_{OUT} = 1.8V$, FORCED CCM

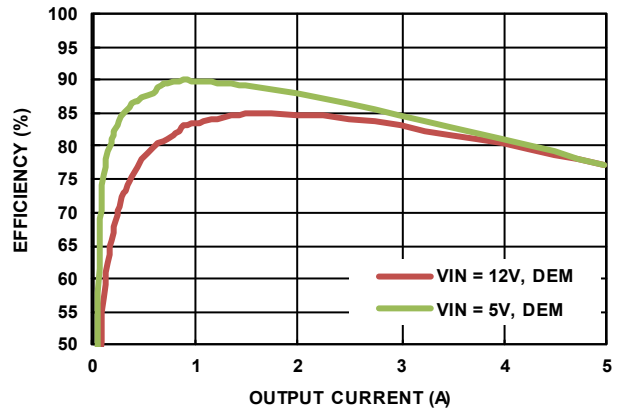

FIGURE 25. EFFICIENCY vs LOAD, $V_{OUT} = 1.2V$, DEM

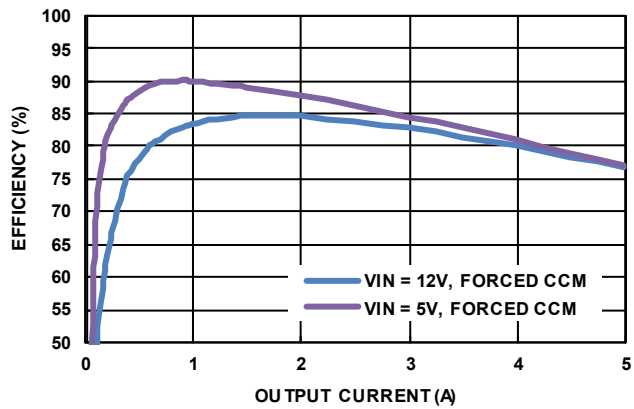

FIGURE 26. EFFICIENCY vs LOAD, $V_{OUT} = 1.2V$, FORCED CCM

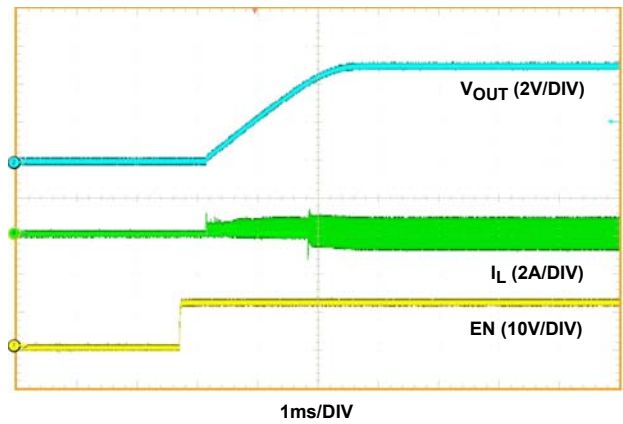

FIGURE 27. START-UP WITH EN, NO LOAD

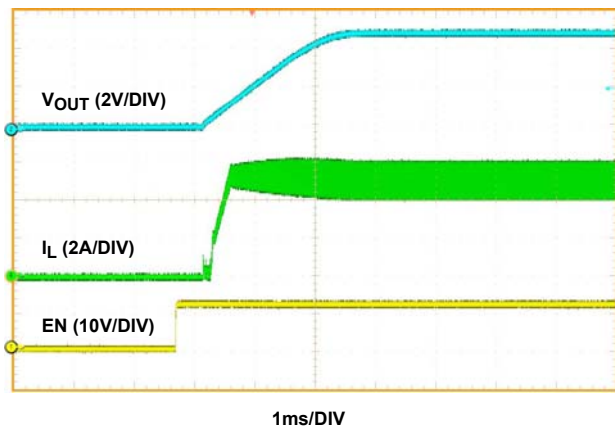

FIGURE 28. START-UP WITH EN, $I_{OUT} = 5A$

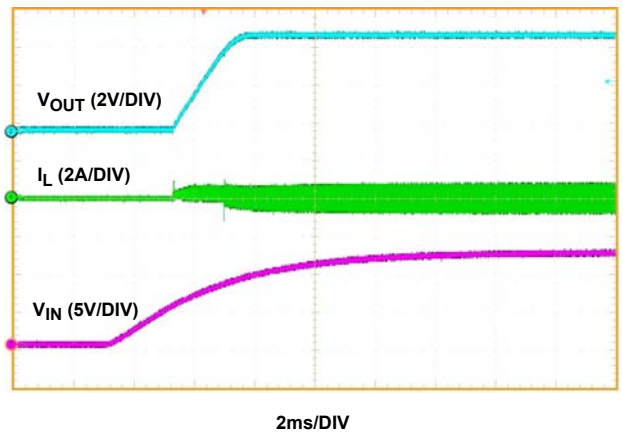

FIGURE 29. START-UP WITH V_{IN} , NO LOAD

Typical Performance Curves

Circuit of [Figure 1](#). $V_{IN} = 12V$, $V_{OUT} = 5V$, $L = 3.3\mu H$, $f_{SW} = 500kHz$, $T_A = +25^\circ C$, unless otherwise noted. (Continued)

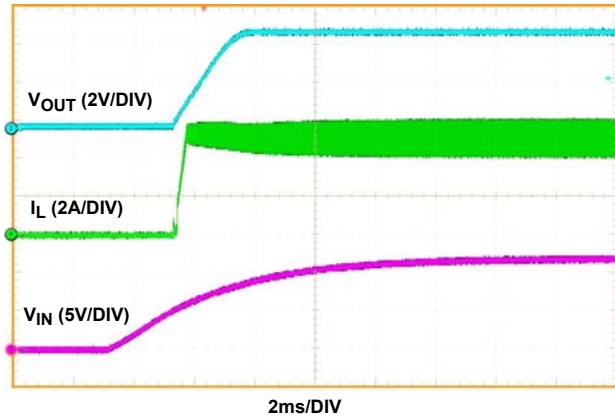

FIGURE 30. START-UP WITH V_{IN} , $I_{OUT} = 5A$

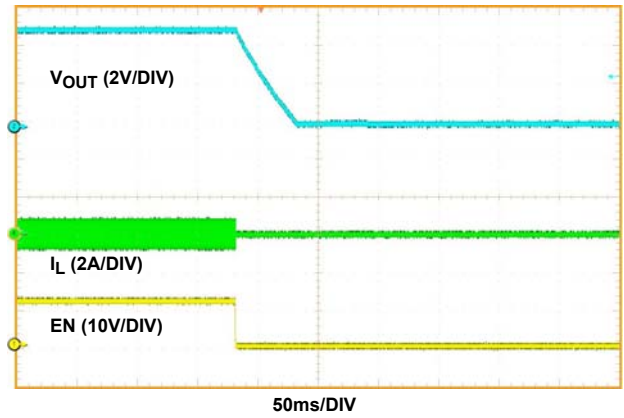

FIGURE 31. SHUTDOWN WITH EN, $I_{OUT} = 10mA$

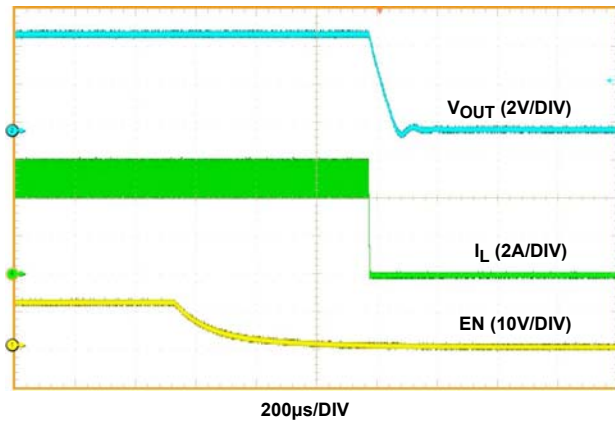

FIGURE 32. SHUTDOWN WITH EN, $I_{OUT} = 5A$

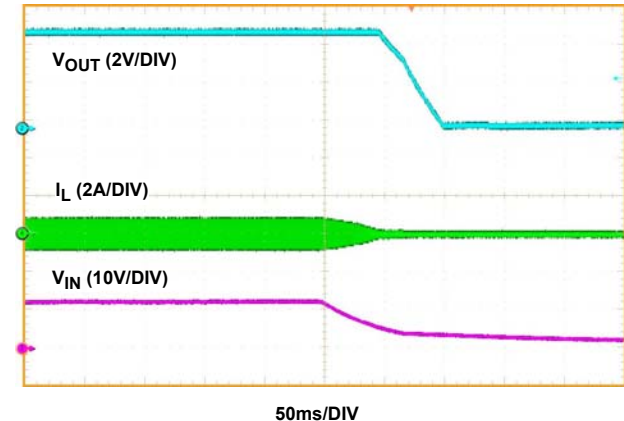

FIGURE 33. SHUTDOWN WITH V_{IN} , $I_{OUT} = 10mA$

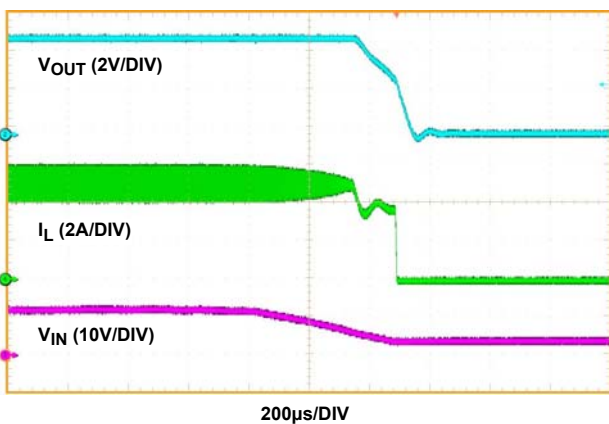

FIGURE 34. SHUTDOWN WITH V_{IN} , $I_{OUT} = 5A$

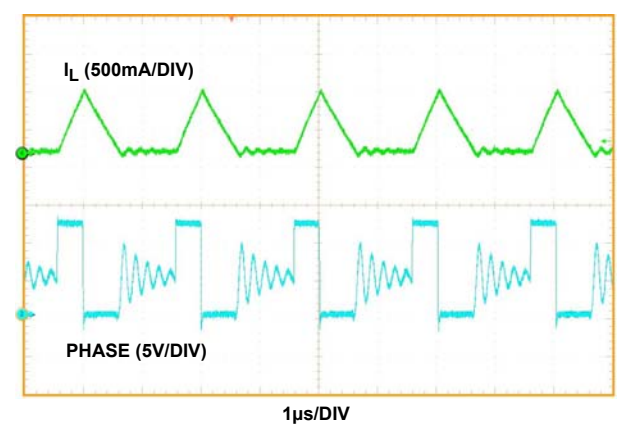

FIGURE 35. STEADY STATE OPERATION IN DCM, $I_{OUT} = 0.2A$

Typical Performance Curves

Circuit of [Figure 1](#). $V_{IN} = 12V$, $V_{OUT} = 5V$, $L = 3.3\mu H$, $f_{SW} = 500kHz$, $T_A = +25^\circ C$, unless otherwise noted. (Continued)

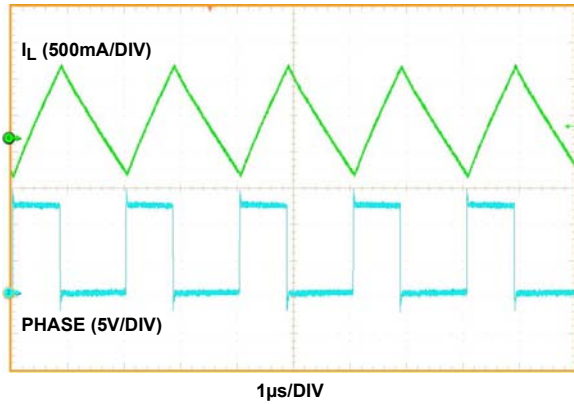

FIGURE 36. STEADY STATE IN FORCED CCM, $I_{OUT} = 0.2A$

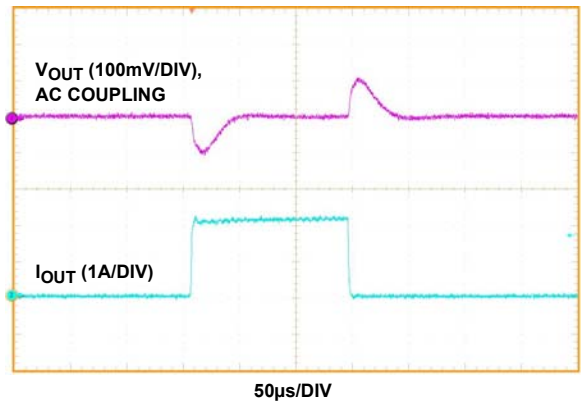

FIGURE 37. LOAD TRANSIENT, $0A \rightarrow 2.5A \rightarrow 0A$, $2.5A/\mu s$

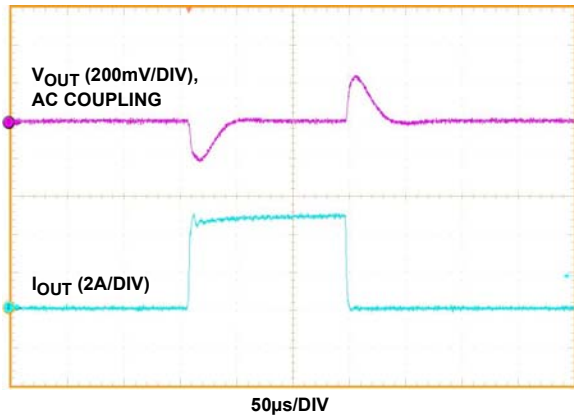

FIGURE 38. LOAD TRANSIENT, $0A \rightarrow 5A \rightarrow 0A$, $2.5A/\mu s$

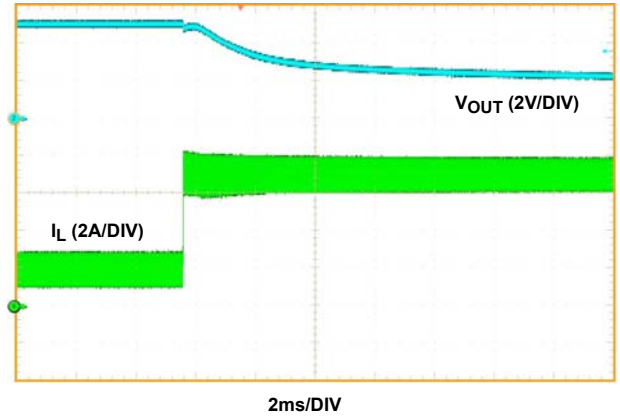

FIGURE 39. HIGH-SIDE FORWARD OVER CURRENT PROTECTION

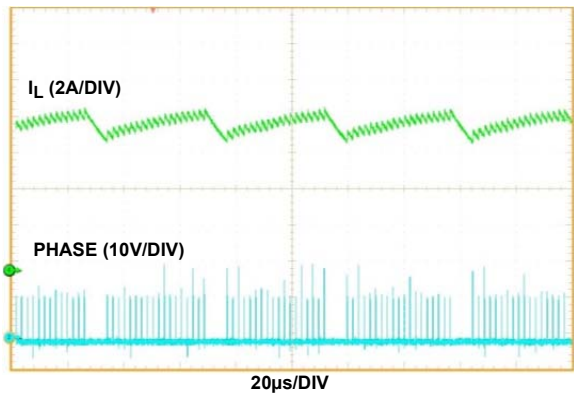

FIGURE 40. OUTPUT SHORT-CIRCUIT BEHAVIOR

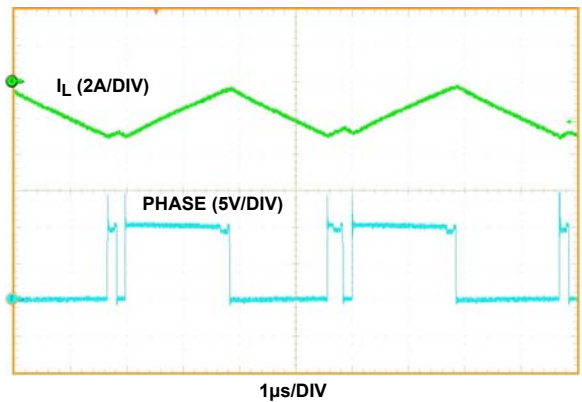

FIGURE 41. LOW-SIDE MOSFET REVERSE OVER CURRENT PROTECTION

Detailed Description

The ISL85005 and ISL85005A combine a synchronous buck controller with a pair of integrated switching MOSFETs. The buck controller drives the internal high-side and low-side N-channel MOSFETs to deliver load currents up to 5A. The buck regulator can operate from an unregulated DC source, such as a battery, with a voltage ranging from +4.5V to +18V. An internal 5V LDO voltage regulator is used to bias the controller. The converter output voltage is programmed using an external resistor divider and generates regulated voltages down to 0.8V. These features make the regulator suited for a wide range of applications.

The controller uses a current mode loop, which simplifies the loop compensation and permits fixed frequency operation over a wide range of input and output voltages. The internal feedback loop compensation option allows for a lower number of external components. The regulator switches at a default of 500kHz, or it can be synchronized from 300kHz to 2MHz on the ISL85005.

The buck regulator is equipped with a lossless current limit scheme. The current in the output stage is derived from temperature compensated measurements of the drain-to-source voltage of the internal power MOSFETs. The current limit threshold is internally set at 7.8A.

Operation Initialization

To start operation, pull EN above 0.6V (typical). The power-on reset circuitry prevents operation if the input voltage is below 4.2V. When the power-on reset requirement is met, the controller soft-starts with a 2.3ms ramp on the ISL85005 or at a rate determined by the value of a capacitor connected between SS and AGND on the ISL85005A.

FCCM Control Scheme

The regulator employs a current mode Pulse-Width Modulation (PWM) control scheme for fast transient response and pulse-by-pulse current limiting. The current loop consists of the oscillator, the PWM comparator, current-sensing circuit, and a slope compensation circuit. The gain of the current-sensing circuit is typically 150mV/A and the slope compensation is 1.1V/T. The reference for the current loop is in turn provided by the output of an Error Amplifier (EA), which compares the feedback signal at the FB pin to the integrated 0.8V reference. Therefore, the output voltage is regulated by using the error amplifier to control the reference for the current loop.

The error amplifier is an operational amplifier that converts the voltage error signal to a voltage output. The voltage loop is internally compensated with the 30pF and 600kΩ RC network that can support most applications.

PWM operation is initialized by the clock from the oscillator. The upper MOSFET is turned on at the beginning of a cycle and the current in the MOSFET starts to ramp up. When the sum of the current amplifier CSA signal and the slope compensation reaches the control reference of the current loop, the PWM comparator sends a signal to the logic to turn off the upper MOSFET and turn on the lower MOSFET. The lower MOSFET stays on until the end of the cycle. [Figure 42](#) shows the typical operating waveforms during Continuous Conduction Mode (CCM) operation. The dotted lines illustrate the sum of the compensation ramp and the current-sense amplifier's output.

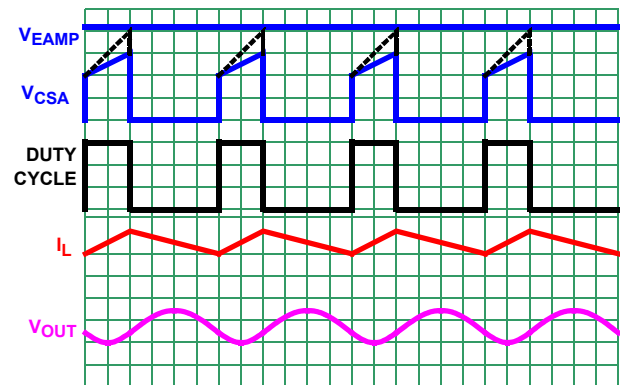

FIGURE 42. CCM OPERATION WAVEFORMS

Light-Load Operation

The ISL85005 monitors both the current in the low-side MOSFET and the voltage of the FB node for regulation. Pulling the SYNC/MODE pin low allows the ISL85005 to enter discontinuous operation when lightly loaded by operating the low-side MOSFET in Diode Emulation Mode (DEM). In this mode, reverse current is not allowed in the inductor, and the output falls naturally to the regulation voltage before the high-side MOSFET is switched for the next cycle. The boundary is set by [Equation 1](#):

$$I_{OUT} = \frac{V_{OUT}(1-D)}{2Lf_{SW}} \quad (\text{EQ. 1})$$

where D = duty cycle, f_{SW} = switching frequency, L = inductor value, I_{OUT} = output loading current, V_{OUT} = output voltage.

Synchronization Control

The ISL85005 can be synchronized from 300kHz to 2MHz by an external signal applied to the SYNC pin. The rising edge on the SYNC triggers the rising edge of the PHASE pulse. Make sure that the on-time of the SYNC pulse is greater than 100ns. Although the maximum synchronized frequency can be as high as 2MHz, the ISL85005 is a current mode regulator that requires a minimum of 140ns on-time to regulate properly. As an example, the maximum recommended synchronized frequency will be about 600kHz with 12V_{IN} and 1V_{OUT}.

Enable, Soft-Start, and Disable

Chip operation begins after V_{IN} exceeds its rising POR trip point (nominal 4.2V). If EN is held low externally, nothing happens until this pin is released. When the voltage on the EN pin is above 0.6V, the LDO powers up and soft-start control begins. The default soft-start time is 2.3ms.

On the ISL85005A, let SS float to select the internal soft-start time with a default of 2.3ms. The soft-start time is extended by connecting an external capacitor between SS and AGND. A $3.5\mu\text{A}$ current source charges up the capacitor. The soft-start capacitor is charged until the voltage on the SS pin reaches a 2.0V clamp level. However, the output voltage reaches its regulation value when the voltage on the SS pin reaches approximately 0.9V. The capacitor, along with an internal $3.5\mu\text{A}$ current source, sets the soft-start interval of the converter, t_{SS} , according to [Equation 2](#):

$$C_{SS}[\text{nF}] = 3.5 \cdot t_{SS}[\text{mS}] - 1.6\text{nF} \quad (\text{EQ. 2})$$

Output Voltage Selection

The regulator output voltage is programmed using an external resistor divider that scales the feedback relative to the internal reference voltage. The scaled voltage is fed back to the inverting input of the error amplifier (see [Figure 43](#)).

The output voltage programming resistor, R_2 , depends on the value chosen for the feedback resistor, R_1 , and the desired regulator output voltage, V_{OUT} (see [Equation 2](#)). The R_1 value determines the gain of the feedback loop. See “[Loop Compensation Design](#)” on [page 19](#) for more details. The value for the feedback resistor is typically between 10k Ω and 600k Ω .

$$R_2 = \frac{R_1 \cdot 0.8\text{V}}{V_{OUT} - 0.8\text{V}} \quad (\text{EQ. 3})$$

If the output voltage desired is 0.8V, then R_2 is left unpopulated. R_1 is still required to set the low frequency pole of the modulator compensation.

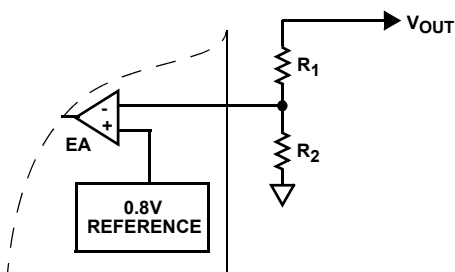

FIGURE 43. EXTERNAL RESISTOR DIVIDER

Protection Features

The regulator limits current in all on-chip power devices. Overcurrent limits are applied to the two output switching MOSFETs as well as to the LDO linear regulator that feeds VDD. Input and output overvoltage protection circuitry on the switching regulator provides a second layer of protection.

Forward Overcurrent Protection

The current flowing through the internal high-side MOSFET is monitored during the on-time and compared to a typical 7.8A overcurrent limit threshold. If the current exceeds the overcurrent limit threshold, the high-side MOSFET is immediately turned off and does not turn on again until the next switching cycle. The current through the low-side switching MOSFET is sampled during off time. If the low-side MOSFET current exceeds 8.6A at the end of the low-side cycle, then the high-side MOSFET skips the next cycle, allowing the inductor current to decay to a safe level before resuming switching.

Reverse Overcurrent Protection

Similar to the overcurrent, the negative current protection is enabled by monitoring the current across the low-side MOSFET, as shown in [Figure 41 on page 14](#). When the inductor current reaches -3.3A, the synchronous rectifier is turned off. This limits the ability of the regulator to actively pull down the output voltage and prevents large reverse currents that may fall outside the range of the high-side current-sense amplifier.

Output Overvoltage Protection

The output overvoltage protection is triggered when the output voltage exceeds 115% of the nominal voltage setting point. In this condition, high-side and low-side MOSFETs are turned off until the output drops to within the regulation band. When the output is in regulation, the controller restarts under internal SS control.

Input Overvoltage Protection

The input overvoltage protection system prevents operation of the switching regulator when the input voltage is higher than 20V. The high-side and low-side MOSFETs are turned off and the converter restarts under internal SS control when the input voltage returns to normal.

Thermal Overload Protection

Thermal overload protection limits the maximum die temperature, and thus the total power dissipation in the regulator. A sensor on the chip monitors the junction temperature. A signal is sent to the fault monitor circuits whenever the junction temperature (T_J) exceeds +165°C, and this causes the switching regulator and LDO to shut down.

The switching regulator turns on again and soft-starts after the IC's junction temperature cools by 10°C. For continuous operation, do not exceed the +125°C junction temperature rating.

Power Derating Characteristics

To prevent the regulator from exceeding the maximum junction temperature, some thermal analysis is required. The temperature rise is given by [Equation 4](#):

$$T_{RISE} = (PD)(\theta_{JA}) \quad (\text{EQ. 4})$$

where PD is the power dissipated by the regulator and θ_{JA} is the thermal resistance from the junction of the die to the ambient

temperature. The junction temperature, T_J , is given by [Equation 5](#):

$$T_J = (T_A + T_{RISE}) \quad (\text{EQ. 5})$$

where T_A is the ambient temperature. The DFN package's θ_{JA} is 49 ($^{\circ}\text{C}/\text{W}$).

The actual junction temperature should not exceed the absolute maximum junction temperature of +125 $^{\circ}\text{C}$ when considering the thermal design.

Application Guidelines

Boot Undervoltage Detection

The internal driver of the high-side FET is equipped with a boot Undervoltage (UV) detection circuit. If the voltage difference between BOOT and PHASE falls below 2.5V, the UV detection circuit allows the low-side MOSFET on for 300ns to recharge the bootstrap capacitor.

Although the ISL85005 and ISL85005A include an internal bootstrap diode, efficiency can be improved by using an external supply voltage and bootstrap Schottky diode. The external diode is then sourced from a fixed external 5V supply or from the output of the switching regulator if this is at 5V. The bootstrap diode can be a low cost type, such as the BAT54.

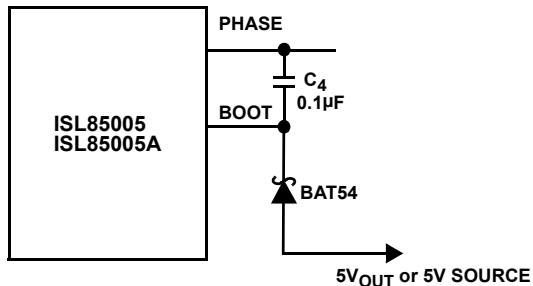

FIGURE 44. EXTERNAL BOOTSTRAP DIODE

Switching Regulator Output Capacitor Selection

An output capacitor is required to filter the inductor current and supply the load transient current. The filtering requirements are a function of the switching frequency, the ripple current, and the required output ripple. The load transient requirements are a function of the slew rate (di/dt) and the magnitude of the transient load current. These requirements are generally met with a mix of capacitor types and careful layout.

High-frequency ceramic capacitors initially supply the transient and slow the current load rate seen by the bulk capacitors. The bulk filter capacitor values are generally determined by the Equivalent Series Resistance (ESR) and voltage rating requirements rather than actual capacitance requirements.

Place the high-frequency decoupling capacitors as close to the power pins of the load as physically possible. Be careful not to add inductance in the circuit board wiring that could cancel the usefulness of these low inductance components. Consult with

the manufacturer of the load on specific decoupling requirements.

The shape of the output voltage waveform during a load transient that represents the worst case loading conditions ultimately determines the number of output capacitors and their type. When this load transient is applied to the converter, most of the energy required by the load is initially delivered from the output capacitors. This is due to the finite amount of time required for the inductor current to slew up to the level of the output current required by the load. This phenomenon results in a temporary dip in the output voltage. At the very edge of the transient, the Equivalent Series Inductance (ESL) of each capacitor induces a spike that adds on top of the existing voltage drop due to the ESR.

After the initial spike, attributable to the ESR and ESL of the capacitors, the output voltage experiences sag. This sag is a direct consequence of the amount of capacitance on the output.

During the removal of the same output load, the energy stored in the inductor is dumped into the output capacitors. This energy dumping creates a temporary hump in the output voltage. This hump, as with the sag, can be attributed to the total amount of capacitance on the output. [Figure 45](#) shows a typical response to a load transient.

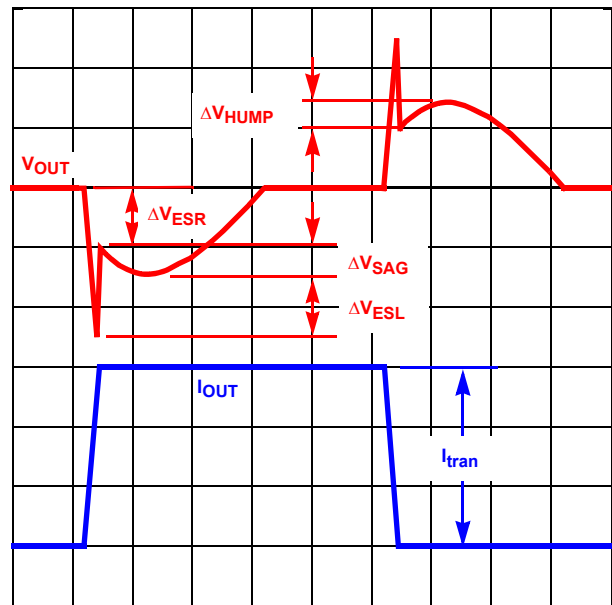

FIGURE 45. TYPICAL TRANSIENT RESPONSE

The amplitudes of the different types of voltage excursions can be approximated using [Equations 6, 7, 8, and 9](#).

$$\Delta V_{ESR} = ESR \cdot I_{tran} \quad (\text{EQ. 6})$$

$$\Delta V_{ESL} = ESL \cdot \frac{di_{tran}}{dt} \quad (\text{EQ. 7})$$

$$\Delta V_{SAG} = \frac{L_{OUT} \cdot I_{tran}^2}{C_{OUT} \cdot (V_{IN} - V_{OUT})} \quad (\text{EQ. 8})$$

$$\Delta V_{\text{HUMP}} = \frac{L_{\text{OUT}} \cdot I_{\text{tran}}^2}{C_{\text{OUT}} \cdot V_{\text{OUT}}} \quad (\text{EQ. 9})$$

where I_{tran} = Output load current transient and C_{OUT} = Total output capacitance.

In a typical converter design, the ESR of the output capacitor bank dominates the transient response. The ESR and the ESL are typically the major contributing factors in determining the output capacitance. The number of output capacitors can be determined by using Equation 10, which relates the ESR and ESL of the capacitors to the transient load step and the voltage limit (ΔV_{O}):

$$\text{Number of Caps} = \frac{\frac{\text{ESL} \cdot I_{\text{tran}}}{dt} + \text{ESR} \cdot I_{\text{tran}}}{\Delta V_{\text{O}}} \quad (\text{EQ. 10})$$

If ΔV_{SAG} or ΔV_{HUMP} are too large for the output voltage limits, then the amount of capacitance may need to be increased. In this situation, a trade-off between output inductance and output capacitance may be necessary.

The ESL of the capacitors, which is an important parameter in the above equations, is not usually listed in the specification. Practically, it can be approximated using Equation 11 if an Impedance vs Frequency curve is given for a specific capacitor:

$$\text{ESL} = \frac{1}{C(2 \cdot \pi \cdot f_{\text{res}})^2} \quad (\text{EQ. 11})$$

where f_{res} is the resonant frequency in which the lowest impedance is achieved.

The ESL of the capacitors becomes a concern when designing circuits that supply power to loads with high rates of change in the current.

Output Inductor Selection

Select the output inductor to meet the output voltage ripple requirements and minimize the converter's response time to the load transient. The inductor value determines the converter's ripple current and the output ripple voltage is a function of the ripple current. The ripple voltage and current are approximated by Equations 12 and 13:

$$\Delta I = \frac{(V_{\text{IN}} - V_{\text{OUT}})}{F_s \cdot L} \cdot \frac{V_{\text{OUT}}}{V_{\text{IN}}} \quad (\text{EQ. 12})$$

$$\Delta V_{\text{OUT}} = \Delta I \times \text{ESR} \quad (\text{EQ. 13})$$

Increasing the inductance value reduces the ripple current and voltage. However, the large inductance values reduce the converter's response time to a load transient. Furthermore, the ripple current is an important signed-in current mode control. Therefore, set the ripple inductor current to approximately 30% of the maximum output current for optimized performance.

One of the parameters limiting the converter's response to a load transient is the time required to change the inductor current. Given a sufficiently fast control loop design, the regulator will provide either 0% or 100% duty cycle in response to a load transient. The response time is the time required to slew the

inductor current from an initial current value to the transient current level. During this interval, the difference between the inductor current and the transient current level must be supplied by the output capacitor. Minimizing the response time can minimize the output capacitance required.

The response time to a transient is different for the application of load and the removal of load. Equations 14 and 15 give the approximate response time interval for application and removal of a transient load:

$$t_{\text{RISE}} = \frac{L \times I_{\text{tran}}}{V_{\text{IN}} - V_{\text{OUT}}} \quad (\text{EQ. 14})$$

$$t_{\text{FALL}} = \frac{L \times I_{\text{tran}}}{V_{\text{OUT}}} \quad (\text{EQ. 15})$$

where I_{tran} is the transient load current step, t_{RISE} is the response time to the application of load, and t_{FALL} is the response time to the removal of load. The worst case response time can be either at the application or removal of load. Check both of these equations at the minimum and maximum output levels for the worst case response time.

Input Capacitor Selection

Use a mix of input bypass capacitors to control the input voltage ripple. Use ceramic capacitors for high frequency decoupling and bulk capacitors to supply the current needed each time the switching MOSFET turns on. Place the ceramic capacitors physically close to the MOSFET VIN pins (switching MOSFET drain) and PGND.

The important parameters for the bulk input capacitance are the voltage rating and the RMS current rating. For reliable operation, select bulk capacitors with voltage and current ratings above the maximum input voltage and largest RMS current required by the circuit. Their voltage rating should be at least 1.25 times greater than the maximum input voltage, while a voltage rating of 1.5 times is a conservative guideline. For most cases, the RMS current rating requirement for the input capacitor of a buck regulator is approximately half the DC load current.

The maximum RMS current required by the regulator may be more closely approximated through Equation 16:

$$I_{\text{RMS(MAX)}} = \sqrt{\frac{V_{\text{OUT}}}{V_{\text{IN}}} \cdot \left(I_{\text{OUT(MAX)}}^2 + \frac{1}{12} \cdot \left(\frac{V_{\text{IN}} - V_{\text{OUT}}}{L \cdot f_s} \cdot \frac{V_{\text{OUT}}}{V_{\text{IN}}} \right)^2 \right)} \quad (\text{EQ. 16})$$

For a through-hole design, several electrolytic capacitors may be needed, especially at temperatures less than -25°C. The electrolytic's ESR can increase ten times higher than at room temperature and cause input line oscillation. In this case, use a more thermally stable capacitor such as X7R ceramic. For surface mount designs, solid tantalum capacitors can be used, but caution must be exercised with regard to the capacitor surge current rating. Some capacitor series available from reputable manufacturers are surge current tested.

Loop Compensation Design

When COMP is not connected to GND, the COMP pin is active for external loop compensation. In an application with extreme temperatures, such as less than -10°C or greater than $+85^{\circ}\text{C}$, use external compensation. The regulator uses constant frequency peak current mode control architecture to achieve a fast loop transient response. An accurate current sensing pilot device in parallel with the upper MOSFET is used for peak current control signal and overcurrent protection. The inductor is not considered a state variable because its peak current is constant, and the system becomes a single order system. It is much easier to design a Type II compensator to stabilize the loop than to implement voltage mode control. Peak current mode control has an inherent input voltage feed-forward function to achieve good line regulation. [Figure 46](#) shows the small signal model of the synchronous buck regulator.

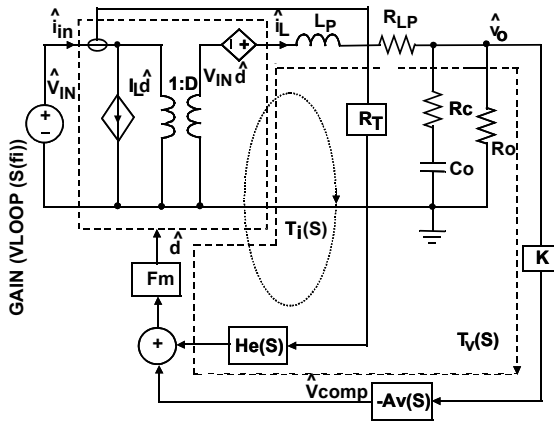

FIGURE 46. SMALL SIGNAL MODEL OF SYNCHRONOUS BUCK REGULATOR

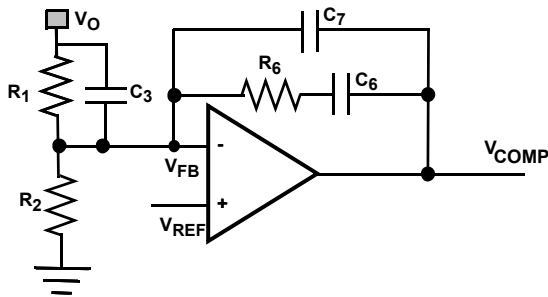

FIGURE 47. TYPE II COMPENSATOR

[Figure 47](#) shows the Type II compensator. Its transfer function is expressed, as shown in [Equation 17](#):

$$A_v(S) = \frac{\hat{v}_{comp}}{\hat{v}_o} = \frac{1}{(C_6 + C_7) \cdot R_1} \frac{\left(1 + \frac{S}{\omega_{cz1}}\right)\left(1 + \frac{S}{\omega_{cz2}}\right)}{S\left(1 + \frac{S}{\omega_{cp1}}\right)\left(1 + \frac{S}{\omega_{cp2}}\right)} \quad (\text{EQ. 17})$$

where:

$$\omega_{cz1} = \frac{1}{R_6 C_6}, \quad \omega_{cz2} = \frac{1}{R_1 C_3}, \quad \omega_{cp1} = \frac{C_6 + C_7}{R_6 C_6 C_7}, \quad \omega_{cp2} \approx 350\text{kHz}$$

Compensator Design Goal

High DC Gain

Choose Loop bandwidth f_c of approximately 50kHz or 1/10 of the switching frequency.

- Gain margin: $>10\text{dB}$
- Phase margin: $>40^{\circ}$

The compensator design procedure is as follows:

The loop gain at crossover frequency of f_c has a unity gain. Therefore, the compensator resistance, R_6 , is determined by [Equation 18](#).

$$R_6 = 2\pi f_c C_o R_t R_1 \approx f_c \cdot C_o R_1 \quad (\text{EQ. 18})$$

Note that C_o is the actual capacitance seen by the regulator, which may include ceramic high frequency decoupling and bulk output capacitors. Ceramic may have to be derated by approximately 40% depending on dielectric, voltage stress, and temperature. Compensator capacitor C_6 is then given by [Equations 19](#) and [20](#).

$$C_6 = \frac{R_o C_o}{10 R_6} = \frac{V_o C_o}{10 I_o R_6} \quad (\text{EQ. 19})$$

$$C_7 = \max\left[\frac{R_c C_o}{10 R_6}, \frac{1}{\pi f_s R_6}\right] \quad (\text{EQ. 20})$$

An optional zero can boost the phase margin. ω_{cz2} is a zero due to R_1 and C_3 .

Put compensator zero, ω_{cz2} from $1/2f_c$ to f_c .

$$C_3 = \frac{1}{2\pi f_c R_1} \quad (\text{EQ. 21})$$

For internal compensation mode, R_6 is equal 600k Ω and C_6 is 30pF. [Equation 18](#) can be rearranged to solve for R_1 .

Layout Considerations

The layout is very important in a high frequency switching converter design. With power devices switching efficiently at 500kHz, the resulting current transitions from one device to another cause voltage spikes across the interconnecting impedances and parasitic circuit elements. These voltage spikes can degrade efficiency, radiate noise into the circuit, and lead to device overvoltage stress. Careful component layout and Printed Circuit Board (PCB) design minimizes these voltage spikes.

A snubber can be added to reduce voltage spikes. The snubber consists of a resistor and a capacitor that are connected in series from the PHASE pin to PGND pin. The snubber damps the voltage ringing caused by parasitic inductance and capacitance. Another option to reduce voltage spikes is to add a boot resistor in series with the boot capacitor, which slows down the turn-on of the high-side FET and allows more time for the parasitic network to discharge.

As an example, consider the turn-off transition of the upper MOSFET. Before turn-off, the MOSFET is carrying the full load

current. During turn-off, current stops flowing in the MOSFET and is picked up by the internal body diode. Any parasitic inductance in the switched current path generates a large voltage spike during the switching interval. Careful component selection, tight layout of the critical components, and short, wide traces minimize the magnitude of voltage spikes.

There are two sets of critical components in the regulator switching converter. The switching components are the most critical because they switch large amounts of energy and therefore tend to generate large amounts of noise. Next are the small signal components, which connect to sensitive nodes or supply critical bypass current and signal coupling.

A multi-layer PCB is recommended. [Figure 48](#) shows the connections of the critical components in the converter. Note that capacitors C_{IN} and C_{OUT} could each represent numerous physical capacitors. Dedicate one solid layer, usually a middle layer of the PCB, for a ground plane and make all critical component ground connections with vias to this layer. Dedicate another solid layer as a power plane and break this plane into smaller islands of common voltage levels. Keep the metal runs from the PHASE terminals to the output inductor short. The power plane should support the input power and output power nodes. Use copper-filled polygons on the top and bottom circuit layers for the phase nodes. Use the remaining printed circuit layers for small signal wiring.

To dissipate heat generated by the internal LDO and MOSFETs, the ground pad should be connected to the internal ground plane through at least five vias. This allows the heat to move away from the IC and ties the pad to the ground plane through a low impedance path.

Place the switching components close to the regulator first. Minimize the length of the connections between the input capacitors, C_{IN} , and the power switches by placing them nearby. Position both the ceramic and bulk input capacitors as close to the upper MOSFET drain as possible.

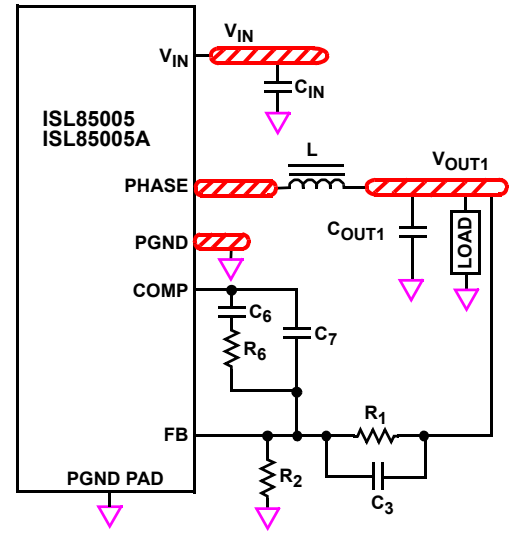

KEY
 ISLAND ON CIRCUIT AND/OR POWER PLANE LAYER
 VIA CONNECTION TO GROUND PLANE

FIGURE 48. PRINTED CIRCUIT BOARD POWER PLANES AND ISLANDS

The critical small signal components include any bypass capacitors, feedback components, and compensation components. Place the compensation components close to the FB and COMP pins. Place the feedback resistors as close as possible to the FB pin with vias tied straight to the ground plane. [Figure 49](#) shows a recommended layout example.

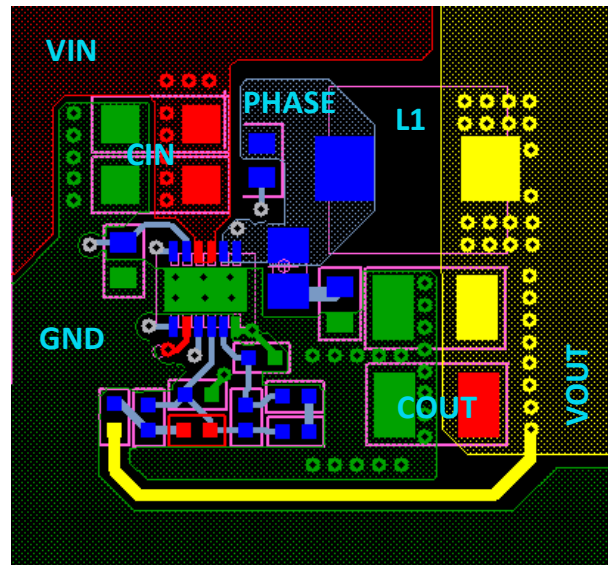

FIGURE 49. RECOMMEND LAYOUT (TOP LAYER)

Revision History The revision history provided is for informational purposes only and is believed to be accurate, however, not warranted. Please visit our website to make sure you have the latest revision.

DATE	REVISION	CHANGE
May 17, 2018	FN8871.2	Updated Pin Configuration labels from "4X3" to "3X4". Updated Ordering information by adding tape and reel parts to table, adding tape and reel quantity column, updating Note 1, adding demonstration board parts. Removed About Intersil section and updated disclaimer.
Aug 17, 2017	FN8871.1	In the Component Selection Table, for C ₁ , changed "15pF" to "12pF" for all voltages. Updated Figures 27-34. Updated Figure 39. In Output Voltage Selection on page 16, changed the maximum value of the feedback resistor from "400kΩ" to "600kΩ". In Layout Considerations on page 19, added the second paragraph, which is a description of a snubber. Updated Figure 49.
Nov 28, 2016	FN8871.0	Initial release

Package Outline Drawing

For the most recent package outline drawing, see [L12.3x4](#).

L12.3x4

12 LEAD DUAL FLAT NO-LEAD PLASTIC PACKAGE

Rev 1, 3/15

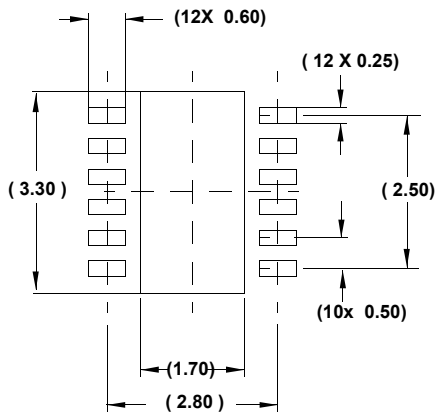
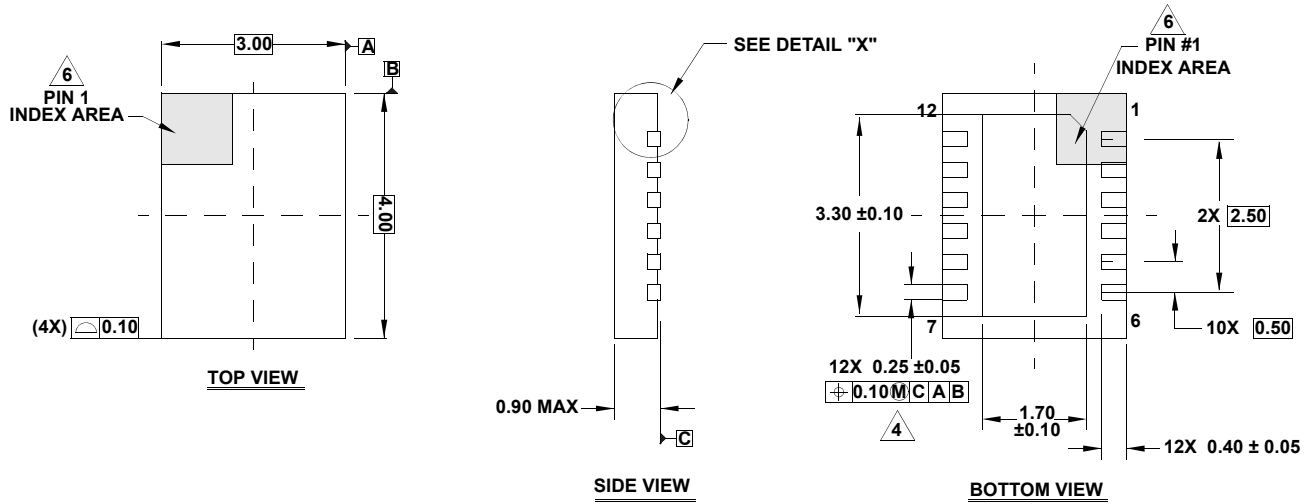

TYPICAL RECOMMENDED LAND PATTERN

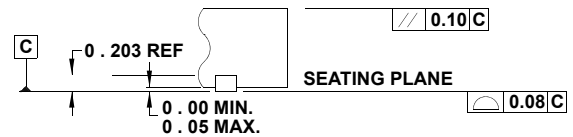

DETAIL "X"

NOTES:

1. Dimensions are in millimeters.
Dimensions in () for Reference Only.
2. Dimensioning and tolerancing conform to ASME Y14.5m-1994.
3. Unless otherwise specified, tolerance : Decimal ± 0.05
4. Dimension applies to the metallized terminal and is measured between 0.15mm and 0.30mm from the terminal tip.
5. Tiebar shown (if present) is a non-functional feature and may be located on any of the 4 sides (or ends).
6. The configuration of the pin #1 identifier is optional, but must be located within the zone indicated. The pin #1 identifier may be either a mold or mark feature.
7. Reference document JEDEC MO-229.

Notice

1. Descriptions of circuits, software and other related information in this document are provided only to illustrate the operation of semiconductor products and application examples. You are fully responsible for the incorporation or any other use of the circuits, software, and information in the design of your product or system. Renesas Electronics disclaims any and all liability for any losses and damages incurred by you or third parties arising from the use of these circuits, software, or information.
2. Renesas Electronics hereby expressly disclaims any warranties against and liability for infringement or any other claims involving patents, copyrights, or other intellectual property rights of third parties, by or arising from the use of Renesas Electronics products or technical information described in this document, including but not limited to, the product data, drawings, charts, programs, algorithms, and application examples.
3. No license, express, implied or otherwise, is granted hereby under any patents, copyrights or other intellectual property rights of Renesas Electronics or others.
4. You shall not alter, modify, copy, or reverse engineer any Renesas Electronics product, whether in whole or in part. Renesas Electronics disclaims any and all liability for any losses or damages incurred by you or third parties arising from such alteration, modification, copying or reverse engineering.
5. Renesas Electronics products are classified according to the following two quality grades: "Standard" and "High Quality". The intended applications for each Renesas Electronics product depends on the product's quality grade, as indicated below.
"Standard": Computers; office equipment; communications equipment; test and measurement equipment; audio and visual equipment; home electronic appliances; machine tools; personal electronic equipment; industrial robots; etc.
"High Quality": Transportation equipment (automobiles, trains, ships, etc.); traffic control (traffic lights); large-scale communication equipment; key financial terminal systems; safety control equipment; etc.
Unless expressly designated as a high reliability product or a product for harsh environments in a Renesas Electronics data sheet or other Renesas Electronics document, Renesas Electronics products are not intended or authorized for use in products or systems that may pose a direct threat to human life or bodily injury (artificial life support devices or systems; surgical implantations; etc.), or may cause serious property damage (space system; undersea repeaters; nuclear power control systems; aircraft control systems; key plant systems; military equipment; etc.). Renesas Electronics disclaims any and all liability for any damages or losses incurred by you or any third parties arising from the use of any Renesas Electronics product that is inconsistent with any Renesas Electronics data sheet, user's manual or other Renesas Electronics document.
6. When using Renesas Electronics products, refer to the latest product information (data sheets, user's manuals, application notes, "General Notes for Handling and Using Semiconductor Devices" in the reliability handbook, etc.), and ensure that usage conditions are within the ranges specified by Renesas Electronics with respect to maximum ratings, operating power supply voltage range, heat dissipation characteristics, installation, etc. Renesas Electronics disclaims any and all liability for any malfunctions, failure or accident arising out of the use of Renesas Electronics products outside of such specified ranges.
7. Although Renesas Electronics endeavors to improve the quality and reliability of Renesas Electronics products, semiconductor products have specific characteristics, such as the occurrence of failure at a certain rate and malfunctions under certain use conditions. Unless designated as a high reliability product or a product for harsh environments in a Renesas Electronics data sheet or other Renesas Electronics document, Renesas Electronics products are not subject to radiation resistance design. You are responsible for implementing safety measures to guard against the possibility of bodily injury, injury or damage caused by fire, and/or danger to the public in the event of a failure or malfunction of Renesas Electronics products, such as safety design for hardware and software, including but not limited to redundancy, fire control and malfunction prevention, appropriate treatment for aging degradation or any other appropriate measures. Because the evaluation of microcomputer software alone is very difficult and impractical, you are responsible for evaluating the safety of the final products or systems manufactured by you.
8. Please contact a Renesas Electronics sales office for details as to environmental matters such as the environmental compatibility of each Renesas Electronics product. You are responsible for carefully and sufficiently investigating applicable laws and regulations that regulate the inclusion or use of controlled substances, including without limitation, the EU RoHS Directive, and using Renesas Electronics products in compliance with all these applicable laws and regulations. Renesas Electronics disclaims any and all liability for damages or losses occurring as a result of your noncompliance with applicable laws and regulations.
9. Renesas Electronics products and technologies shall not be used for or incorporated into any products or systems whose manufacture, use, or sale is prohibited under any applicable domestic or foreign laws or regulations. You shall comply with any applicable export control laws and regulations promulgated and administered by the governments of any countries asserting jurisdiction over the parties or transactions.
10. It is the responsibility of the buyer or distributor of Renesas Electronics products, or any other party who distributes, disposes of, or otherwise sells or transfers the product to a third party, to notify such third party in advance of the contents and conditions set forth in this document.
11. This document shall not be reprinted, reproduced or duplicated in any form, in whole or in part, without prior written consent of Renesas Electronics.
12. Please contact a Renesas Electronics sales office if you have any questions regarding the information contained in this document or Renesas Electronics products.
(Note 1) "Renesas Electronics" as used in this document means Renesas Electronics Corporation and also includes its directly or indirectly controlled subsidiaries.
(Note 2) "Renesas Electronics product(s)" means any product developed or manufactured by or for Renesas Electronics.

(Rev.4.0-1 November 2017)



SALES OFFICES

Renesas Electronics Corporation

<http://www.renesas.com>

Refer to "<http://www.renesas.com/>" for the latest and detailed information.

Renesas Electronics America Inc.
1001 Murphy Ranch Road, Milpitas, CA 95035, U.S.A.
Tel: +1-408-432-8888, Fax: +1-408-434-5351

Renesas Electronics Canada Limited
9251 Yonge Street, Suite 8309 Richmond Hill, Ontario Canada L4C 9T3
Tel: +1-905-237-2004

Renesas Electronics Europe Limited
Dukes Meadow, Millboard Road, Bourne End, Buckinghamshire, SL8 5FH, U.K
Tel: +44-1628-651-700, Fax: +44-1628-651-804

Renesas Electronics Europe GmbH
Arcadiastrasse 10, 40472 Düsseldorf, Germany
Tel: +49-211-6503-0, Fax: +49-211-6503-1327

Renesas Electronics (China) Co., Ltd.
Room 1709 Quantum Plaza, No.27 ZhichunLu, Haidian District, Beijing, 100191 P. R. China
Tel: +86-10-8235-1155, Fax: +86-10-8235-7679

Renesas Electronics (Shanghai) Co., Ltd.
Unit 301, Tower A, Central Towers, 555 Langao Road, Putuo District, Shanghai, 200333 P. R. China
Tel: +86-21-2226-0888, Fax: +86-21-2226-0999

Renesas Electronics Hong Kong Limited
Unit 1601-1611, 16/F., Tower 2, Grand Century Place, 193 Prince Edward Road West, Mongkok, Kowloon, Hong Kong
Tel: +852-2265-6688, Fax: +852-2886-9022

Renesas Electronics Taiwan Co., Ltd.
13F, No. 363, Fu Shing North Road, Taipei 10543, Taiwan
Tel: +886-2-8175-9600, Fax: +886-2-8175-9670

Renesas Electronics Singapore Pte. Ltd.
80 Bendemeer Road, Unit #06-02 Hyflux Innovation Centre, Singapore 339949
Tel: +65-6213-0200, Fax: +65-6213-0300

Renesas Electronics Malaysia Sdn.Bhd.
Unit 1207, Block B, Menara Amcorp, Amcorp Trade Centre, No. 18, Jln Persiaran Barat, 46050 Petaling Jaya, Selangor Darul Ehsan, Malaysia
Tel: +60-3-7955-9390, Fax: +60-3-7955-9510

Renesas Electronics India Pvt. Ltd.
No.777C, 100 Feet Road, HAL 2nd Stage, Indiranagar, Bangalore 560 038, India
Tel: +91-80-67208700, Fax: +91-80-67208777

Renesas Electronics Korea Co., Ltd.
17F, KAMCO Yangjae Tower, 262, Gangnam-daero, Gangnam-gu, Seoul, 06265 Korea
Tel: +82-2-558-3737, Fax: +82-2-558-5338

Looking for pricing, stock, or lifecycle information?

Click below to explore more details on WIN SOURCE:

-  [View ISL85005AFRZ-T7A on WIN SOURCE](#)
-  [Renesas Electronics America](#) Information

Optimize Your Supply Chain with WIN SOURCE Solutions

-  Global Sourcing Solution
-  Obsolete Management
-  Cost Control Management
-  Shortage Management
-  Alternative Solution
-  Excess Inventory Management