



**THE DATASHEET OF
DS10CP152TMA/NOPB**



DS10CP152 1.5 Gbps 2X2 LVDS Crosspoint Switch

Check for Samples: [DS10CP152](#)

FEATURES

- DC - 1.5 Gbps Low Jitter, Low Skew, Low Power Operation
- Pin Configurable, Fully Differential, Non-Blocking Architecture
- Wide Input Common Mode Voltage Range Allows DC-Coupled Interface to LVDS, CML and LVPECL Drivers
- On-chip 100Ω Input and Output Termination Minimizes Insertion and Return Losses, Reduces Component Count and Minimizes Board Space
- 7 kV ESD on LVDS I/O Pins Protects Adjoining Components
- Small SOIC-16 Space Saving Package

DESCRIPTION

The DS10CP152 is a 1.5 Gbps 2x2 LVDS crosspoint switch optimized for high-speed signal routing and switching over lossy FR-4 printed circuit board backplanes and balanced cables. Fully differential signal paths ensure exceptional signal integrity and noise immunity. The non-blocking architecture allows connections of any input to any output or outputs.

Wide input common mode range allows the switch to accept signals with LVDS, CML and LVPECL levels; the output levels are LVDS. A very small package footprint requires a minimal space on the board while the flow-through pinout allows easy board layout. Each differential input and output is internally terminated with a 100Ω resistor to lower device return losses, reduce component count and further minimize board space.

APPLICATIONS

- High-Speed Channel Select Applications
- Clock and Data Buffering and Muxing
- SD/HD SDI Routers

Typical Application

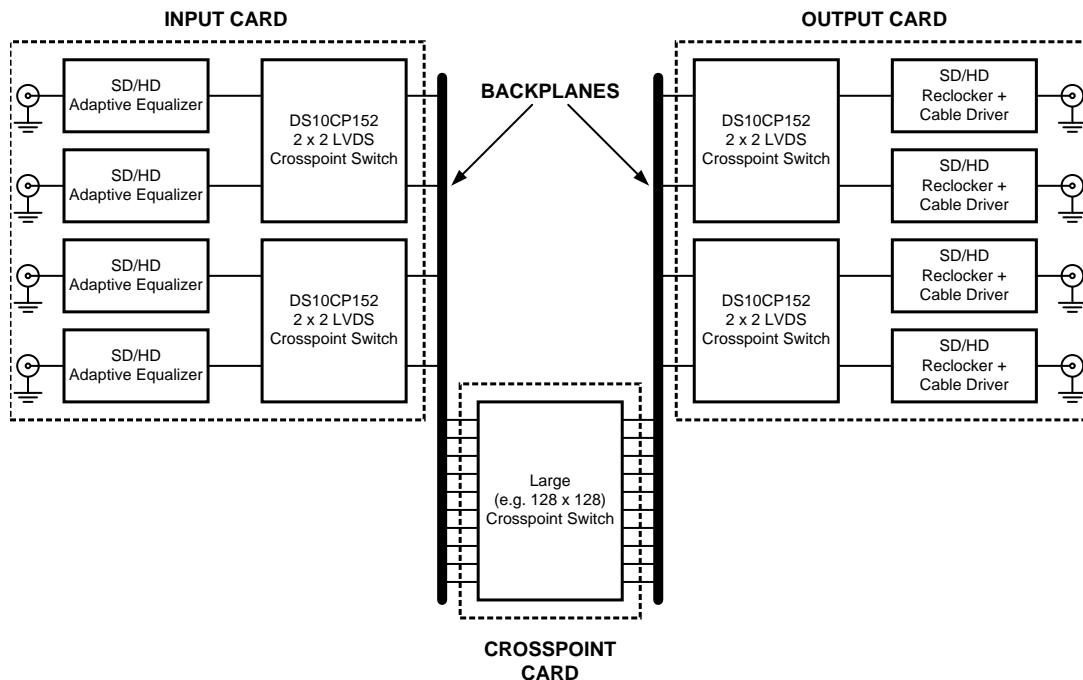

Please be aware that an important notice concerning availability, standard warranty, and use in critical applications of Texas Instruments semiconductor products and disclaimers thereto appears at the end of this data sheet.

All trademarks are the property of their respective owners.

Block Diagram

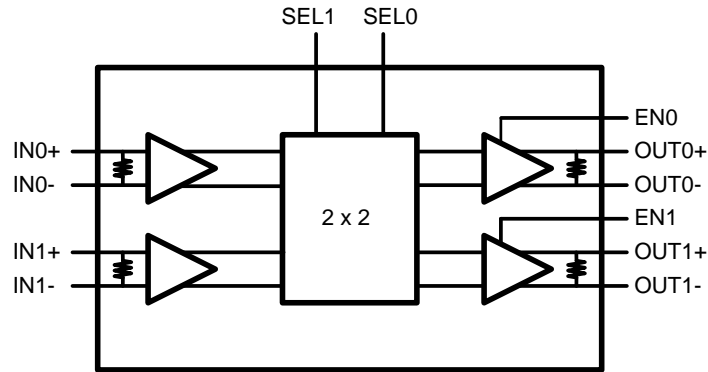

Connection Diagram

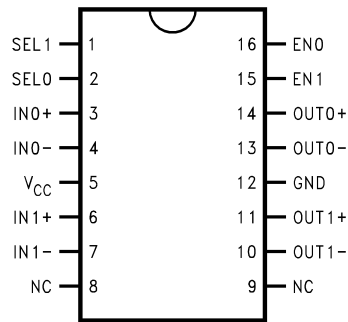

DS10CP152 Pin Diagram
See Package Number D (R-PDSO-G16)

PIN DESCRIPTIONS

Pin Name	Pin Number	I/O, Type	Pin Description
IN0+, IN0- , IN1+, IN1-	3, 4, 6, 7	I, LVDS	Inverting and non-inverting high speed LVDS input pins.
OUT0+, OUT0- , OUT1+, OUT1-	14, 13, 11, 10	O, LVDS	Inverting and non-inverting high speed LVDS output pins.
SEL1, SEL0	1, 2	I, LVCMOS	Switch configuration pins.
EN0, EN1	16, 15	I, LVCMOS	Output enable pins.
NC	8, 9	NC	"NO CONNECT" pins.
VDD	5	Power	Power supply pin.
GND	12	Power	Ground pin.



These devices have limited built-in ESD protection. The leads should be shorted together or the device placed in conductive foam during storage or handling to prevent electrostatic damage to the MOS gates.

Absolute Maximum Ratings ⁽¹⁾⁽²⁾

Supply Voltage	-0.3V to +4V
LVCMOS Input Voltage	-0.3V to ($V_{CC} + 0.3V$)
LVDS Input Voltage	-0.3V to +4V
Differential Input Voltage VID	1V
LVDS Output Voltage	-0.3V to ($V_{CC} + 0.3V$)
LVDS Differential Output Voltage	0V to 1V
LVDS Output Short Circuit Current Duration	5 ms
Junction Temperature	+150°C
Storage Temperature Range	-65°C to +150°C
Lead Temperature Range	
Soldering (4 sec.)	+260°C
Maximum Package Power Dissipation at 25°C	
D Package	1.72W
Derate D Package	13.75 mW/°C above +25°C
Package Thermal Resistance	
θ_{JA}	+72.7°C/W
θ_{JC}	+41.2°C/W
ESD Susceptibility	
HBM ⁽³⁾	≥7 kV
MM ⁽⁴⁾	≥250V
CDM ⁽⁵⁾	≥1250V

- (1) Absolute Maximum Ratings indicate limits beyond which damage to the device may occur, including inoperability and degradation of device reliability and/or performance. Functional operation of the device and/or non-degradation at the Absolute Maximum Ratings or other conditions beyond those indicated in the Recommended Operating Conditions is not implied. The Recommended Operating Conditions indicate conditions at which the device is functional and the device should not be operated beyond such conditions.
- (2) If Military/Aerospace specified devices are required, please contact the Texas Instruments Sales Office/ Distributors for availability and specifications.
- (3) Human Body Model, applicable std. JESD22-A114C
- (4) Machine Model, applicable std. JESD22-A115-A
- (5) Field Induced Charge Device Model, applicable std. JESD22-C101-C

Recommended Operating Conditions

	Min	Typ	Max	Units
Supply Voltage (V_{CC})	3.0	3.3	3.6	V
Receiver Differential Input Voltage (V_{ID})	0		1	V
Operating Free Air Temperature (T_A)	-40	+25	+85	°C

DC Electrical Characteristics

Over recommended operating supply and temperature ranges unless otherwise specified. ⁽¹⁾⁽²⁾⁽³⁾

Symbol	Parameter	Conditions	Min	Typ	Max	Units
LVCMOS DC SPECIFICATIONS						
V _{IH}	High Level Input Voltage		2.0		V _{DD}	V
V _{IL}	Low Level Input Voltage		GND		0.8	V
I _{IH}	High Level Input Current	V _{IN} = 3.6V V _{CC} = 3.6V	40	175	250	μA
I _{IL}	Low Level Input Current	V _{IN} = GND V _{CC} = 3.6V		±1	±10	μA
V _{CL}	Input Clamp Voltage	I _{CL} = -18 mA, V _{CC} = 0V		-0.9	-1.5	V
LVDS INPUT DC SPECIFICATIONS						
V _{ID}	Input Differential Voltage		0		1	V
V _{TH}	Differential Input High Threshold	V _{CM} = +0.05V or V _{CC} -0.05V		0	+100	mV
V _{TL}	Differential Input Low Threshold		-100	0		mV
V _{CMR}	Common Mode Voltage Range	V _{ID} = 100 mV	0.05		V _{CC} - 0.05	V
I _{IN}	Input Current	V _{IN} = 3.6V or 0V V _{CC} = 3.6V or 0V		±1	±10	μA
C _{IN}	Input Capacitance	Any LVDS Input Pin to GND		1.7		pF
R _{IN}	Input Termination Resistor	Between IN+ and IN-		100		Ω
LVDS OUTPUT DC SPECIFICATIONS						
V _{OD}	Differential Output Voltage		250	350	450	mV
ΔV _{OD}	Change in Magnitude of V _{OD} for Complimentary Output States	R _L = 100Ω	-35		35	mV
V _{OS}	Offset Voltage		1.05	1.2	1.375	V
ΔV _{OS}	Change in Magnitude of V _{OS} for Complimentary Output States	R _L = 100Ω	-35		35	mV
I _{OS}	Output Short Circuit Current ⁽⁴⁾	OUT to GND		-23	-55	mA
		OUT to V _{CC}		8	55	mA
C _{OUT}	Output Capacitance	Any LVDS Output Pin to GND		1.2		pF
R _{OUT}	Output Termination Resistor	Between OUT+ and OUT-		100		Ω
SUPPLY CURRENT						
I _{CC}	Supply Current	EN0 = EN1 = H		58	70	mA
I _{CCZ}	Outputs Powered Down Supply Current	EN0 = EN1 = L		25	30	mA

- (1) The [Electrical Characteristics](#) tables list ensured specifications under the listed Recommended Operating Conditions except as otherwise modified or specified by the Electrical Characteristics Conditions and/or Notes. Typical specifications are estimations only and are not ensured.
- (2) Current into device pins is defined as positive. Current out of device pins is defined as negative. All voltages are referenced to ground except V_{OD} and ΔV_{OD}.
- (3) Typical values represent most likely parametric norms for V_{CC} = +3.3V and T_A = +25°C, and at the Recommended Operation Conditions at the time of product characterization and are not ensured.
- (4) Output short circuit current (I_{OS}) is specified as magnitude only, minus sign indicates direction only.

AC Electrical Characteristics

 Over recommended operating supply and temperature ranges unless otherwise specified. ⁽¹⁾⁽²⁾

Symbol	Parameter	Conditions	Min	Typ	Max	Units	
LVDS OUTPUT AC SPECIFICATIONS							
t_{PLHD}	Differential Propagation Delay Low to High ⁽³⁾	$R_L = 100\Omega$		440	650	ps	
t_{PHLD}	Differential Propagation Delay High to Low ⁽³⁾			400	650	ps	
t_{SKD1}	Pulse Skew $ t_{PLHD} - t_{PHLD} $ ^{(3) (4)}			40	120	ps	
t_{SKD2}	Channel to Channel Skew ⁽³⁾⁽⁵⁾			25	60	ps	
t_{SKD3}	Part to Part Skew ⁽³⁾⁽⁶⁾			45	190	ps	
t_{LHT}	Rise Time ⁽³⁾	$R_L = 100\Omega$		170	350	ps	
t_{HLT}	Fall Time ⁽³⁾			170	350	ps	
t_{ON}	Output Enable Time			5	20	μ s	
t_{OFF}	Output Disable Time			3	12	ns	
t_{SEL}	Select Time			3	12	ns	
JITTER PERFORMANCE ⁽³⁾							
t_{RJ1}	Random Jitter (RMS Value) ⁽⁷⁾	$V_{ID} = 350\text{ mV}$ $V_{CM} = 1.2\text{ V}$ Clock (RZ)	135 MHz		0.5	1.2	ps
t_{RJ2}			311 MHz		0.5	1.2	ps
t_{RJ3}			503 MHz		0.5	1.2	ps
t_{RJ4}			750 MHz		0.5	1.2	ps
t_{DJ1}	Deterministic Jitter (Peak-to-Peak Value) ⁽⁸⁾	$V_{ID} = 350\text{ mV}$ $V_{CM} = 1.2\text{ V}$ Clock (RZ)	270 Mbps		9	38	ps
t_{DJ2}			622 Mbps		7	36	ps
t_{DJ3}			1.06 Gbps		7	34	ps
t_{DJ4}			1.5 Gbps		9	35	ps
t_{TJ1}	Total Jitter (Peak to Peak Value) ⁽⁹⁾	$V_{ID} = 350\text{ mV}$ $V_{CM} = 1.2\text{ V}$ PRBS-23 (NRZ)	270 Mbps		0.01	0.03	UI _{P-P}
t_{TJ2}			622 Mbps		0.01	0.04	UI _{P-P}
t_{TJ3}			1.06 Gbps		0.01	0.05	UI _{P-P}
t_{TJ4}			1.5 Gbps		0.01	0.07	UI _{P-P}

- (1) The [Electrical Characteristics](#) tables list ensured specifications under the listed Recommended Operating Conditions except as otherwise modified or specified by the Electrical Characteristics Conditions and/or Notes. Typical specifications are estimations only and are not ensured.
- (2) Typical values represent most likely parametric norms for $V_{CC} = +3.3\text{V}$ and $T_A = +25^\circ\text{C}$, and at the Recommended Operation Conditions at the time of product characterization and are not ensured.
- (3) Specification is ensured by characterization and is not tested in production.
- (4) t_{SKD1} , $|t_{PLHD} - t_{PHLD}|$, Pulse Skew, is the magnitude difference in differential propagation delay time between the positive going edge and the negative going edge of the same channel.
- (5) t_{SKD2} , Channel to Channel Skew, is the difference in propagation delay (t_{PLHD} or t_{PHLD}) among all output channels in Broadcast mode (any one input to all outputs).
- (6) t_{SKD3} , Part to Part Skew, is defined as the difference between the minimum and maximum differential propagation delays. This specification applies to devices at the same V_{CC} and within 5°C of each other within the operating temperature range.
- (7) Measured on a clock edge with a histogram and an accumulation of 1500 histogram hits. Input stimulus jitter is subtracted geometrically.
- (8) Tested with a combination of the 1100000101 (K28.5+ character) and 0011111010 (K28.5- character) patterns. Input stimulus jitter is subtracted algebraically.
- (9) Measured on an eye diagram with a histogram and an accumulation of 3500 histogram hits. Input stimulus jitter is subtracted.

DC Test Circuits

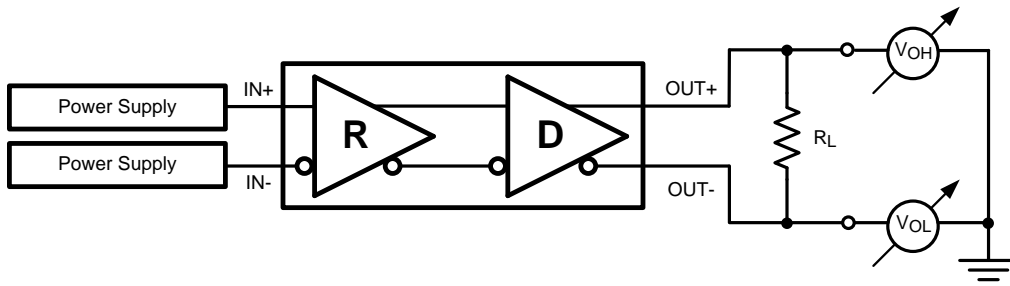

Figure 1.

AC Test Circuits and Timing Diagrams

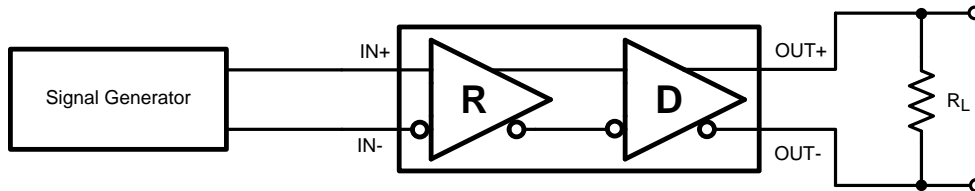

Figure 2.

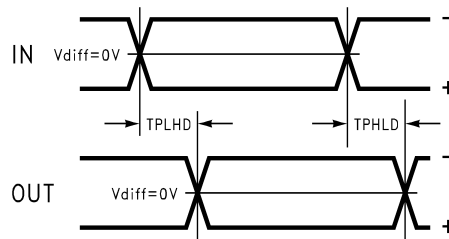

Figure 3.

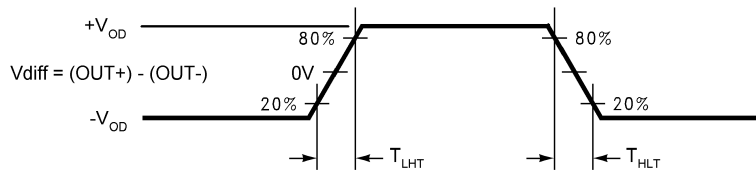

Figure 4.

FUNCTIONAL DESCRIPTION

The DS10CP152 is a 1.5 Gbps 2x2 LVDS digital crosspoint switch optimized for high-speed signal routing and switching over lossy FR-4 printed circuit board backplanes and balanced cables.

Table 1. Switch Configuration Truth Table

SEL1	SEL0	OUT1	OUT0
0	0	IN0	IN0
0	1	IN0	IN1
1	0	IN1	IN0
1	1	IN1	IN1

Table 2. Output Enable Truth Table

EN1	EN0	OUT1	OUT0
0	0	Disabled	Disabled
0	1	Disabled	Enabled
1	0	Enabled	Disabled
1	1	Enabled	Enabled

Input Interfacing

The DS10CP152 accepts differential signals and allows simple AC or DC coupling. With a wide common mode range, the DS10CP152 can be DC-coupled with all common differential drivers (i.e. LVPECL, LVDS, CML). The following three figures illustrate typical DC-coupled interface to common differential drivers. Note that the DS10CP152 inputs are internally terminated with a 100Ω resistor.

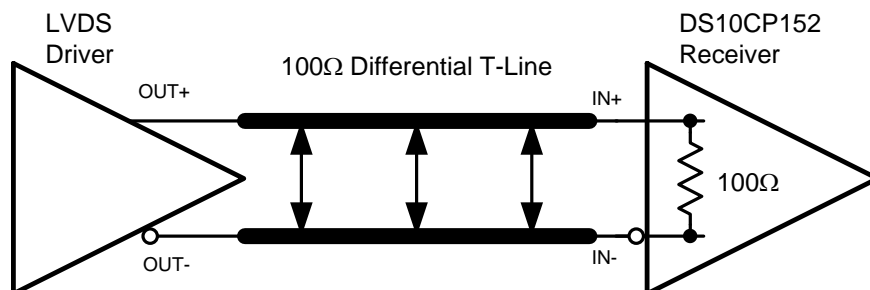

Figure 5. Typical LVDS Driver DC-Coupled Interface to an DS10CP152 Input

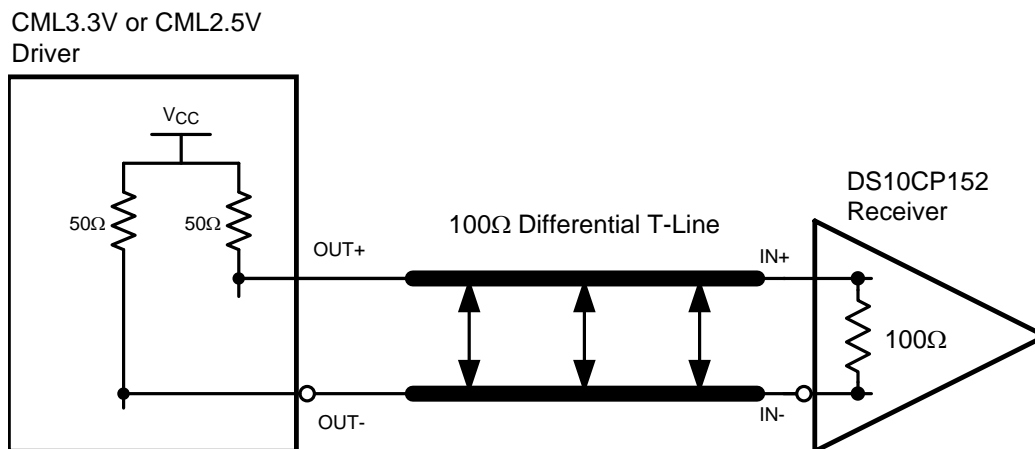

Figure 6. Typical CML Driver DC-Coupled Interface to an DS10CP152 Input

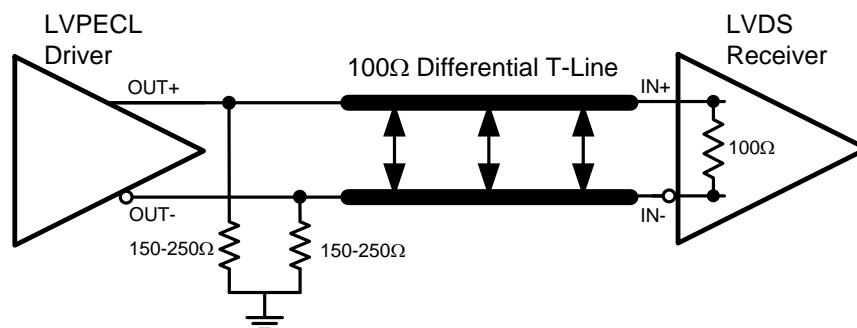

Figure 7. Typical LVPECL Driver DC-Coupled Interface to an DS10CP152 Input

Output Interfacing

The DS10CP152 outputs signals compliant to the LVDS standard. Its outputs can be DC-coupled to most common differential receivers. The following figure illustrates typical DC-coupled interface to common differential receivers and assumes that the receivers have high impedance inputs. While most differential receivers have a common mode input range that can accommodate LVDS compliant signals, it is recommended to check respective receiver's data sheet prior to implementing the suggested interface implementation.

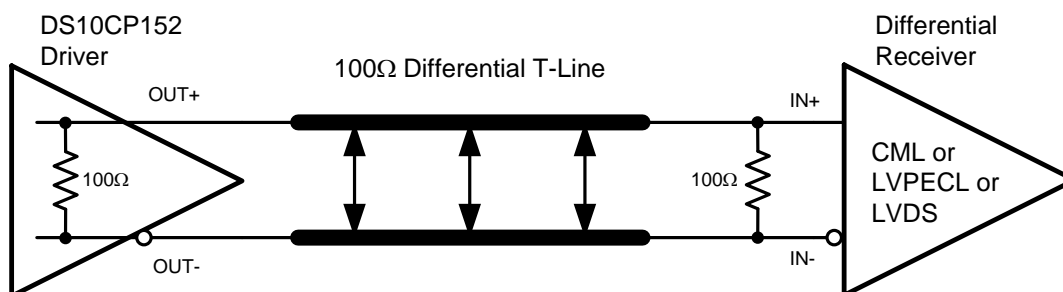
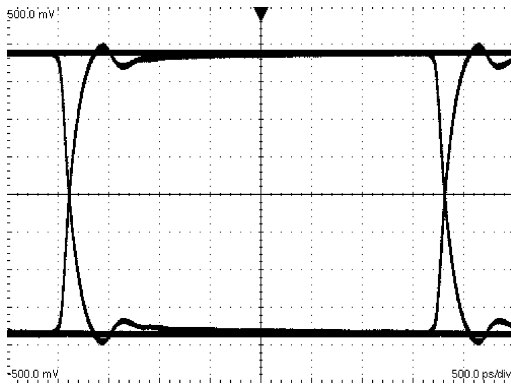
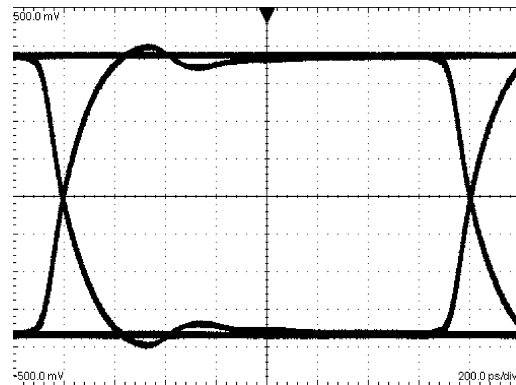

Figure 8. Typical DS10CP152 Output DC-Coupled Interface to an LVDS, CML or LVPECL Receiver

Typical Performance Characteristics



**Figure 9. A 270 Mbps NRZ PRBS-7 After 2"
Differential FR-4 Stripline
V:100 mV / DIV, H:500 ps / DIV**



**Figure 10. A 622 Mbps NRZ PRBS-7 After 2"
Differential FR-4 Stripline
V:100 mV / DIV, H:200 ps / DIV**

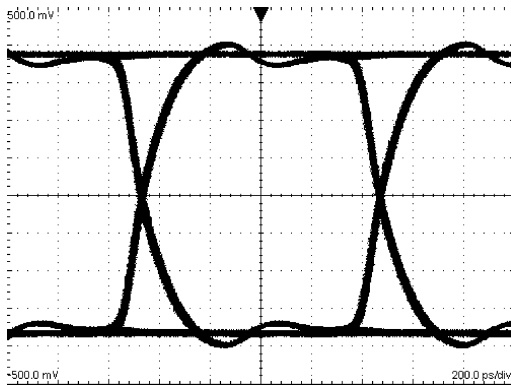

**Figure 11. A 1.06 Gbps NRZ PRBS-7 After 2"
Differential FR-4 Stripline
V:100 mV / DIV, H:200 ps / DIV**

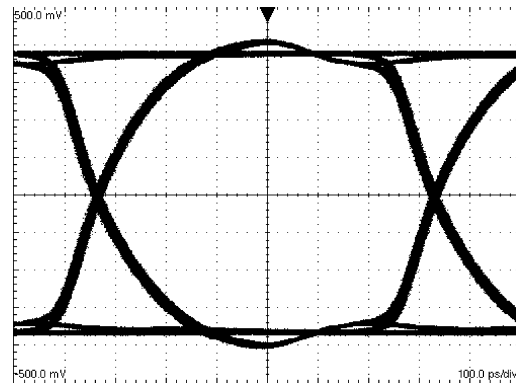

**Figure 12. A 1.5 Gbps NRZ PRBS-7 After 2"
Differential FR-4 Stripline
V:100 mV / DIV, H:100 ps / DIV**

REVISION HISTORY

Changes from Revision D (April 2013) to Revision E	Page
• Changed layout of National Data Sheet to TI format	9

PACKAGING INFORMATION

Orderable Device	Status (1)	Package Type	Package Drawing	Pins	Package Qty	Eco Plan (2)	Lead/Ball Finish	MSL Peak Temp (3)	Op Temp (°C)	Top-Side Markings (4)	Samples
DS10CP152TMA/NOPB	ACTIVE	SOIC	D	16	48	Green (RoHS & no Sb/Br)	CU SN	Level-1-260C-UNLIM	-40 to 85	DS10CP152 TMA	Samples
DS10CP152TMAX/NOPB	ACTIVE	SOIC	D	16	2500	Green (RoHS & no Sb/Br)	CU SN	Level-1-260C-UNLIM	-40 to 85	DS10CP152 TMA	Samples

(1) The marketing status values are defined as follows:

ACTIVE: Product device recommended for new designs.

LIFEBUY: TI has announced that the device will be discontinued, and a lifetime-buy period is in effect.

NRND: Not recommended for new designs. Device is in production to support existing customers, but TI does not recommend using this part in a new design.

PREVIEW: Device has been announced but is not in production. Samples may or may not be available.

OBSOLETE: TI has discontinued the production of the device.

(2) Eco Plan - The planned eco-friendly classification: Pb-Free (RoHS), Pb-Free (RoHS Exempt), or Green (RoHS & no Sb/Br) - please check <http://www.ti.com/productcontent> for the latest availability information and additional product content details.

TBD: The Pb-Free/Green conversion plan has not been defined.

Pb-Free (RoHS): TI's terms "Lead-Free" or "Pb-Free" mean semiconductor products that are compatible with the current RoHS requirements for all 6 substances, including the requirement that lead not exceed 0.1% by weight in homogeneous materials. Where designed to be soldered at high temperatures, TI Pb-Free products are suitable for use in specified lead-free processes.

Pb-Free (RoHS Exempt): This component has a RoHS exemption for either 1) lead-based flip-chip solder bumps used between the die and package, or 2) lead-based die adhesive used between the die and leadframe. The component is otherwise considered Pb-Free (RoHS compatible) as defined above.

Green (RoHS & no Sb/Br): TI defines "Green" to mean Pb-Free (RoHS compatible), and free of Bromine (Br) and Antimony (Sb) based flame retardants (Br or Sb do not exceed 0.1% by weight in homogeneous material)

(3) MSL, Peak Temp. -- The Moisture Sensitivity Level rating according to the JEDEC industry standard classifications, and peak solder temperature.

(4) Multiple Top-Side Markings will be inside parentheses. Only one Top-Side Marking contained in parentheses and separated by a "~" will appear on a device. If a line is indented then it is a continuation of the previous line and the two combined represent the entire Top-Side Marking for that device.

Important Information and Disclaimer: The information provided on this page represents TI's knowledge and belief as of the date that it is provided. TI bases its knowledge and belief on information provided by third parties, and makes no representation or warranty as to the accuracy of such information. Efforts are underway to better integrate information from third parties. TI has taken and continues to take reasonable steps to provide representative and accurate information but may not have conducted destructive testing or chemical analysis on incoming materials and chemicals. TI and TI suppliers consider certain information to be proprietary, and thus CAS numbers and other limited information may not be available for release.

In no event shall TI's liability arising out of such information exceed the total purchase price of the TI part(s) at issue in this document sold by TI to Customer on an annual basis.

TAPE AND REEL INFORMATION



QUADRANT ASSIGNMENTS FOR PIN 1 ORIENTATION IN TAPE



*All dimensions are nominal

Device	Package Type	Package Drawing	Pins	SPQ	Reel Diameter (mm)	Reel Width W1 (mm)	A0 (mm)	B0 (mm)	K0 (mm)	P1 (mm)	W (mm)	Pin1 Quadrant
DS10CP152TMAX/NOPB	SOIC	D	16	2500	330.0	16.4	6.5	10.3	2.3	8.0	16.0	Q1

TAPE AND REEL BOX DIMENSIONS



*All dimensions are nominal

Device	Package Type	Package Drawing	Pins	SPQ	Length (mm)	Width (mm)	Height (mm)
DS10CP152TMAX/NOPB	SOIC	D	16	2500	367.0	367.0	35.0

D (R-PDSO-G16)

PLASTIC SMALL OUTLINE



4040047-6/M 06/11

- NOTES:
- A. All linear dimensions are in inches (millimeters).
 - B. This drawing is subject to change without notice.
 -  C. Body length does not include mold flash, protrusions, or gate burrs. Mold flash, protrusions, or gate burrs shall not exceed 0.006 (0,15) each side.
 -  D. Body width does not include interlead flash. Interlead flash shall not exceed 0.017 (0,43) each side.
 - E. Reference JEDEC MS-012 variation AC.

IMPORTANT NOTICE

Texas Instruments Incorporated and its subsidiaries (TI) reserve the right to make corrections, enhancements, improvements and other changes to its semiconductor products and services per JESD46, latest issue, and to discontinue any product or service per JESD48, latest issue. Buyers should obtain the latest relevant information before placing orders and should verify that such information is current and complete. All semiconductor products (also referred to herein as "components") are sold subject to TI's terms and conditions of sale supplied at the time of order acknowledgment.

TI warrants performance of its components to the specifications applicable at the time of sale, in accordance with the warranty in TI's terms and conditions of sale of semiconductor products. Testing and other quality control techniques are used to the extent TI deems necessary to support this warranty. Except where mandated by applicable law, testing of all parameters of each component is not necessarily performed.

TI assumes no liability for applications assistance or the design of Buyers' products. Buyers are responsible for their products and applications using TI components. To minimize the risks associated with Buyers' products and applications, Buyers should provide adequate design and operating safeguards.

TI does not warrant or represent that any license, either express or implied, is granted under any patent right, copyright, mask work right, or other intellectual property right relating to any combination, machine, or process in which TI components or services are used. Information published by TI regarding third-party products or services does not constitute a license to use such products or services or a warranty or endorsement thereof. Use of such information may require a license from a third party under the patents or other intellectual property of the third party, or a license from TI under the patents or other intellectual property of TI.

Reproduction of significant portions of TI information in TI data books or data sheets is permissible only if reproduction is without alteration and is accompanied by all associated warranties, conditions, limitations, and notices. TI is not responsible or liable for such altered documentation. Information of third parties may be subject to additional restrictions.

Resale of TI components or services with statements different from or beyond the parameters stated by TI for that component or service voids all express and any implied warranties for the associated TI component or service and is an unfair and deceptive business practice. TI is not responsible or liable for any such statements.

Buyer acknowledges and agrees that it is solely responsible for compliance with all legal, regulatory and safety-related requirements concerning its products, and any use of TI components in its applications, notwithstanding any applications-related information or support that may be provided by TI. Buyer represents and agrees that it has all the necessary expertise to create and implement safeguards which anticipate dangerous consequences of failures, monitor failures and their consequences, lessen the likelihood of failures that might cause harm and take appropriate remedial actions. Buyer will fully indemnify TI and its representatives against any damages arising out of the use of any TI components in safety-critical applications.

In some cases, TI components may be promoted specifically to facilitate safety-related applications. With such components, TI's goal is to help enable customers to design and create their own end-product solutions that meet applicable functional safety standards and requirements. Nonetheless, such components are subject to these terms.

No TI components are authorized for use in FDA Class III (or similar life-critical medical equipment) unless authorized officers of the parties have executed a special agreement specifically governing such use.

Only those TI components which TI has specifically designated as military grade or "enhanced plastic" are designed and intended for use in military/aerospace applications or environments. Buyer acknowledges and agrees that any military or aerospace use of TI components which have **not** been so designated is solely at the Buyer's risk, and that Buyer is solely responsible for compliance with all legal and regulatory requirements in connection with such use.

TI has specifically designated certain components as meeting ISO/TS16949 requirements, mainly for automotive use. In any case of use of non-designated products, TI will not be responsible for any failure to meet ISO/TS16949.

Products

Audio	www.ti.com/audio
Amplifiers	amplifier.ti.com
Data Converters	dataconverter.ti.com
DLP® Products	www.dlp.com
DSP	dsp.ti.com
Clocks and Timers	www.ti.com/clocks
Interface	interface.ti.com
Logic	logic.ti.com
Power Mgmt	power.ti.com
Microcontrollers	microcontroller.ti.com
RFID	www.ti-rfid.com
OMAP Applications Processors	www.ti.com/omap
Wireless Connectivity	www.ti.com/wirelessconnectivity

Applications

Automotive and Transportation	www.ti.com/automotive
Communications and Telecom	www.ti.com/communications
Computers and Peripherals	www.ti.com/computers
Consumer Electronics	www.ti.com/consumer-apps
Energy and Lighting	www.ti.com/energy
Industrial	www.ti.com/industrial
Medical	www.ti.com/medical
Security	www.ti.com/security
Space, Avionics and Defense	www.ti.com/space-avionics-defense
Video and Imaging	www.ti.com/video

TI E2E Community

e2e.ti.com

Looking for pricing, stock, or lifecycle information?

Click below to explore more details on WIN SOURCE:

 [View DS10CP152TMA/NOPB on WIN SOURCE](#)

 [Texas Instruments](#) Information

Optimize Your Supply Chain with WIN SOURCE Solutions

-  Global Sourcing Solution
-  Obsolete Management
-  Cost Control Management
-  Shortage Management
-  Alternative Solution
-  Excess Inventory Management