



THE DATASHEET OF 390KD20



DATA SHEET

METAL OXIDE VARISTORS POWER SUPPLY

20D series

RoHS compliant & Halogen free



Product specification— April 11, 2022 V.2



Metal Oxide Varistor (MOV) Data Sheet

Features

- Wide operating voltage (V_{1mA}) range from 18V to 1800V
- Fast responding to transient over-voltage
- Large absorbing transient energy capability
- Low clamping ratio and no follow-on current
- Meets MSL level 1, per J-STD-020
- Operating Temperature: $-40^{\circ}\text{C} \sim +105^{\circ}\text{C}$
- Storage Temperature: $-40^{\circ}\text{C} \sim +125^{\circ}\text{C}$
- Safety certification: UL、CSA、VDE

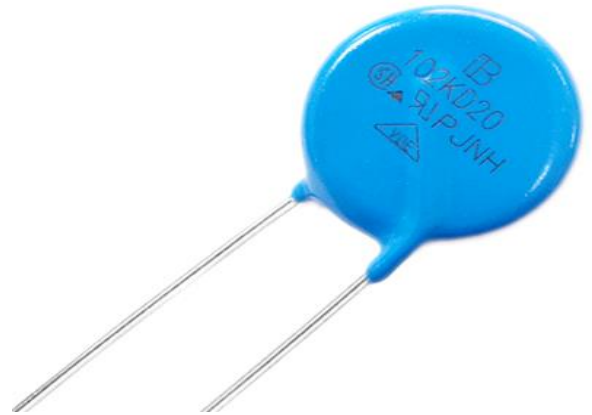

Applications

- Transistor, diode, IC, thyristor or triac semiconductor protection
- Surge protection in consumer electronics
- Surge protection in industrial electronics
- Surge protection in electronic home appliances, gas and petroleum appliances
- Relay and electromagnetic valve surge absorption

Part Number Code

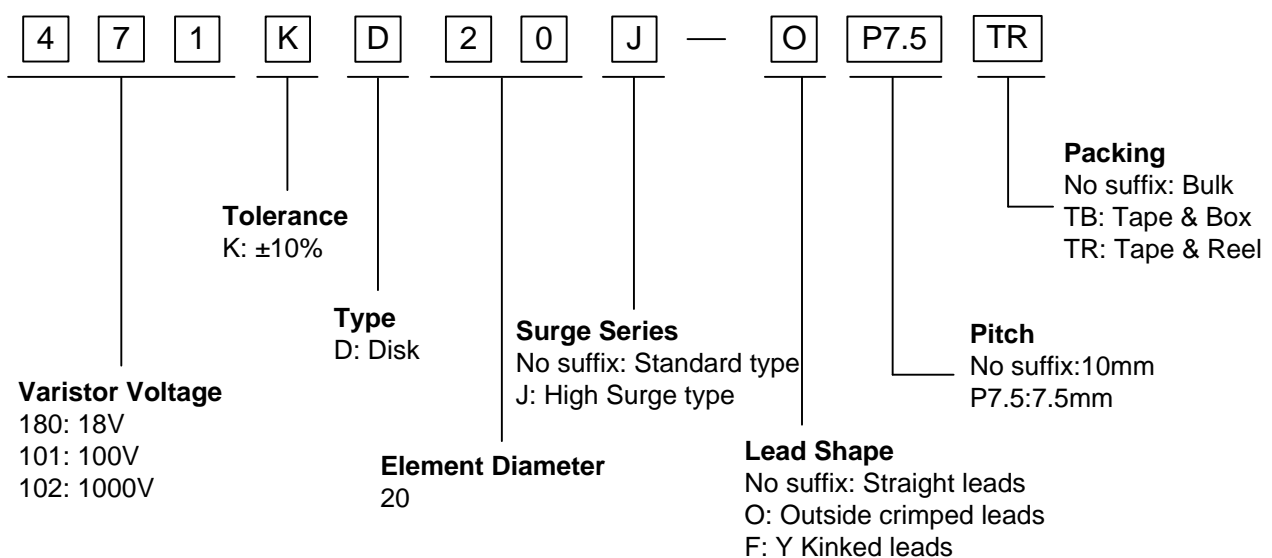

Dimensions



Notes: Varistor voltage $\geq 1200V$, structure diagram is F type.

Table 1	
Unit: mm	
Symbol	Dimension
H	21.0~26.0
H1	24.0~28.0
L(min.)	20.0
L1(min.)	15.0
D	20.0~23.0
F	7.5±0.8/10.0±1.0
T	Table 2
e(±0.8)	Table 2
d(±0.05)	0.8/1.0
d1(±0.4)	1.4/1.6

Table 2					
Unit: mm					
Model	T	e	Model	T	e
180K	2.1~4.3	1.7	361K	3.0~5.4	2.9
220K	2.2~4.4	1.8	391K	3.1~5.5	3.0
270K	2.2~4.6	2.0	431K	3.3~5.7	3.2
330K	2.3~4.8	1.9	471K	3.4~6.0	3.4
390K	2.2~4.5	2.0	511K	3.5~6.2	3.6
470K	2.3~4.7	2.1	561K	3.7~6.5	3.8
560K	2.4~5.0	2.3	621K	3.9~6.8	4.1
680K	2.5~5.3	2.6	681K	4.1~7.1	4.4
820K	2.2~4.5	2.0	751K	4.4~7.5	4.5
101K	2.5~4.6	2.2	781K	4.5~7.7	4.6
121K	2.5~4.8	2.4	821K	4.7~7.9	4.8
151K	2.3~4.5	2.0	911K	4.9~8.1	5.2
181K	2.4~4.6	2.1	102K	5.5~8.6	5.2
201K	2.5~4.7	2.2	112K	5.9~9.1	5.6
221K	2.6~4.8	2.3	122K	6.0~9.7	6.0
241K	2.7~4.9	2.4	142K	7.0~11.2	6.8
271K	2.7~5.0	2.6	162K	7.5~11.8	7.6
301K	2.8~5.0	2.7	182K	7.7~12.8	8.4
331K	2.8~5.2	2.7			

Electrical Characteristics

Part Number		Maximum Allowable Voltage		Varistor Voltage	Maximum Clamping Voltage		Withstanding Surge Current		Maximum Energy (10/1000µs)		Rated Power	Typical Capacitance (Reference)
Standard	High Surge	V _{AC} (V)	V _{DC} (V)	V _{1mA} (V)	I _p (A)	V _c (V)	I (A) Standard	I (A) High Surge	(J) Standard	(J) High Surge	(W)	@1KHz (pf)
180KD20	180KD20J	11	14	18(15~21.6)	20	36	2000	3000	11	13	0.2	28500
220KD20	220KD20J	14	18	22(19.5~26)	20	43	2000	3000	14	16	0.2	18500
270KD20	270KD20J	17	22	27(24~31)	20	53	2000	3000	16	19	0.2	13000
330KD20	330KD20J	20	26	33(29.5~36.5)	20	65	2000	3000	23	24	0.2	11500
390KD20	390KD20J	25	31	39(35~43)	20	77	2000	3000	26	28	0.2	8500
470KD20	470KD20J	30	38	47(42~52)	20	93	2000	3000	30	34	0.2	7400
560KD20	560KD20J	35	45	56(50~62)	20	110	2000	3000	38	44	0.2	6500
680KD20	680KD20J	40	56	68(61~75)	20	135	2000	3000	41	49	0.2	5800
820KD20	820KD20J	50	65	82(74~90)	100	135	6500	10000	45	56	1.0	4900
101KD20	101KD20J	60	85	100(90~110)	100	165	6500	10000	50	70	1.0	4000
121KD20	121KD20J	75	100	120(108~132)	100	200	6500	10000	55	85	1.0	3300
151KD20	151KD20J	95	125	150(135~165)	100	250	6500	10000	70	106	1.0	2700
181KD20	181KD20J	115	150	180(162~198)	100	300	6500	10000	85	130	1.0	2200
201KD20	201KD20J	130	170	200(180~220)	100	340	6500	10000	95	140	1.0	2000
221KD20	221KD20J	140	180	220(198~242)	100	360	6500	10000	100	155	1.0	1800
241KD20	241KD20J	150	200	240(216~264)	100	395	6500	10000	108	168	1.0	1650
271KD20	271KD20J	175	225	270(243~297)	100	455	6500	10000	127	190	1.0	1500
301KD20	301KD20J	190	250	300(270~330)	100	500	6500	10000	136	210	1.0	1300
331KD20	331KD20J	210	275	330(297~363)	100	550	6500	10000	150	228	1.0	1200
361KD20	361KD20J	230	300	360(324~396)	100	595	6500	10000	163	255	1.0	1100
391KD20	391KD20J	250	320	390(351~429)	100	650	6500	10000	180	275	1.0	1000
431KD20	431KD20J	275	350	430(387~473)	100	710	6500	10000	190	305	1.0	930
471KD20	471KD20J	300	385	470(423~517)	100	775	6500	10000	204	350	1.0	850
511KD20	511KD20J	320	415	510(459~561)	100	845	6500	10000	210	360	1.0	780
561KD20	561KD20J	350	460	560(504~616)	100	925	6500	10000	215	380	1.0	710
621KD20	621KD20J	385	505	620(558~682)	100	1025	6500	10000	224	390	1.0	650
681KD20	681KD20J	420	560	680(612~748)	100	1120	6500	10000	230	400	1.0	600
751KD20	751KD20J	460	615	750(675~825)	100	1240	6500	10000	255	420	1.0	530
781KD20	781KD20J	485	640	780(702~858)	100	1290	6500	10000	265	440	1.0	510
821KD20	821KD20J	510	670	820(738~902)	100	1355	6500	10000	282	460	1.0	500
911KD20	911KD20J	550	745	910(819~1001)	100	1500	6500	10000	310	510	1.0	440
102KD20	102KD20J	625	825	1000(900~1100)	100	1650	6500	10000	342	565	1.0	400
112KD20	112KD20J	680	895	1100(990~1210)	100	1815	6500	10000	383	620	1.0	360
122KD20	122KD20J	750	990	1200(1080~1320)	100	1980	6500	10000	408	660	1.0	350
142KD20	142KD20J	880	1140	1400(1260~1540)	100	2310	6500	10000	532	784	1.0	340
162KD20	162KD20J	1000	1280	1600(1440~1760)	100	2640	6500	10000	606	896	1.0	330
182KD20	182KD20J	1100	1465	1800(1620~1980)	100	2970	6500	10000	625	990	1.0	320

Notes: 1. The tolerance of varistor voltage between 18V and 27V is more than 10%;

2. Varistor voltage $\geq 1200V$, structure diagram is F type;

3. Leakage Current (@83% of V_{1mA}): $IR \leq 50\mu A$ (180K~680K) ; $IR \leq 25\mu A$ (820K~182K).

Maximum Surge Current Derating Curve

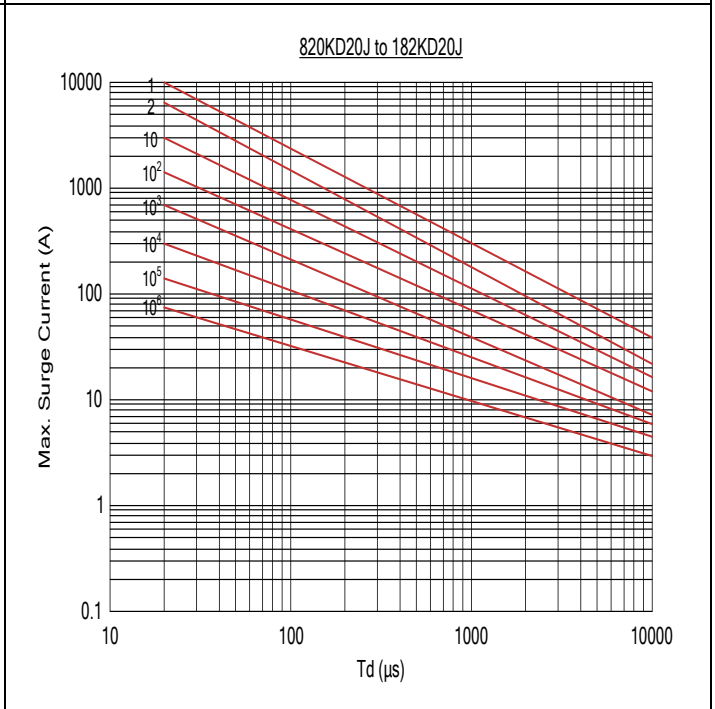
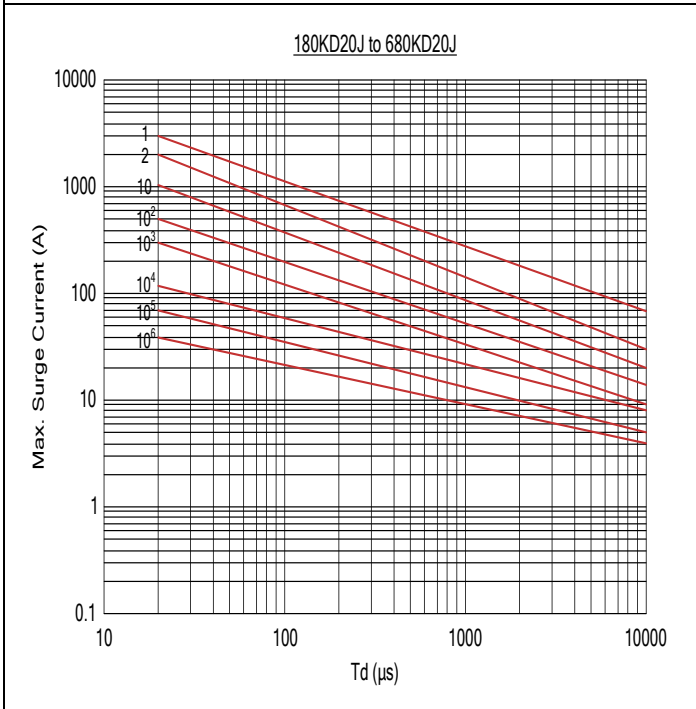
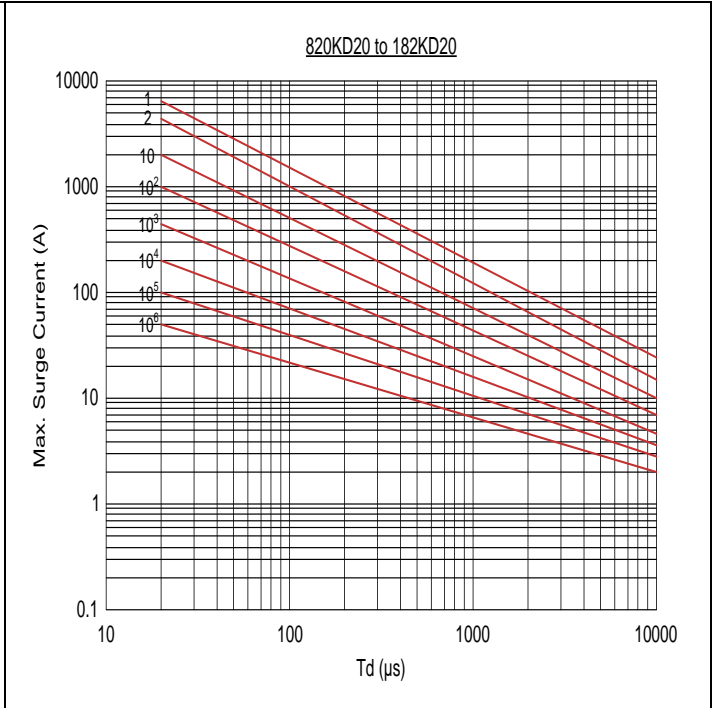
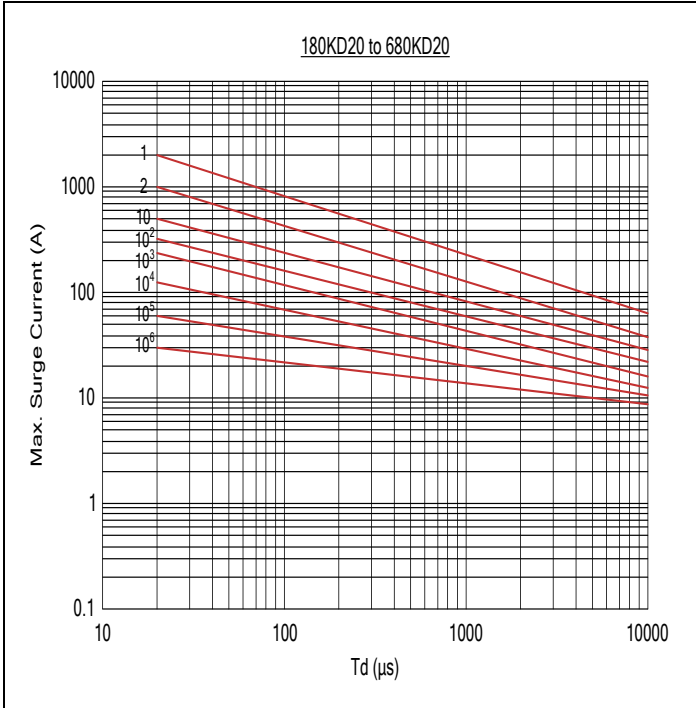

Maximum Leakage Current and Maximum Clamping Voltage Curve



Maximum Leakage Current and Maximum Clamping Voltage Curve



Maximum Leakage Current and Maximum Clamping Voltage Curve



Reliability

Items	Standard	Test conditions / Methods	Specifications															
Tensile Strength of Terminals	IEC60068-2-21	Gradually applying the force specified and keeping the unit fixed for 10±1 sec. <table border="1"> <thead> <tr> <th>Terminal diameter (mm)</th> <th>Force (kg)</th> </tr> </thead> <tbody> <tr> <td>0.5 < d ≤ 0.8</td> <td>1.0</td> </tr> <tr> <td>0.8 < d ≤ 1.25</td> <td>2.0</td> </tr> <tr> <td>1.25 < d</td> <td>4.0</td> </tr> </tbody> </table>	Terminal diameter (mm)	Force (kg)	0.5 < d ≤ 0.8	1.0	0.8 < d ≤ 1.25	2.0	1.25 < d	4.0	No visible damage ΔV _{1mA} /V _{1mA} ≤ 5%							
Terminal diameter (mm)	Force (kg)																	
0.5 < d ≤ 0.8	1.0																	
0.8 < d ≤ 1.25	2.0																	
1.25 < d	4.0																	
Bending Strength of Terminals	IEC60068-2-21	Hold specimen and apply the force specified below to each lead. Bend the specimen to 90°, then return to the original position. Repeat the procedure in the opposite direction. <table border="1"> <thead> <tr> <th>Terminal diameter (mm)</th> <th>Force (kg)</th> </tr> </thead> <tbody> <tr> <td>0.5 < d ≤ 0.8</td> <td>0.5</td> </tr> <tr> <td>0.8 < d ≤ 1.25</td> <td>1.0</td> </tr> <tr> <td>1.25 < d</td> <td>2.0</td> </tr> </tbody> </table>	Terminal diameter (mm)	Force (kg)	0.5 < d ≤ 0.8	0.5	0.8 < d ≤ 1.25	1.0	1.25 < d	2.0	No visible damage ΔV _{1mA} /V _{1mA} ≤ 5%							
Terminal diameter (mm)	Force (kg)																	
0.5 < d ≤ 0.8	0.5																	
0.8 < d ≤ 1.25	1.0																	
1.25 < d	2.0																	
Vibration	IEC60068-2-6	Frequency range: 10~55 Hz Amplitude: 0.75mm or 98m/s ² Direction: 3 mutually perpendicular directions, 2hrs each.	No visible damage ΔV _{1mA} /V _{1mA} ≤ 5%															
Solderability	IEC60068-2-20	Solder Temp: 245±5°C Dipping Time: 2±0.5 sec	At least 95% of terminal electrode is covered by new solder															
Resistance to Soldering Heat	IEC60068-2-20	Solder Temp: 260±5°C Dipping Time: 10±1 sec	No visible damage ΔV _{1mA} /V _{1mA} ≤ 5%															
High Temperature Storage	IEC60068-2-2	Ambient Temp: 125±2°C Duration: 1000±24hrs	No visible damage ΔV _{1mA} /V _{1mA} ≤ 5%															
Low Temperature Storage	IEC60068-2-1	Ambient Temp: -40±2°C Duration: 1000±24hrs	No visible damage ΔV _{1mA} /V _{1mA} ≤ 5%															
Damp Heat, Steady State	IEC60068-2-78	The test is divided into two groups . a. 40±2°C , 90~95% RH for 1344±24hrs b. 40±2°C , 90~95% RH, at 10%VDC , 1344±24 hrs	No visible damage ΔV _{1mA} /V _{1mA} ≤ 10% Insulation Resistance ≥ 100MΩ															
High Temperature Load	MIL-STD-202 Method 108	Ambient Temp: 105±2°C Duration: 1000±24hrs Load: Max. Allowable Voltage In AC.	ΔV _{1mA} /V _{1mA} ≤ 10%															
Temperature Cycle	IEC60068-2-14	The conditions shown below shall be repeated 5 cycles <table border="1"> <thead> <tr> <th>Step</th> <th>Temperature (°C)</th> <th>Period (minutes)</th> </tr> </thead> <tbody> <tr> <td>1</td> <td>-40±3</td> <td>30±3</td> </tr> <tr> <td>2</td> <td>Room temperature</td> <td>5±3</td> </tr> <tr> <td>3</td> <td>125±3</td> <td>30±3</td> </tr> <tr> <td>4</td> <td>Room temperature</td> <td>5±3</td> </tr> </tbody> </table>	Step	Temperature (°C)	Period (minutes)	1	-40±3	30±3	2	Room temperature	5±3	3	125±3	30±3	4	Room temperature	5±3	No visible damage ΔV _{1mA} /V _{1mA} ≤ 5%
Step	Temperature (°C)	Period (minutes)																
1	-40±3	30±3																
2	Room temperature	5±3																
3	125±3	30±3																
4	Room temperature	5±3																
8/20uS Surge Life	IEC61051-1	8/20μS waveform, 10 surge currents, unipolar, interval 30secs, amplitude corresponding to max. surge current derating curves for 20μS.	No visible damage ΔV _{b(1mA)} ≤ ±10%															
10/1000μS Surge Life	IEC61051-1	10/1000μS waveform, 10 surge currents, unipolar, interval 2mins, amplitude corresponding to max. surge current derating curves for 1000μS.	No visible damage ΔV _{1mA} /V _{1mA} ≤ 10%															
Voltage Proof	IEC61051-1	Metal balls method, 2500Vac 1 min.	No visible damage															

Soldering Recommendation

Lead-free Wave Soldering Recommendation

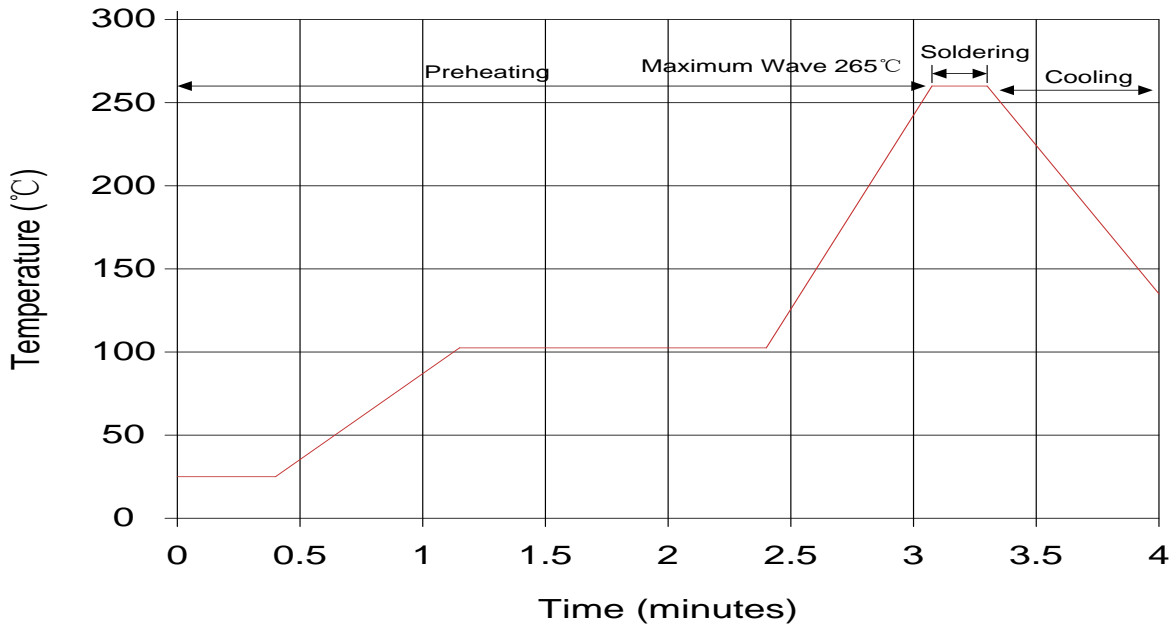

Item	Conditions
Peak Temperature	265°C
Dipping Time	10 seconds (max.)
Soldering	1 time

Recommendation Reworking Conditions with Soldering Iron

Item	Conditions
Temperature of Soldering Iron-tip	360°C (max.)
Soldering Time	3 seconds (max.)
Distance from Varistor	2mm (min.)

Marking Code

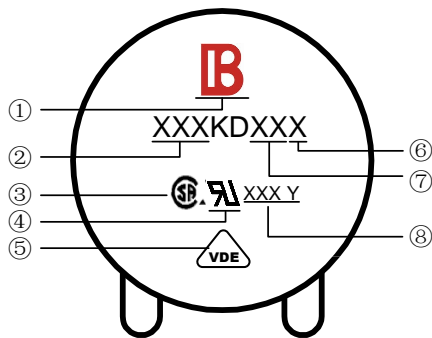

- ① Brightking Logo
- ② Varistor Voltage
- ③ CSA Accreditation Logo
- ④ UL Accreditation Logo
- ⑤ VDE Accreditation Logo
- ⑥ “J” is High Surge Code, no “J” is Standard Surge
- ⑦ Disk Size
- ⑧ Internal control code

Taping Dimensions



Taping Dimensions

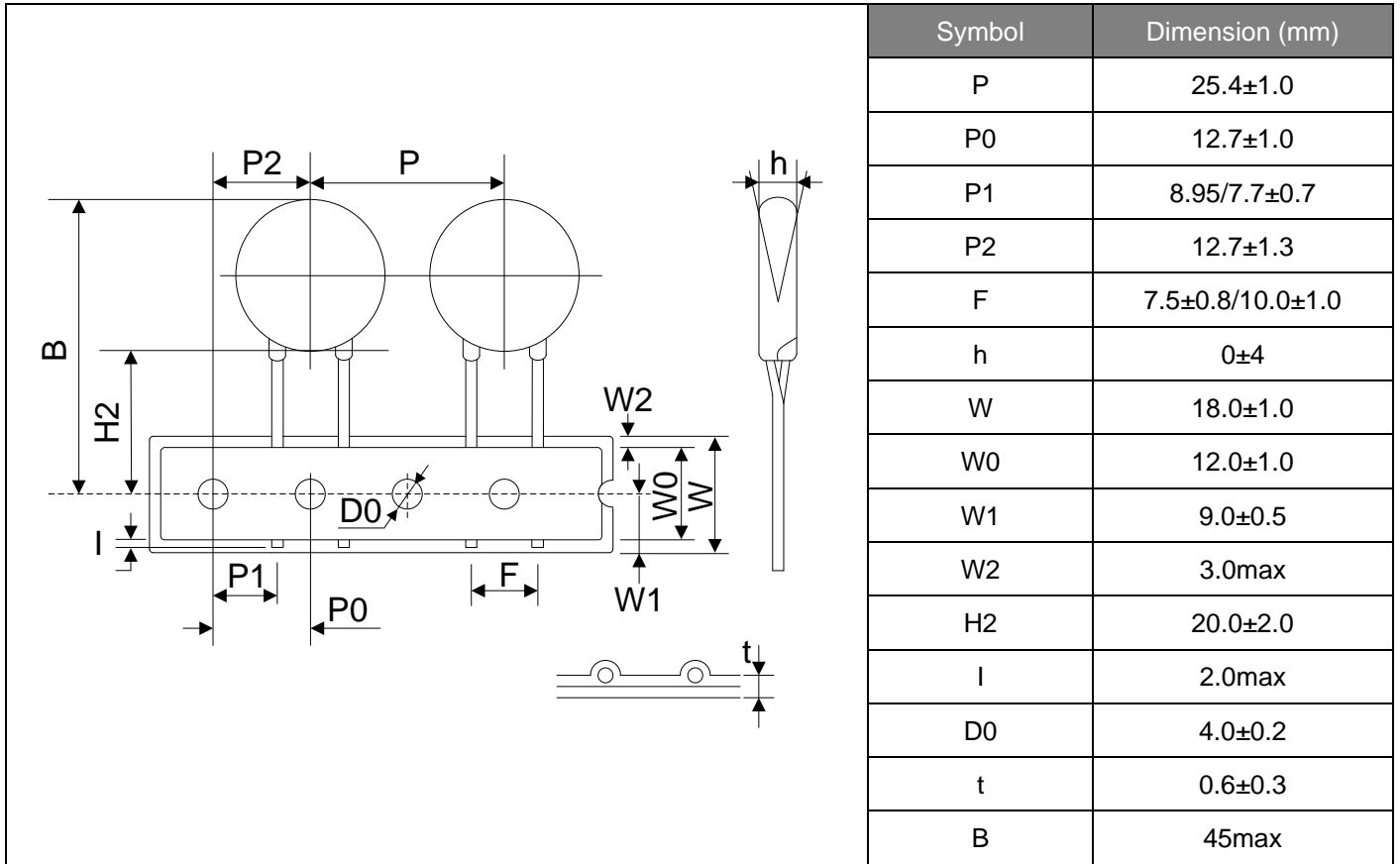

Quantit

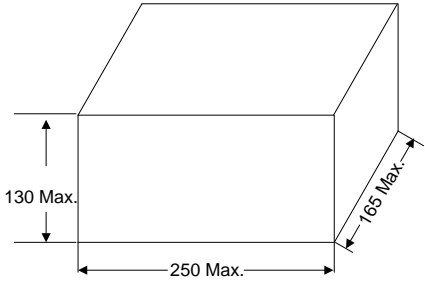
Packaging Dimensions (Unit: mm)	Quantity
In bulk for Terminals Untrimmed Products 	250pcs/bag 4bags/box (180K~301K)
	200pcs/bag 4bags/box (331K~561K)
	150pcs/bag 4bags/box (621K~112K)
	100pcs/bag 4bags/box (122K~182K)

Quantit

Packaging Dimensions (Unit: mm)	Quantity
<p>In bulk for Terminals Trimmed Products</p> 	250pcs/bag 2bags/box (180K~301K)
	200pcs/bag 2bags/box (331K~561K)
	150pcs/bag 2bags/box (621K~112K)
	100pcs/bag 2bags/box (122K~182K)
Packaging Dimensions (Unit: mm)	Quantity
<p>Tape & Box & P0=12.7mm</p> 	400pcs/box (180K~301K)
	300pcs/box (331K~561K)
<p>Tape & Reel & P0=12.7mm</p> 	400pcs/box (180K~301K)
	300pcs/box (331K~561K)

Storage Condition of Products

(I) Storage Conditions :

- 1.Storage Temperature : $-10^{\circ}\text{C} \sim +40^{\circ}\text{C}$
- 2.Relative Humidity : $\leq 80\%RH$
- 3.Keep away from corrosive atmosphere and sunlight.

(II) Period of Storage : 1 year

LEGAL DISCLAIMER

YAGEO, its distributors and agents (collectively, "YAGEO"), hereby disclaims any and all liabilities for any errors, inaccuracies or incompleteness contained in any product related information, including but not limited to product specifications, datasheets, pictures and/or graphics. YAGEO may make changes, modifications and/or improvements to product related information at any time and without notice.

YAGEO makes no representation, warranty, and/or guarantee about the fitness of its products for any particular purpose or the continuing production of any of its products. To the maximum extent permitted by law, YAGEO disclaims (i) any and all liability arising out of the application or use of any YAGEO product, (ii) any and all liability, including without limitation special, consequential or incidental damages, and (iii) any and all implied warranties, including warranties of fitness for a particular purpose, non-infringement and merchantability.

YAGEO products are designed for general purpose applications under normal operation and usage conditions. Please contact YAGEO for the applications listed below which require especially high reliability for the prevention of defects which might directly cause damage to the third party's life, body or property: Aerospace equipment (artificial satellite, rocket, etc.), Atomic energy-related equipment, Aviation equipment, Disaster prevention equipment, crime prevention equipment, Electric heating apparatus, burning equipment, Highly public information network equipment, data-processing equipment, Medical devices, Military equipment, Power generation control equipment, Safety equipment, Traffic signal equipment, Transportation equipment and Undersea equipment, or for any other application or use in which the failure of YAGEO products could result in personal injury or death, or serious property damage. Particularly **YAGEO Corporation and its affiliates do not recommend the use of commercial or automotive grade products for high reliability applications or manned space flight.**

Information provided here is intended to indicate product specifications only. YAGEO reserves all the rights for revising this content without further notification, as long as products are unchanged. Any product change will be announced by PCN.

Looking for pricing, stock, or lifecycle information?

Click below to explore more details on WIN SOURCE:

 [View 390KD20 on WIN SOURCE](#)

 [Yageo Information](#)

Optimize Your Supply Chain with WIN SOURCE Solutions

-  Global Sourcing Solution
-  Obsolete Management
-  Cost Control Management
-  Shortage Management
-  Alternative Solution
-  Excess Inventory Management